

Contents

- 02-03 Introduction
- 04-05 Applications
- 06 Resistance
- 06-09 Principles of Resistance Measurement
- 09-10 Methods of 4 Terminal Connections
- 10-19 Possible Measurement Errors
- 14-18 Choosing the Right Instrument
- 18-24 Application Examples
- 25-33 Useful Formulas and Charts
- 34 Find out more

With resistance measurement,
precision is everything.

This guide is what we know
about achieving the highest
quality measurements possible.

The measurement of very large or very small quantities is always difficult, and resistance measurement is no exception. Values above $1\text{G}\Omega$ and values below 1Ω both present measurement problems.

Cropico is a world leader in low resistance measurement; we produce a comprehensive range of low resistance ohmmeters and accessories which cover most measurement applications. This handbook gives an overview of low resistance measurement techniques, explains common causes of errors and how to avoid them.

We have also included useful tables of wire and

cable characteristics, temperature coefficients and various formulas to ensure you make the best possible choice when selecting your measuring instrument and measurement technique.

We hope you will find this booklet a valuable addition to your toolkit.



APPLICATIONS

There are many reasons why the resistance of material is measured.

Here are a few.

Manufacturers of components

Resistors, inductors and chokes all have to verify that their product meets the specified resistance tolerance, end of production line and quality control testing.

Manufacturers of switches, relays & connectors

Verification that the contact resistance is below pre specified limits is required. This can be achieved at end of production line testing, ensuring quality control.

Cable manufacturers

Must measure the resistance of the copper wires they produce, resistance too high means that the current carrying capability of the cable is reduced; resistance too low means that the manufacturer is being too generous on the cable diameter using more copper than he needs to, which can be very expensive.

Installation & maintenance of power cables, switchgear & voltage tap changers

These require the cable joints and switch contacts to be of the lowest possible resistance

thus avoiding the joint or contact from becoming excessively hot, a poor cable joint or switch contact will soon fail due to this heating effect. Routine preventative maintenance with regular resistance checks ensures the best possible life performances.

Electric motor & generator manufacturers

There is a requirement to determine the maximum temperature reached under full load. To determine this temperature, the temperature coefficient of the copper winding is used. The resistance is first measured with the motor or generator cold i.e. at ambient temperature, the unit is then run at full load for a specified period and the resistance measured again. From the change in resistance value, the internal motor/generator temperature can be determined. Our ohmmeters are also used to measure the individual coils of a motor winding, to ensure there are no short or open circuit turns and that each coil is balanced.

The automotive industry

Requirement to measure the resistance of robot welding cables to ensure that the weld quality

does not deteriorate, i.e. battery lead crimp connectors, air bag detonator resistance, resistance of wiring harness, and quality of crimp connectors on components.

Fuse manufacturers

For quality control, resistance bonding measurements on aircraft and military vehicles, it is necessary to ensure that all equipment installed in aircraft is electrically connected to the air frame, including galley equipment. Tanks and other military vehicles have the same requirements. Producers and users of large electrical currents all need to measure distribution of joint resistance, busbars, and connectors to electrodes for electroplating.

Railway utilities

Including trams and underground railways (Metro) - for the measurement of power distribution cable joints, including the resistance of rail track joints, because the rails are often used for signalling information.

RESISTANCE

Ohm's Law $V = I \times R$ (Volts = Current \times Resistance). The Ohm (Ω) is a unit of electrical resistance equal to that of a conductor in which a current of one ampere is produced by a potential of one volt across its terminals.

Ohm's law, named after its discoverer the German physicist Georg Ohm, is one of the most important, basic laws of electricity. It defines the relationship between the three fundamental electrical quantities: current, voltage and resistance. When a voltage is applied to a circuit containing only resistive elements, current flows according to Ohm's Law, which is shown below.

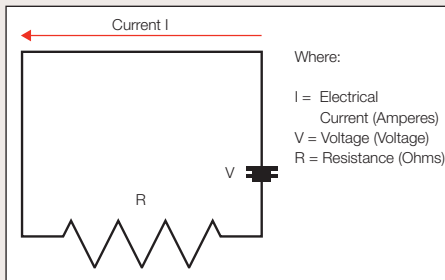

PRINCIPLES OF RESISTANCE MEASUREMENT

Ammeter Voltmeter method

This method goes right back to basics. If we use a battery as our voltage source, a voltmeter to measure the voltage and an ammeter to measure the current in the circuit, we can calculate the resistance with reasonable accuracy.

Whilst this method can provide good measurement results, it is not a practical solution to everyday measurement needs.

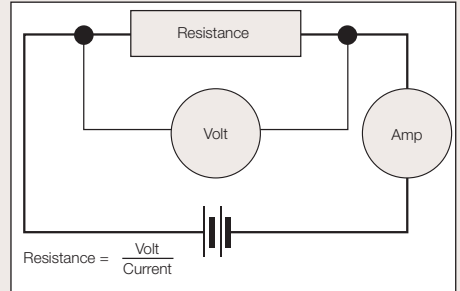

There exists a variety of resistance measuring instruments that will calculate and display the resistance reading without the need for calculations by the user. These measuring instruments will employ either a two wire or a four wire measurement technique.

Kelvin Double Bridge

The Kelvin Bridge is a variation of the Wheatstone bridge which enables low resistances to be measured. The measurement range would typically be $1m\Omega$ to $1k\Omega$ with the smallest resolution of $1\mu\Omega$. The limitations of the Kelvin bridge are:-

1. requires manual balancing
2. sensitive null detector or galvanometer is required to detect balance condition
3. measurement current needs to be reasonably high to achieve sufficient sensitivity

The Kelvin Double Bridge has generally been replaced by digital ohmmeters.

DMM - Two-wire Connection

A simple digital multimeter can be used for

higher values of resistance. They employ the 2 wire method of measurement and are only suitable for measuring values above 100Ω and where high accuracy is not required.

When measuring the resistance of a component (R_x) a test current is forced through the component and the test meter measures the voltage at its terminals. The meter then calculates and displays the resulting resistance and is known as a two-wire measurement. It should be noted that the meter measures the voltage at its terminals and not across the component. As a result of this, the voltage drop across the connection leads is also included in the resistance calculation. Good quality test leads will have a resistance of approximately 0.02Ω per metre. In addition to the resistance of the leads, the resistance of the lead connection will also be included in the measurement and this can be as high as or even higher in value than the leads themselves.

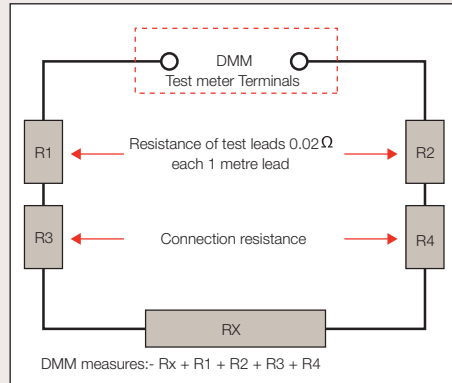

When measuring larger resistance values this additional lead resistance error can be ignored, but as you can see from the chart below, the error becomes significantly higher as the measured value decreases, and totally inappropriate below 10Ω .

TABLE 1
Examples of possible measurement errors

RX	Test lead resistance $R_1 + R_2$	Connection resistance $R_3 + R_4$	Rx measured at DMM terminals = $R_x + R_1 + R_2 + R_3 + R_4$	Error	Error %
1000 Ω	0.04 Ω	0.04 Ω	1000.08 Ω	0.08 Ω	0.008
100 Ω	0.04 Ω	0.04 Ω	100.08 Ω	0.08 Ω	0.08
10 Ω	0.04 Ω	0.04 Ω	10.08 Ω	0.08 Ω	0.8
1 Ω	0.04 Ω	0.04 Ω	1.08 Ω	0.08 Ω	8
100 m Ω	0.04 Ω	0.04 Ω	180 m Ω	0.08 Ω	80
10 m Ω	0.04 Ω	0.04 Ω	90 m Ω	0.08 Ω	800
1 m Ω	0.04 Ω	0.04 Ω	81 m Ω	0.08 Ω	8000
100 $\mu\Omega$	0.04 Ω	0.04 Ω	80.1 m Ω	0.08 Ω	8000

To measure true DC, resistance ohmmeters typically use 4 wire measurement. DC current is passed through the Rx and through the ohmmeter's internal standard. The voltage across the Rx and the internal standard is then measured and the ratio of the two readings is used to calculate the resistance. With this method the current only needs to be steady for the few milliseconds required for the ohmmeter to make both readings, but it requires two measurement circuits. The voltage measured is very small and a μV measurement sensitivity is usually required.

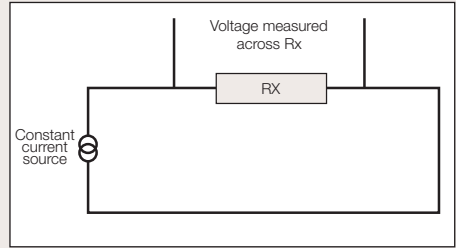

Four wire connection

The four wire (Kelvin) method of measurement is preferred for resistance values below 100Ω , and all Seaward milliohmmeters and microhmmeters use this method. These measurements are made using 4 separate wires. 2 wires carry the current, known as the source or current leads and pass current through the Rx. The other 2 wires known as the sense or potential leads, are used to sense the voltage drop across Rx. Whilst some small current will flow in the sense leads, it is negligible and can be ignored. The volt drop across the ohmmeter's sense terminals is therefore virtually the same as the volt drop across Rx. This method of measurement will produce accurate and consistent results when measuring resistances below 100Ω .

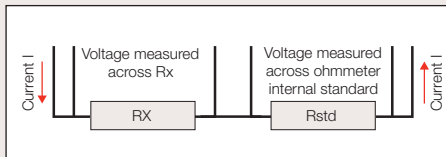

Alternatively a constant current source is used to pass a current through the Rx. The volt drop across the Rx is then measured and the resistance calculated. This method requires only one measurement circuit but the current generator has to be stable under all measurement conditions.

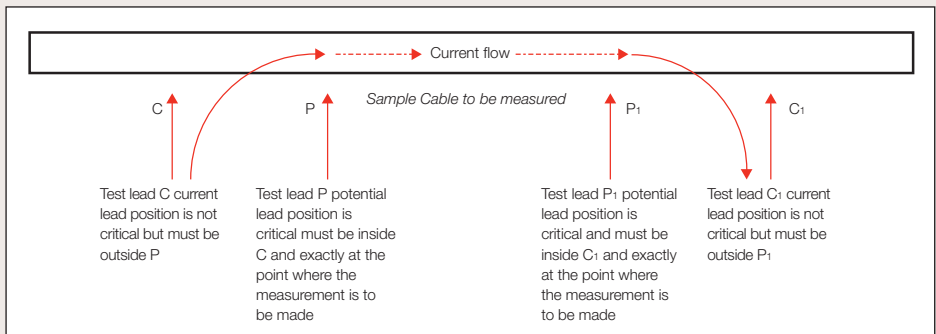

From a measurement point of view this is the best type of connection with 4 separate wires; 2 current (C and C1) and 2 potential (P and P1). The current wires must always be placed outside the potential although the exact placement is not critical. The potential wires must be connected exactly at the points you want to measure between. The measured value will be between the potential points. Whilst this gives the best measurement results it is often not practical. We live in a non perfect world and sometimes small compromises have to be made, Cropico can offer a number of practical measurement solutions.

METHODS OF 4 TERMINAL CONNECTIONS

Kelvin clips

Kelvin clips are similar to crocodile (Alligator) clips but with each jaw insulated from the other. The current lead is connected to one jaw and the potential lead to the other. Kelvin clips offer a very practical solution to making a four terminal connection to wires, busbars, plates etc.

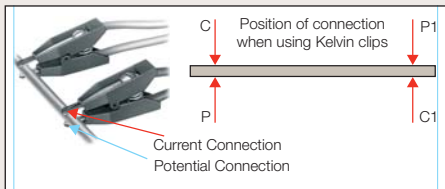

Duplex Handspikes

Handspikes offer another very practical connection solution particularly for sheet material, busbars and where access can be a problem. The handspike consists of two sprung spikes enclosed in a handle. One spike is the current connection and the other is the potential or sense connection.

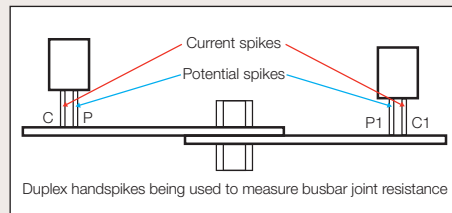

Stacked Lead connection

Sometimes the only practical solution to making a connection to the Rx is to use stacking leads. The current lead is pushed into the back of the potential lead. This method will give small errors

because the measurement point will be where the potential lead connects to the current lead. For measurement of awkward-to-reach samples, this can be the best compromise solution.

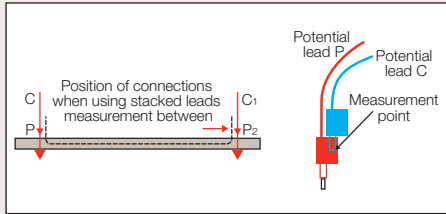

Cable clamps



When measuring cables during manufacture, and for quality control purposes, it is necessary to maintain consistent measuring conditions. The length of the cable sample is normally 1 metre and to ensure that accurate 1 metre lengths are measured, a cable clamp should be used. Cropico offer a variety of cable clamps which will accommodate most cable sizes. The cable to be measured is placed in the clamp and the ends of the cable are clamped in the current terminals. The potential connection points are normally in the form of knife edge contacts which are exactly 1 metre apart.

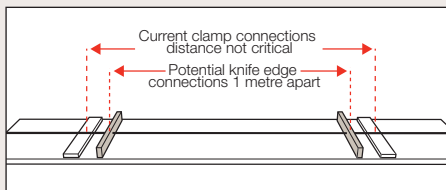

Jigs and fixtures

When measuring other components such as resistors, fuses, switch contacts, rivets etc. the importance of using a test jig to hold the component cannot be emphasised enough. This will ensure that the measurement conditions, i.e. position of measurement leads, are the same for each component which will result in consistent, reliable and meaningful measurements. Jigs often have to be specially designed to suit the application.

POSSIBLE MEASUREMENT ERRORS

There are several possible sources of measurement error associated with low resistance measurements. The most common ones are described below.

Dirty connections

As with all measurements, it is important to ensure that the device you are connecting is clean and free from oxides and dirt. High resistance connections will cause reading errors and may prevent measurements. It should also be noted that some coatings and oxides on materials are good insulators. Anodising has a very high resistance and is a classic example. Be sure to clean off the coating at the connection points. Cropico ohmmeters incorporate a lead error warning which will indicate if the connections are too high in resistance.

Resistance of leads too high

Whilst in theory the four terminal method of measurement is unaffected by lead length, care must be taken to ensure that the leads are not too high in resistance. The potential leads are not critical

and can usually be up to $1k\Omega$ without affecting the measurement accuracy, but the current leads are critical. If the current leads are too high in resistance then the voltage drop across them will result in insufficient voltage across the DUT (Device Under Test) to make a sensible reading. Cropico ohmmeters check this compliance voltage across the DUT and prevent a measurement from being made if it falls too low. A warning display is also provided; preventing the reading, ensuring that false measurements are not carried out. If you need to use long measuring leads, then increase the diameter of the cables to reduce their resistance.

Measurement Noise

As with any type of low voltage measurement, noise can be a problem. Noise is created within test leads when they are in the influence of a magnetic field which is changing or the leads are moving within that field. To minimise this effect, leads should be kept as short as is practical, kept still and ideally shielded. Cropico realises that there are many practical constraints on achieving this ideal, and have therefore designed the circuits within their ohmmeters to minimise and eliminate these effects.

Thermal emf

Thermal emf in the DUT is probably the biggest cause of errors in low resistance measurements. We must first understand what we mean by thermal emf, and how it is generated. Thermal emfs are small voltages which are generated when two dissimilar metals are joined together, forming what is known as a thermocouple junction. A thermocouple will generate an emf depending upon the materials used at the junction and the temperature difference between the hot and the reference, or cold, junction.

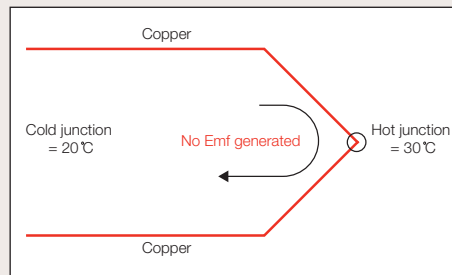
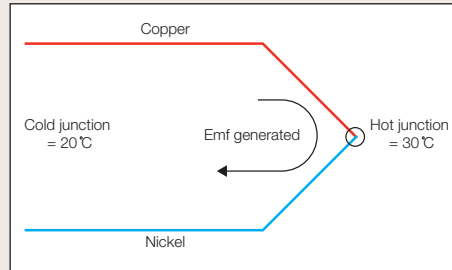

This thermocouple effect will introduce errors into the measurement if steps are not taken to compensate and eliminate these thermal emfs. Cropico microohmmeters and milliohmmeters eliminate this effect by offering an automatic average mode for the measurement, sometimes called the switched DC or average method. A measurement is made with the current flowing in the forward direction then a second measurement is made with the current in the reverse direction. The value displayed is the average of these two measurements. Any thermal emf in the measuring system will add to the first measurement and be subtracted from the second; the resulting average value displayed eliminates or cancels the thermal

emf from the measurement. This method gives the best results for resistive loads but is **not suitable for inductive samples such as motor or transformer windings**. In these cases the ohmmeter is likely to switch current direction before the inductance is fully saturated and the correct measured value will not be achieved.

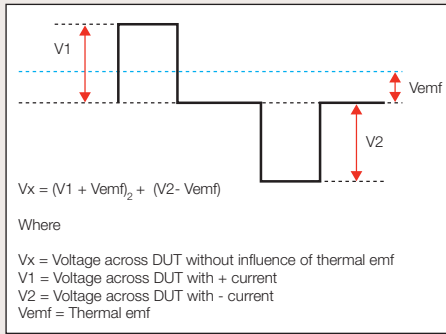

The second method sometimes employed is to connect the current terminals of the ohmmeter together, and with the potential leads connected to the DUT, measure any thermal emf that may be present. This measured value is then stored and deducted from the next measurement with current and potential leads connected to the DUT in the normal way. This is all done automatically when using Crocico ohmmeters in the auto zero mode.

Thermal emfs can be relatively high (100mV) and it is therefore important to carefully select the materials used for making connections. Nickel plated brass, for

example, can produce high emfs when forming junctions with copper. Crocodile clips are often made from nickel plated brass and can produce very high emfs when forming junctions with copper connecting wires.

Inappropriate connection to sample

When making four wire connections it is important to place each wire in the appropriate place. The current and potential leads should always be used in pairs and the current connection outside the potential as shown below.

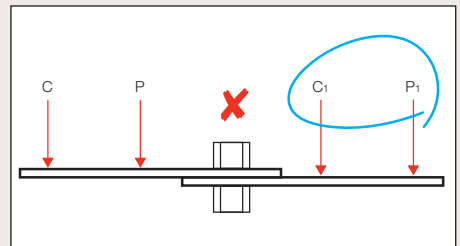
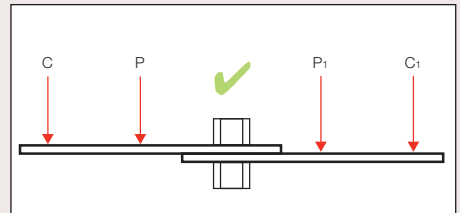

Measurement of joint resistance of 2 busbars

Wrong Test Current

Consideration should always be given to the effect the measurement current will have on the DUT. Devices with a small mass or

constructed with materials that have a high temperature coefficient, such as thin strands of copper wire, will need to be measured with the minimum current available to avoid heating. In these cases a single pulse of current may be appropriate to cause the very minimum of heating. Should the DUT be subject to the influences of thermal emf then the switched current method described earlier is appropriate. The Cropico DO5000 series of ohmmeters have selectable currents from 10% to 100% in 1% steps, plus a single pulse mode and consequently may be configured to suit most applications.

Temperature influences

It is important to be aware that the resistance of most materials will be affected by their temperature. It may be necessary, depending upon the accuracy of measurement required, to control the environment in which the measurement is made, thus keeping the ambient temperature constant. This would be the case when measuring resistance reference standards which are measured in a controlled laboratory at either 20°C or 23°C. For measurements where controlling the ambient temperature is not possible, the ATC (automatic temperature compensation) facility can be used. A temperature probe, connected to the ohmmeter, senses the ambient temperature and the resistance reading is corrected to a reference temperature of 20°C. Two of the most common materials measured are copper and aluminium and their temperature coefficients are illustrated opposite.

The Temperature Coefficient of Copper (near room temperature) is +0.393 % per °C. This means if the temperature increases 1°C the resistance will increase 0.393%. Aluminium is +0.4100 % per °C.

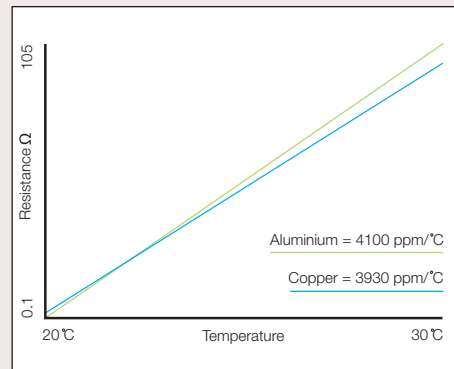

CHOOSING THE RIGHT INSTRUMENT

TABLE 2
Typical Instrument specification chart

Range	Resolution	Measurement Current	Accuracy @ 20 °C ±5 °C, 1 year	Temperature Coefficient / °C
60 Ω	10 mΩ	1 mA	±(0.15% Rdg + 0.05% FS)	40 ppm Rdg + 30 ppm FS
6 Ω	1 mΩ	10 mA	±(0.15% Rdg + 0.05% FS)	40 ppm Rdg + 30 ppm FS
600 mΩ	100 μΩ	100 mA	±(0.15% Rdg + 0.05% FS)	40 ppm Rdg + 30 ppm FS
60 mΩ	10 μΩ	1 A	±(0.15% Rdg + 0.05% FS)	40 ppm Rdg + 30 ppm FS
6 mΩ	1 μΩ	10 A	±(0.2% Rdg + 0.01% FS)	40 ppm Rdg + 30 ppm FS
600 μΩ	0.1 μΩ	10 A	±(0.2% Rdg + 0.02% FS)	40 ppm Rdg + 250 ppm FS

Range:

The maximum reading possible at that setting

Resolution:

The smallest number (digit) displayed for that range

Measurement Current:

The nominal current used by that range

Accuracy:

Uncertainty of the measurement over the ambient temperature range 15 to 25°C

Temperature Coefficient:

The additional possible error below ambient temperature of 15°C and above 25°C

When selecting the best instrument for your application the following should be taken into consideration:-

Accuracy can be better described as the uncertainty of measurement, which is the

closeness of the agreement between the result of a measured value and the true value. It is normally expressed in two parts i.e. a percentage of reading plus a percentage full scale. The accuracy statement should include the temperature range applicable, plus the length of time the accuracy will remain within the indicated limits. **Warning:** some manufacturers give a very high accuracy statement but this is valid only for a short period of 30 or 90 Days. All Cropico ohmmeters specify accuracy for a full 1 year.

Resolution is the smallest increment that the measuring instrument will display. It should be noted that to achieve high measurement accuracy a suitably high resolution is needed, but a high resolution in itself does not indicate that the measurement has a high accuracy.

Example: To measure 1Ω with an accuracy of 0.01% (± 0.0001) requires the measurement to be displayed with a minimum resolution of 100μΩ (1.0001ohms).

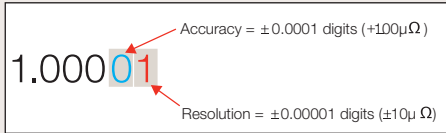

A measured value can also be displayed with a very high resolution but low accuracy i.e. 1Ω measured to an accuracy of 1% but a resolution of $100\mu\Omega$ would be displayed as 1.0001Ω . The only meaningful digits would be 1.0100, the last two digits only showing the fluctuations in the measured values. These fluctuations can be misleading and emphasising any instability of the DUT. A suitable resolution should be selected to ensure a comfortable reading of the display.

Measurement Scale length

Digital measuring instruments display the measured value with displays that have a maximum count, often 1999 (sometimes referred to as 3Ω digit). This means that the maximum value that can be displayed is 1999 and the smallest resolution is 1 digit in 1999. For a measurement of 1Ω the display will read 1.000, a resolution of $0.001m\Omega$. If we wish to measure 2Ω we will need to select a higher range 19.99 Ω full scale and

the value will be displayed as 2.00Ω , a resolution of 0.01Ω . You can therefore see that it is desirable to have a longer scale length than the traditional 1999. The Cropico ohmmeters offer scale lengths up to 6000 count, which would give a displayed value of 2.000, with a resolution of 0.001Ω .

Range Selection

Range selection can be either manual or automatic. Whilst automatic range selection can be very useful when the value of Rx is unknown, the measurement takes longer as the instrument needs to find the correct range. For measurements on a number of similar samples, it is better to manually select the range. In addition to this, the various instrument ranges will measure with different currents which may not be suitable for the device being tested. When measuring inductive samples, such as motors or transformers, the measured value rises as the inductance is saturated until the final value is reached. Automatic range selection should not be used in these applications, as by changing ranges the measuring current is interrupted and its magnitude may also be changed and a final steady reading is unlikely to be achieved.

Scale Length	1.999	19.99	2.000	20.00	3.000	30.00	4.000	40.000
Display reading								
Measured Values	1.000	1.000	1.000	1.000	1.000	1.000	1.000	1.000
	2.000	Range up	2.00	2.000	2.000		2.000	2.000
	3.000	Range up	3.00	Range up	3.00	3.000		3.000
	4.000	Range up	4.00	Range up	4.00	Range up	4.00	4.000

Temperature coefficient

The temperature coefficient of a measuring instrument is important as it can significantly affect the accuracy of the measurement. Measuring instruments are normally calibrated in an ambient temperature of 20 or 23 °C. The temperature coefficient states how the measured accuracy is affected due to variations in ambient temperature.

Current Magnitude and Mode

Selecting an instrument with the appropriate measuring current for the application is important. For example, if thin wires are to be measured, then a high measuring current would heat the wire and change its resistance value. Copper wire has a temperature coefficient of 4% per °C at ambient temperatures, so for a wire with a 1Ω resistance, raising the temperature by 10 °C will increase its value to $10 \times 0.004 = 0.04\Omega$. Some applications, however, benefit from higher currents.

The measurement current mode can also be important. Again, when measuring thin wires, a short measurement pulse of current rather than using a continuous current, will minimise any heating effect. A switched DC measuring mode may also be appropriate to eliminate thermal emf errors, but for measuring motor windings or transformers, a current pulse or switched DC would be inappropriate. Continuous current is required to saturate inductance giving the correct measured value.

Automatic Temperature Compensation

When measuring materials with a high

temperature coefficient, such as copper, the resistance value will increase with temperature. Measurements taken at an ambient temperature of 20 °C will be 0.4% lower than measurements at 30 °C. This can be misleading when trying to compare the values for quality control purposes. To overcome this, some ohmmeters are provided with automatic temperature compensation (ATC). The ambient temperature is measured with a temperature sensor, and the resistance value displayed is corrected for temperature changes referencing the readings to 20 °C.

Measurement speed

The speed of measurement is not normally too important and most ohmmeters will measure at approximately 1 reading per second, but in automated processes such as component selection and production line testing, fast measuring speeds, up to 50 measurements per second, can be desirable. Of course when measuring at these speeds the ohmmeter needs to be remotely controlled using a computer or PLC interfaces.

Remote connections

For remote connection IEEE-488, RS232 or PLC interface may be appropriate. The IEEE-488 interface is a parallel port for the transmission of 8 bits (1byte) of information at a time over 8 wires. It has a transmission speed greater than RS232 but is limited in connection cable distance to 20 metres.

The RS232 interface is a serial port for transmission of data in serial bit format. RS232

has a slower transmission speed than IEEE-488 and requires only 3 lines to transmit data, receive data and signal ground.

The PLC interface allows basic remote control of the ohmmeter by a Programmable Logic Controller or similar device.

Environmental

Consideration should be given to the type of environment in which the ohmmeter is to be used. Is a portable unit needed? Does the construction need to be rugged enough to withstand building site conditions? What temperature and humidity range does it need to operate in?

Verification and calibration

Accuracy verification is the confirmation that the instrument is within its published specification and no adjustment is made. This is accomplished by connecting resistance standards to the ohmmeter and confirming that the instrument measured and displayed values are the same as the standard's certified value.

Calibration is the adjustment of the instrument so that the measured and displayed value is the same as the certified standards value. The Cropico range of ohmmeters stores the calibration data and applies corrections automatically to each displayed value. The advantage of this digital calibration is that there are no mechanical trimmers to adjust,

TABLE
Ohmmeter selection chart

	Ohmmeter ▶	D04000 Series	D04A	D05000 Series	D06	D07	D07e	D07 Plus	D07010	D08000
Automotive	Manufacturers of vehicles and components - motors, alternators, connectors, cable harnesses, switches	■						■		
Aerospace	Bonding resistance (metallization) of aircraft frames and all equipment	■	■			■	■	■	■	
Cable	Measurement of cable resistance			■	■			■		
Calibration Labs	Calibration standards			■						
Drivers and electrical machines	Measurement of motor, generator and transformer resistance		■	■		■		■		■
Distribution Catalogues		■				■	■	■		
Military	Army, Navy, Air force, bonding resistance of vehicles and equipment. Calibration of equipment	■	■	■		■	■	■	■	
Manufacturing	Resistance measurement of components, switches, connectors, crimp joints, fuses etc	■	■	■	■			■	■	
Utilities electrical Gas and Water	Measurement of power cable joints, underground and pylon. Measurement of earthing resistance and contactor resistance in substations	■	■			■	■	■	■	■

and no need to open the instrument as all adjustments are made from the front panel. The calibration data is protected by a password to avoid unauthorised adjustment. For each measurement range the zero and near full scale values are adjusted. The Cropico MTS range of milliohmimeter calibration standards have all the values, including a true 4 terminal zero, housed in one convenient unit. It is important to keep good records of verification and adjustment data so that any long term drifts or problems can be identified.

APPLICATION EXAMPLES

The applications for resistance measuring instruments are very wide ranging. Described below are a few of the more common ones.

Measuring four terminal resistors and standards



A four terminal resistance standard is constructed with 2 current terminals connected to the ends of the resistance element and 2 potential points connected at the adjusted value of the standard. This method of construction ensures repeatable values to be achieved when connecting to the standard's terminals.

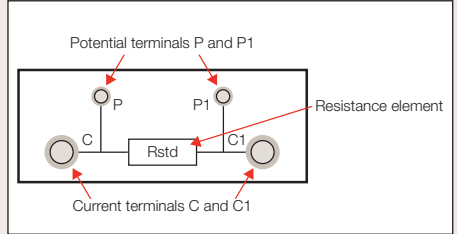

When measuring four terminal resistors and standards it is important that a true four terminal measurement is made. The current and potential measuring leads must be connected to the corresponding terminals on the resistor. Crossing over the current and potential leads will result in an incorrect measurement. Measurements made using the two terminal method, either by connecting to a single pair of terminals or by connecting the source and sense terminals together, will also produce incorrect results.

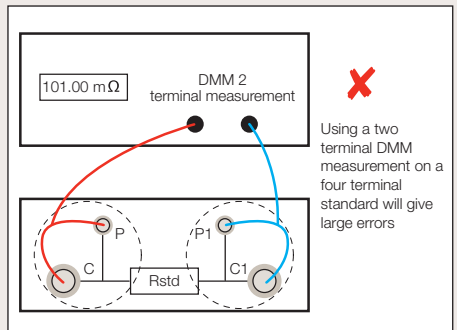

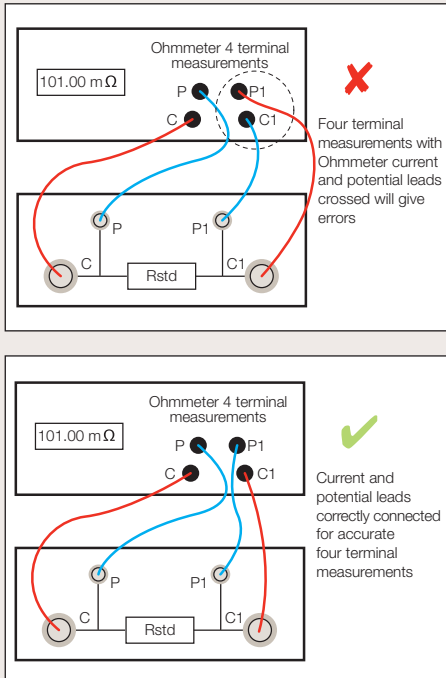

International standards that may apply. It is, however, very important to the manufacturer that the maximum permitted resistance is achieved. From the manufacturer's point of view the lower the resistance value per metre, the larger the diameter of the cable, and hence the greater amount of copper is used. Copper is expensive and is the main contributor to the cable cost, the less copper used the higher the manufacturer's profit.

Accurate and reliable resistance measurement enables the cable manufacturer to achieve the minimum cable diameter, whilst remaining within the declared specification. This is a very powerful argument for good resistance measurements in the cable industry. The accepted method of measuring metre lengths is to use a 1 metre cable clamp.

Method

To ensure meaningful measurements it is necessary to define the measurement conditions. The length of the cable to be measured, the current used to measure the cable and the temperature at which the cable will be measured, all need to be defined.

Wires and cables

During the production process it is necessary to measure the resistance of all electrical wires and cables that are used to distribute power e.g. cable used to wire a house. The resistance needs to be low enough to ensure that the cables will not heat up too much when the maximum rated current is flowing. The higher the resistance, the hotter the cable will become with a set current flowing through it.

Cable manufacturers must ensure that the resistance per metre of the cable conforms to the published specification and to any National or

Cable Length

It is normal practice to measure a metre length of cable and special cable clamps are available for holding the wire. The clamp should include connections for both the current and potential points. The use of a cable clamp eliminates inconsistent readings due to small changes in the length of cable measured. Care should be taken not to stretch the wire when placing it in the clamp, as this will increase the resistance. The clamp should have provision for shielding the wire against draughts which can cause temperature variations. An additional desirable feature of the clamp is the

provision for mounting a temperature sensor adjacent to the cable being measured. The diagram below shows the connections to the wire being measured. Note the current connections are placed on the ends of the cable and the potential connections are inside the current and exactly 1 metre apart.

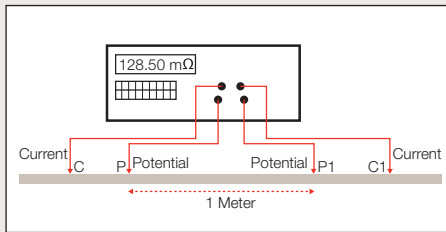

Influence of Temperature

All wires and cables have a temperature coefficient; their resistance value will vary according to the temperature. Some materials have a relatively high temperature coefficient (e.g. copper = 3930ppm/°C) and the measured resistance value will depend upon the temperature. This temperature is influenced by the ambient temperature changes and the heating effect caused by the measurement current. The effect of ambient temperature changes can be compensated for using the ATC

(Automatic Temperature Compensation). This temperature compensation operates by measuring the ambient temperature and automatically correcting the measurement using the material's temperature coefficient to calculate and display the resistance reading referenced to 20°C. By using this method all measured values are relative to the same ambient temperature. To minimise the heating effect of the measuring current is not quite so easy. Ideally the cable should be immersed in a tank of water which is kept at a constant temperature. The water will then dissipate any heat in the cable and keep it at a constant temperature. However this method is expensive, messy, and time consuming and is normally only used for the larger cable diameters. Another solution is to limit the measuring current and the time it is applied, thus keeping the heating effect to a minimum. The Cropico DO5000 microhmmeter is ideally suited to this application as it has the ability to vary the measurement current and reduce the measurement time to a single shot measurement of approx. 0.5 seconds or in FAST MODE to 0.02 seconds.

TABLE 3
Change in resistance with temperature

MATERIAL	TEMP. COEFFICIENT	Resistance @ 20 °C	Resistance @ 23 °C
Copper	3930 ppm / °C	0.001 Ω	0.01279 Ω
Aluminium	4100 ppm / °C	0.001 Ω	0.0133 Ω

Possible Causes of Error

1. Inconsistent measurement conditions. Proper cable clamp not used. Position of potential measurement connections vary.
2. Ambient temperature variations not compensated for, measurement varying due to changes in temperature.
3. Draughts blowing across cable sample causing small changes to cable temperature.
4. Cable being heated by the measuring current causing a continual drift in measurement.
5. Poorly made connections, oxides or dirt on cable producing high resistance at connection points.
6. Plastic coating on cable retains heat in cable.

Measurement solutions



The Cropico DO5000 microhmmeter is the ideal instrument for cable testing; it has the automatic temperature compensation required with the flexibility to set both the cable material's exact temperature coefficient and the temperature which the measurements are referenced to. In addition the DO5000 can operate with a continuous measurement current or a single current pulse. Switched DC measurement mode can also be set.

To ensure that the measurement reference conditions are consistent, Cropico offer a variety of 1 metre cable clamps including one model

complete with temperature controlled water bath. Cable clamps are available for all cable sizes, and when used with the DO5000 microhmmeter, make the perfect measurement solution.

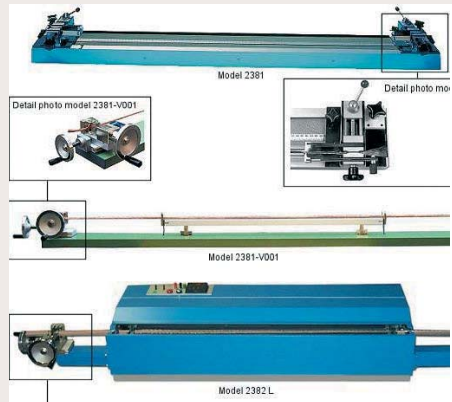

Temperature rise of motors and transformers

All machines produce heat when operating due to internal power losses. It is generally impractical to measure this heat rise with thermocouples or other temperature sensors. The winding construction is normally of copper, which has a known temperature coefficient. By measuring the change in resistance of the winding, the temperature rise can be calculated.

Method

The winding is first measured with the machine at the ambient temperature and the resistance value R_{cold} noted. The machine is then run at full load for a specified period to allow the temperature to stabilise. The unit is switched off, and in the case of motors and generators,

brought to rest and the winding resistance is again noted. It is important to take the first resistance reading as quickly as possible. This is followed by readings at set time intervals with the values being recorded. The measure hold key of the DO5000 is very useful here. Readings can be held on the display and read before triggering the next reading without interrupting the measuring current. From the series of readings taken, it will be possible to draw a cooling curve and extrapolate back to the maximum resistance Rhot of the motor under full load. In this application, the temperature coefficient of the copper winding is used to measure the temperature changes.

$$\text{Temperature rise } \Delta T = \left(\frac{R_{\text{hot}} - R_{\text{cold}}}{R_{\text{cold}} (\text{TC})} \right)$$

Example: A motor field winding has a cold resistance of 1.3245Ω. After running at full load for 8 hours the winding resistance is measured at 1.7654Ω. The temperature coefficient of the copper winding is 3930ppm/°C (0.3930%/°C)

$$\Delta T = \left(\frac{1.7654\Omega - 1.3245\Omega}{1.3245\Omega (0.003930)} \right) = 84.702 \text{ } ^\circ\text{C}$$

The above does not take into account any changes in ambient temperature which can have a significant effect on the resistance readings.

TABLE
Cooling resistance measurement plotted against time

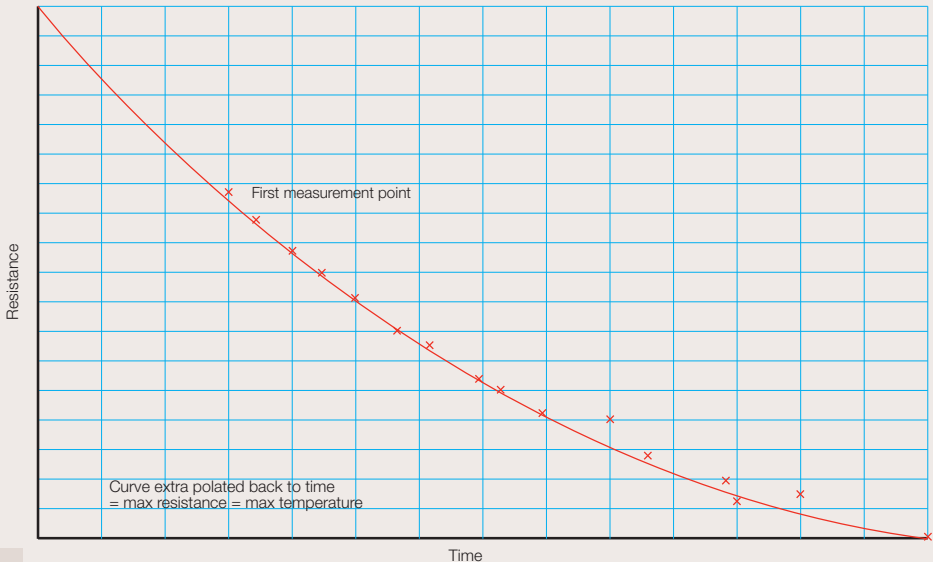

The Cropico ohmmeters have automatic temperature compensation, and by sensing the ambient temperature with an external sensor automatically correct the resistance readings referencing to an ambient temperature of 20°C, thus eliminating any effects ambient temperature changes may have had.

Possible causes of error

1. It is important to make the first measurement as quickly as possible after the machine is disconnected from its power source, and after all current ceases to flow, motors and generators should be brought to a stop condition. **WARNING** damage is likely to occur to the ohmmeter if connected to the machine whilst current is still flowing.
2. Measurements should be made with a stable and continuous measurement current. **DO NOT** use auto ranging, switched DC current or pulse currents as this will give large measuring errors.
3. **DO NOT** switch off the measurement current to take each reading. The Cropico ohmmeters have the ability to freeze the display reading whilst maintaining the measurement current.
4. Make sure connections to the machine are clean and free from oxides. Use copper wire throughout and avoid using connection clips of different materials. The machine will get hot and any thermocouples created within the connections will generate large emfs.
5. **WARNING** Large distribution and power transformers should only be measured with “transformer testing ohmmeters” such as the Cropico model DO8000 which is designed

specifically for this application. These ohmmeters incorporate safety circuits and measuring techniques designed for this application.

Measurement solution



The Cropico Ohmmeter type DO5000 has all the facilities required to measure the temperature rise of machines.

Features include:

1. Automatic temperature compensation
2. Continuous measurement current mode can be selected
3. 2 display hold modes, Mode 1: freezes display reading and does not interrupt the measurement current, Mode 2: freezes the display and disconnects the measurement current.
4. High accuracy 0.03% and long scale length 30000 count
5. Programmable measurement current up to 10Amps to ensure fast saturation of the inductance.

The Cropico Ohmmeter type DO7 Plus also has the ability to calculate and plot the cooling curve,

displaying the temperature rise results in numerical and graphical format, also on screen and via data downloads.

Dry circuit testing - Switch and connector contact resistance

The measurement of switch and connector contact resistance in accordance with DIN IEC 512 and ASTM B539 requires that the open circuit voltage of the measuring device should not exceed 20mV DC. This low voltage avoids the breakdown of any oxides that may be present on the contacts. Ohmmeters in the Cropico range have the facility for limiting this open circuit voltage.

Bonding and earthing resistance (metallisation resistance)

Bonding should not be confused with earthing and is the electrical connection for components to ensure that they have an equal potential. Earthing is the connection of a circuit to the ground earth. Both bonding and earthing connections need to be measured to ensure that a suitably good low resistance joint is achieved and maintained. Typical applications for earthing can be found in electricity distribution substations which have earthing systems for all the equipment, usually in copper. Being made of copper the earthing is often stolen, making regular checks essential. The Cropico range of portable ohmmeters is ideal for these measurements, being rugged in design and unaffected by the high magnetic fields found in these substations.

Aircraft bonding

All metal parts installed in an aircraft must be electrically connected together (Bonded). This includes all parts of the airframe. This electrical bonding of the airframe ensures that the Faraday cage protection is complete. In the case of lightning strikes on the aircraft, it will ensure that all the current from the lightning strike will flow through the aircraft outer skin only. This safeguards the aircraft from the lightning current flowing haphazardly through the aircraft and damaging avionic systems essential to the aircraft safety. Aircraft manufacturers have strict procedures for measuring the bonding resistance, both in production and maintenance. Ohmmeters used to measure this bonding resistance must be accurate, reliable, and able to measure with long leads. Ohmmeters in the Cropico range fulfill these criteria and are used by major aircraft manufacturers and operators.

USEFUL FORMULAS AND CHARTS

TABLE A
SI Unit Prefixes

Factor	Name	Symbol	Factor	Name	Symbol
10 ¹⁵	peta	P	10 ⁻¹	deci	d
10 ¹²	tera	T	10 ⁻²	centi	c
10 ⁹	Giga	G	10 ⁻³	milli	m
10 ⁶	Mega	M	10 ⁻⁶	micro	μ
10 ³	Kilo	k	10 ⁻⁹	nano	n
10 ²	Hecto	h	10 ⁻¹²	pico	p
10 ¹	deka	da	10 ⁻¹⁵	femto	f

TABLE B
Temperature

Known Temperature				Required Temperature	Formulae
Celsius	°C	to	°F	Fahrenheit	$^{\circ}\text{F}=(1.8 \times ^{\circ}\text{C})+32$
Celsius	°C	to	K	Kelvin	$\text{K}=\text{°C}+273.15$
Fahrenheit	°F	to	°C	Celsius	$\text{°C}=(\text{°F}-32)/1.8$
Fahrenheit	°F	to	K	Kelvin	$\text{K}=(\text{°F}+459.67)/1.8$
Kelvin	K	to	°C	Celsius	$\text{°C}=\text{K}-273.15$
Kelvin	K	to	°F	Fahrenheit	$\text{°F}=(1.8 \times \text{K})-459.67$

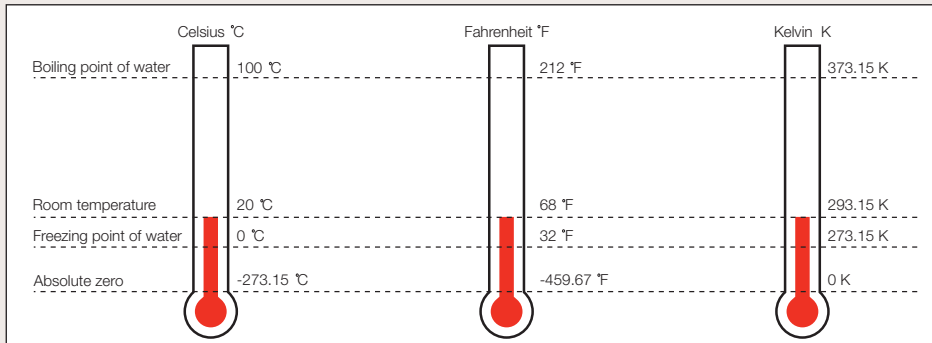

TABLE C**Temperature coefficients conductivity and resistivity of resistance, at 20 °C**

Material	Symbol		Temperature coefficient per °C	Conductivity per Ω-m	Resistivity μΩ-cm
Nickel	Ni	Element	0.005866	1.43×10^7	6.93
Iron	Fe	Element	0.005671	1.03×10^7	9.66
Tungsten	W	Element	0.004403	1.89×10^7	5.28
Aluminium	Al	Element	0.004100	3.77×10^7	2.65
Copper	Cu	Element	0.003930	5.95×10^7	1.67
Silver	Ag	Element	0.003819	6.29×10^7	1.59
Platinum	Pt	Element	0.003729	0.96×10^7	10.5
Gold	Au	Element	0.003715	4.55×10^7	2.21
Zinc	Zn	Element	0.003847	1.69×10^7	5.92
Steel	FeC	Alloy	0.003	0.502×10^7	16.62
Manganin	CuMnNi	Alloy	+/- 0.000015	0.207×10^7	48.21
Constantan	CuNi	Alloy	-0.000074	0.20×10^7	48.20

NOTE: Chart information is taken from multiple sources.

<http://hyperphysics.phy-astr.gsu.edu/hbase/hframe.htm>

http://en.wikipedia.org/wiki/Electrical_resistivity

http://www.ndt-ed.org/EducationResources/CommunityCollege/Materials/Physical_Chemical/Electrical.htm

TABLE D
Wire gauges and resistivity

AWG	Diameter		Area		Copper Resistance		Approximate stranded metric equivalents	AWG	Diameter		Area		Copper Resistance		Approximate stranded metric equivalents
	(inch)	(mm)	(kcmil)	(mm ²)	(Ω/1 km)	(Ω/1000 ft)			(inch)	(mm)	(kcmil)	(mm ²)	(Ω/1 km)	(Ω/1000 ft)	
0000(4/0)	0.46	11.68	211.6	107	0.16*	0.049*		19	0.0359	0.9116	1.29	0.653	26.414	8.051	<24/0.2
000(3/0)	0.4096	10.4	167.8	85	0.2*	0.062*		20	0.032	0.8128	1.02	0.518	33.301	10.15	16/0.2
00(2/0)	0.3648	9.266	133.1	67.4	0.25*	0.077*		21	0.0285	0.7229	0.81	0.41	41.995	12.8	
0(1/0)	0.3249	8.251	105.5	53.5	-0.3281	-0.1		22	0.0253	0.6438	0.64	0.326	52.953	16.14	7/0.25
1	0.2893	7.348	83.69	42.4	0.4*	0.12*		23	0.0226	0.5733	0.51	0.258	66.798	20.36	
2	0.2576	6.544	66.37	33.6	0.5*	0.15*		24	0.0201	0.5106	0.40	0.205	84.219	25.67	1/0.5, 7/0.2, 30/0.1
3	0.2294	5.827	52.63	26.7			196/0.4	25	0.0179	0.4547	0.32	0.162	106.201	32.37	30/0.1
4	0.2043	5.189	41.74	21.2	0.8*	0.24*		26	0.0159	0.4049	0.255	0.129	133.891	40.81	
5	0.1819	4.621	33.1	16.8			126/0.4	27	0.0142	0.3606	0.201	0.102	168.865	51.47	7/0.15
6	0.162	4.115	26.25	13.3	1.5*	0.47*		28	0.0126	0.3211	0.160	0.081	212.927	64.9	
7	0.1443	3.665	20.72	10.5			80/0.4	29	0.0113	0.2859	0.127	0.0642	268.471	81.83	
8	0.1285	3.264	16.52	8.37	2.2*	0.67*		30	0.01	0.2546	0.100	0.0509	338.583	103.2	1/0.25, 7/0.1
9	0.1144	2.906	13.08	6.63			>84/0.3	31	0.0089	0.2268	0.080	0.0404	426.837	130.1	
10	0.1019	2.588	10.38	5.26	3.2772	0.9989	<84/0.3	32	0.008	0.2019	0.063	0.032	538.386	164.1	1/0.2, 7/0.08
11	0.0907	2.305	8.23	4.17	4.1339	1.26	56/0.3	33	0.0071	0.1798	0.050	0.0254	678.806	206.9	
12	0.0808	2.053	6.53	3.31	5.21	1.588		34	0.0063	0.1601	0.040	0.0201	833	260.9	
13	0.072	1.828	5.17	2.62	6.572	2.003	50/0.25	35	0.0056	0.1426	0.032	0.016	1085.958	331	
14	0.0641	1.628	4.10	2.08	8.284	2.525		36	0.005	0.127	0.025	0.0127	1360.892	414.8	
15	0.0571	1.45	3.26	1.65	10.45	3.184	>30/0.25	37	0.0045	0.1131	0.020	0.01	1680.118	512.1	
16	0.0508	1.291	2.59	1.31	13.18	4.016	<30/0.25	38	0.004	0.1007	0.016	0.00797	2127.953	648.6	
17	0.0453	1.15	2.05	1.04	16.614	5.064	32/0.2	39	0.0035	0.08969	0.012	0.00632	2781.496	847.8	
18	0.0403	1.02362	1.62	0.823	20.948	6.385	>24/0.2	40	0.0031	0.07987	0.010	0.00501	3543.307	1080	

The North American wire gauges (AWG gauges) refer to sizes of copper wire. This table corresponds to a resistivity of $\rho = 1.724 \times 10^{-8}$ ohm m for copper at 20°C

*the AWG system states areas of round copper wires in “circular mils”, which is the square of the diameter in mils. 1 mil = 0.001. Conductors larger than 4/0 AWG are generally identified by the area in thousands of circular mils (kcmil), where 1 kcmil = 0.5067 mm²

NOTE: Chart information is taken from <http://hyperphysics.phy-astr.gsu.edu/hbase/Tables/wirega.html>

Resistivity equation

$$P = \frac{RA}{L}$$

- Where P = electrical resistivity ohm – metre
- R = resistance of conductor ohm
- A = cross sectional area of conductor metre²
- L = length of conductor metre

TABLE E**Wire gauge equivalent SWG/AWG**

Number	Imperial Standard Wire Gauge SWG	American Wire Gauge AWG	Number	Imperial Standard Wire Gauge SWG	American Wire Gauge AWG
gauge	inch. dia.	inch. dia.	gauge	inch. dia.	inch. dia.
000000 (7/0)	0.5000	-	25	0.0200	0.0179
000000 (6/0)	0.4640	0.580000	26	0.0180	0.0159
00000 (5/0)	0.4320	0.516500	27	0.0164	0.0142
0000 (4/0)	0.4000	0.460000	28	0.0148	0.0126
000 (3/0)	0.3720	0.409642	29	0.0136	0.0113
00 (2/0)	0.3480	0.364796	30	0.0124	0.0100
0 (1/0)	0.3240	0.324861	31	0.0116	0.0089
1	0.3000	0.289297	32	0.0108	0.0080
2	0.2760	0.257627	33	0.0100	0.0071
3	0.2520	0.229423	34	0.0092	0.0063
4	0.2320	0.2043	35	0.0084	0.0056
5	0.2120	0.1819	36	0.0076	0.0050
6	0.1920	0.1620	37	0.0068	0.0045
7	0.1760	0.1443	38	0.0060	0.0040
8	0.1600	0.1285	39	0.0052	0.0035
9	0.1440	0.1144	40	0.0048	0.0031
10	0.1280	0.1019	41	0.0044	0.0028
11	0.1160	0.0907	42	0.0040	0.0025
12	0.1040	0.0808	43	0.0036	0.0022
13	0.0920	0.0720	44	0.0032	0.0020
14	0.0800	0.0641	45	0.0028	0.0018
15	0.0720	0.0571	46	0.0024	0.0016
16	0.0640	0.0508	47	0.0020	0.0014
17	0.0560	0.0453	48	0.0016	0.0012
18	0.0480	0.0403	49	0.0012	0.0011
19	0.0400	0.0359	50	0.0010	0.0010
20	0.0360	0.0320	51	-	0.00088
21	0.0320	0.0285	52	-	0.00078
22	0.0280	0.0253	53	-	0.00070
23	0.0240	0.0226	54	-	0.00062
24	0.0220	0.0201	55	-	0.00055
25	0.0200	0.0179	56	-	0.00049

NOTE: Chart information is taken from <http://www.simetric.co.uk/siwire.htm>

Outside North America wire sizes for electrical purposes are usually given as the cross sectional in square millimeters. International standard manufacturing sizes for conductors in electrical cables are defined in IEC 60028.

IEC 60288 is the International Electrotechnical Commission's international standard on "Conductors and insulated cables".

Among other things it defines a set of standard wire cross-sections:

International standard wire sizes (IEC 60228)					
0.5 mm ²	0.75 mm ²	1 mm ²	1.5 mm ²	2.5 mm ²	4 mm ²
6 mm ²	10 mm ²	16 mm ²	25 mm ²	35 mm ²	50 mm ²
70 mm ²	95 mm ²	120 mm ²	150 mm ²	185 mm ²	240 mm ²
300 mm ²	400 mm ²	500 mm ²	630 mm ²	800 mm ²	1000 mm ²

NOTE: Chart information is taken from http://en.wikipedia.org/wiki/IEC_60228

Switch DC Mode (Current reversal mode)

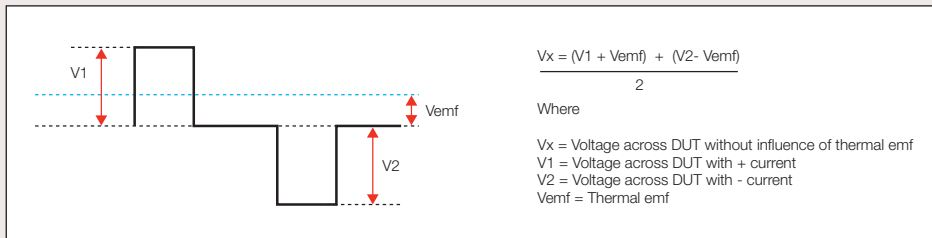

Auto Zero Mode

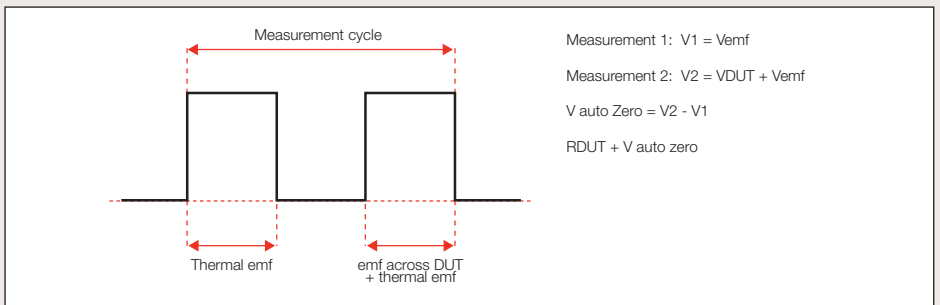
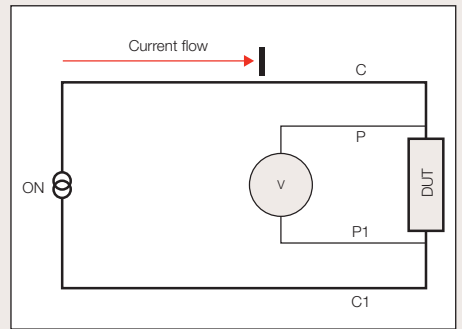
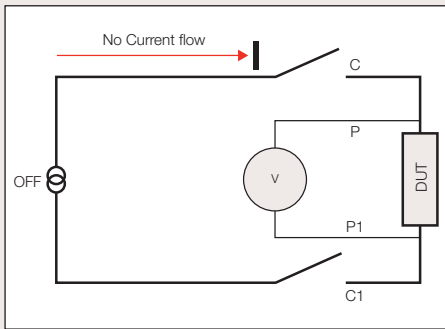

GLOSSARY OF TERMS

Accuracy	The uncertainty of a measurement which is the closeness of the agreement with the actual value.
Ambient temperature	The nominal temperature that surrounds a device or system.
ATC	Automatic temperature compensation.
AWG	American wire gauge, also known as the "Brown and Sharpe" wire gauge, is used in the United States and other countries as a standard method of denoting wire diameter, especially for nonferrous, electrically conducting wire.
Bonding resistance	
Cable	A general term usually used to describe conductors of large diameter.
Cable Clamp	A device for holding 1 metre lengths of cable and providing connections to the cable for current and potential connections.
Conductivity	The reciprocal of electrical resistance.
Cooling Curve	A graph plotting resistance values against time. Usually used when testing motor or transformer to determine the maximum temperature achieved under full load conditions.
DMM	Digital Multimeter.
Duplex Handspikes	Consists of two sprung spikes mounted in a handle. One spike is the current connection and the other spike is the potential.
DUT	Device under test.
Earth resistance	
Emf	Electromotive force is the rate at which energy is drawn from a source that produces a flow of electricity in a circuit; expressed in volts.
Electric current	The rate of charge flow past a given point in an electric circuit, measured in coulombs/second. The unit is the ampere.

Faraday cage	A conducting cage used to shield electronic equipment.
IEC	The International Electrotechnical Commission is the international standards and conformity assessment body for all fields of electrotechnology.
IEEE488	Is a short range digital communications bus. Originally created for use with automated test equipment . Also known as GPIB (general purpose interface bus.)
Inductance	Unit of measure is the Henry (H) and is best described as the behaviour of a coil of wire in resisting any change of electric current through it.
Kelvin	The base unit of temperature in the International System of Units.
Kelvin connection	A 4 wire method of connection which avoids errors due to wire resistance.
Kelvin clips	Similar to crocodile clips but with each jaw electrically isolated. Permits both current and potential leads to be connected with a single clip.
Microhmmeter	A resistance measuring instrument capable of measuring resistance with 1 microhm resolution.
Milliohmmeter	A resistance measuring instrument capable of measuring resistance with 1 milliohm resolution.
Ohm	Defined as the electrical resistance between two points on a conductor when a constant potential difference of 1 volt applied to these points produces in the conductor a current of 1 ampere.
Ohmmeter	A generic name for all 4 terminal resistance measuring instruments.
Potential Leads	The potential leads of a 4 terminal measuring instrument which measure the voltage across the RX. Designated P and P1 or +U and -U depending upon manufacturer.
PLC	Programmable Logic Controller.
ppm	Parts per million.
Precision	The reproducibility and reliability of a measurement.
Range	The maximum reading possible at the selected setting.

Resistance	The degree to which a conductor opposes an electrical current.
Resistivity	The electrical resistance of a uniform rod of unit length and unit cross-sectional area : the reciprocal of conductivity.
Resolution	The smallest increment that a meter will display.
RS232	The RS232 interface is a serial port for transmission of data in serial bit format.
Rx	Resistance of unknown value.
Scale length	The largest value a measuring instrument can display for the range selected.
SI units	The International System of units is a scientific method of expressing magnitude and quantity.
Source Leads	The current leads of a 4 terminal measuring instrument. Designated C and C1 or +I and - I depending on manufacturer.
Stacking lead	A measuring lead with 4mm banana plugs and 4 mm socket allowing one lead to plug into the other.
SWG	Standard Wire gauge.
Thermal emf	The open circuit voltage caused by the difference in temperature between the hot and cold junctions of a circuit made from two dissimilar metals.
Thermocouple	The junction of two dissimilar metals which has a voltage output proportional to the difference in temperature between the hot and cold junctions.
Temperature coefficient	The change increase in conductor resistance per °C rise in temperature.
Wire	A general term used to describe single drawn cylindrical metal and interchangeable with conductor or cable.

Want to know more?
Then contact us.

Cropico
Bracken Hill, South West Industrial Estate,
Peterlee, Co. Durham. SR8 2SW, England
Tel: +44 (0) 191 587 8748
Fax: +44 (0) 191 586 0227
Email: sales@cropico.com
Web: www.cropico.com

Other products available from Cropico:



Resistance standards



Temperature measurement



Resistance decade boxes

NOTES

This material is for information purposes only and is subject to change without notice. Cropico and its associated companies accept no responsibility for any errors or consequential loss or damage which may arise from misinterpretation of the information or procedures.

Cropico, Bracken Hill, South West Industrial Estate,
Peterlee, County Durham, SR8 2SW United Kingdom

Part of  SEAWARD
GROUP

Tel: +44 (0) 191 586 3511 **Fax:** +44 (0) 191 586 0227

Email: sales@cropico.com **Web:** www.cropico.com

Your local Cropico distributor is:

Part No: 998A822

Rev 3