

The Rodin Group

the water friendly company



ION ScaleBuster® an hydrodynamic process with electro-static and galvanic action



ION ScaleBuster – the patented physical water conditioner designed to inhibit and remove scale together with providing corrosion protection



ION ScaleBuster features and benefits

ION ScaleBuster is a physical water conditioner that creates an hydrodynamic process with electro-static and galvanic action. ION ScaleBuster has been installed in industrial, commercial and domestic applications throughout the world for over 25 years.

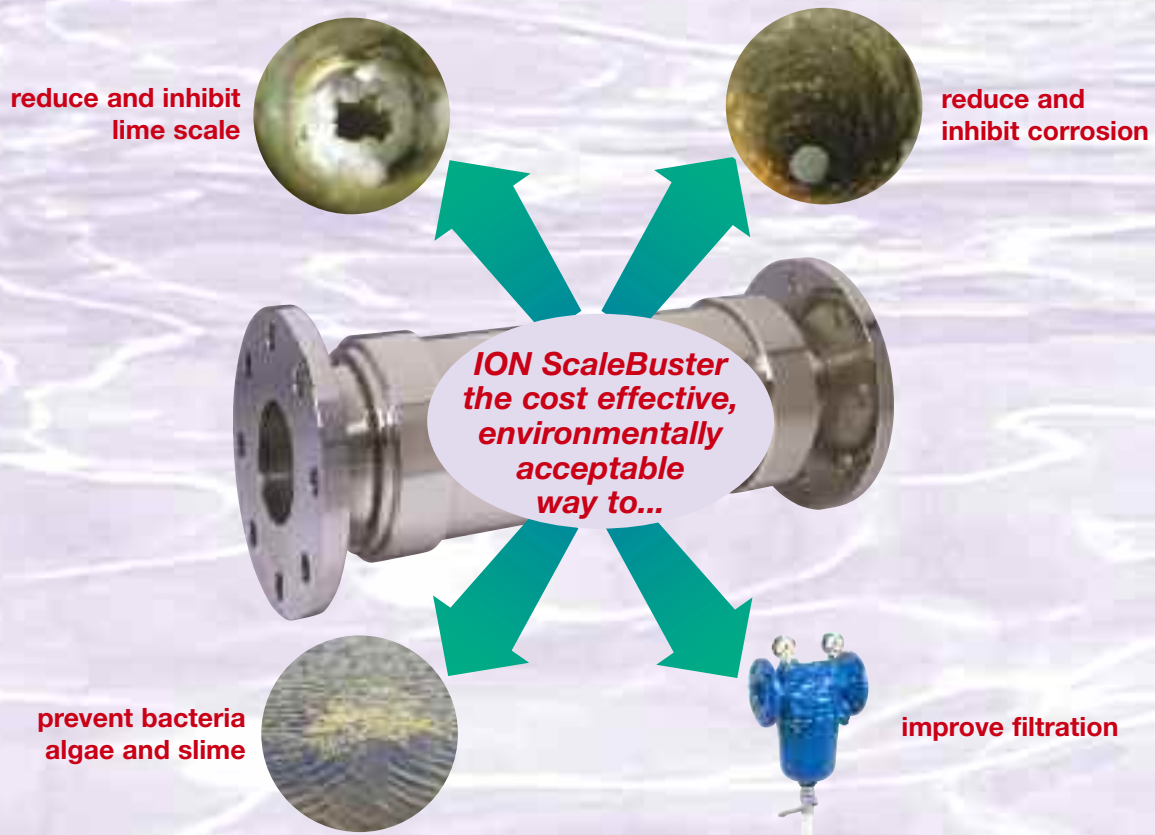

- Uniquely inhibits and removes limescale in hard water areas, but also reduces corrosion in both hard and soft water areas
- No annual running costs - operates without the use of chemicals, magnets or electricity
- Savings in energy and maintenance as the unit is self-cleaning and is 'fit and forget' once installed and earthed correctly
- Maximises heating efficiency
- Extends the operational life of metal pipework and equipment
- Removes the habitat where bacteria grow and hence reduces the risk of Legionella contamination
- Coagulates suspended particles to enhance filtration system efficiency
- Constant water treatment whenever water flows through the unit
- Low internal flow resistance
- Environmentally friendly
- No mechanical moving parts to be replaced
- Compact, easy to install and retro-fit
- Available in all standard pipe sizes – from complete water systems to single point protection
- Proven track record – installed worldwide
- UK designed and patented product
- Manufactured in the UK at a factory with ISO 9001:2000 certification
- WRAS Approved



ION ScaleBuster - the operating principles

ION ScaleBuster uses a proven method of physical water treatment technology having been refined over the years into the current patented version. It is a powerful and unique device which both inhibits and removes the formation of scale and corrosion when fitted as part of a new building design or retro-fitted into an existing installation

ION ScaleBuster is a UK designed and manufactured product which is environmentally and ecologically friendly.

ION ScaleBuster is providing physical water conditioning around the world in a wide range of applications and varying water qualities.

ION ScaleBuster consumes no polluting chemicals or energy once installed

ION ScaleBuster generates water turbulence and applies dynamic pressure within it's structure to force the water through the specially designed multi-channel microjet chambers to maximize the surface area of water treatment for a given pipe size

As ION ScaleBuster generates its own source of electrical energy, water treatment is continuous whilst there is water flow through the unit. Any variations in water pressure, flow rate, or water hardness are easily handled while performance levels remain consistently high

The ION ScaleBuster can be used in a range of water conditions, both potable and non-potable. It can also be applied widely to the protection of manufacturing equipment and within a range of processes

ION ScaleBuster is a 'fit and forget' product which is extremely cost effective as there are no ongoing costs of maintenance, power consumption, chemical supplies or parts to purchase and install

The ION ScaleBuster range is suitable for use in industrial, commercial and domestic applications. Since 1992 it has been installed extensively throughout the UK in schools, hotels, food processing plant, retailer outlets, sports and leisure complexes, local and national government properties and in a wide range of commercial buildings.

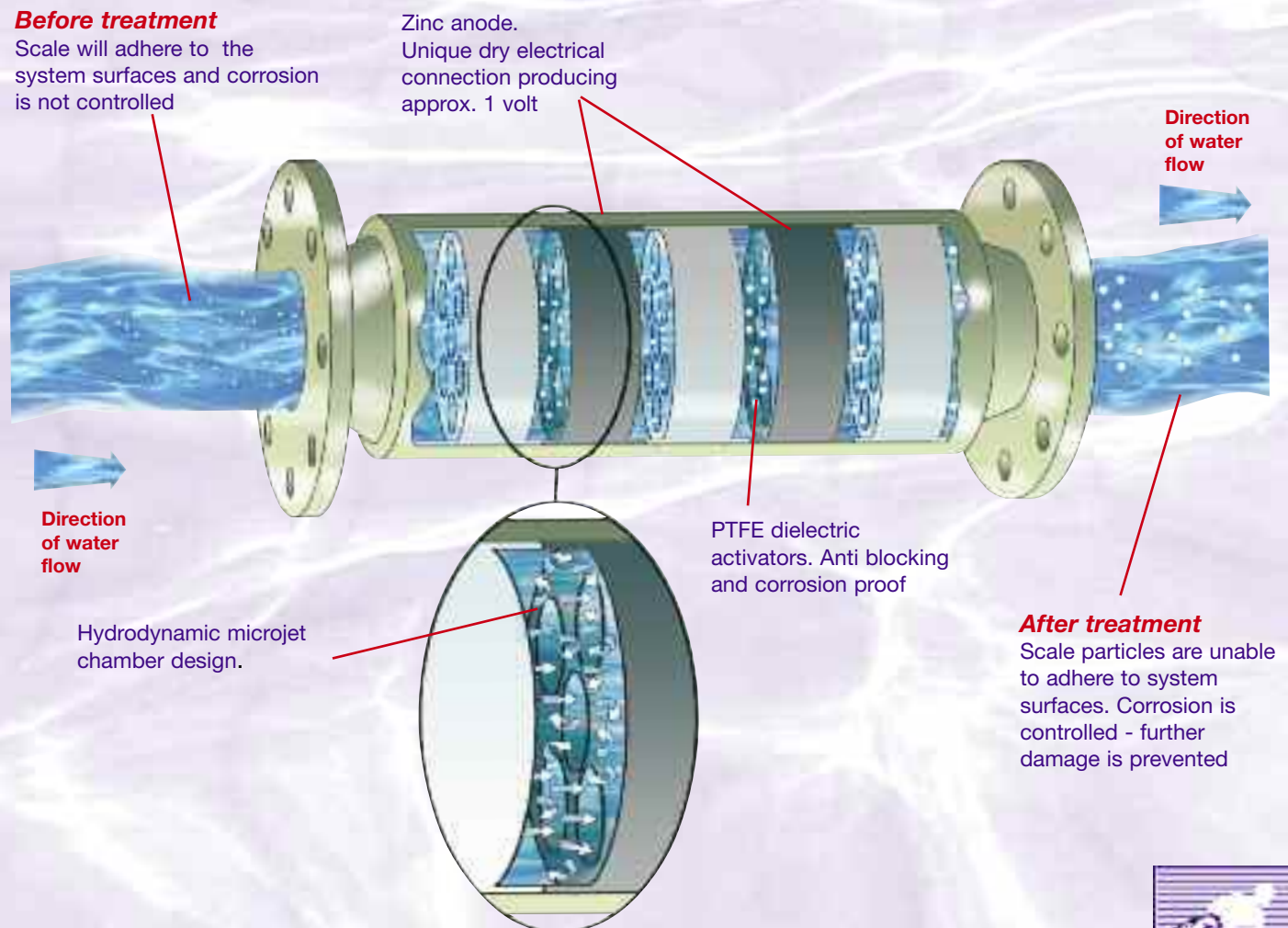

ION ScaleBuster inhibits and removes limescale

LIMESCALE

ION ScaleBuster creates a number of separate effects which combine to produce a physical water conditioner that works effectively over a wide range of conditions and water hardnesses.

ION ScaleBuster, through a unique combination of hydrodynamic action, dielectric charge and a large surface of zinc anode, enables the premature precipitation of calcium carbonate into the water stream by breaking down a significant proportion of the bicarbonates.

HYDRODYNAMIC ACTION

Inside each ION ScaleBuster carefully designed hydrodynamic chambers create microjet turbulence and pressure changes as the water passes through. This effect increases the tendency for water to yield prematurely some of the scale with which it is saturated. Sonic effects created in the water by this hydrodynamic action help to keep the inside of ION ScaleBuster free from fouling due to algae or scale.

DIELECTRIC ACTION

ION ScaleBuster incorporates a large surface area of PTFE, a dielectric material. When water passes over the surface of the dielectric material, electrical energy is generated. This electrical energy passes harmlessly through the stream of water creating a de-stabilising effect, enabling the premature precipitation of calcium carbonate into the water stream by breaking down a significant proportion of bicarbonates.

ANODIC ACTION

ION ScaleBuster also contains a large surface area of zinc, which is bonded to the body of the unit by a unique patented dry connection. This ensures that electrical conductivity is not impaired due to the potential build up of corrosion at the point where the zinc anode meets the body of the unit. The electrolytic cell formed by the zinc and the body allows the slow release of zinc ions into the water stream which act as nuclei for scale formation.

REDUCING EXISTING SCALE AND CORROSION

As a result of concentrating some of the substances that are dissolved within the water, the water becomes less saturated. This in turn enables the less saturated water to start to dissolve existing scale and rust deposits from the walls of pipes and heating appliances. Over a period of time historical deposits that have built up can be flushed from a system.

SCALE AND THE ENVIRONMENT

ION ScaleBuster is an environmentally sound method for combating hard water scale and corrosion since it uses no power or chemicals and requires no maintenance. It uses the kinetic energy created by the water itself moving through the unit to create the forces and effects to provide the conditioning. Although the zinc is sacrificial as part of the process the levels are sufficiently small that the unit will continue to operate effectively without the need for component replacement.



**◀ Typical problems of scaling...
...solved with ION ScaleBuster ▶**



ION ScaleBuster inhibits and removes corrosion

CORROSION

THE PROBLEM

Corrosion is found in water pipes, water treatment devices and various appliances. Corrosion is also a problem for certain grades of stainless steel and can be of even greater concern for old fashioned, galvanised systems. The cost associated with the refurbishment of pipes, systems and equipment is substantial.

Corrosion is the destructive attack of a material by reaction with its environment. Most corrosion is electrochemical in nature hence it follows that electrochemical devices and techniques can be used to inhibit the corrosion process.

THE SOLUTION

The ION ScaleBuster uses a method of action that is electrochemical in nature. The galvanic effects of the special zinc anode offer cathodic protection to pipe-work upstream and downstream of the ION ScaleBuster. The

zinc anode contributes to the precipitating effect on negatively charged particles. The zinc ions play an important part in breaking down existing rust and corrosion deposits through interchange with iron-based compounds.

The ION ScaleBuster precipitates carbonates from solution, therefore, the water becomes less saturated. It is then slowly able to start dissolving old scale and corrosion encrustation in water systems reducing pressure drops caused by restricted flow and saving energy in heating systems and appliances.

Once the existing corrosion is cleared, the unique internationally patented design of the ION ScaleBuster prevents further attack in metal systems by forming a passive layer of magnetite (Fe_3O_4) on the systems surface.

KIST - INDEPENDENT CORROSION REPORT

KIST, the Korean Institute for Science and Technology carried out work on the changes that took place to the surface of iron pipe within a heating pipeline as a consequence of the installation of a ION ScaleBuster for a period of six months.

Prior to the installation the surface of the pipe was examined under an electron microscope where they discovered the surface was coated in irregular shaped iron oxide (rust). Once the ION ScaleBuster had been installed and operated for six months the pipe was re-examined and the rust had changed into regular shaped Magnetite.

The magnetite was providing a protective coating to the inside of the iron pipe-work reducing discolouration of the water. Used over an extended period of time it will prolong the operational life of systems and pipe-work.

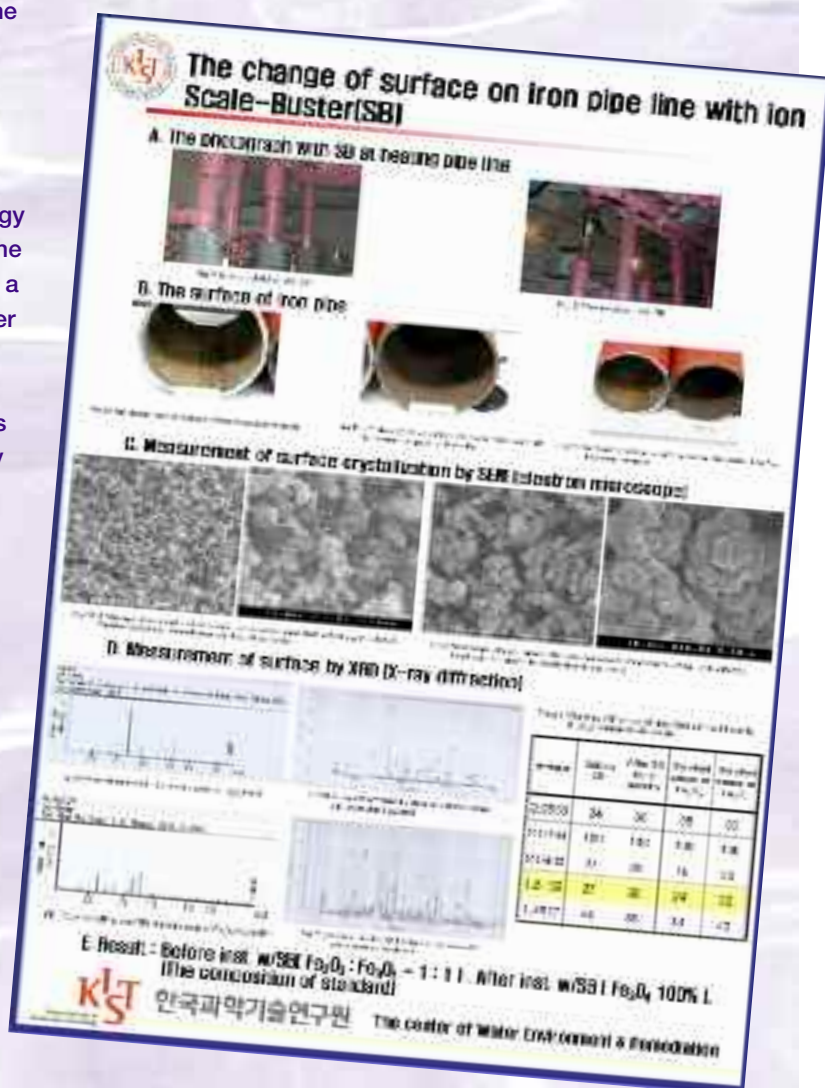

ION ScaleBuster helps prevent Bacteria, Algae & Slime

BACTERIA, ALGAE AND SLIME

The ION ScaleBuster combines several effects, which help to prevent the environment in which bacteria, algae and slime thrive. The most obvious way in which ION ScaleBuster creates hygienic conditions is by removing hard water scale and corrosion from pipes and heating surfaces. It is a well-known fact that scale provides an excellent breeding habitat for bacteria and the creation of bio-films. Clean smooth surfaces prevent habitats from being established in water systems.

The two effects outlined below are little known, but unique to the patented design of the ION ScaleBuster.

The first effect results from the use of dielectric material (PTFE) in specially designed passages and microjet chambers create capacitive effects due to the generation of 'static charge' on the boundary layer of the PTFE. These very large surface areas of PTFE have the effect of neutralizing charged colloidal particles, that until that point are kept in suspension as extremely small particles because they carry a charge. By neutralising these charges, they come out of suspension and flocculate to form larger particles.

The second effect is that the presence of a large surface area of zinc anode causes the release of minute amounts of zinc together with oxides of zinc formed at the cathode (in this case metal pipes and vessels). These also act as coagulants as well as acting as nuclei to initiate the formation of large particles.

The creation of floc has two key benefits that contribute to preventing the growth of bacteria. Firstly the floc absorbs nutrients within the water that are vital for bacteria to thrive and multiply. Secondly by forming larger particles filtration can be used to remove the particles from the water altogether.

ION ScaleBuster has many applications including:

- central heating systems and chiller units
- hot/cold water systems
- protection of production processes

It can also be used to pre-treat irrigation water in ponds and reservoirs to avoid contamination by algae and slime where nutrients are needed to propagate.



ION SCALEBUSTER IMPROVES FILTRATION

ION ScaleBuster's principle effect on hard water is to precipitate greatly enlarged particles within the water stream.

ION ScaleBuster begins by creating calcium carbonate and corrosion particles that coagulate with the organics creating larger particles. These larger particles can be extracted from the water flow by a filtration system.

ION ScaleBuster can also help enhance the existing method of chemical dosing, as the water in the system is kept cleaner, therefore, reducing the quantity of chemicals and extend regenerative systems.

LASER PARTICLE ANALYSIS

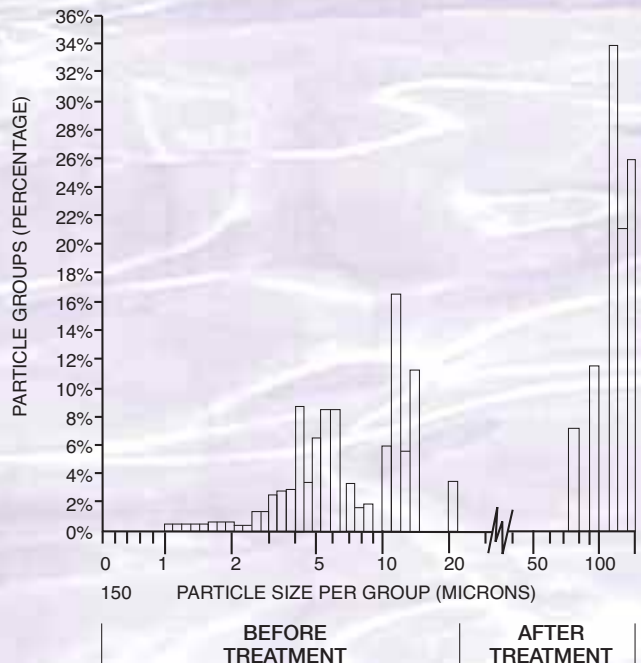

The ION ScaleBuster was tested by the GALAI CIS 100 Computerised Inspection System back on the 18th August 1993. The results supplied by GALAI demonstrated the formation of Large Particle formation.

Only the ION ScaleBuster with its patented ION Active Anode in combination with the Dielectric PTFE turbulence chambers shows these positive results.



ION ScaleBuster questions and answers

WILL ION SCALEBUSTER AFFECT WATER PRESSURE AND FLOW RATES?

The internal configuration of ION ScaleBuster does not noticeably impede the flow or pressure loss with flow rates up to 2 metres per second.

IS THE WATER TREATMENT DEPENDENT ON FLOW RATES?

Unlike many other physical water conditioners, ION ScaleBuster will perform well across a wide range of flow conditions.

DOES TURBULENT FLOW AFFECT THE PERFORMANCE OF ION SCALEBUSTER?

No. The design of ION ScaleBuster creates turbulence within its structure in order to improve the treatment effects.

HOW QUICKLY WILL ION SCALEBUSTER CLEAN A SYSTEM?

The time taken will depend on several factors:

- the internal condition of pipework and appliances
- the thickness of scale deposits
- the distance of affected areas from the ION ScaleBuster.

The actual volume of water passing through ION ScaleBuster will determine the length of time taken to clean scale from the system. However, once installed, ION ScaleBuster will commence its job immediately provided that a water flow is still possible.

WILL ION SCALEBUSTER SOFTEN THE WATER?

No - not in the strict sense of the word 'soften'. However, because some of the dissolved hardness is precipitated from the water, soap and detergent economies are made possible. A 'soft' feel to water is often noticeable.

IS THE TASTE OF WATER AFFECTED?

ION ScaleBuster can improve the taste of water by 'masking' unpleasant flavours such as chlorine as these are absorbed in the precipitated particles.

WILL IT SAVE ENERGY?

Yes. Because ION ScaleBuster will remove existing scale build up on heating surfaces, such as hot water heaters

and tanks, less fuel is required to heat the water. A thickness of scale of only 3 mm can add 25% to energy costs.

WHY IS ION SCALEBUSTER BETTER THAN ALTERNATIVE PHYSICAL WATER CONDITIONERS?

ION ScaleBuster is

- much more versatile
- works well in a wide range of flow conditions
- protects against both corrosion and scale
- is a 'fit and forget' product
- has no maintenance or running costs

WHERE SHOULD ION SCALEBUSTER BE SITUATED IN RELATION TO EQUIPMENT?

Ideally the ION ScaleBuster should be located at least one metre from the equipment to be protected by the device. This allows the growth of precipitated particles of scale to take place before the water reaches heat-producing and scale-forming areas.

HOW LONG DOES THE EFFECT LAST?

ION ScaleBuster has been developed with the size of precipitated particles being a prime consideration. Large particles have a much smaller surface area than the equivalent mass made up of relatively smaller particles. This means they are much slower to re-dissolve in the water and subsequently the treated water has longer lasting effects. Water treated using ION ScaleBuster is likely to continue to do its job of removing old scale deposits from pipe-work for much longer than alternative products, which produce much smaller particles.

WHY IS IT ESSENTIAL TO EARTH THE ION SCALEBUSTER?

ION ScaleBuster causes the precipitation of carbonates arising from the breakdown of dissolved bicarbonates. The change in the chemical structure results in a change in electrical charge. If this charge is not allowed to neutralise then the desired changes may be restricted or limited in duration. In the case of the ION ScaleBuster this is achieved by means of grounding the charge to a suitable earth connection.



ION ScaleBuster range

Industrial Range

| MODEL | PIPE SIZE | | O/A LENGTH-A mm | FLANGE DIA-B mm | BOLT CIRCLE DIA-C* mm | NETT WEIGHT kg |
|------------|-----------|-----|--------------------|--------------------|--------------------------|-------------------|
| | mm | in. | | | | |
| ISB SF 65 | 65 | 2.5 | 445 | 185 | 145 (4 @ 18) | 20.7 |
| ISB SF 75 | 75 | 3 | 445 | 200 | 160 (8 @ 18) | 29 |
| ISB SF 100 | 100 | 4 | 445 | 220 | 180 (8 @ 18) | 46 |
| ISB SF 125 | 125 | 5 | 445 | 250 | 210 (8 @ 18) | 54 |
| ISB SF 150 | 150 | 6 | 520 | 285 | 240 (8 @ 22) | 84 |
| ISB SF 200 | 200 | 8 | 520 | 340 | 295 (12 @ 22) | 96 |

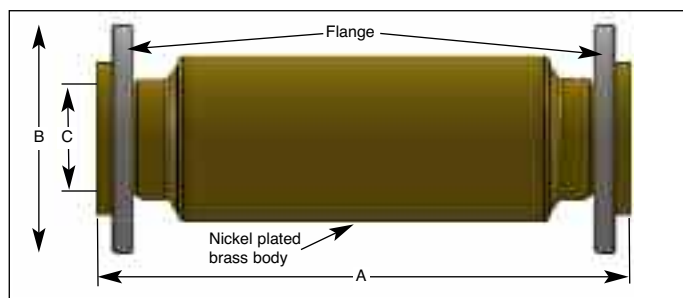

*Number of bolt holes and diameter.
ISO Spec. 7005.3 - PN 16

Building Information Modelling (BIM) files can be downloaded from our website at www.therodingroup.co.uk

Commercial Range

| MODEL | PIPE SIZE | | CONNECTION SIZE BSP | O/A LENGTH mm | O/A DIA. mm | NETT WEIGHT kg |
|-----------|-----------|-------|---------------------|------------------|----------------|-------------------|
| | mm | in. | | | | |
| ISB DN 15 | 15 | 1/2 | 1/2 in. female | 120 | 25 | 0.3 |
| ISB DN 20 | 20 | 3/4 | 3/4 in. female | 157 | 33 | 0.6 |
| ISB C 20 | 20 | 3/4 | 3/4 in. female | 260 | 44 | 2.2 |
| ISB C 25 | 25 | 1 | 1 in. female | 300 | 57 | 3.4 |
| ISB C 32 | 35 | 1 1/4 | 1 1/4 in. female | 330 | 64 | 4.4 |
| ISB C 40 | 40 | 1 1/2 | 1 1/2 in. female | 360 | 69 | 5.5 |
| ISB C 50 | 50 | 2 | 2 in. female | 390 | 87 | 9.0 |

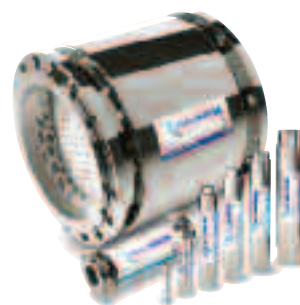
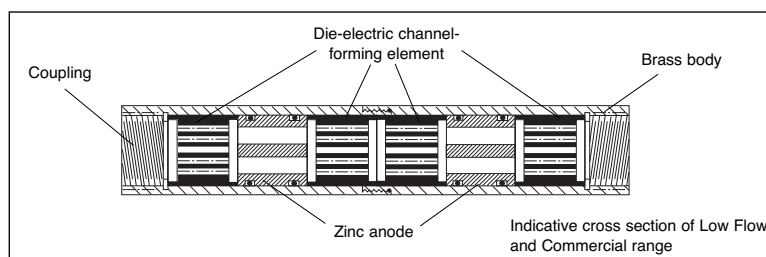

Low Flow Range

| MODEL | MAXIMUM FLOW RATE PER SECOND (L) | CONNECTION SIZE BSP | O/A LENGTH mm | NET WEIGHT kg | TYPICAL APPLICATIONS (Examples) |
|----------|----------------------------------|---------------------|---------------|---------------|---|
| ISB D 03 | 0.03 | 1/2 in. female | 100 | 0.2 | Humidifiers |
| ISB D 06 | 0.07 | 1/2 in. female | 100 | 0.2 | Combi/Steam ovens |
| ISB D 07 | 0.15 | 1/2 in. female | 100 | 0.2 | Vending machines Instant water heaters Electric showers |

The low flow range is designed specifically for applications where water consumption is significantly less than the standard pipe size supplying the appliance. Such products should be used in conjunction with complete building protection.



ION ScaleBuster technical information

Flow Rates

Optimal flow rates should range between 1 to 2 metres per second and therefore performance is not sensitive to fluctuation in rate of flow or variable water pressures. The body is specifically constructed to compensate for such irregularities. **It is recommended that a unit is selected to match the flow rate** as opposed to pipe size (refer to How to Size ION ScaleBuster on this page).

Installation

Where water quality is poor, it is recommended that the product be installed vertically to avoid build up of debris. ION ScaleBuster is designed for use in potable water supplies and apart from certain instances, such as central heating and cooling towers, is best installed in the cold water feed supply lines. Earthing is important to the performance of ION ScaleBuster (see page 11).

Pipe Sizes

Our full range of ION ScaleBuster models ranges from 1/2in (15mm) to 8in (200mm). Sizes outside these models can be produced subject to discussion.

Specials

Units required for conditions exceeding those stated above, please contact distributor.

Body Material

Industrial range

Flanged units are rated at a maximum working pressure of 16 bar. Models with a working pressure of 40 bar are available - details on request. Body and flanges: Nickel plated brass/phosphor bronze to Defence Standard 035 finish.

Optimal Flow Rates

Based on 1 to 2 metres per second mean average velocity.
For short time periods a flow rate up to 3 metres per second is acceptable.

| Industrial Range | | | Commercial Range | | | Low Flow Range | | |
|------------------|-------------------------------|--------------------------------|------------------|-------------------------------|--------------------------------|----------------|-------------|--------------------------------|
| MODEL | SIZE in. | FLOW RATE litres per second | MODEL | SIZE in. | FLOW RATE litres per second | MODEL | SIZE in. | FLOW RATE litres per second |
| ISB SF 65 | 2 ¹ / ₂ | 6.50 | ISB DN 15 | 1/2 | 0.26 | ISB D 03 | 1/2 | 0.03 |
| ISB SF 75 | 3 | 9.00 | ISB DN 20 | 3/4 | 0.50 | ISB D 06 | 1/2 | 0.07 |
| ISB SF 100 | 4 | 16.00 | ISB C 20 | 3/4 | 0.52 | ISB D 07 | 1/2 | 0.15 |
| ISB SF 125 | 5 | 25.00 | ISB C 25 | 1 | 1.00 | | | |
| ISB SF 150 | 6 | 34.00 | ISB C 32 | 1 ¹ / ₄ | 1.60 | | | |
| ISB SF 200 | 8 | 68.00 | ISB C 40 | 1 ¹ / ₂ | 2.40 | | | |
| | | | ISB C 50 | 2 | 4.00 | | | |

Higher flow rates can be achieved. Please refer to pressure loss graphs on page 10

Commercial and Low Flow range

Rated at max. 16 bar working pressure. Constructed of: Brass BS 2874 CZ121; Zinc BS 6561; Polytetrafluoroethylene (PTFE) DEF standard AQAP4 MOD approval.

Special Note

When used in non-potable water applications or in a processing function it may be necessary to have an inline filter prior to ION ScaleBuster and sensitive equipment.

How to size ION ScaleBuster

- Calculate maximum flow rates as per normal procedures - (peak demand)
- Estimate likely average flow rate demand
- Initially size on b), then calculate pressure loss at peak demand a). If pressure loss (at peak demand) is acceptable you have correctly sized ION ScaleBuster
- If peak demand has too high a pressure loss then increase one pipe size until correct balance is achieved.

Warranty

There is a 10 year manufacturer's warranty when used in potable water (see website). For full conditions contact distributor.

Specification

The manufacturer reserves the right to change the specification without prior notice. ION ScaleBuster is designed and manufactured in the UK.



ION ScaleBuster pressure loss statistics

Industrial Range

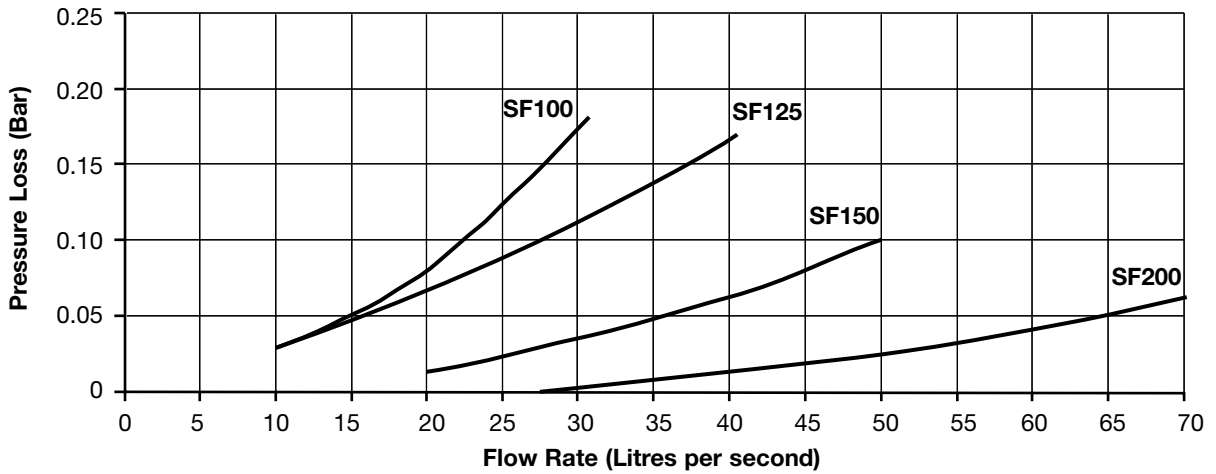

Industrial/Commercial Range

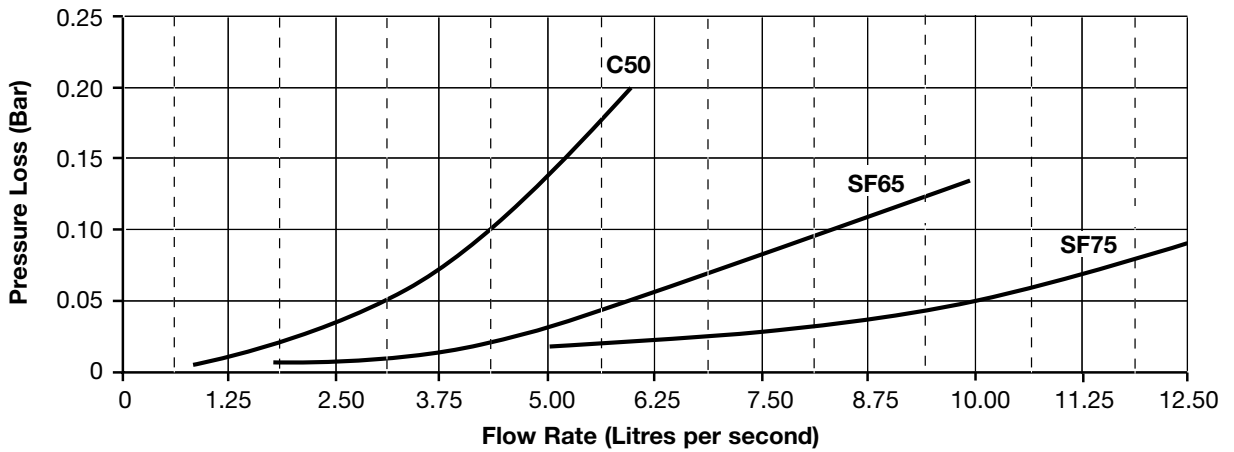

Commercial Range

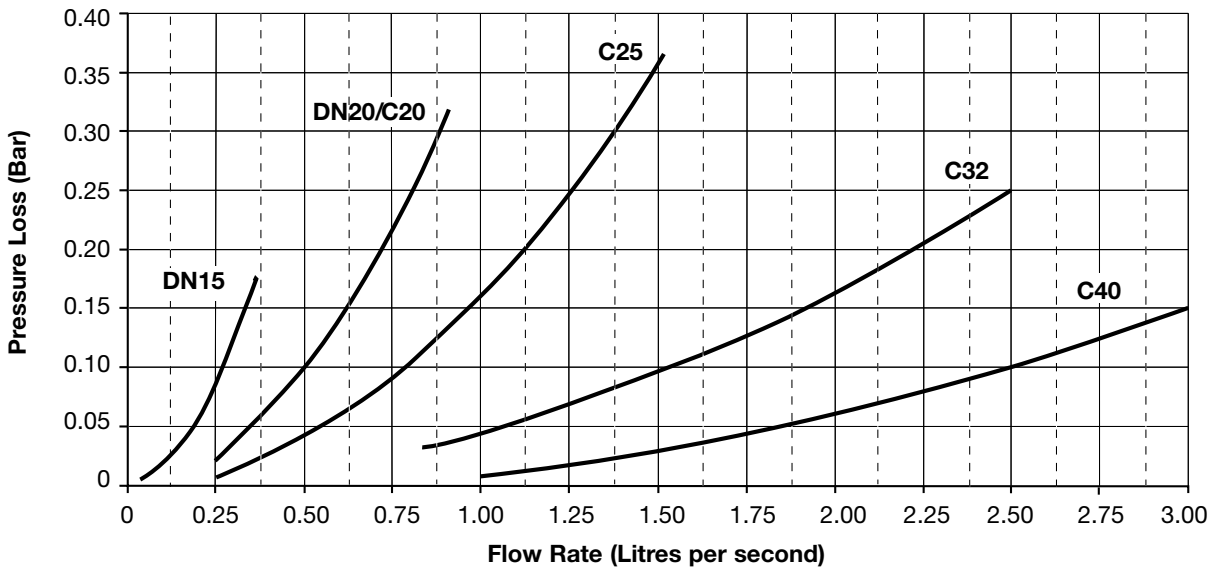

Metric/imperial comparison chart



| | | | | | |
|---------|--------|---------|---------|----------|------------|
| 1.0 bar | 10.0 m | 1000 cm | 100 kpa | 33.00 ft | 396.00 in. |
| 0.1 bar | 1.0 m | 100 cm | 10 kpa | 3.30 ft | 39.60 in. |
| 0.01bar | 0.1 m | 10 cm | 1 kpa | 0.33 ft | 3.96 in. |

ION ScaleBuster installation instructions

Failure to comply will diminish performance and negate product warranty

Where water quality is poor, it is recommended that the ION ScaleBuster be installed vertically to avoid build up of debris and a filter should be considered. In potable water supplies it is best to install ION ScaleBuster in the cold water feed supply lines. In certain instances, such as central heating, hot water returns and cooling towers, ION ScaleBuster should

be installed towards the cool end of the re-circulating system. Care must be taken to ensure that connecting joints requiring applied heat (blow torch) **must not be used** in the vicinity of ION ScaleBuster as the conducted heat will damage the unit's interior.

Electrical earth bonding instructions

ELECTRICAL EARTH BONDING IS ESSENTIAL AND INSTRUMENTAL TO THE ION SCALEBUSTER PERFORMANCE, IN ADDITION TO PROVIDING A SAFE CONTINUITY OF EARTH BONDING FOR OTHER PURPOSES

In gravity fed systems where storage tanks are involved, even if the water is subsequently boosted, it is necessary to cross bond the earthed incoming pipework with the downservice pipework to ensure continuity of earthing. This continuity procedure is also important/necessary where there is a break in the pipework ie metal-to-plastic-to-metal for optimal performance.

Schematic A

Where pipework is metal, properly grounded (earthed) and with no feed back from any stray currents from electrical equipment upstream.

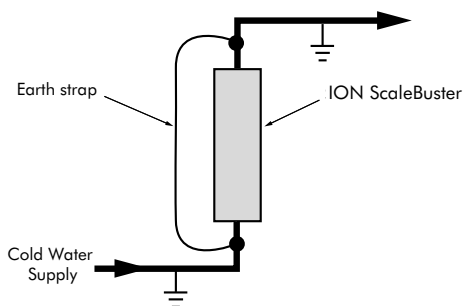

Schematic C

Where pipework is not adequately grounded (earthed).

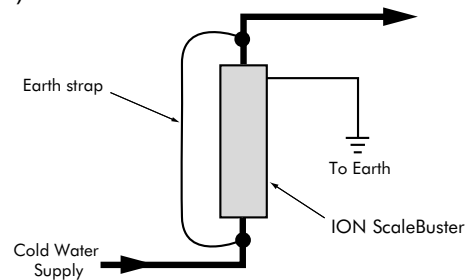

Schematic B

Where pipework is metal, properly grounded (earthed) but with the potential/actual feedback of stray currents from electrical equipment upstream.

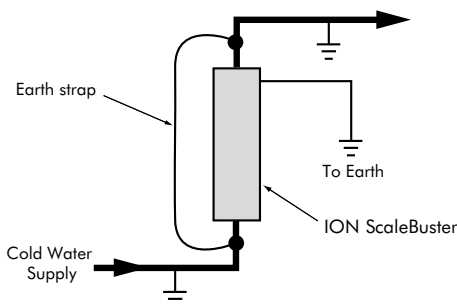

Schematic D

Where ION ScaleBuster is installed into **plastic pipework** it is important that metal pipework is installed both before and after the ION ScaleBuster. The ideal length of pipework **before and after** the ION ScaleBuster should be pipe diameter x 30 wherever possible.

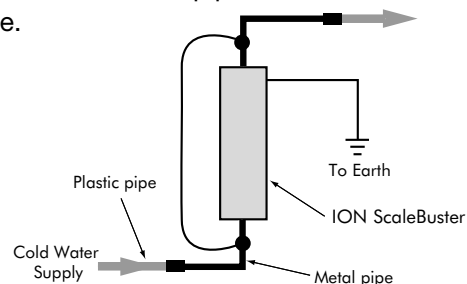

WHEN **PLASTIC PIPES** ARE USED BE SURE TO BOND THE ACTUAL ION SCALEBUSTER TO EARTH



The Rodin Group range

WATER TREATMENT PRODUCTS

HONEYWELL FILTERS



HONEYWELL VALVES



HONEYWELL ELSTER WATER METERS



ION SCALEBUSTER

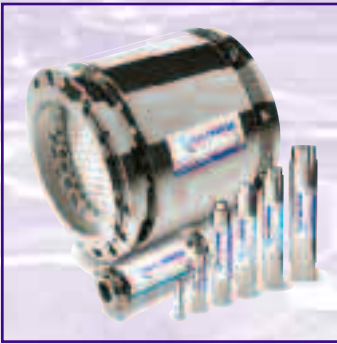

ULTRODIN ULTRA VIOLET



WATER SOFTENERS



WASHROOM PRODUCTS

WATER SAVING AERATORS



WATER SAVING SHOWERS



WATERLESS URINALS



WATER SAVING TAPS



The Rodin Group Ltd
the water friendly company



The Oast, 62 Bell Road
Sittingbourne, Kent, ME10 4HE
T: 01795 423400 F: 01795 436070
E: info@therodingroup.co.uk W: www.therodingroup.co.uk