







Since 1948, SENCO has been synonymous with professional results, quality, increased productivity and craftsmanship.

SENCO is a global brand delivering best in class products in the industrial fastening market including pneumatic, electric, battery and gas powered fastening systems. SENCO pneumatic tools are available in various value propositions from light to heavy duty, to meet extensive end user demands ranging from on-site construction, in-plant manufacturing markets through to the less demanding needs of the occasional user.

The range includes the well-known DuraSpin collated screw driving systems, the unique Fusion cordless pneumatic nailers and pinners and gas powered tools. All SENCO tools support an extensive range of high quality fasteners which meet industry standards and application requirements. Additionally a wide range of high quality compressors, pneumatic screwdrivers and drills complete the SENCO product range.

SENCO is a brand of KYOCERA SENCO Industrial Tools Inc. and is sold by trusted distributors and dealers. In order to excel not only in quality but also in creating new value for all our customers, KYOCERA SENCO strives to be at the forefront of development with its products and services.

To increase the productivity in a modern production environment KYOCERA SENCO developed an innovative Smart Solutions range. With these solutions the production process can be simplified and at the same time improved in terms of accuracy, speed and ergonomics. The solutions are used in combination with powerful SENCO XP hand tools.

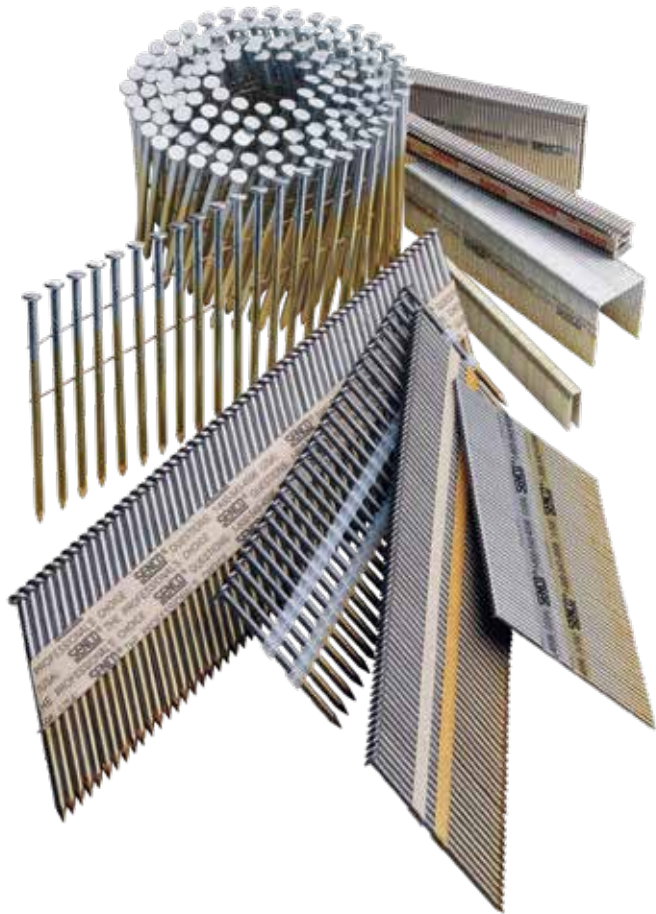

Light Duty	Heavy Duty	XP Heavy Duty
Occasional use	Everyday use	24/7 use

TABLE OF CONTENTS

HIGHLIGHTS

Fusion

F-15, F-16A, F-16S, F-18	5
--------------------------	---



DuraSpin

Cordless DuraSpin	8
Corded DuraSpin	9



Fasteners

Collated screw overview	10
-------------------------	----

Accessories

DS50	14
DS75	14
Adapters DS50, DS75	14
ExTPro	14
DS batteries	15
DS chargers	15
Nose pieces	15
Drive bits in blister	15

Concrete/steel

SAP40XP, SGP40S	17
-----------------	----



Fasteners

Stripnails	17
------------	----

Accessories

Tool accessories	16
------------------	----

INNOVATIONS

Smart Series

	18
--	----



PRODUCT OVERVIEW

Staples

Tools

Pneumatic	XP Heavy duty	22
	Heavy duty	26
	Light duty	28



Fasteners

Fine Wire	29
Medium Wire	31
Heavy Wire	32
High Load	35

Stripnails, Brads and Pins

Tools

Pneumatic First Fix CH nailer/FRH nailer	XP Heavy duty	38
	Heavy duty	39
	Light duty	41
Pneumatic Second Fix Finish nailer XP Heavy duty	XP Heavy duty	43
	Heavy duty	46
	Light duty	47
Cordless First Fix CH nailer/FRH nailer	48	
Cordless Second Fix Finish nailer	49	



Fasteners

First Fix Nails	
Clipped Head Nails	50
Full Round Head Nails	52
Second Fix Nails	
Pins	53
Brads	53
Finish Nails	54

Accessories

Gas tool maintenance	56
Gas tool batteries	56
Fuel cells	56
Fusion batteries	56

Coilnails



Tools

Pneumatic	XP Heavy duty	60
	Heavy duty	61
	Light duty	63
	Pallet	65

Fasteners

Galvanized	68
Bright basic	69
Hot dip	71
Stainless steel A304	72

Clinch Clips



Tools

Pneumatic	Strip tools	76
	Roll tools	76
	Roll tools with blade jam release (ez clear)	76

Fasteners

Clinch Clips	78
--------------	----

Accessories

Adjustable height rotating table	81
Continuous coil clipping system	81

Specials



Tools

Pneumatic / Cordless	DFPXP, F75LXP, F75SXP, FAT25	86
	SC15, TPRO65, GT40FS	87
	BC58, A20, SHT-F	88

Fasteners

Corrugated Fastener	89
T-Nails	89
Fencing Staples	89
Button Cap Staples	89

Screw and Drill Drivers

Tools

Pneumatic	92
-----------	----

COMPRESSORS, SYSTAINER & KITS

Compressors

Maxi	96
Midi	97
Mini	98

Systainer

Compressor PCS1290	100
Compressor Kit PC1010	100
3 in 1 set	100

Starter Kits

PC1010/SLS18Mg	101
PC1010/FIP18Mg	101

ACCESSORIES

Air

	104
--	-----

Hoses

	104
--	-----

Plugs/Couplers

	105
--	-----

REFERENCE

	108
--	-----

CORDLESS PNEUMATIC PERFORMANCE. TRIM ALL DAY.

Experience award-winning cordless convenience in an all-day, everyday trim tool. Fusion tools from SENCO feature a revolutionary cordless air-power technology.

- Instant shot with no ramp-up time
- No hose, compressor or fuel cell
- Drives like a pneumatic tool
- For professional finish and trim

The Fusion F-15 is one of the best cordless nail guns in the market due to its rapid rate of fire, consistent nail-driving performance in any material and its lightweight, slim-handle design.

APPLICATIONS

Finish and trim, fine woodworking, cabinet, furniture, decorative trim

FEATURES

- Rugged aluminum magazine
- Selectable drive switch allows for contact or sequential trigger actuation
- Nose-mounted LED light
- Adjustable belt hook
- Thumbwheel depth-of-drive
- EZ-Clear feature for quickly clearing jams
- Includes storage bag and charger
- All Fusion tools are available as body only version

Fasteners and accessories on page 53 -56



Fusion F-15

FINISH NAILER 1,8MM

SEE ITEM # CHART



34°

Features

- Fusion cordless pneumatic technology
- Adjustable depth of drive
- 18V Li-ion battery
- Selectable trigger
- Includes case

Models and Item Numbers	
Description	Item Code
Fusion FN65DA BF(TF)	5N200IN
Fusion FN65DA BF(TF) + 1 extra battery	5N250IN
Fusion FN65DA BF(TF) UK	5N700IN
Fusion FN65DA BF(TF) + 1 extra battery UK	5N750IN

Fusion F-16S

FINISH NAILER 1,6MM

SEE ITEM # CHART



0°

Features

- Fusion cordless pneumatic technology
- Adjustable depth of drive
- 18V Li-ion battery
- Selectable trigger
- Includes case

Models and Item Numbers	
Description	Item Code
Fusion FN65RHS BF(TF)	6U200IN
Fusion FN65RHS BF(TF) + 1 extra battery	6U250IN
Fusion FN65RHS BF(TF) UK	6U700IN
Fusion FN65RHS BF(TF) + 1 extra battery UK	6U750IN

Fusion F-16A

FINISH NAILER 1,6MM

SEE ITEM # CHART



20°

Features

- Fusion cordless pneumatic technology
- Adjustable depth of drive
- 18V Li-ion battery
- Selectable trigger
- Includes case

Models and Item Numbers	
Description	Item Code
Fusion FN65RHA BF(TF)	5P200IN
Fusion FN65RHA BF(TF) + 1 extra battery	5P250IN
Fusion FN65RHA BF(TF) UK	5P700IN
Fusion FN65RHA BF(TF) + 1 extra battery UK	5P750IN

Fusion F-18

BRAD NAILER 1,2MM

SEE ITEM # CHART



0°

Features

- Fusion cordless pneumatic technology
- Adjustable depth of drive
- 18V Li-ion battery
- Selectable trigger
- Includes case

Models and Item Numbers	
Description	Item Code
Fusion FN55AX BF(TF)	6E200IN
Fusion FN55AX BF(TF) + 1 extra battery	6E250IN
Fusion FN55AX BF(TF) UK	6E700IN
Fusion FN55AX BF(TF) + 1 extra battery UK	6E750IN

Product Reference Chart

TOOL SPECS	Fusion F-15	Fusion F-16A	Fusion F-16S	Fusion F-18
Length	330 mm	279 mm	330 mm	279 mm
Width	76 mm	76 mm	76 mm	76 mm
Height	348 mm	330 mm	330 mm	343 mm
Weight	2,9 kg	2,7 kg	2,7 kg	2,7 kg
Actuation	BF(TF)	BF(TF)	BF(TF)	BF(TF)
Battery	18V Li-ion	18V Li-ion	18V Li-ion	18V Li-ion
Recharge time	45 min	45 min	45 min	45 min
Fuel cell	-	-	-	-
Magazine capacity	110	100	100	110
Warranty	2 yrs	2 yrs	2 yrs	2 yrs
FASTENER SPECS	Fasteners are located on pages 53-56			
Shank	1,8	1,6	1,6	1,2
Range	32-63mm	32-65mm	19-65mm	15-55mm
Angle/Collation	34° Angled Tape Strip	20° Angled glued strip	Straight Glued strip	Straight Glued strip
Series	DA	RH	RX	AX
APPLICATIONS	Finish and trim, baseboard, cabinets and caskets, chair rail, decorative trim, door & window, casing, furniture trim, paneling	All 2nd-fix applications including architrave, dado, skirting, casings, baseboards, frames	Molding and decorative trim, furniture trim, window beading, blind pinning of upholstered and trim panels, rattan, scribe molding, cabinets, drawers and picture frame assembly	Molding and decorative trim, furniture trim, window beading, blind pinning of upholstered and trim panels, rattan, scribe molding, cabinets, drawers and picture frame assembly

DURASPIN

DESIGNED TO MAKE YOU AS PRODUCTIVE AS POSSIBLE

DuraSpin® systems increase screw fastening speeds by more than four times versus loose screws, improving job site productivity by more than 30%.

APPLICATIONS

Whether you choose an integrated tool or use our full line of kits and accessories, you can customize DuraSpin auto-feed screw systems for a variety of applications including drywall, flooring, decking and industrial projects. Check out our collated screws for steel frame construction.

FEATURES

- Patented corner-fit feed system for better screw placement in tight spaces and corners
- Locking depth-of-drive adjustment
- Tool-free adjustable nosepiece
- Easily load 50 screws in less than a second
- Trigger lock, locks in RPM speed
- Long-lasting drive bits with quick-slide release



Highlights



ExTPro

Intelligent and ergonomic solution for flooring jobs. No more kneeling on the ground! Simply attach the extension handle and you can comfortably fasten different floors and even ceilings by guiding the DuraSpin ExTPro along the elements in an upright position.

MAKING HARD WORK EASIER

TOOLS

Cordless DuraSpin

DS5525-18V	8
DS5550-18V	8
DS7525-18V	8

Corded DuraSpin

DS5525-AC	9
DS5550-AC	9
DS7525-AC	9

FASTENERS

Collated screw overview	10
-------------------------	----

ACCESSORIES

DS50	14
DS75	14
Adapters DS50, DS75	14
ExTPro	14
DS batteries	15
DS chargers	15
Nose pieces	15
Drive bits in blister	15

Collated screws

With the Senco collated screw-range you can drive more screws faster and with greater accuracy which results in quicker installations, lower costs, and greater profitability. A collated screw gun like the DuraSpin is able to sink a screw 5 cm below the surface of hard wood.

The New Standard in Professional Auto-Feed Screw Systems

INCREASE JOB SITE PRODUCTIVITY BY 30%!

- DuraSpin Auto-Feed Screw Systems eliminate the need to reach for fasteners and position them on a magnetic screw tip.
- DuraSpin allows for one-handed screw fastening with either hand, freeing the other hand to steady your work.



**Hang
9,5mm drywall
in
60
SECONDS**

DS5525-18V

HEAVY DUTY MACHINE

ITEM 7X2001N (EU), 7X7001N (UK)



Features

- 2500 RPM high torque motor
- Patent pending corner-fit system
- Tool-free screw length adjustment
- Precise depth-of-drive adjustment with depth lock
- Quick slide button bit change
- Reversible belt hook
- Reversible drive
- Includes case

DS5550-18V

HIGH SPEED MACHINE

ITEM 7W2001N (EU), 7W7001N (UK)



Features

- 5000 RPM high speed motor
- Patent pending corner-fit system
- Tool-free screw length adjustment
- Precise depth-of-drive adjustment with depth lock
- Quick slide button bit change
- Reversible belt hook
- Reversible drive
- Includes case

DS7525-18V

MULTI PURPOSE MACHINE

ITEM 7Y2001N (EU), 7Y7001N (UK)



Features

- 2500 RPM high torque motor
- Patent pending corner-fit system
- Patented sliding screw guide
- Tool-free screw length adjustment
- Precise depth-of-drive adjustment with depth lock
- Reversible belt hook
- Reversible drive
- Includes case

Product Reference Chart

TOOL SPECS	DS5525-18V	DS5550-18V	DS7525-18V
Length	381 mm	381 mm	394 mm
Width	86 mm	86 mm	86 mm
Height	241 mm	241 mm	241 mm
Weight	2,6 kg	2,6 kg	2,7 kg
Torque	8Nm	5Nm	8Nm
Speed (RPM)	Variable speed 0-2500	Variable speed 0-5000	Variable speed 0-2500
Power	18V 3Ah Li-ion	18V 3Ah Li-ion	18V 3Ah Li-ion
Recharge time	1 hour	1 hour	1 hour
Screw per charge	up to 1400	up to 1400	up to 1400
Warranty	1 yr	1 yr	1 yr
FASTENER SPECS	Collated screws are located on pages 10-13		
Range	13*-55 mm	13*-55 mm	25-75 mm
Shank Diameter	3,5-4,8 mm	3,5-4,2 mm	3,5-4,8 mm
APPLICATIONS	Drywall to wood or steel studs, sub-floor, cement board, underlayment, sheathing to steel, metal framing	Drywall to wood or steel studs, subfloor, sheathing, cement board, underlayment	Drywall to wood or steel studs, sub-floor, cement board, underlayment, sheathing to steel, metal framing

* 13-25 mm screws require special nosepiece

DS5525-AC

HEAVY DUTY MACHINE

ITEM 7U2001N (EU), 7U7001N (230V, UK), 7U7002N (110V, UK)



Features

- 2500 RPM high torque motor
- Patent pending corner-fit system
- Tool-free screw length adjustment
- Precise depth-of-drive adjustment with depth lock
- Quick slide button bit change
- Reversible belt hook
- Reversible drive
- Includes case

DS5550-AC

HIGH SPEED MACHINE

ITEM 7T2001N (EU), 7T7001N (230V, UK), 7T7002N (110V, UK)



Features

- 5000 RPM high speed motor
- Patent pending corner-fit system
- Tool-free screw length adjustment
- Precise depth-of-drive adjustment with depth lock
- Quick slide button bit change
- Reversible belt hook
- Reversible drive
- Includes case

DS7525-AC

MULTI PURPOSE MACHINE

ITEM 7V2001N (EU), 7V7001N (UK)



Features

- 2500 RPM high torque motor
- Patent pending corner-fit system
- Patented sliding screw guide
- Tool-free screw length adjustment
- Precise depth-of-drive adjustment with depth lock
- Reversible belt hook
- Reversible drive
- Includes case

Product Reference Chart

TOOL SPECS	DS5525-AC	DS5550-AC	DS7525-AC
Length	425 mm	425 mm	438 mm
Width	70 mm	70 mm	70 mm
Height	233 mm	233 mm	233 mm
Weight	2,1 kg	2,1 kg	2,2 kg
Torque	11Nm	7Nm	11Nm
Speed (RPM)	Variable speed 0-2500	Variable speed 0-5000	Variable speed 0-2500
Corded Voltage	230VAC (EU, UK)/110VAC (UK)	230VAC (EU, UK)/110VAC (UK)	230VAC (EU, UK)/110VAC (UK)
Warranty	1 yr	1 yr	1 yr
FASTENER SPECS	Collated screws are located on pages 10-13		
Range	13*-55 mm	13*-55 mm	25-75 mm
Shank Diameter	3,5-5,5 mm	3,5-5,5 mm	3,5-5,5 mm
APPLICATIONS	Drywall to wood or steel studs, sub-floor, cement board, underlayment, sheathing to steel, metal framing	Drywall to wood or steel studs, subfloor, sheathing, cement board, underlayment	Drywall to wood or steel studs, sub-floor, cement board, underlayment, sheathing to steel, metal framing

* 13-25 mm screws require special nosepiece

INDEX

Screw head

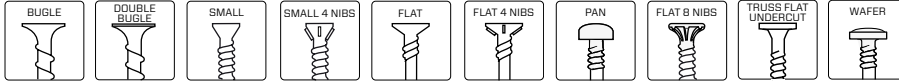

Screw point



Recess



Screw thread

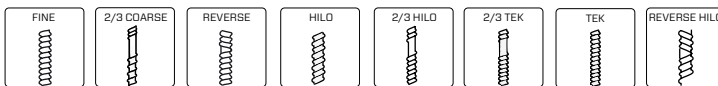

Material/finish



COLLATED SCREW OVERVIEW

Drywall to wood

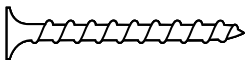

Size	Material/Finish	Head Ø	Art.Nr.
3,9 x 25mm	Phosphate	8,00-8,50	39A25MP
3,9 x 30mm	Phosphate	8,00-8,50	39A30MP
3,9 x 35mm	Phosphate	8,00-8,50	39A35MP
3,9 x 41mm	Phosphate	8,00-8,50	39A41MP
3,9 x 45mm	Phosphate	8,00-8,50	39A45MP
3,9 x 50mm	Phosphate	8,00-8,50	39A50MP
3,9 x 55mm	Phosphate	8,00-8,50	39A55MP
4,5 x 75mm	Phosphate	8,00-8,50	45A75MP
3,9 x 32mm	Clear Zinc	8,00-8,50	39A32MC-5
3,9 x 35mm	Clear Zinc	8,00-8,50	39A35MC-5
3,9 x 42mm	Clear Zinc	8,00-8,50	39A42MC-5
3,9 x 55mm	Clear Zinc	8,00-8,50	39A55MC-5

Drywall to wood

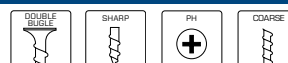
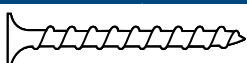

Size	Material/Finish	Head Ø	Art.Nr.
3,9 x 30mm	Clear Zinc	8,00-8,50	39N30MC-5
3,9 x 42mm	Clear Zinc	8,00-8,50	39N42MC-5
3,9 x 55mm	Clear Zinc	8,00-8,50	39N55MC-5

Drywall to wood or light steel (up to 1mm)

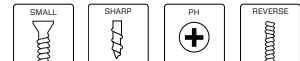
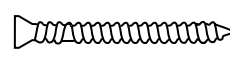

Size	Material/Finish	Head Ø	Art.Nr.
3,9 x 30mm	Clear Zinc	6,00-6,50	39T30MC-5
3,9 x 40mm	Clear Zinc	6,00-6,50	39T40MC-5
3,9 x 50mm	Clear Zinc	6,00-6,50	39T50MC-5

Drywall to light steel (up to 1mm)



Size	Material/Finish	Head Ø	Art.Nr.
3,5 x 25mm	Clear Zinc	8,00-8,50	35P25MC-5
3,5 x 40mm	Clear Zinc	8,00-8,50	35P40MC-5

Drywall to light steel (up to 1mm)



Size	Material/Finish	Head Ø	Art.Nr.
3,5 x 35mm	Phosphate	8,00-8,50	35B35MP
3,5 x 45mm	Phosphate	8,00-8,50	35B45MP
3,9 x 25mm	Phosphate	8,00-8,50	39B25MP
3,9 x 35mm	Phosphate	8,00-8,50	39B35MP
3,9 x 45mm	Phosphate	8,00-8,50	39B45MP
3,9 x 55mm	Phosphate	8,00-8,50	39B55MP

COLLATED SCREWS

Drywall to heavy steel (up to 3mm)

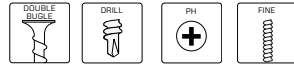
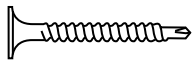

Size	Material/Finish	Head Ø	Art.Nr.
3,5 x 25mm	Phosphate	8,00-8,47	35Q25MP
3,5 x 35mm	Phosphate	8,00-8,48	35Q35MP
3,5 x 40mm	Phosphate	8,00-8,49	35Q40MP
3,5 x 45mm	Phosphate	8,00-8,50	35Q45MP
3,5 x 25mm	Clear Zinc	8,00-8,50	35Q25MC-5
3,5 x 35mm	Clear Zinc	8,00-8,50	35Q35MC-5
3,5 x 40mm	Clear Zinc	8,00-8,50	35Q40MC-5
3,5 x 45mm	Clear Zinc	8,00-8,50	35Q45MC-5

Drywall to wood or light steel (up to 1mm)

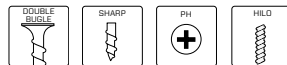

Size	Material/Finish	Head Ø	Art.Nr.
3,9 x 25mm	Phosphate	8,00-8,45	39S25MP
3,9 x 35mm	Phosphate	8,00-8,50	39S35MP
3,9 x 40mm	Phosphate	8,00-8,47	39S40MP
3,9 x 45mm	Phosphate	8,00-8,48	39S45MP
3,9 x 55mm	Phosphate	8,00-8,48	39S55MP
3,9 x 25mm	Clear Zinc	8,00-8,50	39S25MC-5
3,9 x 30mm	Clear Zinc	8,00-8,50	39S30MC-5
3,9 x 32mm	Clear Zinc	8,00-8,50	39S32MC-5
3,9 x 35mm	Clear Zinc	8,00-8,50	39S35MC-5
3,9 x 40mm	Clear Zinc	8,00-8,50	39S40MC-5
3,9 x 42mm	Clear Zinc	8,00-8,50	39S42MC-5
3,9 x 50mm	Clear Zinc	8,00-8,50	39S50MC-5

Gypsum fiber board to light steel (up to 1mm)



Size	Material/Finish	Head Ø	Art.Nr.
3,9 x 30mm	Phosphate	6,70-7,00	39J30MP
3,9 x 45mm	Phosphate	6,70-7,00	39J45MP

Gypsum fiber board to wood or light steel (up to 1mm)

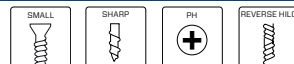
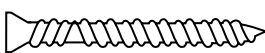

Size	Material/Finish	Head Ø	Art.Nr.
3,9 x 30mm	Clear Zinc	6,00-6,50	39U30MC-5
3,9 x 40mm	Clear Zinc	6,00-6,50	39U40MC-5
3,9 x 50mm	Clear Zinc	6,00-6,50	39U50MC-5

Hard fiber to wood or light steel (up to 1mm)

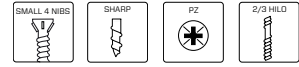
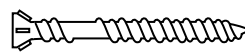

Size	Material/Finish	Head Ø	Art.Nr.
3,9 x 30mm	Clear Zinc	6,70-7,00	39JS30MC
3,9 x 45mm	Clear Zinc	6,70-7,00	39JS45MC

Hard fiber board to light steel (up to 1mm)

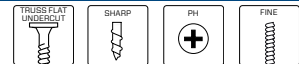
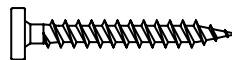

Size	Material/Finish	Head Ø	Art.Nr.
4,2 x 35mm	Phosphate	7,40-7,80	42UM35MP
4,2 x 38mm	Phosphate	7,40-7,80	42UM38MP

General wood to wood

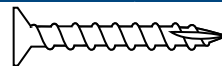

Size	Material/Finish	Head Ø	Art.Nr.
4,0 x 25mm	Clear Zinc	8,00-8,50	40K25MC
4,0 x 30mm	Clear Zinc	8,00-8,50	40K30MC
4,0 x 35mm	Clear Zinc	8,00-8,50	40K35MC
4,0 x 40mm	Clear Zinc	8,00-8,50	40K40MC
4,0 x 45mm	Clear Zinc	8,00-8,50	40K45MC
4,0 x 50mm	Clear Zinc	8,00-8,50	40K50MC
4,0 x 55mm	Clear Zinc	8,00-8,50	40K55MC
4,0 x 60mm	Clear Zinc	8,00-8,50	40K60MC
4,2 x 25mm	Yellow Zinc	8,00-8,50	42K25MY
4,2 x 30mm	Yellow Zinc	8,00-8,50	42K30MY
4,2 x 35mm	Yellow Zinc	8,00-8,50	42K35MY
4,2 x 45mm	Yellow Zinc	8,00-8,50	42K45MY

General wood to wood

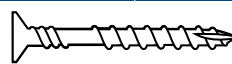

Size	Material/Finish	Head Ø	Art.Nr.
4,2 x 35mm	Yellow Zinc	8,00-8,50	42KS35MY
4,2 x 40mm	Yellow Zinc	8,00-8,50	42KS40MY
4,2 x 45mm	Yellow Zinc	8,00-8,50	42KS45MY
4,2 x 50mm	Yellow Zinc	8,00-8,50	42KS50MY

COLLATED SCREWS

Flooring wood to wood (Chipboard)



Size	Material/Finish	Head Ø	Art.Nr.
4,0 x 25mm	Clear Zinc	8,00-8,50	40H25MC
4,0 x 30mm	Clear Zinc	8,00-8,50	40H30MC
4,0 x 35mm	Clear Zinc	8,00-8,50	40H35MC
4,0 x 40mm	Clear Zinc	8,00-8,50	40H40MC
4,0 x 45mm	Clear Zinc	8,00-8,50	40H45MC
4,0 x 50mm	Clear Zinc	8,00-8,50	40H50MC
4,0 x 55mm	Clear Zinc	8,00-8,50	40H55MC
4,0 x 60mm	Clear Zinc	8,00-8,50	40H60MC
4,2 x 25mm	Yellow Zinc	8,00-8,50	42H25MY
4,2 x 30mm	Yellow Zinc	8,00-8,50	42H30MY
4,2 x 35mm	Yellow Zinc	8,00-8,50	42H35MY
4,2 x 45mm	Yellow Zinc	8,00-8,50	42H45MY

Flooring wood to wood



Size	Material/Finish	Head Ø	Art.Nr.
4,5 x 75mm	Yellow Zinc	8,00-8,50	45F75MY

Flooring wood to wood



Size	Material/Finish	Head Ø	Art.Nr.
4,5 x 60mm	Yellow Zinc	8,00-8,50	45X60MY
4,5 x 65mm	Yellow Zinc	8,00-8,50	45X65MY
4,5 x 70mm	Yellow Zinc	8,00-8,50	45X70MY

Flooring wood to wood (medium)



Size	Material/Finish	Head Ø	Art.Nr.
4,2 x 25mm	Yellow Zinc	7,00-7,50	42R25MY
4,2 x 35mm	Yellow Zinc	7,00-7,50	42R35MY
4,2 x 40mm	Yellow Zinc	7,00-7,50	42R40MY
4,2 x 45mm	Yellow Zinc	7,00-7,50	42R45MY
4,2 x 50mm	Yellow Zinc	7,00-7,50	42R50MY
4,2 x 55mm	Yellow Zinc	7,00-7,50	42R55MY
4,5 x 75mm	Yellow Zinc	7,00-7,50	45R75MY
4,2 x 40mm	Ruspurt II	7,00-7,50	42R40MR
4,2 x 50mm	Ruspurt II	7,00-7,50	42R50MR
4,2 x 55mm	Ruspurt II	7,00-7,50	42R55MR
4,5 x 50mm	Ruspurt II	7,00-7,50	45R50MR
4,5 x 55mm	Ruspurt II	7,00-7,50	45R55MR
4,2 x 50mm	Stainless Steel	7,00-7,50	42R50MS
4,2 x 55mm	Stainless Steel	7,00-7,50	42R55MS
4,2 x 45mm	Weatherex II	7,00-7,50	42R45MW
4,5 x 65mm	Weatherex II	7,00-7,50	45R65MW

Flooring wood to wood



Size	Material/Finish	Head Ø	Art.Nr.
4,2 x 35mm	Yellow Zinc	7,00-7,50	42Z35MY
4,2 x 45mm	Yellow Zinc	7,00-7,50	42Z45MY
4,2 x 55mm	Yellow Zinc	7,00-7,50	42Z55MY

Flooring wood to wood



Size	Material/Finish	Head Ø	Art.Nr.
4,2 x 35mm	Yellow Zinc	7,00-7,50	42RH35MY
4,2 x 40mm	Yellow Zinc	7,00-7,50	42RH40MY
4,2 x 45mm	Yellow Zinc	7,00-7,50	42RH45MY
4,2 x 50mm	Yellow Zinc	7,00-7,50	42RH50MY
4,2 x 55mm	Yellow Zinc	7,00-7,50	42RH55MY
4,5 x 65mm	Yellow Zinc	7,00-7,50	45RH65MY
4,5 x 75mm	Yellow Zinc	7,00-7,50	45RH75MY
4,2 x 40mm	Ruspurt II	7,00-7,50	42RH40MR
4,2 x 50mm	Ruspurt II	7,00-7,50	42RH50MR
4,2 x 55mm	Ruspurt II	7,00-7,50	42RH55MR
4,5 x 65mm	Ruspurt II	7,00-7,50	45RH65MR
4,5 x 75mm	Ruspurt II	7,00-7,50	45RH75MR
4,2 x 35mm	Stainless Steel	7,00-7,50	42RH35MS
4,2 x 40mm	Stainless Steel	7,00-7,50	42RH40MS
4,2 x 45mm	Stainless Steel	7,00-7,50	42RH45MS
4,2 x 50mm	Stainless Steel	7,00-7,50	42RH50MS
4,2 x 55mm	Stainless Steel	7,00-7,50	42RH55MS
4,5 x 75mm	Stainless Steel	7,00-7,50	45RH75MS

Decking wood to wood



Size	Material/Finish	Head Ø	Art.Nr.
4,5 x 50mm	Stainless Steel	8,00-8,50	45D50MSA
4,5 x 65mm	Stainless Steel	8,00-8,50	45D65MSA
4,5 x 75mm	Stainless Steel	8,00-8,50	45D75MSA

Flooring/decking wood to wood (soft)



Size	Material/Finish	Head Ø	Art.Nr.
4,2 x 50mm	Weatherex II	8,00-8,50	42W50MW
4,2 x 55mm	Weatherex II	8,00-8,50	42W55MW
4,5 x 65mm	Weatherex II	8,00-8,50	45W65MW
4,5 x 75mm	Weatherex II	8,00-8,50	45W75MW
4,2 x 50mm	Yellow Zinc	8,00-8,50	42W50MY
4,2 x 55mm	Yellow Zinc	8,00-8,50	42W55MY
4,5 x 65mm	Yellow Zinc	8,00-8,50	45W65MY
4,5 x 75mm	Yellow Zinc	8,00-8,50	45W75MY

COLLATED SCREWS

Flooring/decking wood to wood (soft)

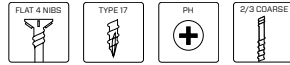
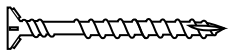

Size	Material/Finish	Head Ø	Art.Nr.
4,2 x 35mm	Yellow Zinc	8,00-8,50	42Y35MY
4,2 x 40mm	Yellow Zinc	8,00-8,50	42Y40MY
4,2 x 50mm	Yellow Zinc	8,00-8,50	42Y50MY
4,2 x 55mm	Yellow Zinc	8,00-8,50	42Y55MY

Steel to steel (up to 3MM)



Size	Material/Finish	Recess	Head Ø	Art.Nr.
5,5 x 19mm	Clear Zinc	PH2	7,68-8,18	55WP19MC
5,5 x 19mm	Clear Zinc	SQ2	7,68-8,18	55WS19MC
5,5 x 19mm	Clear Zinc	TX20	7,68-8,18	55WT19MC

Steel to steel (up to 3 or 4,4mm)



Size	Material/Finish	Head Ø	Art.Nr.
4,2 x 13mm	Clear Zinc	7,77-8,18	42OP13MC
4,2 x 16mm	Clear Zinc	7,77-8,18	42OP16MC
4,2 x 19mm	Clear Zinc	7,77-8,18	42OP19MC

Wood to heavy steel (up to 3mm)



Size	Material/Finish	Head Ø	Art.Nr.
4,2 x 35mm	Clear Zinc	8,00-8,50	42GS35MC
4,2 x 41mm	Clear Zinc	8,00-8,50	42GS41MC
4,2 x 65mm	Clear Zinc	8,00-8,50	42GS65MC

SCREW SYSTEM ACCESSORIES

Attachment DS50

SCREW FASTENING

ITEM 6W2001N



Features

- Easy load rail
- Patented sliding rail
- Tool free adjustable nose piece
- Patent pending corner-fit system
- Precise depth-of-drive adjustment with depth lock

Please note: The DS50 is an attachment and requires assembly to a screwdriver.

Attachment DS75

SCREW FASTENING

ITEM- 6W2003N



Features

- Easy load rail
- Patented sliding rail
- Tool free adjustable nose piece
- Patent pending corner-fit system
- Precise depth-of-drive adjustment with depth lock

Please note: The DS75 is an attachment and requires assembly to a screwdriver.

Attachment ExTPro

SCREW FASTENING

ITEM WB0061EU



Features

- Stand up application
- Effortlessly fastening of different floors
- Handle to use for fastening on ceilings
- Perfectly suitable to fasten trapeze shaped roofing plates
- Works with all DuraSpin tools

Adapters

For attaching screwdrivers to attachments			
Screwdriver	Fits Tools		Adapter ITEM #
DeWalt	DW252	DW266	ADP009
	DW253	DW272	
	DW255	DW276	
	DW257		
MAKITA	FS2200	FS4200	ADP019
	FS2500	FS6200	
	FS2701		MB0174
	6805BV	6827	ADP020
	6820	6824	ADP011
6821	6825		
6823	6826		
HITACHI	W6V4	W6VM	ADP010
	W6VA4	W8VB2	
	W6VB3		ADP017
	WH14DM		
SIoux	Screwdrivers with 1/4" internal hex feature		ADP018



Product Reference Chart

TOOL SPECS	DS50	DS75	ExTPro
Length	521 mm	521 mm	183 mm
Width	70 mm	70 mm	310 mm
Height	89 mm	89 mm	1185 mm
Weight	0,68 kg	1,6 kg	2,9 kg
Warranty	1 yr	1 yr	
FASTENER SPECS	Collated screws are located on pages ?-?		
Range	13*-55	25-75	
Shank Diameter	3,5-4,8	3,5-5,5	
APPLICATIONS	Metal framing, gypsum sheathing, structural steel decking, drywall to wood and steel, underlayment and flooring, sheathing to wood and steel	Metal framing, gypsum sheathing, rigid foam insulation, structural steel decking, drywall to wood and steel underlayment and flooring	Decking, subfloor, underlayment, mezzanine systems, modular floor, ceiling drywall

* 13-25 mm screws require special metal framing nosepiece FC0948EU

SCREW SYSTEM ACCESSORIES

Bits

Integrated auto-feed screw systems — 2 bits per pack			
Bits Fit		DS5525 DS5550	DS7525
	Art.Nr.	EA0326B	EA0329B
	Art.Nr.	EA0327B	EA0330B
	Art.Nr.	EA0335B	EA0337B*
	Art.Nr.	EA0336B	EA0338B*
	Art.Nr.	EA0333B	EA0334B

* article could have longer delivery time

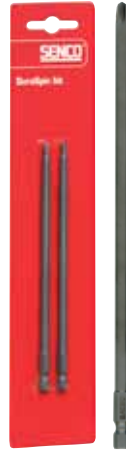

Nosepieces

For wood applications			
Fits Tools	Range	ITEM #	
DS5525 DS5550 DS50	25-55mm	FB0162EU	
DS7525 DS75	25-75mm	FB0160EU	

For drywall applications			
Fits Tools	Range	ITEM #	
DS5525 DS5550 DS50	25-55mm	FC0886EU	
DS7525 DS75	25-75mm	FC0906EU	

For metal framing applications			
Fits Tools	Range	ITEM #	
DS5525 DS5550 DS50	13-25mm	FC0948EU	

Bits

Screwdriver and attachment combinations — 2 bits per pack			
Bit Fit	ITEM #	ITEM #	ITEM #
Senco DS50			
ADP019	EA035TB	EA0364TB	EA0313B
MB0174	EA035TB	EA0364TB	EA0313B
ADP011	EA0369TB	EA0368TB	EA0319B
ADP020	EA0369TB	EA0368TB	EA0319B
Senco DS75			
ADP019	EA0363TB	EA0362TB	EA0316B
MB0174	EA0363TB	EA0362TB	EA0316B
ADP011	EA0367TB	EA0366TB	EA0322B
ADP020	EA0367TB	EA0366TB	EA0322B
AD0020	EA0367TB	EA0366TB	EA0322B

Battery Systems

Compatible with all 18V Li-Ion DuraSpin and SENCO FUSION tools		
18V Li-Ion Battery 1.5 amp hour	Fits	
VB0160EU	DS5525-18V DS5550-18V DS7525-18V All Fusion Models	 <ul style="list-style-type: none"> • 1.5 amp hour • High-quality reliable cells • Longer storage life • Charges 80% in 15 minutes
18V Li-Ion Battery 3.0 amp hour	Fits	
VB0162EU	DS5525-18V DS5550-18V DS7525-18V All Fusion Models	 <ul style="list-style-type: none"> • 3.0 amp hour • High-quality reliable cells • Longer storage life • Drives up to 2X as many fasteners as VB0155

Charger System

Can be used interchangeably with SENCO VB0155, VB0161 and VB0118 batteries		
Battery Charger	For use with	
EU plug: VB0157EU UK plug: VB0159EU	VB0160EU VB0162EU	 <ul style="list-style-type: none"> • Battery charge indicators display charge status of your battery • Compatible with all SENCO 18V Li-Ion batteries

SENCO tools: Solid as a rock!

In order to drive a nail into concrete you will need a powerful tool specifically designed for this purpose. By using a cordless concrete nail gun the user can navigate the job site with no restrictions and can save valuable time as no pre-drilling is needed.

Apart from using the right tool it is important to use the right nails for fastening in concrete. Fasteners for concrete applications are harder than a traditional nail and feature a special, tack design, to increase grip power.

APPLICATIONS

Installation of furring strips, plywood to concrete nailing, wire lath installation, ceiling grid to concrete, wood to metal, decking, fencing, subfloor to concrete slab.

FEATURES

- Rear-loading
- Adjustable depth of drive
- Quick and easy two-step fastener loading



BENEFITS

- Cordless convenience Consistent drives in all weather conditions
- 10 times faster than powder actuated systems



Tool accessories

Magnetic nose piece

Description	ITEM #	
Magnetic nose piece for SGP40S/SGP40L	HC0697	
Magnetic nose piece for SGP40/SAP40	HC0690	

Metal washer

Description	ITEM #	
Metal washer 25,4x1,1mm	SWM025B	

SAP40XP

CONCRETE NAILER

ITEM 5V9201N



0°

Features

- Well balanced, rugged design
- Magnesium body
- Uses up to 15% less air than competitor tools
- Functions with a "low pressure" compressor
- Includes case

Note: Only available in grey.

SGP40S

CONCRETE NAILER

ITEM 5H9211N, 5H9211N-L (LONG MAGAZINE), 5H9711N (UK)



0°

Features

- High voltage ignition
- Adjustable depth of drive
- Interchangeable short and long magazine
- Comfort grip
- Rear loading
- Includes case

CONCRETE/STEEL

0°

Concrete Nails Regular

Length	Point	Finish	Coating	Collation	Box Count	Item code
2.7x19mm	Pinched	Galv	Plain	Straight Plastic strip	1.000	SCP2719
2.7x22mm	Pinched	Galv	Plain	Straight Plastic strip	1.000	SCP2722
2.7x25mm	Pinched	Galv	Plain	Straight Plastic strip	1.000	SCP2725
2.7x32mm	Pinched	Galv	Plain	Straight Plastic strip	1.000	SCP2732
2.7x38mm	Pinched	Galv	Plain	Straight Plastic strip	1.000	SCP2738
3.1x15mm	Pinched	Galv	Plain	Straight Plastic strip	1.000	SCP3115

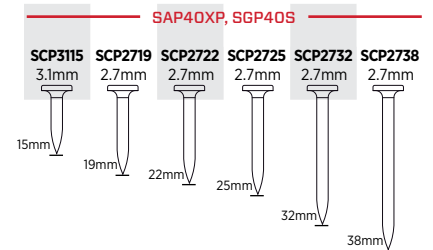

0°

Concrete Nails Premium

Length	Point	Finish	Coating	Collation	Box Count	Item code
3.0x15mm	Pinched	Galv	Plain	Straight Plastic strip	1.000	SCP3015P
3.0x19mm	Pinched	Galv	Plain	Straight Plastic strip	1.000	SCP3019P
3.0x22mm	Pinched	Galv	Plain	Straight Plastic strip	1.000	SCP3022P
3.0x25mm	Pinched	Galv	Plain	Straight Plastic strip	1.000	SCP3025P
3.0x32mm	Pinched	Galv	Plain	Straight Plastic strip	1.000	SCP3032P
3.0x38mm	Pinched	Galv	Plain	Straight Plastic strip	1.000	SCP3038P

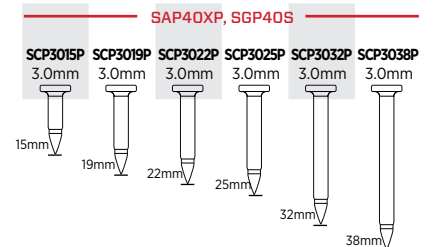

Product Reference Chart

TOOL SPECS	SAP40XP
Length	463 mm
Width	114 mm
Height	362 mm
Weight	3,2 kg
Actuation	BF(TF)
Air Inlet	3/8" NPT
Operating Pressure	5,5-8,3 bar
Air Consumption	147 l/min
Magazine capacity	42
Warranty	5 yrs
FASTENER SPECS	
Shank	2,7-3,1
Range	15-40mm
Angle/Collation	Straight Plastic strip
Series	SCP
APPLICATIONS	
	Nailing into concrete, masonry & steel

TOOL SPECS	SGP40S
Length	340 mm
Width	107 mm
Height	380 mm
Weight	4,0 kg
Actuation	TF
Battery	6V 1,5 Ah Ni-MH
Recharge time	2 hours
Fuel cell	40g (31,5x165 mm)
Magazine capacity	22
Warranty	2 yrs
FASTENER SPECS	
Shank	2,7-3,1
Range	15-40mm
Angle/Collation	Straight Plastic strip
Series	SCP
APPLICATIONS	
	Ceiling grid to concrete, fastening of drywall track

SENCO provides Smart Solutions!

With SENCO's innovative Smart Solutions the production process can be simplified and at the same time improved in terms of accuracy, speed and ergonomics. The solutions are used in combination with powerful SENCO XP hand tools.

Smart fastening with intelligent PLC

The Smart BoardMaster is equipped with a programmable PLC for short and long staple spacing including a quick change between the two. The spacing can be set freely from 30mm with increments of 5mm. A laser line for optical staple guiding ensures optimal positioning of the staples. With the telescopic arm great operating comfort is achieved. The Smart BoardMaster can be operated directly on the work surface and manoeuvred easily or run over a fixed track for straight line fastening.



SENCO High Load tools

SENCO High Load tools are a range of nailers and staplers with high load fastener capability to meet the highest demands of modern, automated timber framing technology. The High Load tools are designed for permanent installation on automated production lines for high volume manufacturing. Using SENCO High Load Tools enables a higher production, less refilling, less down time and more profit.

IN THE SPOTLIGHT

SENCO High Load tools

A high load modular tool range suitable for various fastener types to meet the demands of high speed automated production systems.



MAKING HARD WORK EASIER



Entry level automation

The Senco Smart Bridge has been developed for entry level automation of nailing, stapling and screwing of wood prefabricated panels.

The highly flexible Smart Bridge will help manufacturers increase capacity and quality without adding manpower with a return on investment within a year. The modular design of the Senco Smart Bridge makes it easy to install into any production line and will be up and running within hours. The Senco Smart Bridge provides practical fastening solutions for any manufacturer producing wall panels or flooring elements.



NAILS



SCREWS



STAPLES

Easy and consistent fixing

The Smart BoardFixer is the ideal tool to improve ergonomics in production environments with set distances, to shoot fasteners every 75mm or 150mm. The nailer or stapler can be positioned easily at any distance from the edge of the panel to drive fasteners at set increments in a line along the edge. The system eliminates the need to stretch over or climb onto the panel.



More information about our Smart Solutions are provided in a separate flyer

STAPLES

SENCO HAS YOU COVERED. SINCE 1948.

SENCO staples are available in several variations. Depending on the application customers can choose between fine wire, narrow crown, medium crown and wide crown staples and staplers. SENC0 offers a range of fine and medium wire staplers for upholstery and furniture assembly. Our upholstery staplers are the most customizable in the industry, with long nosepieces, extended magazines and a wide range of fasteners for any project.

APPLICATIONS

Upholstery, furniture assembly, cabinets, bedding, picture frames, molding, roof felt, house wrap, RV construction

FEATURES

Lightweight
Ergonomic
Variety of configurations



STAPLES

TOOLS

Pneumatic

XP Heavy duty

SFT10XP	22
SFT10XP-DL	22
SFT10XP-LN	22
SLS20XP	23
SLS25XP	23
SKSXP	23
SHS50XP	24
SHS51XP	24
SQS55XP	24
WC150XP	25
WC200XP	25

Heavy duty

SFW09	26
SLS18MG	26
SMS92	26
SNS41	27
WC330-SP	27
WC360-SP	27

Light duty

SFW05	28
S150LS	28
S150MS	28

FASTENERS

Fine Wire	29
Medium Wire	31
Heavy Wire	32
High Load	35

Choose the right staple

Light wire staples: furniture upholstery, light wood assembly, roof paper, insulation.

Medium crown staples: floor decking, roof sheathing, soft wall sheathing, subflooring, pallet construction, vinyl siding and insulation installation.

Wide crown staples: Insulation sheathing, wire lathing, housewrap, attaching corrugated to pallets, furniture and cabinet frame assembly.

COLLATED STAPLES BENEFITS

- Easy to use
- Versatile Time-saving
- Great variety of dimensions, material and coatings

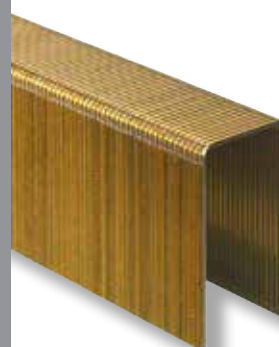

SFT10XP

LIGHT WIRE STAPLER

SEE ITEM # CHART

20_{GA} 21_{GA} 22_{GA}



Features

- One-handed magazine opening
- Rear exhaust
- Comfort grip
- Short trigger stroke

Models and Item Numbers				
Crown	Ga	Staple	Description	Item Code
4,8	22	A/D	TF	6S2001N
12,7	22	B	TF	6S2011N
12,7	22	B	Auto	6S2111N
9,5	22	C	TF	6S2021N
9,5	22	C	Auto	6S2121N
4,8	20	E	TF	6S2031N
12,7	20	F	TF	6S2041N
9,5	20	G	TF	6S2051N
12,7	21	AT	TF	6S2061N
12,7	21	AT	Auto	6S2161N

SFT10XP-DL

LIGHT WIRE STAPLER DOUBLE LENGTH MAGAZINE

SEE ITEM # CHART

20_{GA} 21_{GA} 22_{GA}



Features

- One-handed magazine opening
- Rear exhaust
- Comfort grip
- Short trigger stroke
- Double length magazine

Models and Item Numbers				
Crown	Ga	Staple	Description	Item Code
12,7	22	B	TF	6S2211N
9,5	22	C	TF	6S2221N
9,5	22	C	Auto	6S2321N
12,7	20	F	Auto	6S2341N
9,5	20	G	Auto	6S2351N
12,7	21	AT	Auto	6S2361N

SFT10XP-LN

LIGHT WIRE STAPLER LONG NOSE

SEE ITEM # CHART

21_{GA} 22_{GA}



Features

- One-handed magazine opening
- Rear exhaust
- Comfort grip
- Short trigger stroke
- For deep reach applications

Models and Item Numbers				
Crown	Ga	Staple	Description	Item Code
9,5	22	C	TF	6S2421N
12,7	21	AT	TF	6S2461N

Product Reference Chart

TOOL SPECS	SFT10XP	SFT10XP-DL	SFT10XP-LN
Length	218 mm	375mm	305mm
Width	42 mm	42 mm	51 mm
Height	167 mm	167 mm	218 mm
Weight	1,0 kg	1,0 kg	1,0 kg
Actuation	TF/Automatic	TF/Automatic	TF/Automatic
Air Inlet	¼" NPT	¼" NPT	¼" NPT
Operating Pressure	4,1-6,5 bar	4,1-6,5 bar	4,1-6,5 bar
Air Consumption	19,8 l/min	19,8 l/min	19,8 l/min
Magazine capacity	180	390	180
Warranty	5 yrs	5 yrs	5 yrs
FASTENER SPECS	Fasteners are located on pages 29-35		
Crown	4,8 9,5 12,7	9,5 12,7	9,5 12,7
Range	4-16mm	4-16mm	4-16mm
Angle/Collation	Straight Glued Strip	Straight Glued Strip	Straight Glued Strip
Series	A/D, AT, B, C, E, F, G	AT, B, C, F, G	AT, C
APPLICATIONS	Upholstering operations, furniture assembly, cabinets, interior trim, bedding manufacture, picture frames, molding and roofing felt	Upholstering operations, furniture assembly, cabinets, interior trim, bedding manufacture, picture frames, molding and roofing felt	Upholstering operations, furniture assembly, cabinets, interior trim, bedding manufacture, picture frames, molding and roofing felt



Stapling Upholstery for Over 70 Years

SENCO® offers 18 configurations of upholstery staplers and over 40 combinations of staple length, crown and gauge.

SLS20XP

MEDIUM WIRE STAPLER

SEE ITEM # CHART

18_{GA} 19_{GA}



Features

- Oil free
- Lightweight
- Ergonomic design
- No-Mar pad
- Depth adjustment
- Comfort Grip
- Includes case

Models and Item Numbers				
Crown	Ga	Staple	Description	Item Code
6,4	19	K	BF(TF)	492026N
6,4	18	L	BF(TF) + Case	492023N
9,5	18	M	BF(TF) + Case	492024N
9,5	18	M	BF/Auto	492009N
9,5	18	M	Sencomatic	490009N

SLS25XP

MEDIUM WIRE STAPLER

SEE ITEM # CHART

18_{GA}



Features

- Oil free
- Lightweight
- Ergonomic design
- Suitable for high volume production environments
- Depth adjustable

Models and Item Numbers				
Crown	Ga	Staple	Description	Item Code
6,4	18	L	BF(TF)	822009N
9,5	18	M	BF(TF)	822010N

SKSXP

MEDIUM WIRE STAPLER

SEE ITEM # CHART

16_{GA} 18_{GA}



Features

- Oil free
- Lightweight
- Low maintenance
- Only 2 moving O-rings
- Long 25mm lip to get into tight spots

Models and Item Numbers				
Crown	Ga	Staple	Description	Item Code
6,4	18	L	BF(TF)	302020N
6,4	18	L	TF	302028N
9,5	18	M	BF(TF)	302052N
9,5	18	M	TF	302060N
10,6	16	N	BF(TF)	302084N

Product Reference Chart

TOOL SPECS	SLS20XP	SLS25XP	SKSXP
Length	305 mm	305 mm	314 mm
Width	51 mm	51 mm	51 mm
Height	216 mm	229 mm	238 mm
Weight	1,1 kg	1,2 kg	1,9 kg
Actuation	BF(TF)	BF(TF)	BF(TF)
Air Inlet	¼" NPT	¼" NPT	¼" NPT
Operating Pressure	4,8-8,3 bar	4,8-8,3 bar	4,8-8,3 bar
Air Consumption	54 l/min	54 l/min	61 l/min
Magazine capacity	168	168	160
Warranty	5 yrs	5 yrs	5 yrs
FASTENER SPECS	Fasteners are located on pages 29-35		
Crown	6,4 9,5	6,4 9,5	6,4 9,5 10,6
Range	12-25mm	10-38mm	22-38mm
Angle/Collation	Straight Glued Strip	Straight Glued Strip	Straight Glued Strip
Series	K, L, M	L, M	L, M, N
APPLICATIONS	Furniture, cabinets, paneling, upholstery, siding, fencing	Furniture, cabinets, paneling, upholstery, siding, fencing	Furniture, cabinets, paneling, upholstery, sidings, doors & window casings

SHS50XP
HEAVY WIRE STAPLER
ITEM 7B2001N



- Features**
- 15% more powerful than all other construction staplers in its class
 - Adjustable depth of drive
 - Better balance
 - All metal magazine
 - 25mm lip length for access into tight corners

SHS51XP
HEAVY WIRE STAPLER
ITEM 7C2001N, XL3096 (AUT.)



- Features**
- 20% more powerful than the SHS50XP
 - Adjustable depth of drive
 - Better balance
 - All metal magazine
 - 25mm lip length for access into tight corners

SHS51XP
sencomatic



Special nose piece for Fermacell boards

Manual speed adjustment setting

Speed up to 12 shots per second



SQS55XP
HEAVY WIRE STAPLER
SEE ITEM # CHART



- Features**
- Rugged dependability
 - Adjustable exhaust
 - Adjustable depth of drive
 - Up to 15 shots per sec.
 - EZ-Clear Nose

Models and Item Numbers				
Crown	Ga	Staple	Description	Item Code
11,2	15	Q	BF(TF)	662001N
11,2	15	Q	TF	662002N
11,2	15	Q	Automatic	EJ00300
11,7	14	S	BF(TF)	XL3089
11,7	14	S	TF	XL3089R

Product Reference Chart

TOOL SPECS	SHS50XP	7C2001N SHS51XP XL3096	SQS55XP
Length	381 mm	387 mm	365 mm
Width	89 mm	89 mm	92 mm
Height	279 mm	293 mm	305 mm
Weight	2,3 kg	2,3 kg	2,7 kg
Actuation	BF(TF)	BF(TF)	BF(TF)
Operating Pressure	4,8-8,3 bar	4,8-8,3 bar	5,5-8,3 bar
Air Inlet	3/8" NPT	3/8" NPT	3/8" NPT
Air Consumption	90 l/min	90 l/min	185 l/min
Magazine capacity	160	160	130
Warranty	5 yrs	5 yrs	5 yrs
FASTENER SPECS	Fasteners are located on pages 29-35		
Crown	10,6 10,4	10,6 10,4	11,2 11,7
Range	25-50mm	25-50mm	38-63mm, 90mm
Angle/Collation	Straight Glued and Taped Strip	Straight Glued and Taped Strip	Straight Glued and Taped Strip
Series	N, O	N, O	Q, S
APPLICATIONS	Sheathing, furniture framing, subflooring, crate & box assembly, pallets, shingles	Sheathing, furniture framing, sub-flooring, crate & box assembly, pallets, shingles	Framework, subfloors, lathing, plate material, furniture hulls, pallets, crates, decking

WC150XP

WIDE CROWN STAPLER

ITEM 4W2001N



16^{GA}

Features

- Rugged design
- Lightweight
- Adjustable depth of drive
- Large staple capacity
- EZ-Clear Nose

Block out kit for short staples (P08-P11)
Pogostick

YK0786
VC0371

WC200XP

WIDE CROWN STAPLER

ITEM 4Y2001N



16^{GA}

Features

- Rugged design
- Lightweight
- Adjustable depth of drive
- Large Staple capacity
- EZ-Clear Nose

Pogostick

VC0371

The SHS51XP is the Benchmark Framing Stapler for the Furniture Industry.

- 20% more powerful than all other staplers in its class to handle the toughest engineered woods.
- Drives both 16 and 17 gauge, 11.1mm crown staples (25-50mm in length).
- The combination of class-leading power, durability and ergonomics make it an unrivaled professional tool.



Product Reference Chart

TOOL SPECS	WC150XP	WC200XP
Length	387 mm	387 mm
Width	89 mm	89 mm
Height	225 mm	254 mm
Weight	2,3 kg	2,4 kg
Actuation	BF(TF)	BF(TF)
Operating Pressure	4,8-8,3 bar	4,8-8,3 bar
Air Inlet	3/8" NPT	3/8" NPT
Air Consumption	90 l/min	97 l/min
Magazine capacity	160	160
Warranty	5 yrs	5 yrs
FASTENER SPECS	Fasteners are located on pages 29-35	
Crown	25,4	25,4
Range	16-38mm	22-50mm
Angle/Collation	Straight Glued and Taped Strip	Straight Glued and Taped Strip
Series	P	P
APPLICATIONS	Lathing, roof and wall felt, furniture, frames, cardboard onto pallets, packaging, insulation board, butt joints	Lathing, roof and wall felt, furniture, frames, cardboard onto pallets, packaging, insulation board, butt joints

SFW09

LIGHT WIRE STAPLER

SEE ITEM # CHART

20_{GA} 21_{GA} 22_{GA}



Features

- Long 25mm lip
- Rounded steel cap
- Rear exhaust
- Rear magazine bumper
- Comfort grip

Models and Item Numbers

Crown	Ga	Staple	Description	Item Code
12,7	21	AT	TF	4C2021N
9,5	22	C	TF	4C2001N
12,7	20	F	TF	4C2041N

SLS18Mg

MEDIUM WIRE STAPLER

SEE ITEM # CHART

18_{GA}



Features

- Magnesium body
- Oil free
- Adjustable depth of drive
- Selectable trigger
- Comfort grip
- Includes case

Models and Item Numbers

Crown	Ga	Staple	Description	Item Code
6,4	18	L	BF(TF)	1W2025N
9,5	18	M	BF(TF)	1W2026N

SMS92

MEDIUM WIRE STAPLER

SEE ITEM # CHART

18_{GA}



Features

- Magnesium body
- Special developed guiding mechanism
- 360° adjustable exhaust
- Selectable trigger
- Quick release mechanism

Models and Item Numbers

Crown	Ga	Staple	Description	Item Code
8,5	18	92	BF(TF)	1VS2003N

Product Reference Chart

TOOL SPECS	SFW09	SLS18MG	SMS92
Length	241 mm	260 mm	310 mm
Width	49 mm	64 mm	78 mm
Height	151 mm	241 mm	274 mm
Weight	0,9 kg	1,2 kg	1,9 kg
Actuation	TF	BF(TF)	BF(TF)
Air Inlet	¼" NPT	¼" NPT	¼" NPT
Operating Pressure	4,1-6,5 bar	4,8-8,3 bar	4,8-8,3 bar
Air Consumption	23 l/min	68 l/min	55 l/min
Magazine capacity	110-185	110	160
Warranty	1 yr	1 yr	1 yr
FASTENER SPECS	Fasteners are located on pages 29-35		
Crown	9,5 12,7	6,4 9,5	8,5
Range	6-16mm	10-38mm	18-40mm
Angle/Collation	Straight Glued Strip	Straight Glued Strip	Straight Glued Strip
Series	AT, C, F	L, M	92
APPLICATIONS	Upholstering operations, furniture assembly, cabinets, automotive vinyl roofs and interior trim, bedding manufacture, picture frames, shoemaking, molding, roofing felt	Cabinets, furniture, drawer assembly, case backs, picture frames	Furniture frames, cabinets

SNS41

HEAVY WIRE STAPLER

ITEM 3L2003N (BF(TF)), 3L2004N (TF)



16^{GA}

17^{GA}

Features

- Durable design
- Adjustable depth of drive
- 360° adjustable exhaust
- EZ-Clear Nose
- Comfort grip
- Reload indicator

WC360-SP

WIDE CROWN STAPLER

ITEM 7E2001N



14^{GA}

Features

- Ergonomic design
- Adjustable depth of drive
- Available with extra handle for higher user convenience

WC330-SP

WIDE CROWN STAPLER

ITEM 6P2001N



14^{GA}

Features

- Ergonomic design
- Adjustable depth of drive
- Available with extra handle for higher user convenience

Product Reference Chart

TOOL SPECS	SNS41	WC330-SP	WC360-SP
Length	381 mm	397 mm	400 mm
Width	75 mm	133 mm	138 mm
Height	273 mm	400 mm	470 mm
Weight	2,1 kg	5,9 kg	6,3 kg
Actuation	BF(TF)	TF	TF
Air Inlet	3/8" NPT	3/8" NPT	3/8" NPT
Operating Pressure	5,5-8,3 bar	5,5-8,3 bar	5,5-8,3 bar
Air Consumption	153 l/min	176 l/min	261 l/min
Magazine capacity	160	120	160
Warranty	1 yr	1 yr	1 yr
FASTENER SPECS	Fasteners are located on pages 29-35		
Crown	10,6 10,4	27,0	27,0
Range	25-50mm	65-130mm	90-160mm
Angle/Collation	Straight Glued Strip	Straight Glued Strip	Straight Glued Strip
Series	N, O	SP	SP
APPLICATIONS	Framework, sub-floors, sheathing, furniture framing, pallets, ramps and gates, crates, fascia & soffits	To fasten (thermowall) insulating materials. Planking wooden outside frames with wood fibre board and wood wool sandwich board.	To fasten (thermowall) insulating materials. Planking wooden outside frames with wood fibre board and wood wool sandwich board.

SFW05

LIGHT WIRE STAPLER

ITEM SFW05-B, SFW05-C, SFW05-AT

21_{GA} 22_{GA}**Features**

- Slim, compact design for use in small spaces
- Adjustable exhaust
- Lightweight

S150MS

MEDIUM WIRE STAPLER

ITEM 1VS2005N

18_{GA}**Features**

- Adjustable depth of drive
- Comfort grip
- Reload indicator

S150LS

MEDIUM WIRE STAPLER

ITEM 952008N

18_{GA}**Features**

- Adjustable depth of drive
- Comfort grip
- Reload indicator
- Includes case

Product Reference Chart

TOOL SPECS	SFW05	S150LS	S150MS
Length	229 mm	249 mm	249 mm
Width	45 mm	45 mm	45 mm
Height	163 mm	227 mm	227 mm
Weight	0,9 kg	1,5 kg	1,5 kg
Actuation	TF	TF	TF
Air Inlet	¼" NPT	¼" NPT	¼" NPT
Operating Pressure	5,2-6,9 bar	4,8-8,3 bar	4,8-8,3 bar
Air Consumption	27 l/min	54 l/min	54 l/min
Magazine capacity	100	100-110	100-110
Warranty	1 yr	1 yr	1 yr
FASTENER SPECS	Fasteners are located on pages 29-35		
Crown	9,5 12,7	6,4	9,5
Range	3-16mm	10-38mm	10-38mm
Angle/Collation	Straight Glued Strip	Straight Glued Strip	Straight Glued Strip
Series	AT, B, C	L	M
APPLICATIONS	Upholstering operations, furniture assembly, cabinets, automotive vinyl roofs and interior trim, bedding manufacture, TV and stereo grille cloth, picture frames, shoemaking, molding and roofing felt	Cabinets, furniture, drawer assembly, case backs, picture frames	Cabinets, furniture, drawer assembly, case backs, picture frames

STAPLES

FINE WIRE

22^{GA} A-staples

Length	Point	Finish	Coating	Collation	Box Count	Item code
4mm	Chisel	Galv	plain	Straight Glued Strip	60000	A02BAAP
6mm	Chisel	Galv	plain	Straight Glued Strip	60000	A04BAAP
8mm	Chisel	Galv	plain	Straight Glued Strip	40000	A05BAAP
10mm	Chisel	Galv	plain	Straight Glued Strip	40000	A06BAAP
12mm	Chisel	Galv	plain	Straight Glued Strip	30000	A08BAAP
14mm	Chisel	Galv	plain	Straight Glued Strip	26000	A09BAAP
16mm	Chisel	Galv	plain	Straight Glued Strip	22000	A10BAAP

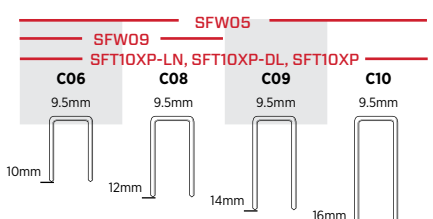
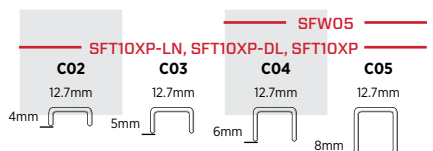
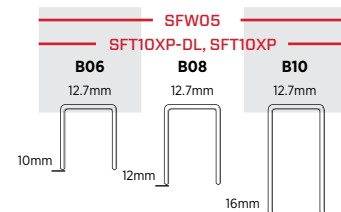
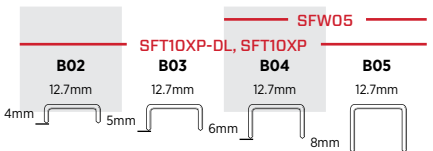
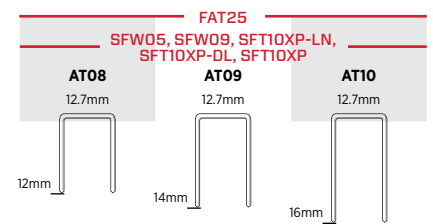
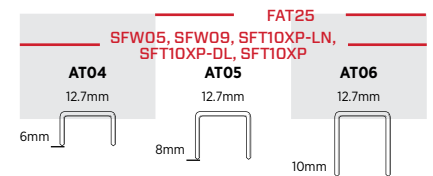
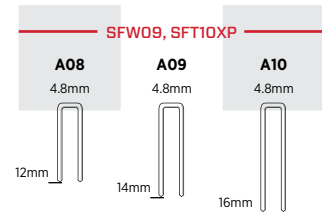
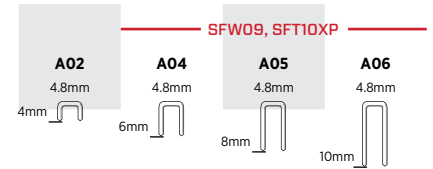

21^{GA} AT-staples

Length	Point	Finish	Coating	Collation	Box Count	Item code
6mm	Chisel	Galv	plain	Straight Glued Strip	24000	AT04BAAP
8mm	Chisel	Galv	plain	Straight Glued Strip	20000	AT05BAAP
10mm	Chisel	Galv	plain	Straight Glued Strip	16000	AT06BAAP
12mm	Chisel	Galv	plain	Straight Glued Strip	21000	AT08BAAP
14mm	Chisel	Galv	plain	Straight Glued Strip	18000	AT09BAAP
16mm	Chisel	Galv	plain	Straight Glued Strip	15000	AT10BAAP
10mm	Chisel	Stainless 304	plain	Straight Glued Strip	10000	AT06BGA

22^{GA} B-staples

Length	Point	Finish	Coating	Collation	Box Count	Item code
4mm	Chisel	Galv	plain	Straight Glued Strip	40000	B02BAAP
5mm	Chisel	Galv	plain	Straight Glued Strip	35000	B03BAAP
6mm	Chisel	Galv	plain	Straight Glued Strip	25000	B04BAAP
8mm	Chisel	Galv	plain	Straight Glued Strip	45000	B05BAAP
10mm	Chisel	Galv	plain	Straight Glued Strip	40000	B06BAAP
12mm	Chisel	Galv	plain	Straight Glued Strip	25000	B08BAAP
16mm	Chisel	Galv	plain	Straight Glued Strip	22000	B10BAAP

22^{GA} C-staples

Length	Point	Finish	Coating	Collation	Box Count	Item code
4mm	Chisel	Galv	plain	Straight Glued Strip	60000	C02BAAP
5mm	Chisel	Galv	plain	Straight Glued Strip	55000	C03BAAP
6mm	Chisel	Galv	plain	Straight Glued Strip	35000	C04BAAP
8mm	Chisel	Galv	plain	Straight Glued Strip	28000	C05BAAP
10mm	Chisel	Galv	plain	Straight Glued Strip	50000	C06BAAP
12mm	Chisel	Galv	plain	Straight Glued Strip	35000	C08BAAP
14mm	Chisel	Galv	plain	Straight Glued Strip	32000	C09BAAP
16mm	Chisel	Galv	plain	Straight Glued Strip	27000	C10BAAP
5mm	Chisel	Stainless 304	plain	Straight Glued Strip	55000	C03BGAP
6mm	Chisel	Stainless 304	plain	Straight Glued Strip	35000	C04BGAP
8mm	Chisel	Stainless 304	plain	Straight Glued Strip	28000	C05BGAP
10mm	Chisel	Stainless 304	plain	Straight Glued Strip	25000	C06BGAP
12mm	Chisel	Stainless 304	plain	Straight Glued Strip	17500	C08BGAP
16mm	Chisel	Stainless 304	plain	Straight Glued Strip	13500	C10BGAP

FINE WIRE

20_{GA} E-staples

Length	Point	Finish	Coating	Collation	Box Count	Item code
6mm	Chisel	Galv	plain	Straight Glued Strip	34000	E04BAAP
8mm	Chisel	Galv	plain	Straight Glued Strip	28000	E05BAAP
10mm	Chisel	Galv	plain	Straight Glued Strip	22000	E06BAAP
12mm	Chisel	Galv	plain	Straight Glued Strip	19000	E08BAAP
16mm	Chisel	Galv	plain	Straight Glued Strip	15000	E10BAAP

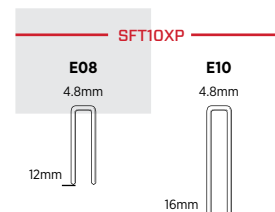
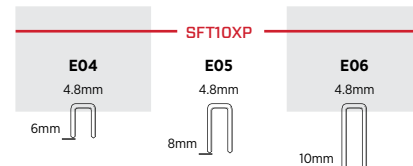

20_{GA} F-staples

Length	Point	Finish	Coating	Collation	Box Count	Item code
6mm	Chisel	Galv	plain	Straight Glued Strip	34000	F04BAAP
8mm	Chisel	Galv	plain	Straight Glued Strip	30000	F05BAAP
10mm	Chisel	Galv	plain	Straight Glued Strip	24000	F06BAAP
12mm	Chisel	Galv	plain	Straight Glued Strip	14000	F08BAAP
16mm	Chisel	Galv	plain	Straight Glued Strip	12000	F10BAAP
8mm	Chisel	Stainless 304	plain	Straight Glued Strip	15000	F05BGAP
10mm	Chisel	Stainless 304	plain	Straight Glued Strip	12000	F06BGAP
12mm	Chisel	Stainless 304	plain	Straight Glued Strip	7000	F08BGAP

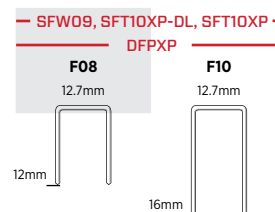
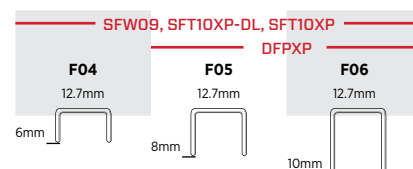

20_{GA} G-staples

Length	Point	Finish	Coating	Collation	Box Count	Item code
8mm	Chisel	Galv	plain	Straight Glued Strip	20000	G05BAAP
10mm	Chisel	Galv	plain	Straight Glued Strip	30000	G06BAAP
12mm	Chisel	Galv	plain	Straight Glued Strip	22000	G08BAAP
16mm	Chisel	Galv	plain	Straight Glued Strip	18000	G10BAAP

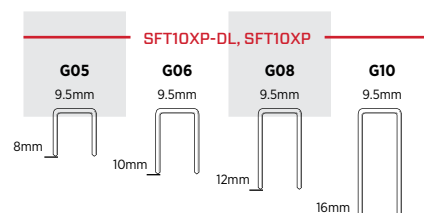

20_{GA} H-staple

Length	Point	Finish	Coating	Collation	Box Count	Item code
10mm	Chisel	Galv	plain	Straight Glued Strip	5000	H06BAA

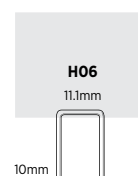

20_{GA} J-staples

Length	Point	Finish	Coating	Collation	Box Count	Item code
10mm	Chisel	Galv	plain	Straight Glued Strip	16000	J06BAAP
12mm	Chisel	Galv	plain	Straight Glued Strip	10000	J08BAAP
16mm	Chisel	Galv	plain	Straight Glued Strip	8000	J10BAAP

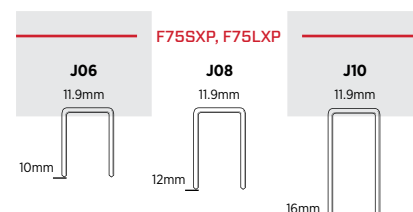

STAPLES

MEDIUM WIRE

19^{GA}

K-staples

Length	Point	Finish	Coating	Collation	Box Count	Item code
12mm	Chisel	Galv	Plain	Glued	16.000	K08BAAP
16mm	Chisel	Galv	Plain	Glued	14.000	K10BAAP
19mm	Chisel	Galv	Plain	Glued	10.000	K11BAAP
22mm	Chisel	Galv	Plain	Glued	9.000	K12BAAP
25mm	Chisel	Galv	Plain	Glued	8.000	K13BAAP

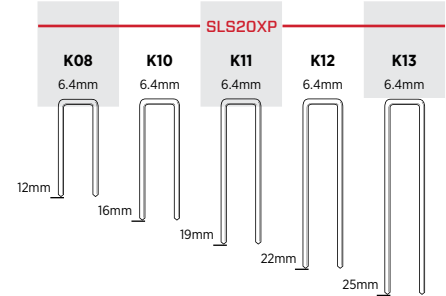

18^{GA}

92-Staples

Length	Point	Finish	Coating	Collation	Box Count	Item code
18mm	Chisel	Galv	Sencote	Glued	5.000	9218BAB
21mm	Chisel	Galv	Sencote	Glued	5.000	9221BAB
25mm	Chisel	Galv	Sencote	Glued	5.000	9225BAB
35mm	Chisel	Galv	Sencote	Glued	5.000	9235BAB
40mm	Chisel	Galv	Sencote	Glued	5.000	9240BAB

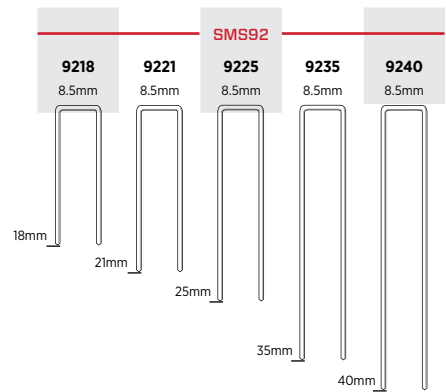

18^{GA}

L-staples

Length	Point	Finish	Coating	Collation	Box Count	Item code
12mm	Chisel	Galv	Sencote	Glued	10.000	L08BAB
16mm	Chisel	Galv	Sencote	Glued	5.000	L10BAB
19mm	Chisel	Galv	Sencote	Glued	5.000	L11BAB
22mm	Chisel	Galv	Sencote	Glued	5.000	L12BAB
25mm	Chisel	Galv	Sencote	Glued	5.000	L13BAB
28mm	Chisel	Galv	Sencote	Glued	5.000	L14BAB
32mm	Chisel	Galv	Sencote	Glued	5.000	L15BAB
35mm	Chisel	Galv	Sencote	Glued	5.000	L16BAB
38mm	Chisel	Galv	Sencote	Glued	5.000	L17BAB
12mm	Chisel	Stainless 304	Plain	Glued	10.000	L08BGA
16mm	Chisel	Stainless 304	Plain	Glued	5.000	L10BGA
19mm	Chisel	Stainless 304	Plain	Glued	5.000	L11BGA
25mm	Chisel	Stainless 304	Plain	Glued	5.000	L13BGA
32mm	Chisel	Stainless 304	Plain	Glued	5.000	L15BGA
38mm	Chisel	Stainless 304	Plain	Glued	5.000	L17BGA

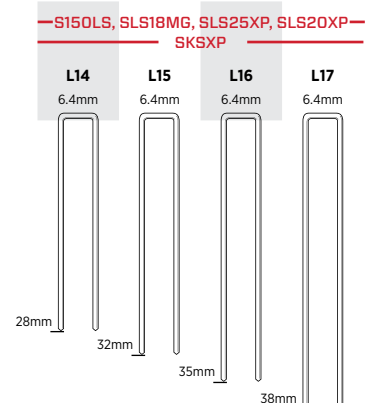
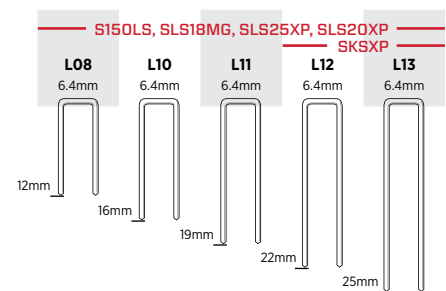

MEDIUM WIRE

18_{GA}

M-staples

Length	Point	Finish	Coating	Collation	Box Count	Item code
12mm	Chisel	Galv	Sencote	Glued	5.000	M08BAB
16mm	Chisel	Galv	Sencote	Glued	5.000	M10BAB
19mm	Chisel	Galv	Sencote	Glued	5.000	M11BAB
22mm	Chisel	Galv	Sencote	Glued	5.000	M12BAB
25mm	Chisel	Galv	Sencote	Glued	5.000	M13BAB
28mm	Chisel	Galv	Sencote	Glued	5.500	M14BAB
32mm	Chisel	Galv	Sencote	Glued	10.000	M15BAB
38mm	Chisel	Galv	Sencote	Glued	10.000	M17BAB
38mm	Chisel	Stainless 304	Plain	Glued	10.000	M17BGB

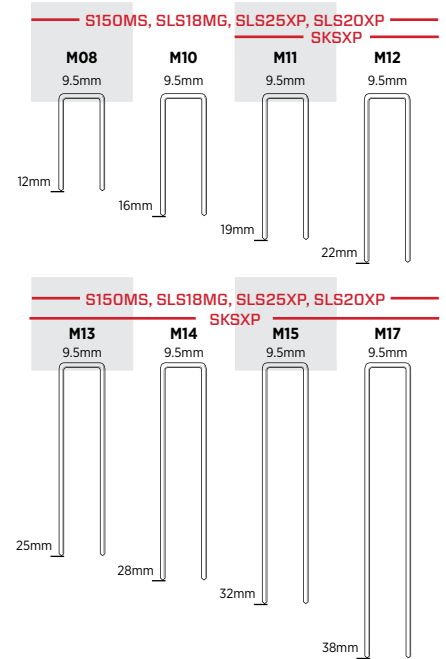

HEAVY WIRE

16_{GA}

N-staple

Length	Point	Finish	Coating	Collation	Box Count	Item code
19mm	Chisel	Plain	Sencote	Glued	20.000	N11BRBB
22mm	Chisel	Plain	Sencote	Glued	20.000	N12BRBB
25mm	Chisel	Plain	Sencote	Glued	20.000	N13BRBB
28mm	Chisel	Plain	Sencote	Glued	10.000	N14BRBB
32mm	Chisel	Plain	Sencote	Glued	10.000	N15BRBB
35mm	Chisel	Plain	Sencote	Glued	10.000	N16BRBB
38mm	Chisel	Plain	Sencote	Glued	10.000	N17BRBB
44mm	Chisel	Plain	Sencote	Glued	10.000	N19BRBB
50mm	Chisel	Plain	Sencote	Glued	10.000	N21BRBB
63mm	Chisel	Plain	Sencote	Glued	6.500	N25BRBB
19mm	Chisel	Galv	Sencote	Glued	20.000	N11BABB
22mm	Chisel	Galv	Sencote	Glued	20.000	N12BABB
25mm	Chisel	Galv	Sencote	Glued	20.000	N13BABB
28mm	Chisel	Galv	Sencote	Glued	10.000	N14BABB
32mm	Chisel	Galv	Sencote	Glued	10.000	N15BABB
35mm	Chisel	Galv	Sencote	Glued	10.000	N16BABB
38mm	Chisel	Galv	Sencote	Glued	10.000	N17BABB
44mm	Chisel	Galv	Sencote	Glued	10.000	N19BABB
50mm	Chisel	Galv	Sencote	Glued	10.000	N21BABB
63mm	Chisel	Galv	Sencote	Glued	6.500	N25BABB
38mm	Chisel	Galv 12mu	Sencote	Glued	10.000	N17BXBB
44mm	Chisel	Galv 12mu	Sencote	Glued	10.000	N19BXBB
50mm	Chisel	Galv 12mu	Sencote	Glued	10.000	N21BXBB
56mm	Chisel	Galv 12mu	Sencote	Glued	6.500	N23BXBB
63mm	Chisel	Galv 12mu	Sencote	Glued	6.500	N25BXBB
16mm	Diverg	Galv	Sencote	Glued	10.000	N10LAB
19mm	Diverg	Galv	Sencote	Glued	10.000	N11LAB
22mm	Diverg	Galv	Sencote	Glued	10.000	N12LAB
28mm	Diverg	Galv	Sencote	Glued	10.000	N14LAB
38mm	Chisel	Stainless 304	Plain	Glued	10.000	N17BGA

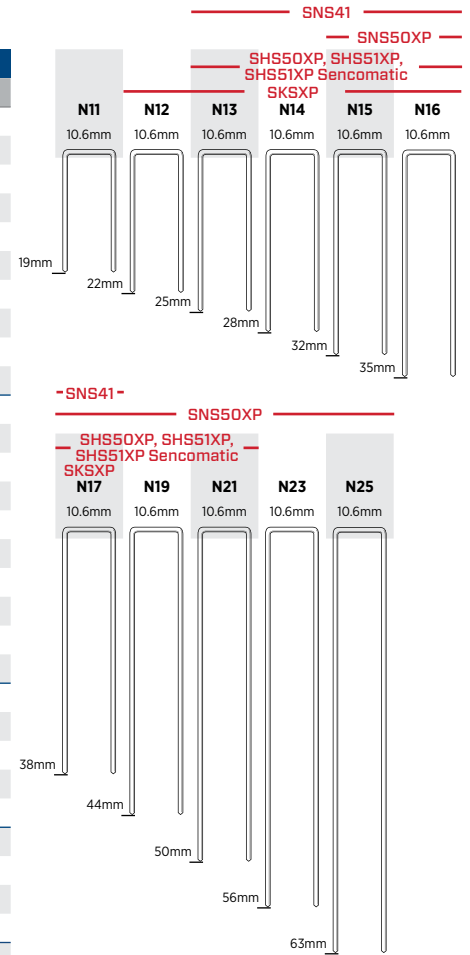

STAPLES

17_{GA}

O-staple

Length	Point	Finish	Coating	Collation	Box Count	Item code
32mm	Chisel	Plain	Sencote	Glued	10.000	O15BRBB
35mm	Chisel	Plain	Sencote	Glued	10.000	O16BRBB
38mm	Chisel	Plain	Sencote	Glued	10.000	O17BRBB
41mm	Chisel	Plain	Sencote	Glued	10.000	O18BRBB
44mm	Chisel	Plain	Sencote	Glued	10.000	O19BRBB
25mm	Chisel	Galv	Sencote	Glued	10.000	O13BABB
32mm	Chisel	Galv	Sencote	Glued	10.000	O15BABB
35mm	Chisel	Galv	Sencote	Glued	10.000	O16BABB
38mm	Chisel	Galv	Sencote	Glued	10.000	O17BABB
44mm	Chisel	Galv	Sencote	Glued	10.000	O19BABB

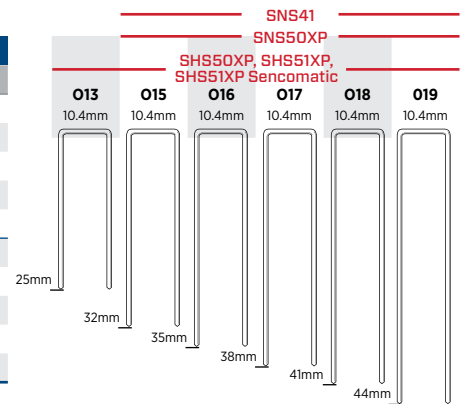

15_{GA}

Q-staple

Length	Point	Finish	Coating	Collation	Box Count	Item code
38mm	Chisel	Plain	Sencote	Glued	5.000	Q17BRBB
44mm	Chisel	Plain	Sencote	Glued	5.000	Q19BRBB
50mm	Chisel	Plain	Sencote	Glued	5.000	Q21BRBB
63mm	Chisel	Plain	Sencote	Glued	5.000	Q25BRBB
38mm	Chisel	Galv	Sencote	Glued	5.000	Q17BABB
44mm	Chisel	Galv	Sencote	Glued	5.000	Q19BABB
50mm	Chisel	Galv	Sencote	Glued	5.000	Q21BABB
56mm	Chisel	Galv	Sencote	Glued	5.000	Q23BABB
63mm	Chisel	Galv	Sencote	Glued	5.000	Q25BABB
38mm	Chisel	Galv 12mu	Sencote	Glued	5.000	Q17BXBB
44mm	Chisel	Galv 12mu	Sencote	Glued	5.000	Q19BXBB
50mm	Chisel	Galv 12mu	Sencote	Glued	5.000	Q21BXBB
56mm	Chisel	Galv 12mu	Sencote	Glued	5.000	Q23BXBB
63mm	Chisel	Galv 12mu	Sencote	Glued	5.000	Q25BXBB
50mm	Chisel	Stainless 304	Plain	Glued	5.000	Q21BGBDIN
63mm	Chisel	Stainless 305	Plain	Glued	2.500	Q25BGBDIN

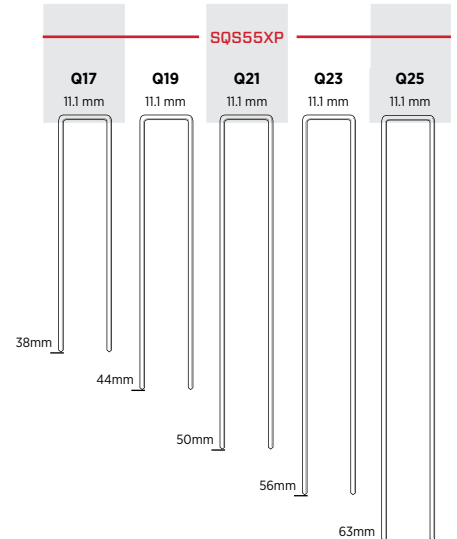

14_{GA}

S-staple

Length	Point	Finish	Coating	Collation	Box Count	Item code
44mm	Sp Chisel	Galv 12mu	Sencote	Strong Glue	6.500	S19NXBS
80mm	Chisel	Galv 12mu	Sencote	Glued	2.500	S28BXB
90mm	Chisel	Galv 12mu	Sencote	Glued	2.500	S29BXB

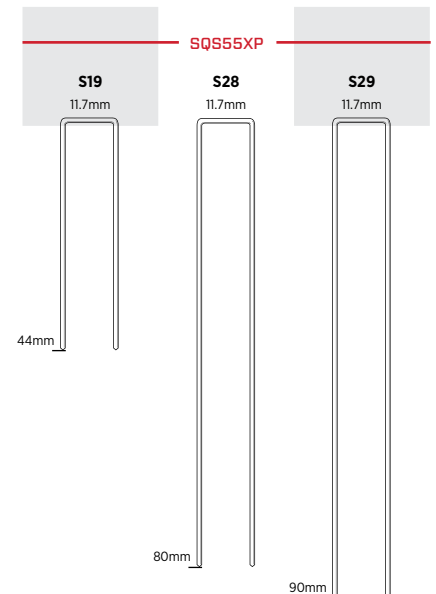

HEAVY WIRE

16_{GA}

P-staple

Length	Point	Finish	Coating	Collation	Box Count	Item code
12mm	Chisel	Galv	Sencote	Glued	10.000	P08BABB
16mm	Chisel	Galv	Sencote	Glued	10.000	P10BABB
19mm	Chisel	Galv	Sencote	Glued	10.000	P11BABB
22mm	Chisel	Galv	Sencote	Glued	10.000	P12BABB
25mm	Chisel	Galv	Sencote	Glued	10.000	P13BABB
32mm	Chisel	Galv	Sencote	Glued	5.000	P15BABB
38mm	Chisel	Galv	Sencote	Glued	5.000	P17BABB
44mm	Chisel	Galv	Sencote	Glued	5.000	P19BABB
50mm	Chisel	Galv	Sencote	Glued	5.000	P21BABB
16mm	Chisel	alu	Plain	Glued	10.000	P10BMA

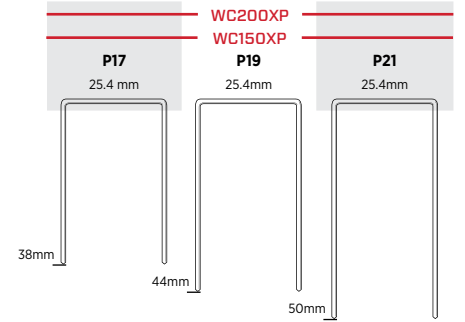
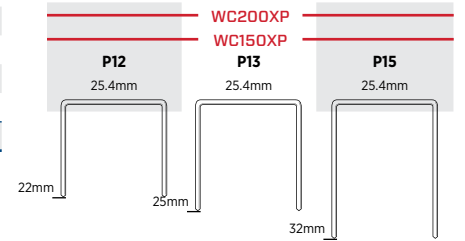
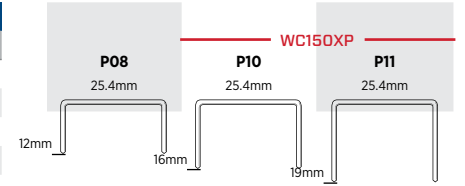

14_{GA}

SP-staple

Length	Point	Finish	Coating	Collation	Box Count	Item code
76mm	Sp Chisel	Galv 12mu	Sencote	Glued	1.000	SP27NXB
100mm	Sp Chisel	Galv 12mu	Sencote	Glued	1.000	SP30NXB
110mm	Sp Chisel	Galv 12mu	Sencote	Glued	1.000	SP36NXB
130mm	Sp Chisel	Galv 12mu	Sencote	Glued	1.000	SP45NXB
160mm	Sp Chisel	Galv	Sencote	Glued	1.000	SP56NAB
76mm	Sp Chisel	Stainless 304	Sencote	Glued	1.000	SP27NGB
100mm	Sp Chisel	Stainless 304	Sencote	Glued	1.000	SP30NGB
110mm	Sp Chisel	Stainless 304	Sencote	Glued	1.000	SP36NGB
130mm	Sp Chisel	Stainless 304	Sencote	Glued	1.000	SP45NGB
160mm	Sp Chisel	Stainless 304	Sencote	Glued	1.000	SP56NGB

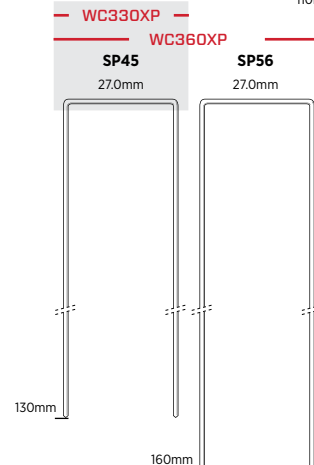
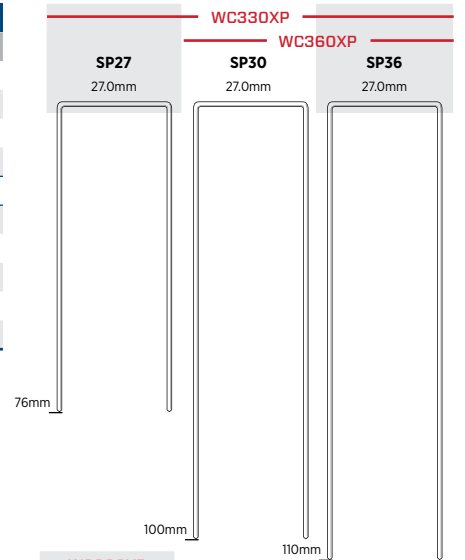

STAPLES

HIGH LOAD STAPLES

16_{GA}

High Load N-staple

Length	Point	Finish	Coating	Collation	Box Count	Item code
22mm	Chisel	Galv 12mu	Sencote	Strong Adhesive	20.000	N12BxBBHL
44mm	Chisel	Galv 12mu	Sencote	Strong Adhesive	10.000	N19BxBBHL
50mm	Chisel	Galv 12mu	Sencote	Strong Adhesive	10.000	N21BxBBHL
63mm	Chisel	Galv 12mu	Sencote	Strong Adhesive	6.500	N25BxBBHL
50mm	Chisel	Galv 12mu	Sencote	Strong Adhesive	10.000	N21BxBBHL-EU

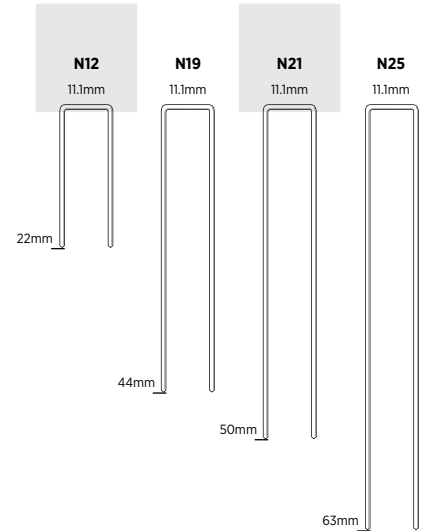

15_{GA}

High Load Q-staple

Length	Point	Finish	Coating	Collation	Box Count	Item code
44mm	Chisel	Galv 12mu	Sencote	Strong Adhesive	5.000	Q19BxBBHL
50mm	Chisel	Galv 12mu	Sencote	Strong Adhesive	5.000	Q21BxBBHL
56mm	Chisel	Galv 12mu	Sencote	Strong Adhesive	5.000	Q23BxBBHL
63mm	Chisel	Galv 12mu	Sencote	Strong Adhesive	5.000	Q25BxBBHL

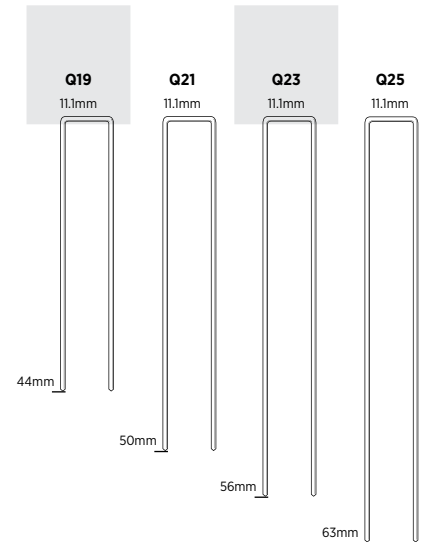

14_{GA}

High Load SP-staple

Length	Point	Finish	Coating	Collation	Box Count	Item code
75 mm	Chisel	Stainless 304	Sencote	Strong Adhesive	1.000	SP27NGBHL
100mm	Chisel	Stainless 304	Sencote	Strong Adhesive	1.000	SP30NGBHL
110mm	Chisel	Stainless 304	Sencote	Strong Adhesive	1.000	SP36NGBHL
130mm	Chisel	Stainless 304	Sencote	Strong Adhesive	1.000	SP45NGBHL
160mm	Chisel	Stainless 304	Sencote	Strong Adhesive	1.000	SP56NGBHL

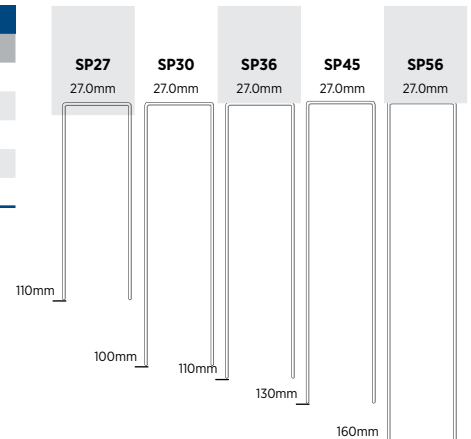

STRIPNAILS, BRADS AND PINS

NAILING THE RIGHT BALANCE OF SIZE, WEIGHT AND POWER

We offer a wide selection of strip and coil framing and sheathing nailers.

- Compact to maneuver around wall studs and floor joists easily
- Lightweight and ergonomic to reduce fatigue
- Built tough and powerful enough to drive fasteners into the most demanding materials

APPLICATIONS

Framing, sheathing, truss building, installing subflooring, decking or fencing, assembling boxes or making pallets

FEATURES

- Low profile designs allow for easy access between studs and joists
- Highly efficient internal design for increased durability and less wear and tear on the compressor
- Dry fire lock out prevents dry firing and signals user when to reload
- Claw-like safety for precise toe-nailing



STRIPNAILS

TOOLS

Pneumatic First Fix CH nailer/FRH nailer **XP Heavy duty**

SN90CXP	38
SN90FXP	38

Heavy duty

FramePro601	39
FramePro651	39
SidingPro40	39
MC60-34	40
SN1302	40
SN1602	40

Light duty

S900FN	41
--------	----

Pneumatic Second Fix Finish nailer **XP Heavy duty**

FinishPro*23SXP	43
FinishPro*23LXP	43
FinishPro*21LXP	43
SLP20XP	44
SLP20XP GLN	44
SBN10XP	44
LS1XP	44
FinishPro25XP	45
FinishPro30XP	45
FinishPro42XP	45

Heavy duty

FinishPro10	46
FinishPro18Mg	46
FinishPro32	46
FinishPro35Mg	46

Light duty

S200BN	47
S200SN	47
S250FN	47

Cordless First Fix CH nailer/FRH nailer

GT90CH	48
GT90FHA	48
GT35HN	48
GT60NN	48

Cordless Second Fix Finish nailer

GT50AX	49
GT65RHA	49
GT65RHS	49
GT65DA	49

FASTENERS

First Fix Nails	
Clipped Head Nails	50
Full Round Head Nails	52
First Fix Nails	
Pins	53
Brads	53
Finish Nails	53

ACCESSORIES

Gas tool maintenance	56
Gas tool batteries	56
Fuel cells	56
Fusion batteries	56

SN90CXP
CLIPPED HEAD NAILER
ITEM 2H2001N



34°

Features

- Fixed firing valve improves tool life and speed
- Overmold grip and trigger
- 360° adjustable exhaust
- Aggressive sawtooth safety
- Selectable trigger
- Includes case

SN90FXP
FULL ROUND HEAD NAILER
ITEM 2K2001N



20°

Features

- 20° in-line magazine provides excellent maneuverability and line of sight
- Simple two-step loading
- Aggressive toenail safety
- Fits easily between studs and joists

Product Reference Chart

TOOL SPECS	SN90CXP	SN90FXP
Length	384 mm	508 mm
Width	106 mm	106 mm
Height	337 mm	337 mm
Weight	3,6 kg	3,8 kg
Actuation	BF(TF)	BF(TF)
Air Inlet	3/8" NPT	3/8" NPT
Operating Pressure	4,8-8,3 bar	4,8-8,3 bar
Air Consumption	283 l/min	283 l/min
Magazine capacity	70	60
Warranty	5 yrs	5 yrs
FASTENER SPECS	Fasteners are located on pages 50-55	
Shank	2,9-3,3	2,9-3,8
Range	50-90mm	50-90mm
Angle/Collation	34° Angled Tape Strip	20° Angled Plastic collated
Series	GC, HC, KC, GE, HE, GF, HF	GD, HD, KD, MD GL, HL
APPLICATIONS	Framing, truss building, subflooring, sheathing, decking, siding, fencing, pallets and crate assembly	Timber frame construction, subfloors, framing, sheathing, pallets and crates, decking, furniture frame assembly

FramePro601

CLIPPED HEAD NAILER

ITEM 1G2101N



34°

Features

- Lightweight and powerful
- Toolless depth of drive
- 360° adjustable exhaust
- Nose with sawtooth for more grip
- Shorter straight-line magazine
- Adjustable trigger
- Includes case

FramePro651

CLIPPED HEAD NAILER

ITEM 2G2121N (100MM)



34°

Features

- Extra powerful
- Adjustable depth of drive
- 360° adjustable exhaust
- Nose with sawtooth for more grip
- Shorter straight-line magazine
- Comfort grip
- Includes case

SidingPro40

CLIPPED HEAD NAILER

ITEM 2Y2001N



34°

Features

- Lightweight
- EZ-Clear Nose
- Adjustable depth of drive
- Powerful

Note: Shown colours can be different

Product Reference Chart

TOOL SPECS	FramePro601	FramePro651	SidingPro40
Length	384 mm	384 mm	351 mm
Width	106 mm	106 mm	86 mm
Height	343 mm	363 mm	322 mm
Weight	3,6 kg	3,8 kg	2,1 kg
Actuation	BF(TF)	BF(TF)	BF(TF)
Air Inlet	3/8" NPT	3/8" NPT	3/8" NPT
Operating Pressure	4,8-8,3 bar	4,8-8,3 bar	4,8-8,3 bar
Air Consumption	283 l/min	312 l/min	173 l/min
Magazine capacity	70	65-70	70
Warranty	1 yr	1 yr	1 yr
FASTENER SPECS	Fasteners are located on pages 50-55		
Shank	2,9-3,3	2,9-3,3	2,3
Range	50-90mm	50-100mm	35-63mm
Angle/Collation	34° Angled Tape Strip	34° Angled Tape Strip	34° Angled Paper Tape
Series	GC, HC, KC, GE, HE, HF	GC, HC, KC, GE, HE, HF	EC, EE
APPLICATIONS	Timber frame constructions, framing, sub-floors, pallets and crates, decking, roofs, fencing, door and window frames	Timber frame constructions, framing, sub-floors, pallets and crates, decking, roofs, fencing, door and window frames	Siding, sub-floors, pallets and crates

MC60-34
METAL CONNECTOR
ITEM 6K2001N

34°



Features

- Magnesium body
- Adjustable depth of drive
- Special nose for good visibility and more precision
- Reload indicator

SN1602
FULL ROUND HEAD NAILER
ITEM 7D2001N

20°



Features

- Compact size comparing with other 160mm nailers
- Dry-fire lockout
- Cushioned grip provides greater comfort and less fatigue

Note: Only available in grey.

SN1302
FULL ROUND HEAD NAILER
ITEM 6L2001N (20°), 6L2001NX (24°)

20° 24°



Features

- Robust design for intensive use
- Available with extra handle for higher user convenience
- Adjustable depth of drive
- Reload indicator

Product Reference Chart

TOOL SPECS	MC60-34	SN1302	SN1602
Length	350 mm	533 mm	550 mm
Width	110 mm	144 mm	150 mm
Height	359 mm	478 mm	495 mm
Weight	2,7 kg	6,2 kg	7,0 kg
Actuation	TF	TF	TF
Air Inlet	¼" NPT	⅜" NPT	⅜" NPT
Operating Pressure	4,8-8,3 bar	4,8-8,3 bar	4,8-8,3 bar
Air Consumption	118 l/min	255 l/min	297 l/min
Magazine capacity	20	50-56	48-56
Warranty	1 yr	1 yr	1 yr
FASTENER SPECS	Fasteners are located on pages 50-55		
Shank	3,3-4,2	3,8-4,2	3,8-4,2
Range	40-60mm	90-130mm	100-160mm
Angle/Collation	34° Angled Plastic collated	20°/24° Angled Plastic collated	20° Angled Plastic collated
Series	NN	MD, OD	MD, OD, TD
APPLICATIONS	Shaft pre-drilled (metal) plates, shaft pre-drilled metal strips, bar carriers, anchor plates, corner anchors	Prefab, roofs, timber frame construction, sub-floors	Prefab, roofs, timber frame construction, sub-floors

S900FN

CLIPPED HEAD FRAMING NAILER

ITEM 4F2311N



34°

Features

- Adjustable depth of drive
- EZ-Clear Nose
- Comfort grip
- Adjustable exhaust
- Includes case

Product Reference Chart

TOOL SPECS	S900FN
Length	430 mm
Width	136 mm
Height	382 mm
Weight	3,8 kg
Actuation	TF
Air Inlet	¼" NPT
Operating Pressure	4,8-8,3 bar
Air Consumption	274 l/min
Magazine capacity	80
Warranty	1 yr
FASTENER SPECS	Fasteners are located on pages 50-55
Shank	2,9-3,3
Range	55-90mm
Angle/Collation	34° Angled Tape Strip
Series	GC, HC, KC, GE, HE
APPLICATIONS	Baseboards, cabinets, frames, door & window frames, skirting boards, exterior trim, furniture manufacture, dado & architrave

The difference is in the details

SENCO has set the industry standard for finish and fine woodworking tools, providing compact, ultra-light, easy-to-use tools designed for precision and longevity.

We offer a broader range of tools than anyone else, covering 15-23 gauge nailers and 15-18 gauge staplers.

APPLICATIONS

Cabinetry, furniture, decorative trim, crown molding, custom woodworking applications and all other finish needs

FEATURES

- EZ-Clear™ latch to clear jams fast
- No-mar pads to protect woodwork
- Clear line-of-sight for precision fastening
- Comfort grip
- Adjustable depth-of-drive



SENCO®

FinishPro® 23SXP

1 3/8" HEADLESS PINNER

ITEM #8F0001N



23_{GA}

Features

- Powerful — ensures complete drives into hard substrates
- Automatically adjusts for different fastener lengths
- Ergonomic handle for all-day comfort
- Ultra-narrow nose for tight corners
- Includes case, swivel air plug, wrench and tool oil

Note: Tool not available for European market (non-CE)

FinishPro® 23LXP

2" HEADLESS PINNER

ITEM #8L0001N



23_{GA}

Features

- Most powerful tool in its class — ensures complete drives into hard substrates
- Automatically adjusts for different fastener lengths
- Ergonomic handle for all-day comfort
- Ultra-narrow nose for tight corners
- Includes case, swivel air plug, wrench and tool oil

Note: Tool not available for European market (non-CE)

FinishPro® 21LXP

2" PINNER

ITEM #8M0001N



21_{GA}

Features

- Powerful — ensures complete drives into hard substrates
- Automatically adjusts for different fastener lengths
- Ergonomic handle for all-day comfort
- Ultra-narrow nose for tight corners
- Includes case, swivel air plug, wrench and tool oil

Note: Tool not available for European market (non-CE)

Pins and Brads: 23, 21 & 18 Gauge

the new
standard when
details matter

23 Ga.

21 Ga.

18 Ga.

Product Reference Chart

TOOL SPECS	FinishPro® 23SXP	FinishPro® 23LXP	FinishPro® 21LXP
Length	7.87" (200 mm)	7.87" (200 mm)	7.87" (200 mm)
Width	1.85" (44 mm)	1.85" (44 mm)	1.85" (44 mm)
Height	7.56" (192 mm)	8.89" (226 mm)	8.89" (226 mm)
Weight	2.5 lbs (1.1 kg)	2.7 lbs (1.2 kg)	3.15 lbs (1.43 kg)
Actuation	TF	TF	TF
Air Inlet	1/4" NPT	1/4" NPT	1/4" NPT
Operating Pressure	70-100 psi (4.8-7 bar)	70-110 psi (4.8-7.6 bar)	70-110 psi (4.8-7.6 bar)
Air Consumption (60 CPM)	31 l/min	31 l/min	31 l/min
Magazine capacity	100	100	100
Warranty	5 yrs	5 yrs	5 yrs
FASTENER SPECS	Fasteners are located on pages 50-55		
Gauge	23	23	21
Range	12-35mm	12-50mm	15-50mm
Capacity	126	126	170
Angle/Collation	Straight Glued Strip	Straight Glued Strip	Straight Glued Strip
Series	A10, CZ	A10, CZ	ZX
APPLICATIONS	Mouldings, glazing beads, furniture decoration, cabinets and drawers, rattan furniture	Mouldings, glazing beads, furniture decoration, cabinets and drawers, rattan furniture	Mouldings, furniture decoration, trim, beading, cabinets and drawers, rattan furniture, finishing

SLP20XP

BRAD NAILER 1,2MM

ITEM 432001N



0°

Features

- Oil free
- Lightest on the market in its class
- Easy to maintain
- EZ-Clear Nose
- Includes case

SBN10XP

BRAD NAILER 1,2MM

ITEM 8K2001N



0°

Features

- Compact design- use in tight spaces
- Superior balance with minimal recoil
- One handed magazine opening
- Short trigger stroke

SLP20XP GLN

BRAD NAILER 1,2MM

ITEM WCE0472 (4MM), WCE0485 (7MM)



0°

Features

- Oil free
- Lightest on the market in its class
- Easy to maintain
- EZ-Clear Nose
- Includes case

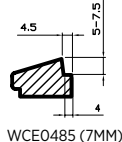
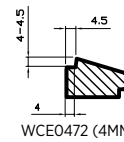
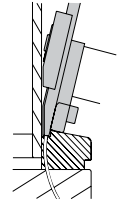

LS1XP

HEADLESS BRAD NAILER

ITEM 8N2001N



0°

Features

- Muffler ensures quieter operation
- Comfort grip
- Bottom loading magazine for quick loading
- Oil free
- Tapered nose

Product Reference Chart

TOOL SPECS	SLP20XP	SLP20XP GLN	SBN10XP	LS1XP
Length	241 mm	241 mm	255 mm	350 mm
Width	50 mm	50 mm	42 mm	110 mm
Height	210 mm	210 mm	167 mm	359 mm
Weight	1,0 kg	1,0 kg	0,9 kg	2,7 kg
Actuation	TF	TF	TF	TF
Air Inlet	¼" NPT	¼" NPT	¼" NPT	¼" NPT
Operating Pressure	4,8-8,3 bar	4,8-8,3 bar	4,5-7,0 bar	4,8-8,3 bar
Air Consumption	54 l/min	54 l/min	19 l/min	118 l/min
Magazine capacity	110	110	105	20
Warranty	5 yrs	5 yrs	5 yrs	5yrs
FASTENER SPECS	Fasteners are located on pages 50-55			
Shank	1,2	1,2	1,2	1,2
Range	16-42mm	16-42mm	12-25mm	13-25mm
Angle/Collation	Straight Glued strip	Straight Glued strip	Straight Glued strip	Straight Glued strip
Series	AX	AX	AX	AZ
APPLICATIONS	Mouldings, furniture decoration, glass slats, cabinets and drawer cabinets, rattan furniture, finishing	Window beading, secret nailing	Mouldings, furniture decoration, trim, beading, cabinets and drawers, rattan furniture, finishing	Panels, molding, finish and trim, rattan furniture, window beading, nailable plastic parts, cabinets and drawers, mirror and picture frames

FinishPro25XP

BRAD NAILER 1,2MM

ITEM 762002N



0°

Features

- Oil free
- Adjustable depth of drive
- Comfort grip
- Belt hook
- Drives both slight & medium head brads
- Includes case

FinishPro42XP

FINISH NAILER

ITEM 4G2003N



34°

Features

- Oil free
- Adjustable depth of drive
- EZ-Clear Nose
- Comfort grip
- Belt hook

FinishPro30XP

FINISH NAILER

ITEM 9P2002N



34°

Features

- Light weight
- Belt hook
- Adjustable depth-of-drive
- Adjustable exhaust
- No-Mar pad
- Includes case

TRIM ALL DAY
with the SENCOR Fusion tools

For cordless finishing nails or pinners please refer to the SENCOR Fusion Section on pages 4-5



Product Reference Chart

TOOL SPECS	FinishPro25XP	FinishPro30XP	FinishPro42XP
Length	249 mm	305 mm	330 mm
Width	56 mm	83 mm	89 mm
Height	251 mm	244 mm	292 mm
Weight	1,2 kg	1,7 kg	2,1 kg
Actuation	TF	BF(TF)	BF(TF)
Air Inlet	¼" NPT	¼" NPT	¼" NPT
Operating Pressure	4,8-8,3 bar	4,8-8,3 bar	4,8-8,3 bar
Air Consumption	54 l/min	61 l/min	110 l/min
Magazine capacity	110	104	104
Warranty	5 yrs	5 yrs	5 yrs
FASTENER SPECS	Fasteners are located on pages 50-55		
Shank	1,2	1,8	1,8
Range	16-54mm	25-50mm	32-63
Angle/Collation	Straight Glued strip	34° Angled Tape Strip	34° Angled Tape Strip
Series	AX	DA	DA
APPLICATIONS	Mouldings, furniture decoration, glass slats, cabinets and drawer cabinets, rattan furniture, finishing	Baseboards, cabinets, case goods, caskets, chair rails, decorative trim, door & window casing, sash & mill-work, exterior trim, finish applications/trim, furniture and paneling.	Baseboards, cabinets, frames, door & window frames, skirting boards, exterior trim, furniture manufacture, dado & architrave

FinishPro10

MICROPINNER 0,6MM

ITEM 2C2001N



0°

Features

- Rear exhaust
- Adjustable depth of drive
- Reload indicator
- Extra powerful
- Magazine bumper pad
- Includes case

FinishPro32

BRAD NAILER 1,6MM

ITEM 1X2202N, 1X2201N (TF + CASE)



0°

Features

- Adjustable depth of drive
- EZ-Clear Nose
- 360° adjustable exhaust
- Comfort grip
- Includes case

FinishPro18Mg

BRAD NAILER 1,2MM

ITEM 1U2025N



0°

Features

- Magnesium body
- Oil free
- Adjustable depth of drive
- Selectable trigger
- Comfort grip
- Includes case

FinishPro35Mg

FINISH NAILER

ITEM 6G2001N



34°

Features

- Adjustable depth of drive
- EZ-Clear Nose
- 360° adjustable exhaust
- Comfort grip
- Includes case

Product Reference Chart

TOOL SPECS	FinishPro10	FinishPro18Mg	FinishPro32	FinishPro35Mg
Length	225 mm	267 mm	307 mm	330 mm
Width	41 mm	64 mm	76 mm	86 mm
Height	171 mm	248 mm	267 mm	311 mm
Weight	1,1 kg	1,1 kg	1,9 kg	2,1 kg
Actuation	TF	BF(TF)	BF(TF)	BF(TF)
Air Inlet	¼" NPT	¼" NPT	¼" NPT	¼" NPT
Operating Pressure	4,8-8,3 bar	4,8-8,3 bar	4,8-8,3 bar	4,8-8,3 bar
Air Consumption	22 l/min	68 l/min	62 l/min	128 l/min
Magazine capacity	110	110	110	104
Warranty	1 yr	1 yr	1 yr	1 yr
FASTENER SPECS	Fasteners are located on pages 50-55			
Shank	0,6	1,2	1,6	1,8
Range	12-25mm	16-54mm	32-63mm	32-63mm
Angle/Collation	Straight Glued strip	Straight Glued strip	Straight Glued strip	34° Angled Tape Strip
Series	CZ	AX	RX	DA
APPLICATIONS	Mouldings, glazing beads, furniture decoration, cabinets and drawers, rattan furniture	Mouldings, furniture decoration, trim, beading, cabinets and drawers, rattan furniture, finishing	Baseboards, frames, skirting boards, trim, architrave, dado, moldings	Baseboards, cabinets, frames, door & window frames, skirting boards, exterior trim, furniture manufacture, dado & architrave

S200BN

BRAD NAILER

ITEM 922008N



0°

Features

- Adjustable depth of drive
- EZ-Clear Nose
- Comfort grip
- Adjustable exhaust
- Reload indicator
- Includes case

S250FN

FINISH NAILER

ITEM 932008N



34°

Features

- Adjustable depth of drive
- EZ-Clear Nose
- Comfort grip
- Adjustable exhaust
- Includes case

S200SM

BRAD NAILER

ITEM 942008N



0°

Features

- Robust design for intensive use
- Available with extra handle for higher user convenience
- Adjustable depth of drive
- Reload indicator
- Includes case

Product Reference Chart

TOOL SPECS	S200BN	S200SM	S250FN
Length	251 mm	254 mm	303 mm
Width	68 mm	68 mm	85 mm
Height	232 mm	230 mm	346 mm
Weight	1,4 kg	1,4 kg	2,3 kg
Actuation	TF	TF	TF
Air Inlet	¼" NPT	¼" NPT	¼" NPT
Operating Pressure	5,0-8,3 bar	5,0-8,3 bar	5,0-7,0 bar
Air Consumption	22 l/min	113 l/min	128 l/min
Magazine capacity	107-110	100	100
Warranty	1 yr	1 yr	1 yr
FASTENER SPECS	Fasteners are located on pages 50-55		
Shank	1,2	1,6	1,8
Range	16-50mm	15-50mm	32-63mm
Angle/Collation	Straight Glued strip	Straight Glued strip	34° Angled Tape Strip
Series	AX	RX	DA
APPLICATIONS	Mouldings, trim, furniture decoration, glazing beads, cupboards and drawers, general finishing	Mouldings, trim, furniture decoration, glazing beads, cupboards and drawers, general finishing	Baseboards, cabinets, frames, door & window frames, skirting boards, exterior trim, furniture manufacture, dado & architrave

GT90CH

CLIPPED HEAD FRAMING NAILER

ITEM 5F2001N, 5F7001N (UK)



34°

Features

- High voltage ignition
- Adjustable depth of drive
- Durable metal magazine
- Comfort grip
- Works in all weather conditions
- Includes case

GT35HN

HAFTEN NAILER

ITEM 3VS2001N, 3VS7001N (UK)



20°

Features

- Cordless convenience
- Powerful motor
- Durable metal magazine
- Works in all weather conditions
- Includes case

GT90FRH

FULL ROUND HEAD FRAMING NAILER

ITEM 5G2001N, 5G7001N (UK)



20°

Features

- High voltage ignition
- Adjustable depth of drive
- Durable metal magazine
- Comfort grip
- Works in all weather conditions
- Includes case

GT60NN

METAL CONNECTOR

ITEM 7N2001N, 7N7001N (UK)



34°

Features

- High voltage ignition
- Adjustable depth of drive
- Rear loading
- Overhanging nail tip for locates pre-punched holes
- Includes case

Product Reference Chart

TOOL SPECS	GT90CH	GT90FRH	GT35HN	GT60NN
Length	371 mm	371 mm	326 mm	355 mm
Width	107 mm	107 mm	136 mm	108 mm
Height	376 mm	376 mm	309 mm	393 mm
Weight	3,6 kg	3,6 kg	2,3 kg	3,6 kg
Actuation	TF	TF	TF	TF
Battery	6V 1,5 Ah Ni-MH	6V 1,5 Ah Ni-MH	6V 1,5 Ah Ni-MH	6V 1,5 Ah Ni-MH
Recharge time	2 hours	2 hours	2 hours	2 hours
Fuel cell	40g (31,5x165 mm)	40g (31,5x165 mm)	18g (31,5x80 mm)	40g (31,5x165 mm)
Magazine capacity	70	70	36	20
Warranty	2 yrs	2 yrs	2 yrs	2 yrs
FASTENER SPECS	Fasteners are located on pages 50-55			
Shank	2,9-3,3	2,9-3,3	2,5-2,8	3-3-4,2
Range	50-90mm	50-90mm	22-35mm	40-60
Angle/Collation	34° Angled Paper Tape	20° Angled Plastic collated	20° Angled Plastic collated	34° Angled Paper Tape
Series	GC, HC, KC, GE, HE	HD, KD, GL, HL	1L	NN, NP
APPLICATIONS	Timber frame, subfloors, pallets and crates, decking, shuttering, frames	Timber frame, subfloors, pallets and crates, decking, shuttering, frames	Fastening haften onto wood on roofs, tin roofs, zinc sheathing and covering. Great for any application where cordless convenience would be a benefit	Pre-drilled metal plates, pre-drilled metal strips, joist hanger

GT50AX

BRAD NAILER 1,2MM

ITEM 7R2001N, 7R7001N (UK)



0°

Features

- High voltage ignition
- Adjustable depth of drive
- EZ-Clear Nose
- Works in all weather conditions
- Includes case

GT65RHA

FINISH NAILER 1,6MM

ITEM 5S2001N, 5S7001N (UK)



20°

Features

- High voltage ignition
- Works in all weather conditions
- Adjustable depth of drive
- EZ-Clear Nose
- Includes case

GT65RHS

FINISH NAILER 1,6MM

ITEM 6D2001N, 6D7001N (UK)



0°

Features

- High voltage ignition
- Works in all weather conditions
- Adjustable depth of drive
- EZ-Clear Nose
- Includes case

GT65DA

FINISH NAILER 1,8MM

ITEM 5R2001N, 5R7001N (UK)



34°

Features

- High voltage ignition
- Adjustable depth of drive
- EZ-Clear Nose
- Works in all weather conditions
- Includes case

Product Reference Chart

TOOL SPECS	GT50AX	GT65RHA	GT65RHS	GT65DA
Length	320 mm	340 mm	312mm	318 mm
Width	86 mm	86 mm	86 mm	91 mm
Height	285 mm	340 mm	300 mm	362 mm
Weight	2,3 kg	2,1 kg	2,3 kg	2,4 kg
Actuation	TF	TF	TF	TF
Battery	6V Ni-MH	6V Ni-MH	6V Ni-MH	6V 1,5 Ah Ni-MH
Recharge time	2 hours	2 hours	2 hours	2 hours
Fuel cell	18g (31,5x80 mm)	18g (31,5x80 mm)	18g (31,5x80 mm)	18g (31,5x80 mm)
Magazine capacity	100	100	100	110
Warranty	2 yrs	2 yrs	2 yrs	2 yrs
FASTENER SPECS	Fasteners are located on pages 50–55			
Shank	1,2	1,6	1,6	1,8
Range	15-50mm	32-63mm	19-63mm	32-63mm
Angle/Collation	Straight Glued strip	20° Angled glued strip	Straight Glued strip	34° Angled Tape Strip
Series	AX	RH	RX	DA
APPLICATIONS	Molding and decorative trim, furniture trim, window beading, blind pinning of upholstered and trim panels, rattan, scribe molding, cabinets, drawers and picture frame assembly	Molding and decorative trim, furniture trim, window beading, blind pinning of upholstered and trim panels, rattan, scribe molding, cabinets, drawers and picture frame assembly	Finish and trim, baseboard, cabinets and caskets, chair rail, decorative trim, door & window, casing, furniture trim, paneling	All 2nd-fix applications including architrave, dado, skirting, casings, baseboards, frames

STRIPNAILS, PINS, BRADS AND FINISH NAILS

CLIPPED HEAD NAILS

34°

Siding Nails

Length	Point	Finish	Coating	Collation	Box Count	Item code
2.3x45mm	Diamond	Galv	Sencote	34° Angled Paper Tape	2.000	EC49AABKR
2.3x50mm	Diamond	Galv	Sencote	34° Angled Paper Tape	2.000	EC51AABKR
2.3x55mm	Diamond	Galv	Sencote	34° Angled Paper Tape	2.000	EC52AABKR
2.3x60mm	Diamond	Galv	Sencote	34° Angled Paper Tape	2.000	EC54AABKR
2.3x60mm	Diamond	Bright	Sencote	34° Angled Paper Tape	2.000	EC54APBKR
2.3x50mm	Diamond	Hot Dip	Sencote	34° Angled Paper Tape	3.000	EE51ASB
2.3x60mm	Diamond	Hot Dip	Sencote	34° Angled Paper Tape	3.000	EE54ASB

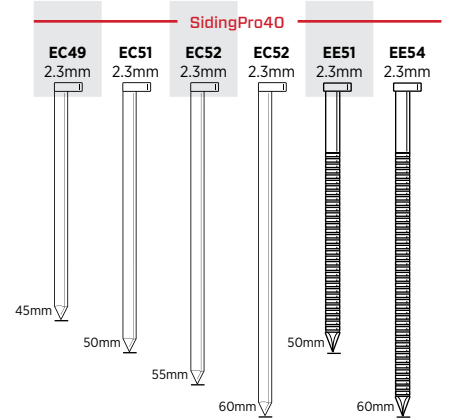

34°

Smooth Shank

Length	Point	Finish	Coating	Collation	Box Count	Item code
2.9x50mm	Diamond	Hot Dip	Sencote	34° Angled Paper Tape	2.000	GC51ASBKR
2.9x65mm	Diamond	Hot Dip	Sencote	34° Angled Paper Tape	2.000	GC55ASBKR
2.9x75mm	Diamond	Hot Dip	Sencote	34° Angled Paper Tape	2.000	GC57ASBKR
3.1x90mm	Diamond	Hot Dip	Sencote	34° Angled Paper Tape	2.000	HC59ASBKR
3.1x90mm	Diamond	Hot Dip	Sencote	34° Angled Paper Tape	2.000	HC59ESBKR
2.9x50mm	Diamond	Galv	Sencote	34° Angled Paper Tape	2.000	GC51AABKR
2.9x55mm	Diamond	Galv	Sencote	34° Angled Paper Tape	2.000	GC52AABKR
2.9x65mm	Diamond	Galv	Sencote	34° Angled Paper Tape	2.000	GC55AABKR
2.9x70mm	Diamond	Galv	Sencote	34° Angled Paper Tape	2.000	GC56AABKR
2.9x75mm	Diamond	Galv	Sencote	34° Angled Paper Tape	2.000	GC57AABKR
3.1x70mm	Diamond	Galv	Sencote	34° Angled Paper Tape	3.000	HC56AAB
3.1x75mm	Diamond	Galv	Sencote	34° Angled Paper Tape	3.000	HC57AAB
3.1x80mm	Diamond	Galv	Sencote	34° Angled Paper Tape	3.000	HC58AAB
3.1x90mm	Diamond	Galv	Sencote	34° Angled Paper Tape	3.000	HC59AAB
3.1x90mm	Diamond	Galv	Sencote	34° Angled Paper Tape	2.000	HC59AABKR
3.1x90mm	Chisel	Galv	Sencote	34° Angled Paper Tape	3.000	HC59EAB
3.1x90mm	Chisel	Galv	Sencote	34° Angled Paper Tape	2.000	HC59EABKR
3.1x90mm	Diamond	Galv	Sencote	34° Angled Paper Tape	3.000	KC59AAB
3.1x100mm	Diamond	Galv	Sencote	34° Angled Paper Tape	3.000	KC60AAB
2.9x50mm	Diamond	Bright	Sencote	34° Angled Paper Tape	2.000	GC51APBKR
2.9x55mm	Diamond	Bright	Sencote	34° Angled Paper Tape	2.000	GC52APBKR
2.9x65mm	Diamond	Bright	Sencote	34° Angled Paper Tape	2.000	GC55APBKR
2.9x70mm	Diamond	Bright	Sencote	34° Angled Paper Tape	2.000	GC56APBKR
2.9x75mm	Diamond	Bright	Sencote	34° Angled Paper Tape	2.000	GC57APBKR
2.9x80mm	Diamond	Bright	Sencote	34° Angled Paper Tape	2.000	GC58APBKR
3.1x70mm	Diamond	Bright	Sencote	34° Angled Paper Tape	3.000	HC56APB
3.1x75mm	Diamond	Bright	Sencote	34° Angled Paper Tape	3.000	HC57APB
3.1x80mm	Diamond	Bright	Sencote	34° Angled Paper Tape	3.000	HC58APB
3.1x90mm	Diamond	Bright	Sencote	34° Angled Paper Tape	3.000	HC59APB
3.1x90mm	Diamond	Bright	Sencote	34° Angled Paper Tape	2.000	HC59APBKR
3.1x100mm	Diamond	Bright	Sencote	34° Angled Paper Tape	3.000	HC60APB
3.3x90mm	Diamond	Bright	Sencote	34° Angled Paper Tape	3.000	KC59APB
3.3x100mm	Diamond	Bright	Sencote	34° Angled Paper Tape	3.000	KC60APB
3.3x100mm	Diamond	Bright	Sencote	34° Angled Paper Tape	2.000	KC60APBKR

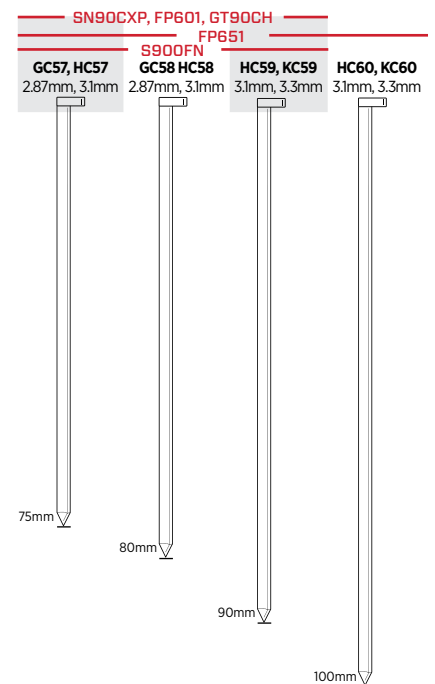
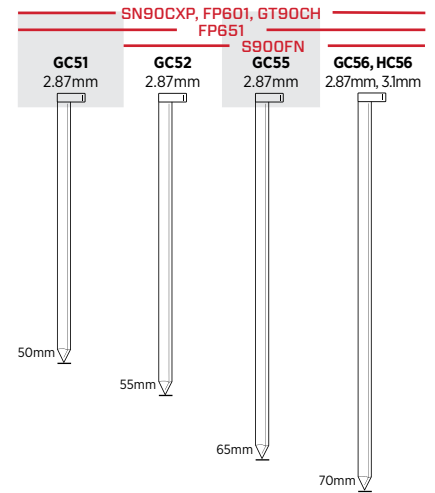

STRIPNAILS, PINS, BRADS AND FINISH NAILS

34°

Ring Shank

Length	Point	Finish	Coating	Collation	Box Count	Item code
3.1x70mm	Diamond	12mu	Sencote	34° Angled Paper Tape	3.000	HE56AXB
3.1x90mm	Diamond	12mu	Sencote	34° Angled Paper Tape	3.000	HE59AXB
2.9x65mm	Diamond	Hot Dip	Sencote	34° Angled Paper Tape	2.000	GE55ASBKR
2.9x75mm	Diamond	Hot Dip	Sencote	34° Angled Paper Tape	2.000	GE57ASBKR
3.1x90mm	Diamond	Hot Dip	Sencote	34° Angled Paper Tape	2.000	HE59ASBKR
2.9x50mm	Diamond	Galv	Sencote	34° Angled Paper Tape	2.000	GE51AABKR
2.9x60mm	Diamond	Galv	Sencote	34° Angled Paper Tape	3.000	GE54AAB
2.9x65mm	Diamond	Galv	Sencote	34° Angled Paper Tape	3.000	GE55AAB
2.9x75mm	Diamond	Galv	Sencote	34° Angled Paper Tape	3.000	GE57AAB
3.1x70mm	Diamond	Galv	Sencote	34° Angled Paper Tape	3.000	HE56AAB
3.1x80mm	Diamond	Galv	Sencote	34° Angled Paper Tape	3.000	HE58AAB
3.1x90mm	Diamond	Galv	Sencote	34° Angled Paper Tape	3.000	HE59AAB
3.3x90mm	Diamond	Galv	Sencote	34° Angled Paper Tape	3.000	KE59AAB
2.9x50mm	Diamond	Bright	Sencote	34° Angled Paper Tape	3.000	GE51APB
2.9x55mm	Diamond	Bright	Sencote	34° Angled Paper Tape	2.000	GE52APBKR
2.9x60mm	Diamond	Bright	Sencote	34° Angled Paper Tape	3.000	GE54APB
2.9x65mm	Diamond	Bright	Sencote	34° Angled Paper Tape	3.000	GE55APB
2.9x75mm	Diamond	Bright	Sencote	34° Angled Paper Tape	3.000	GE57APB
2.9x80mm	Diamond	Bright	Sencote	34° Angled Paper Tape	3.000	GE58APB
3.1x75mm	Diamond	Bright	Sencote	34° Angled Paper Tape	3.000	HE57APB
3.1x90mm	Diamond	Bright	Sencote	34° Angled Paper Tape	3.000	HE59APB
3.3x90mm	Diamond	Bright	Sencote	34° Angled Paper Tape	3.000	KE59APB

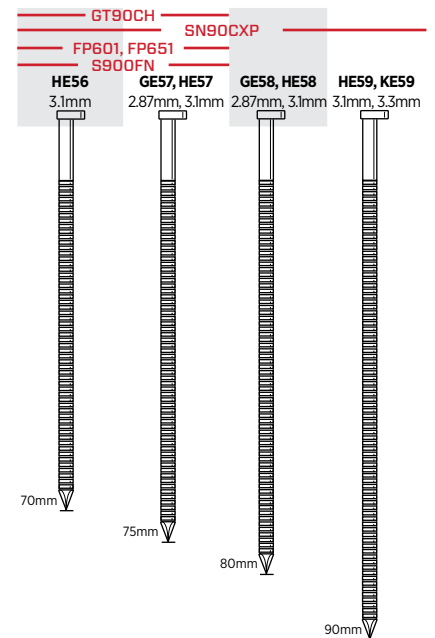
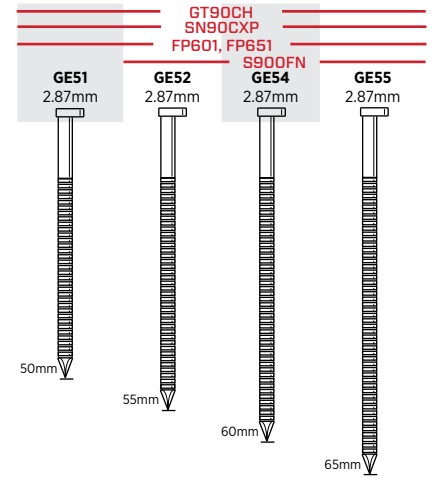

34°

Ring Shank Gas & Nail Pack



Length	Point	Finish	Coating	Collation	Box Count	Item code
2.87x50mm	Diamond	Bright	Sencote	34° Angled Paper Tape	2.000	GE51APBKR-FC
2.87x55mm	Diamond	Bright	Sencote	34° Angled Paper Tape	2.000	GE52APBKR-FC
2.87x65mm	Diamond	Bright	Sencote	34° Angled Paper Tape	2.000	GE55APBKR-FC
2.87x50mm	Diamond	12mu	Sencote	34° Angled Paper Tape	2.000	GE51AXBKR-FC
2.87x65mm	Diamond	12mu	Sencote	34° Angled Paper Tape	2.000	GE55AXBKR-FC
3.1x65mm	Diamond	12mu	Sencote	34° Angled Paper Tape	2.000	HE55AXBKR-FC
3.1x75mm	Diamond	12mu	Sencote	34° Angled Paper Tape	2.000	HE57AXBKR-FC
3.1x90mm	Diamond	12mu	Sencote	34° Angled Paper Tape	2.000	HC59AXBKR-FC

STRIPNAILS, PINS, BRADS AND FINISH NAILS

FULL ROUND HEAD NAILS

20°

Smooth Shank

Length	Point	Finish	Coating	Collation	Box Count	Item code
3.1x90mm	Diamond	Bright	Sencote	20° Angled Plastic collated	3.000	HD59APBS
3.1x90mm	Diamond	Bright	Sencote	20° Angled Plastic collated	2.000	HD59APBSR
3.8x100mm	Diamond	Bright	Sencote	20° Angled Plastic collated	1.400	MD60APBE
3.8x110mm	Diamond	Bright	Sencote	20° Angled Plastic collated	1.400	MD61APBE
3.8x120mm	Diamond	Bright	Sencote	20° Angled Plastic collated	1.400	MD63APBE
3.8x130mm	Diamond	Bright	Sencote	20° Angled Plastic collated	1.400	MD65APBE
3.8x140mm	Diamond	Galv	Sencote	20° Angled Plastic collated	1.400	MD65AABE
4.2x115mm	Diamond	Bright	Sencote	20° Angled Plastic collated	1.400	OD62APBE
4.2x130mm	Diamond	Galv	Sencote	20° Angled Plastic collated	1.400	OD65AABE
4.2x130mm	Diamond	Bright	Sencote	20° Angled Plastic collated	1.400	OD65APBE
4.6x160mm	Diamond	Bright	Sencote	20° Angled Plastic collated	500	TD70APBE

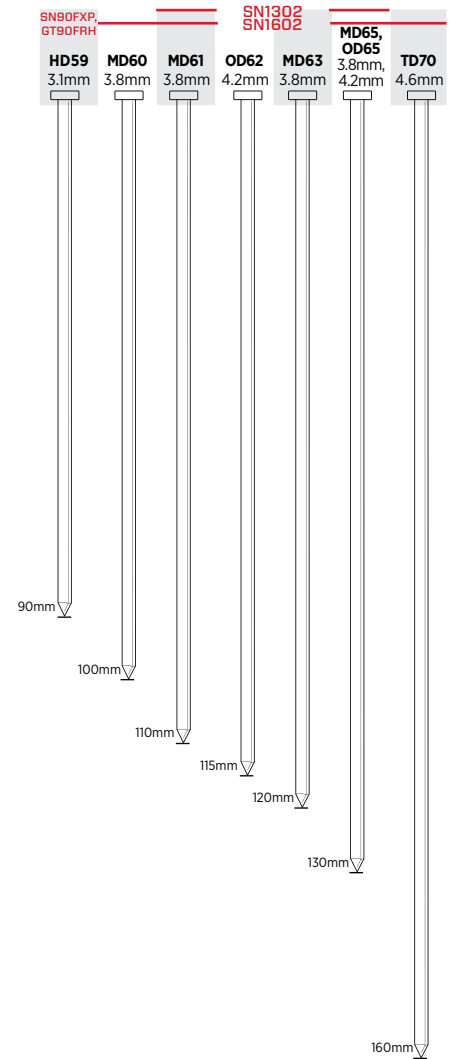

20°

Haften

Length	Point	Finish	Coating	Collation	Box Count	Item code
2.8x25mm	Diamond	Stainless 304	Plain	20° Angled Plastic collated	2.000	1L13AGAS
2.8x35mm	Diamond	Stainless 304	Plain	20° Angled Plastic collated	2.000	1L16AGAS

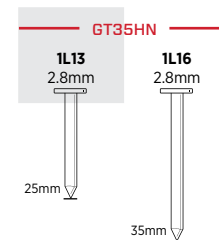

34°

Metal Connector Nails

Length	Point	Finish	Coating	Collation	Box Count	Item code
4.0x40mm	Diamond	12mu	Sencote	34° Angled Paper Tape	1.000	NN18AXBMR
4.0x50mm	Diamond	12mu	Sencote	34° Angled Paper Tape	1.000	NN21AXBMR
4.0x60mm	Diamond	12mu	Sencote	34° Angled Paper Tape	1.000	NN24AXBMR
4.0x40mm	Diamond	Stainless 304	Sencote	34° Angled Paper Tape	1.000	NN18AGBMR
4.0x50mm	Diamond	Stainless 304	Sencote	34° Angled Paper Tape	1.000	NN21AGBMR
4.0x60mm	Diamond	Stainless 304	Sencote	34° Angled Paper Tape	1.000	NN24AGBMR
4.0x40mm	Diamond	Hot Dip	Sencote	34° Angled Paper Tape	1.000	NN18ASBMR
4.0x50mm	Diamond	Hot Dip	Sencote	34° Angled Paper Tape	1.000	NN21ASBMR
4.0x60mm	Diamond	Hot Dip	Sencote	34° Angled Paper Tape	1.000	NN24ASBMR

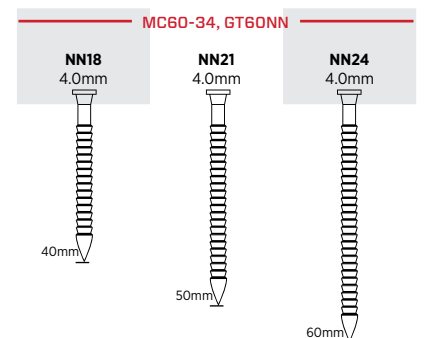

STRIPNAILS, PINS, BRADS AND FINISH NAILS

PINS

23_{GA} Pins 0.68mm

Length	Point	Finish	Coating	Collation	Box Count	Item code
12mm	Chisel	Galv	Liquor	Straight Glued strip	10.000	CZ08ECA
15mm	Chisel	Galv	Liquor	Straight Glued strip	10.000	CZ10ECA
18mm	Chisel	Galv	Liquor	Straight Glued strip	10.000	CZ11ECA
25mm	Chisel	Galv	Liquor	Straight Glued strip	10.000	CZ13ECA

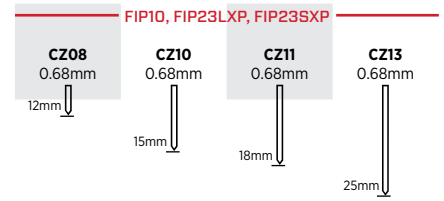

21_{GA} Medium Straight Strip Head Pins

Length	Point	Head	Finish	Coating	Collation	Box Count	Item Code
15mm	Chisel	Medium	Galv	Plain	Straight Glued Strip	5.000	ZX10EAA
25mm	Chisel	Medium	Galv	Plain	Straight Glued Strip	5.000	ZX13EAA
35mm	Chisel	Medium	Galv	Plain	Straight Glued Strip	5.000	ZX16EAA
42mm	Chisel	Medium	Galv	Plain	Straight Glued Strip	5.000	ZX18EAA
50mm	Chisel	Medium	Galv	Plain	Straight Glued Strip	5.000	ZX21EAA
15mm	Chisel	Medium	Galv	Plain	Straight Glued Strip	1.000 (CS)	ZX10EAANR
25mm	Chisel	Medium	Galv	Plain	Straight Glued Strip	1.000 (CS)	ZX13EAANR
35mm	Chisel	Medium	Galv	Plain	Straight Glued Strip	1.000 (CS)	ZX16EAANR
42mm	Chisel	Medium	Galv	Plain	Straight Glued Strip	800 (CS)	ZX18EAANR
50mm	Chisel	Medium	Galv	Plain	Straight Glued Strip	800 (CS)	ZX21EAANR

CS-Clamshell

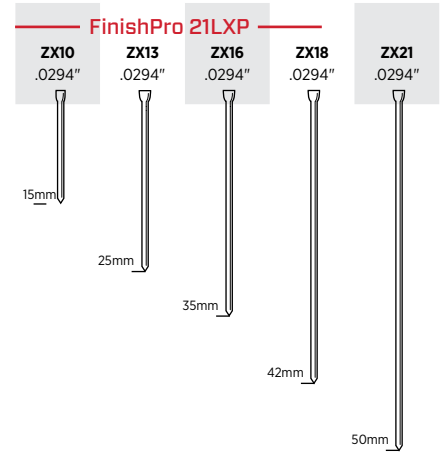

BRADS

18_{GA} Brads 1.2mm

Length	Point	Finish	Coating	Collation	Box Count	Item code
15mm	Chisel	Galv	Plain	Straight Glued strip	5.000	AX10EAAP
20mm	Chisel	Galv	Plain	Straight Glued strip	5.000	AX11EAAP
25mm	Chisel	Galv	Plain	Straight Glued strip	5.000	AX13EAAP
30mm	Chisel	Galv	Plain	Straight Glued strip	5.000	AX15EAAP
35mm	Chisel	Galv	Plain	Straight Glued strip	5.000	AX16EAAP
38mm	Chisel	Galv	Plain	Straight Glued strip	5.000	AX17EAAP
42mm	Chisel	Galv	Plain	Straight Glued strip	5.000	AX18EAAP
45mm	Chisel	Galv	Plain	Straight Glued strip	5.000	AX19EAAP
50mm	Chisel	Galv	Plain	Straight Glued strip	5.000	AX21EAAP
55mm	Chisel	Galv	Plain	Straight Glued strip	5.000	AX22EAAP
20mm	Chisel	Stainless 304	Plain	Straight Glued strip	5.000	AX11EGA
25mm	Chisel	Stainless 304	Plain	Straight Glued strip	5.000	AX13EGA
30mm	Chisel	Stainless 304	Plain	Straight Glued strip	5.000	AX15EGA
38mm	Chisel	Stainless 304	Plain	Straight Glued strip	5.000	AX17EGA
45mm	Chisel	Stainless 304	Plain	Straight Glued strip	5.000	AX19EGA
50mm	Chisel	Stainless 304	Plain	Straight Glued strip	5.000	AX21EGA

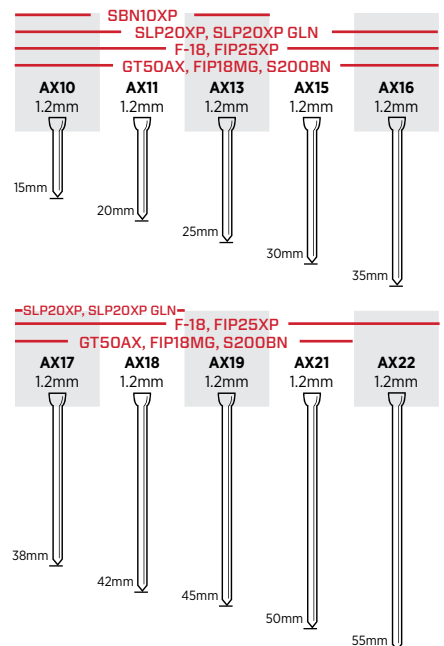

STRIPNAILS, PINS, BRADS AND FINISH NAILS

18^{GA}

Brads Slight head 1.2mm

Length	Point	Finish	Coating	Collation	Box Count	Item code
15mm	Chisel	Galv	Plain	Straight Glued strip	5.000	AY10EAAP
20mm	Chisel	Galv	Plain	Straight Glued strip	5.000	AY11EAAP
25mm	Chisel	Galv	Plain	Straight Glued strip	5.000	AY13EAAP
30mm	Chisel	Galv	Plain	Straight Glued strip	5.000	AY15EAAP
38mm	Chisel	Galv	Plain	Straight Glued strip	5.000	AY17EAAP
42mm	Chisel	Galv	Plain	Straight Glued strip	5.000	AY18EAAP
15mm	Chisel	Stainless 304	Plain	Straight Glued strip	5.000	AY10EGA
20mm	Chisel	Stainless 304	Plain	Straight Glued strip	5.000	AY11EGA
25mm	Chisel	Stainless 304	Plain	Straight Glued strip	5.000	AY13EGA
30mm	Chisel	Stainless 304	Plain	Straight Glued strip	5.000	AY15EGA
38mm	Chisel	Stainless 304	Plain	Straight Glued strip	5.000	AY17EGA

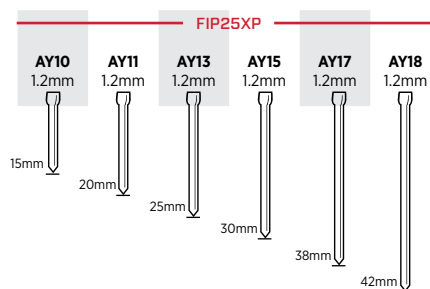

18^{GA}

Brads Headless 1.2mm

Length	Point	Finish	Coating	Collation	Box Count	Item code
13mm	Chisel	Galv	Plain	Straight Glued strip	5.000	AZ08EAAP
19mm	Chisel	Galv	Plain	Straight Glued strip	5.000	AZ11EAAP
25mm	Chisel	Galv	Plain	Straight Glued strip	5.000	AZ13EAAP

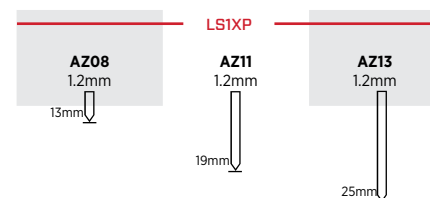

FINISH NAILS

16^{GA}
20°

Finish nails 1.6mm

Length	Point	Finish	Coating	Collation	Box Count	Item code
32mm	Chisel	Galv	Plain	20° Angled glued strip	2.000	RH15EAA
38mm	Chisel	Galv	Plain	20° Angled glued strip	2.000	RH17EAA
45mm	Chisel	Galv	Plain	20° Angled glued strip	2.000	RH19EAA
50mm	Chisel	Galv	Plain	20° Angled glued strip	2.000	RH21EAA
63mm	Chisel	Galv	Plain	20° Angled glued strip	2.000	RH25EAA
32mm	Chisel	Stainless 304	Plain	20° Angled glued strip	2.000	RH15EGA
38mm	Chisel	Stainless 304	Plain	20° Angled glued strip	2.000	RH17EGA

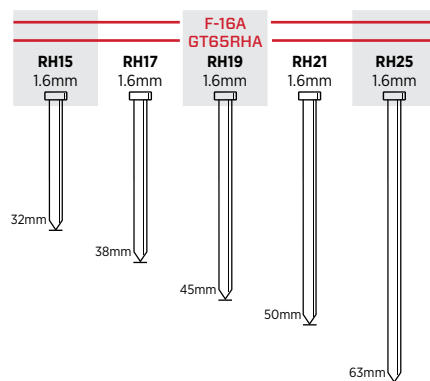

16^{GA}
20°

Finish nails 1.6mm Gas and Nail Packs



Length	Point	Finish	Coating	Collation	Box Count	Item code
32mm	Chisel	Galv	Plain	20° Angled glued strip	2.000	RH15EAA-FC
38mm	Chisel	Galv	Plain	20° Angled glued strip	2.000	RH17EAA-FC
45mm	Chisel	Galv	Plain	20° Angled glued strip	2.000	RH19EAA-FC
50mm	Chisel	Galv	Plain	20° Angled glued strip	2.000	RH21EAA-FC
63mm	Chisel	Galv	Plain	20° Angled glued strip	2.000	RH25EAA-FC

STRIPNAILS, PINS, BRADS AND FINISH NAILS

16^{GA}

Finish nails 1.6mm

Length	Point	Finish	Coating	Collation	Box Count	Item code
25mm	Chisel	Galv	Plain	Straight Glued strip	2.000	RX13EAA
32mm	Chisel	Galv	Plain	Straight Glued strip	2.000	RX15EAA
38mm	Chisel	Galv	Plain	Straight Glued strip	2.000	RX17EAA
50mm	Chisel	Galv	Plain	Straight Glued strip	2.000	RX21EAA
63mm	Chisel	Galv	Plain	Straight Glued strip	2.000	RX25EAA
32mm	Chisel	Stainless 304	Plain	Straight Glued strip	2.000	RX15EGA
35mm	Chisel	Stainless 304	Plain	Straight Glued strip	2.000	RX16EGA
38mm	Chisel	Stainless 304	Plain	Straight Glued strip	2.000	RX17EGA
50mm	Chisel	Stainless 304	Plain	Straight Glued strip	2.000	RX21EGA

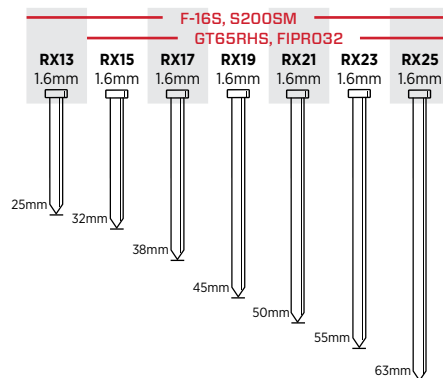

16^{GA}

Finish nails 1.6mm Gas and Nail Packs



Length	Point	Finish	Coating	Collation	Box Count	Item code
32mm	Chisel	Galv	Plain	Straight Glued strip	2.000	RX15EAA-FC
45mm	Chisel	Galv	Plain	Straight Glued strip	2.000	RX19EAA-FC
50mm	Chisel	Galv	Plain	Straight Glued strip	2.000	RX21EAA-FC
55mm	Chisel	Galv	Plain	Straight Glued strip	2.000	RX23EAA-FC
63mm	Chisel	Galv	Plain	Straight Glued strip	2.000	RX25EAA-FC

15^{GA}
34°

DA Finish Nails

Length	Point	Finish	Coating	Collation	Box Count	Item code
25mm	Chisel	Galv	Sencote	34° Angled Tape Strip	4.000	DA13EABN
32mm	Chisel	Galv	Sencote	34° Angled Tape Strip	4.000	DA15EABN
38mm	Chisel	Galv	Sencote	34° Angled Tape Strip	4.000	DA17EABN
45mm	Chisel	Galv	Sencote	34° Angled Tape Strip	4.000	DA19EABN
50mm	Chisel	Galv	Sencote	34° Angled Tape Strip	4.000	DA21EABN
56mm	Chisel	Galv	Sencote	34° Angled Tape Strip	4.000	DA23EAB
63mm	Chisel	Galv	Sencote	34° Angled Tape Strip	4.000	DA25EAB
38mm	Diamond	Hardened	Sencote	34° Angled Tape Strip	4.000	DA17AIA
45mm	Diamond	Hardened	Sencote	34° Angled Tape Strip	4.000	DA19AIA
25mm	Chisel	Stainless 304	Sencote	34° Angled Tape Strip	4.000	DA13EGB
32mm	Chisel	Stainless 304	Sencote	34° Angled Tape Strip	4.000	DA15EGB
38mm	Chisel	Stainless 304	Sencote	34° Angled Tape Strip	4.000	DA17EGB
45mm	Chisel	Stainless 304	Sencote	34° Angled Tape Strip	4.000	DA19EGB
50mm	Chisel	Stainless 304	Sencote	34° Angled Tape Strip	4.000	DA21EGB
63mm	Chisel	Stainless 304	Sencote	34° Angled Tape Strip	4.000	DA25EGB
25mm	Chisel	Aluminium	Sencote	34° Angled Tape Strip	4.000	DA13EMB
32mm	Chisel	Aluminium	Sencote	34° Angled Tape Strip	4.000	DA15EMB
38mm	Chisel	Aluminium	Sencote	34° Angled Tape Strip	4.000	DA17EMB
45mm	Chisel	Aluminium	Sencote	34° Angled Tape Strip	4.000	DA19EMB
50mm	Chisel	Aluminium	Sencote	34° Angled Tape Strip	4.000	DA21EMB

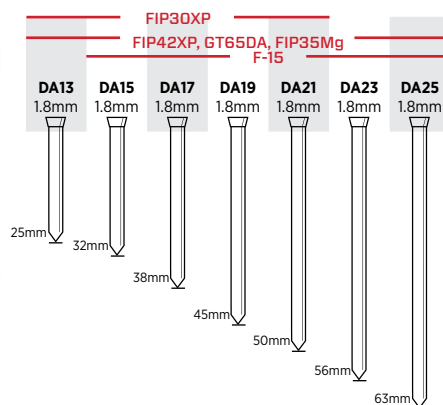



Maximize Your Cordless Convenience.



SENCO® manufactures 67 varieties of finish nails available in 4 finishes and 12 lengths.









TOOL ACCESSORIES

Tool accessories

Gas tool maintenance		
Description	ITEM #	
Gas tool lubrication 100 ml	PC1236	
Tool cleaner for gas tools 100 ml	PC1235	
Gas tool cleaning kit	PC1239	

Fuel cells		
Description	ITEM #	
Polar fuel cell 40 gr. (12pcs.)	PC1308P	
Polar fuel cell 18 gr. (12pcs.)	PC1309P	
Polar fuel cells 2 x 40 gr. (blis)	PC1307P	
Polar fuel cells 2 x 18 gr. (blis)	PC1310P	

Fusion batteries		
Description	ITEM #	
Fusion/ DuraSpin battery 18V Li-ion 1,5 Ah	VB0160EU	
Fusion/ DuraSpin battery 18V Li-ion 3,0 Ah	VB0162EU	
Fusion tools battery charger 18V Li-ion EU	VB0157EU	
Fusion tools battery charger 18V Li-ion UK	VB0159EU	

Gas tool batteries		
Description	ITEM #	
Gas tools battery 6V	VB0109EU	
Gas tool battery charger Adapter 220V	VA0058EU VB0115EU	
Gas tool battery car adaptor (12V)	PC1196	

One Common Battery Platform

SENCO'S 18-Volt Li-Ion Battery System

Designed for long running times with quick recharges, the battery operates at full speed until depleted, so there is no gradual drop in power during use. Special LED fuel gauge displays battery life at the touch of a button.

18V Li-Ion Battery 1.5 amp hour	Fits
VB0160EU (blister) VB0164EU	F-18 F-16S / F-16A F-15
18V Li-Ion Battery 3.0 amp hour	Fits
VB0162EU	F-18 F-16S / F-16A F-15
Battery Charger	For use with
VB0157EU VB0159EU (UK plug)	VB0160EU VB0164EU VB0162EU



SENCO's 18-Volt Li-Ion batteries work for all Fusion Finish Nailers and all Cordless Duraspin Auto-Feed Screw Systems.

Works with DS5525, DS5550, DS7525 models.

COILNAILS

WE COVER IT ALL

When it comes to producing pallets, roofing applications or installing siding, uptime is everything. SENCO has designed a full line of tools and fasteners to maximize your productivity.

Our new RoofPro™445XP with its innovative firing valve uses 5% less air. A bi-metal driver blade increases durability. And our power in, power out feed system is air driven for stability and speed. Our Pallet range is particularly designed for the highest demanded performances in the pallet-industry.

APPLICATIONS

SENCO offers a variety of coilnailers and crown staplers with fasteners optimized for different types of shingles, siding, sheathing, and felt underlayment.

FEATURES

- High-strength housings
- Long-lasting wear plates
- High firing capacity
- Easy, one-handed operation
- Adjustable depth-of-drive



COILNAILS

TOOLS

Pneumatic XP Heavy duty

SCN49XP	60
SCN65XP	60
RoofPro455XP	60

Heavy duty

SCN30	61
SCN34	61
CoilPro32	61
CoilPro50	61
SCN650	62
SCN75	62
CoilPro90	62

Light duty

S45CNR	63
S65CNP	63

Pallet

PAL57F	65
PAL70	65
PAL70 DUPLEX	65
PAL83	66
PAL90	66
PAL100	66
PAL100 EPAL	66
PAL130	67
EPAL MARKING NAIL	67

FASTENERS

Galvanized	68
Bright basic	69
Hot dip	71
Stainless steel A304	72

It doesn't cost a bundle
to drive the very best.



— Building Code
Approved

— Professional
Performance

RoofPro™445XP

Blows the Roof off
the Competition



SCN49XP

COILNAILER

ITEM 5J2001N



15°

Features

- Selectable trigger
- Adjustable depth of drive
- Well balanced and lightweight
- Drives wire and plastic collated flat coilnails

SCN65XP

COILNAILER

ITEM 542001N



15°

Features

- Highest power to weight ratio in its class
- Adjustable depth of drive
- High firing rate-high productivity
- EZ-load design saves time

RoofPro455XP

COILNAILER

ITEM 3D2011N



15°

Features

- Manual depth setting
- Adjustable shingle guidance
- Aluminium mainbody & cap
- Steel wearplates reduce shingle abrasion
- Jaws for nail guidance

Product Reference Chart

TOOL SPECS	SCN49XP	SCN65XP	RoofPro455XP
Length	305 mm	327 mm	260 mm
Width	128 mm	137 mm	114 mm
Height	285 mm	359 mm	267 mm
Weight	2,3 kg	3,6 kg	2,5 kg
Actuation	BF(TF)	BF(TF)	BF(TF)
Air Inlet	3/8" NPT	3/8" NPT	1/4" NPT
Operating Pressure	4,8-8,3 bar	4,8-8,3 bar	4,8-8,3 bar
Air Consumption	111 l/min	270 l/min	185 l/min
Magazine capacity	250-375	225-275	120
Warranty	5 yrs	5 yrs	5 yrs
FASTENER SPECS	Fasteners are located on pages 68-72		
Shank	2,1-2,9	2,5-3,1	3,1
Range	32-65mm	50-90mm	19-45mm
Angle/Collation	15° Conical Wire Welded Coil or Plastic Carrier Coil	15° Flat Wire Welded Coil	15° Flat Wire Welded Coil
Series	SC, ED, GD, SE, BL, EL, GL, BK	BD, GD, HD, KD, BL, GL, HL, BK, HK	HJ
APPLICATIONS	Cladding, underlayment, garden products, pallets and crates, gate and fence construction	Timber frame constructions, framing, sheathing, decking, sub-floors, pallets and crates	Asphalt shingles, tar paper, waterproof metal drip edges, paneling, cement board

SCN30

COILNAILER

ITEM SCN30



0°

Features

- Special nose for short nails
- Lightweight and compact design
- Selectable trigger
- For plastic collated coils

SCN34

COILNAILER

ITEM SCN34



15°

Features

- Selectable trigger
- Lightweight and compact design
- Adjustable depth of drive
- Includes case

CoilPro32

COILNAILER

ITEM 8Z2001N



0°

Features

- Selectable trigger
- Adjustable depth of drive
- Well balanced and lightweight
- 360° turnable exhaust

CoilPro50

COILNAILER

ITEM 4U2001N



15°

Features

- Well balanced and lightweight
- Selectable trigger
- Adjustable depth of drive
- Highest power/weight ratio in its class

Product Reference Chart

TOOL SPECS	SCN30	SCN34	CoilPro32	CoilPro50
Length	277 mm	260 mm	212 mm	305 mm
Width	98 mm	108 mm	110 mm	128 mm
Height	203 mm	302 mm	257 mm	285 mm
Weight	1,1 kg	1,6 kg	1,4 kg	2,0 kg
Actuation	BF(TF)	BF(TF)	BF(TF)	BF(TF)
Air Inlet	3/8" NPT	3/8" NPT	1/4" NPT	3/8" NPT
Operating Pressure	4,8-8,3 bar	4,8-8,3 bar	5,0-7,5 bar	4,8-8,3 bar
Air Consumption	43 l/min	44 l/min	40,2 l/min	83l/min
Magazine capacity	150-188	400	100	250-375
Warranty	1 yr	1 yr	1 yr	1 yr
FASTENER SPECS	Fasteners are located on pages 68-72			
Shank	1,6-1,8	2,1	2,5-3,1	2,1-2,3
Range	16-32mm	25-50mm	50-90mm	32-50mm
Angle/Collation	Flat Plastic carrier	15° Conical Wire Welded Coil	0° Conical Wire Welded Coil	15° Flat Wire Welded Coil
Series	RD, RL, DL	SC, SE	RC	SC, ED, SE, EL, SG, SS, BS
APPLICATIONS	Furniture, floors, fences, garden products	Furniture, floors, fences, garden products, pallets and crates	Pallets and crates, gate and fence construction	Pallets and crates, gate and fence construction, underlay, garden products, cladding

SCN650

COILNAILER

ITEM 7P2001N



0°

Features

- Ergonomically magnesium housing
- Excellent power to weight ratio
- User friendly depth of drive adjustment
- High capacity easy to load magazine

SCN75

COILNAILER

ITEM SCN75



15°

Features

- Selectable trigger
- Lightweight and compact design
- Adjustable depth of drive

CoilPro90

COILNAILER

ITEM 1VS2001N



15°

Features

- Well balanced and lightweight
- Nose with sawtooth for more grip
- Selectable trigger
- Adjustable depth of drive

Product Reference Chart

TOOL SPECS	SCN650	SCN75	CoilPro90
Length	316 mm	292 mm	306 mm
Width	145 mm	132 mm	128 mm
Height	300 mm	315 mm	317 mm
Weight	2,3 kg	2,9 kg	3,3 kg
Actuation	BF(TF)	BF(TF)	BF(TF)
Air Inlet	3/8" NPT	3/8" NPT	3/8" NPT
Operating Pressure	4,8-8,3 bar	4,8-8,3 bar	4,8-8,3 bar
Air Consumption	106 l/min	168 l/min	157 l/min
Magazine capacity	300	150-250	150-300
Warranty	1 yr	1 yr	1 yr
FASTENER SPECS	Fasteners are located on pages 68-72		
Shank	2,1-2,5	2,5-3,3	2,5-3,3
Range	32-65	45-75	45-90
Angle/Collation	Straight, Plastic Flat Wound	15° Flat Wire Welded Coil	15° Flat Wire Welded Coil
Series	SC, ED, EL, SL, BK	BJ, GD, HD, KD, BL, GL, HL, KL, BK, HK	BJ, GD, HD, KD, BL, GL, HL, KL, HK
APPLICATIONS	Wall sheathing/Siding, packaging (boxes, crates), fencing, subflooring, boarding and other wooden assembly work	Framing, sheathing/ Siding, decking, sub-flooring, exterior decks, pallets and crates	Timber frame constructions, subfloors, pallets and crates, decking, roofs, cladding

S45CNR

ROOFING COILNAILER

ITEM 1VS2004N



15°

Features

- Aluminum body
- Comfort grip
- Tool-free adjustable depth of drive
- 360 adjustable exhaust
- Includes case

S65CNP

COILNAILER

ITEM 8G2001N



15°

Features

- Magnesium body
- Comfort grip
- Multi-directional exhaust deflector
- Adjustable depth of drive
- Runs both wire and plastic collated nails
- Includes case

Product Reference Chart

TOOL SPECS	S45CNR	S65CNP
Length	300 mm	304 mm
Width	110 mm	128 mm
Height	310 mm	300 mm
Weight	2,8 kg	2,5 kg
Actuation	TF	TF
Air Inlet	¼" NPT	¼" NPT
Operating Pressure	4,8-8,3 bar	4,9-8,3 bar
Air Consumption	68 l/min	220 l/min
Magazine capacity	120	250-275
Warranty	1 yr	1 yr
FASTENER SPECS	Fasteners are located on pages 68-72	
Shank	2,31	2,3-2,9
Range	19-45	38-65
Angle/Collation	15° Conical Wire Welded Coil	15° Flat Wire Welded Coil
Series	HJ	ED, BJ, GD
APPLICATIONS	For asphalt and fiberglass shingle nailing, for both new roofs and reroofing. Also for attaching waterproof tar paper, metal drip edges and insulation board	Wall sheathing/Siding, Timber frame constructions, Fencing, Sub-flooring, Boarding and other wooden assembly work

Pallet series tools meet the demands of the industry

- Perfectly balanced
- Suitable for 24/7 use
- Light weight
- Dual actuation trigger
- Low maintenance



SENCO[®]

PAL57F

COILNAILER

ITEM PAL57F



15°

Features

- Robust design for intensive use in the pallet industry
- Side steel wearplates reduce tool abrasion
- Strong and easy to load magazine
- Well balanced and powerful

PAL70

COILNAILER

ITEM PAL70



15°

Features

- Robust design for intensive use in the pallet industry
- Well balanced and powerful
- Strong and easy to load magazine
- High durability driver and piston

PAL70 DUPLEX

COILNAILER

ITEM XL3035



15°

Features

- Robust design for intensive use in the pallet industry
- Well balanced and powerful
- Strong and easy to load magazine
- High durability driver and piston

Product Reference Chart

TOOL SPECS	PAL57F	PAL70	PAL70 DUPLEX
Length	302 mm	339 mm	339 mm
Width	133 mm	129 mm	129 mm
Height	286 mm	319 mm	319 mm
Weight	2,7 kg	3,6 kg	3,6 kg
Actuation	BF(TF)	BF(TF)	BF(TF)
Air Inlet	3/8" NPT	3/8" NPT	3/8" NPT
Operating Pressure	4,8-8,3 bar	4,8-8,3 bar	4,8-8,3 bar
Air Consumption	87 l/min	136 l/min	136 l/min
Magazine capacity	300-350	250-300	250-300
Warranty	1 yr	1 yr	1 yr
FASTENER SPECS	Fasteners are located on pages 68-72		
Shank	2,1-2,3	2,3-2,9	3,3
Range	25-57	45-70	50-70
Angle/Collation	15° Flat Wire Welded Coil	15° Flat Wire Welded Coil	15° Flat Wire Welded Coil Duplex
Series	SD, ED, SL, EL	ED, BJ, GD, EL, BL, GL, BK, GK	KR
APPLICATIONS	Pallets and crates, floors, roofs, garden products, cladding	Pallets and crates, timber, sub-floors, shuttering, roof, battens, cladding	Pallets and crates

PAL83

COILNAILER

ITEM PAL83



15°

Features

- Robust design for intensive use in the pallet industry
- Well balanced and powerful
- Strong and easy to load magazine

PAL90

COILNAILER

ITEM PAL90



15°

Features

- Robust design for intensive use in the pallet industry
- Side steel wearplates reduce tool abrasion
- Strong and easy to load magazine
- Well balanced and powerful

PAL100

COILNAILER

ITEM PAL100



15°

Features

- Robust design for intensive use in the pallet industry
- Aluminium body
- Strong and easy to load magazine
- Includes removable handle

PAL100 EPAL

COILNAILER

ITEM PAL100-EPAL



15°

Features

- Robust design for intensive use in the pallet industry
- Aluminium body
- Strong and easy to load magazine
- Includes removable handle

Product Reference Chart

TOOL SPECS	PAL83	PAL90	PAL100	PAL100 EPAL
Length	341 mm	385 mm	338 mm	338 mm
Width	132 mm	145 mm	153 mm	153 mm
Height	365 mm	370 mm	417 mm	417 mm
Weight	3,8 kg	3,5 kg	5,2 kg	5,2 kg
Actuation	BF(TF)	BF(TF)	BF(TF)	BF(TF)
Air Inlet	3/8" NPT	3/8" NPT	3/8" NPT	3/8" NPT
Operating Pressure	4,8-8,3 bar	4,8-8,3 bar	4,8-8,3 bar	4,8-8,3 bar
Air Consumption	164 l/min	193 l/min	322 l/min	322 l/min
Magazine capacity	225-300	200-300	225-300	225-300
Warranty	1 yr	1 yr	1 yr	1 yr
FASTENER SPECS	Fasteners are located on pages 68-72			
Shank	2,5-3,3	2,5-3,3	2,5-3,8	3,4
Range	38-83	50-90	55-100	70-90
Angle/Collation	15° Flat Wire Welded Coil	15° Flat Wire Welded Coil	15° Flat Wire Welded Coil	15° Flat Wire Welded Coil
Series	BJ, GD, HD, KD, BL, GL, HL, BK, HK	BJ, GD, HD, KD, BL, GL, HL, BK, HK	GD, HD, KD, MD, BL, GL, HL, BK, HK	QL
APPLICATIONS	Pallets and crates, timber, sub-floors shuttering, roof, battens, cladding	Pallets and crates, timber, sub-floors shuttering, roof, battens, cladding	Pallets and crates, timber, sub-floors shuttering, roof, battens, cladding	Pallets and crates, timber, sub-floors shuttering, roof, battens, cladding

PAL130

COILNAILER

ITEM 5M2001N



15°

Features

- Robust design for intensive use in the pallet industry
- For use in the toughest environments
- Includes removable handle
- Strong and easy to load magazine

EPAL MARKING NAIL

COILNAILER

ITEM 3D2011N-EPAL



15°

Features

- Manual depth setting
- Aluminium mainbody & cap
- Jaws for nail guidance



Product Reference Chart

TOOL SPECS	PAL130	EPAL MARKING NAIL
Length	330 mm	260 mm
Width	168 mm	114 mm
Height	457 mm	267 mm
Weight	5,9 kg	2,5 kg
Actuation	BF(TF)	BF(TF)
Air Inlet	3/8" NPT	1/4" NPT
Operating Pressure	4,8-8,3 bar	4,8-8,3 bar
Air Consumption	323 l/min	185 l/min
Magazine capacity	120-225	120
Warranty	1 yr	1 yr
FASTENER SPECS	Fasteners are located on pages 68-72	
Shank	3,8	4,2
Range	75-130	25
Angle/Collation	15° Flat Wire Welded Coil	15° Flat Wire Welded Coil
Series	MD	EPAL-MNN...
APPLICATIONS	Pallets and crates, timber, sub-floors shuttering, roof, battens, cladding	Pallet repairing

GALVANIZED

Ring Shank Coilnails



Length	Point	Finish	Coating	Collation	Box Count	Item code	XP HEAVY DUTY		HEAVY DUTY		LIGHT DUTY		PALLET					
							SCN49XP	SCN65XP	SCN34	CoilPro50	SCN75	CoilPro90	S65CNP	PAL70	PAL83	PAL90	PAL100	
2.5x50mm	Diamond	Galv.	Sencoted	15° Flat Wire Welded Coil	9.900	BL21AABF	•	•			•	•	•	•	•	•	•	
2.5x55mm	Diamond	Galv.	Sencoted	15° Flat Wire Welded Coil	7.425	BL22AABF	•	•			•	•	•	•	•	•	•	•
2.5x60mm	Diamond	Galv.	Sencoted	15° Flat Wire Welded Coil	7.425	BL24AABF	•	•			•	•	•	•	•	•	•	•
2.5x65mm	Diamond	Galv.	Sencoted	15° Flat Wire Welded Coil	7.425	BL25AABF	•	•			•	•	•	•	•	•	•	•
2.87x50mm	Diamond	Galv.	Sencoted	15° Flat Wire Welded Coil 12mu	9.000	GL21AXBF	•	•			•	•	•	•	•	•	•	
2.87x65mm	Diamond	Galv.	Sencoted	15° Flat Wire Welded Coil	6.750	GL25AABF	•	•			•	•	•	•	•	•	•	•
2.87x65mm	Diamond	Galv.	Sencoted	15° Flat Wire Welded Coil 12mu	6.750	GL25AXBF	•	•			•	•	•	•	•	•	•	•
3.1x65mm	Diamond	Galv.	Sencoted	15° Flat Wire Welded Coil	6.075	HL25AAAF		•			•	•			•	•	•	
3.1x90mm	Diamond	Galv.	Sencoted	15° Flat Wire Welded Coil	4.050	HL29AABF		•			•						•	•
2.1x32mm	Blunt	Galv.	Sencoted	15° con. Wire Welded Coil	18.900	SE15CABV	•		•	•								
2.1x38mm	Blunt	Galv.	Sencoted	15° con. Wire Welded Coil	15.750	SE17CABV	•		•	•								
2.1x32mm	Diamond	Galv.	Sencoted	15° con. Wire Welded Coil	18.900	SE15AABV	•		•	•								
2.1x38mm	Diamond	Galv.	Sencoted	15° con. Wire Welded Coil	15.750	SE17AABV	•		•	•								
2.1x45mm	Diamond	Galv.	Sencoted	15° con. Wire Welded Coil	12.600	SE19AABV	•		•	•								
2.1x50mm	Diamond	Galv.	Sencoted	15° con. Wire Welded Coil	12.600	SE21AABV	•		•	•								
2.1x35mm	Diamond	Galv.	Plain	15° con. Wire Welded Coil Drywall	17.280	SG16AAAA	•		•	•								
2.5x45mm	Diamond	Galv.	Sencoted	15° Flat Plastic 16mm Coil	7.200	BL19AABC	•				•	•	•					
2.5x55mm	Diamond	Galv.	Sencoted	15° Flat Plastic 16mm Coil	7.200	BS22AABC	•				•	•	•					
2.1x25mm	Diamond	Galv.	Plain	15° Flat Plastic 16mm Coil	16.200	SL13AAACL				•								
2.1x38mm	Diamond	Galv.	Sencoted	15° Flat Plastic 16mm Coil	9.600	SL17AABC	•		•									

Screw Shank Coilnails



Length	Finish	Collation	Box Count	Item code	XP HEAVY DUTY	
					SCN49XP	SCN75
2.5x35mm	Black	15° Flat Plastic 16mm Coil - Screwnail PZ2	7.200	NS2535SPAP	•	
2.7/3.0x25mm	Black	15° Flat Plastic 16mm Coil - Screwnail PH2	9.600	NS3035	•	
2.8/3.1x45mm	Galv. Yel.	15° Flat Plastic 16mm Coil - Screwnail TX20	7.200	NS3145/SNAPON	•	•

Smooth Shank Coilnails

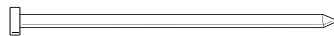

Length	Point	Finish	Coating	Collation	Box Count	Item code	XP HEAVY DUTY		HEAVY DUTY		LIGHT DUTY		PALLET					
							SCN49XP	SCN65XP	CoilPro50	SCN75	CoilPro90	S65CNP	PAL70	PAL83	PAL90	PAL100	RP455XP	SCN650
2.5x50mm	Diamond	Galv.	Sencoted	15° Flat Wire Welded Coil	9.900	BJ21AABF	•	•	•	•	•	•	•	•	•			
2.5x65mm	Diamond	Galv.	Sencoted	15° Flat Wire Welded Coil	7.425	BJ25AABF	•	•		•	•	•	•	•	•			
3.1x90mm	Diamond	Galv.	Sencoted	15° Flat Wire Welded Coil	4.050	HD29AABF		•			•			•	•			
3.1x19mm	Diamond	Galv.	Plain	15° con. Wire Welded Coil	9.720	HJ11ATAV										•		•
3.1x22mm	Diamond	Galv.	Plain	15° con. Wire Welded Coil	8.640	HJ12ATAV										•		•
3.1x25mm	Diamond	Galv.	Plain	15° con. Wire Welded Coil	7.560	HJ13ATAV										•		•
3.1x32mm	Diamond	Galv.	Plain	15° con. Wire Welded Coil	6.480	HJ15ATAV										•		•
3.1x38mm	Diamond	Galv.	Plain	15° con. Wire Welded Coil	5.400	HJ17ATAV										•		•
3.1x45mm	Diamond	Galv.	Plain	15° con. Wire Welded Coil	4.320	HJ19ATAV										•		•
2.3x38mm	Diamond	Galv.	Sencoted	0° Flat Plastic 16mm Coil	12.800	ED17AABB											•	

COILNAILS

BRIGHT BASIC

Ring Shank Coilnails



Length	Point	Finish	Coating	Collation	Box Count	Item code	XP HEAVY DUTY		HEAVY DUTY		LIGHT DUTY		PALLET						
							SCN49XP	SCN65XP	SCN30	SCN75	CoilPro90	S65CNP	PAL70	PAL83	PAL90	PAL100	PAL130	PAL100-EPAL	
2.5x75mm	Diamond	Bright	Sencoted	15° Flat Wire Welded Coil	7.425	BL27APBF		•		•	•				•	•	•		
1.8x22mm	Diamond	Bright	Sencoted	0° Flat Plastic 9mm Coil	14.850	DL12APBBS			•										
1.8x25mm	Diamond	Bright	Sencoted	0° Flat Plastic 9mm Coil	14.850	DL13APBBS			•										
2.87x40mm	Diamond	Bright	Sencoted	15° Flat Wire Welded Coil - Epal-SW	10.500	GL18APBF-EPALSW	•												
2.87x60mm	Diamond	Bright	Sencoted	15° Flat Wire Welded Coil	6.750	GL24APBF	•	•		•	•	•	•	•	•	•	•	•	
2.87x65mm	Diamond	Bright	Sencoted	15° Flat Wire Welded Coil	6.750	GL25APBF	•	•		•	•	•	•	•	•	•	•	•	
2.87x70mm	Diamond	Bright	Sencoted	15° Flat Wire Welded Coil	6.750	GL26APBF			•				•	•	•	•	•		
2.87x80mm	Diamond	Bright	Sencoted	15° Flat Wire Welded Coil	4.500	GL28APBF					•			•	•	•			
2.87x90mm	Diamond	Bright	Sencoted	15° Flat Wire Welded Coil	4.500	GL29APBF					•						•		
3.8x120mm	Diamond	Bright	Sencoted	15° Flat Wire Welded Coil	1.200	ML34APBE													•
3.4x90mm	Diamond	Bright	Sencoted	15° con. Wire Welded Coil - EPAL-SU	3.000	QL29APBF-EPALSU													•

Screw / Barbed Shank Coilnails



Length	Point	Finish	Coating	Collation	Box Count	Item code	XP HEAVY DUTY		HEAVY DUTY		LIGHT DUTY		PALLET						
							SCN49XP	SCN65XP	SCN75	CoilPro90	S65CNP	PAL57F	PAL70	PAL83	PAL90	PAL100			
2.5x40mm	Diamond	Bright	Sencoted	15° Flat Wire Welded Coil	10.800	BK18APBF	•				•								
2.5x45mm	Diamond	Bright	Sencoted	15° Flat Wire Welded Coil	9.900	BK19APBF	•		•	•	•		•			•			
2.5x55mm	Diamond	Bright	Sencoted	15° Flat Wire Welded Coil	10.800	BK22APBF	•	•	•	•	•		•	•	•	•	•		
2.5x65mm	Diamond	Bright	Sencoted	15° Flat Wire Welded Coil	7.425	BK25APBF	•	•	•	•	•		•	•	•	•	•		
2.5x70mm	Diamond	Bright	Sencoted	15° Flat Wire Welded Coil	7.425	BK26APBF			•	•			•	•	•	•			
2.5x75mm	Diamond	Bright	Sencoted	15° Flat Wire Welded Coil	7.425	BK27APBF			•	•	•			•	•	•			
2.5x80mm	Diamond	Bright	Sencoted	15° Flat Wire Welded Coil	7.425	BK28APBF								•	•	•			
2.5x85mm	Diamond	Bright	Sencoted	15° Flat Wire Welded Coil	7.425	BK85APBF													•
3.1x90mm	Diamond	Bright	Sencoted	15° Flat Wire Welded Coil	4.050	HB29APBF		•		•							•	•	

Subfloor and Sheathing Coilnails

- Superior fastening in floor applications
- Tested and proven to reduce squeaky subfloors, uneven surfaces, and raised nail heads
- Unique double rings shank design reduces the potential of nail backing out, one of the most common flooring problems

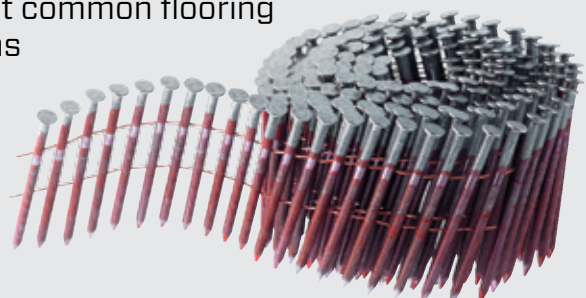

BRIGHT BASIC

Smooth Shank Coilnails



Length	Point	Finish	Coating	Collation	Box Count	Item code	XP HEAVY DUTY		HEAVY DUTY			LIGHT DUTY		PALLET						
							SCN49XP	SCN65XP	SCN34	CoilPro32	CoilPro50	SCN75	CoilPro90	S65CNP	PAL70	PAL83	PAL90	PAL100	PAL130	
2.5x50mm	Diamond	Bright	Sencoted	15° Flat Wire Welded Coil	9.900	BJ21APBF	•	•				•	•	•	•	•	•	•		
2.5x55mm	Diamond	Bright	Sencoted	15° Flat Wire Welded Coil	7.425	BJ22APBF	•	•				•	•	•	•	•	•	•	•	
2.5x60mm	Diamond	Bright	Sencoted	15° Flat Wire Welded Coil	7.425	BJ24APBF	•	•				•	•	•	•	•	•	•	•	
2.5x65mm	Diamond	Bright	Sencoted	15° Flat Wire Welded Coil	7.425	BJ25APBF	•	•				•	•	•	•	•	•	•	•	
2.5x70mm	Diamond	Bright	Sencoted	15° Flat Wire Welded Coil	7.425	BJ26APBF		•				•	•		•	•	•	•	•	
2.3x65mm	Diamond	Bright	Sencoted	15° Flat Wire Welded Coil	8.100	ED25APBH	•						•							
2.87x65mm	Diamond	Bright	Sencoted	15° Flat Wire Welded Coil	6.750	GD25APBF	•	•				•	•	•	•	•	•	•	•	
2.87x70mm	Diamond	Bright	Sencoted	15° Flat Wire Welded Coil	6.750	GD26APBF		•				•	•		•	•	•	•	•	
2.87x80mm	Diamond	Bright	Sencoted	15° Flat Wire Welded Coil	4.500	GD28APBF		•				•			•	•	•	•	•	
2.87x90mm	Diamond	Bright	Sencoted	15° Flat Wire Welded Coil	4.500	GD29APBF		•				•					•	•	•	
3.1x90mm	Diamond	Bright	Sencoted	15° Flat Wire Welded Coil	4.050	HD29APBF		•				•					•	•	•	
3.8x110mm	Diamond	Bright	Sencoted	15° Flat Wire Welded Coil	1.200	MD32APBE														•
3.8x120mm	Diamond	Bright	Sencoted	15° Flat Wire Welded Coil	1.200	MD34APBE														•
3.8x130mm	Diamond	Bright	Sencoted	15° Flat Wire Welded Coil	1.200	MD36APBE														•
1.6x25mm	Diamond	Bright	Sencoted	0° con.Wire Welded Coil	28.350	RC13APBZ					•									
1.6x32mm	Diamond	Bright	Sencoted	0° con.Wire Welded Coil	21.600	RC15APBZ					•									
2.1x32mm	Diamond	Bright	Sencoted	15° con. Wire Welded Coil	18.900	SC15APBV	•		•		•									
2.1x38mm	Diamond	Bright	Sencoted	15° con. Wire Welded Coil	15.750	SC17APBV	•		•		•									
2.1x45mm	Diamond	Bright	Sencoted	15° con. Wire Welded Coil	12.600	SC19APBV	•		•		•									
2.1x50mm	Diamond	Bright	Sencoted	15° con. Wire Welded Coil	12.600	SC21APBV	•		•		•									

Duplex



Length	Point	Finish	Coating	Collation	Box Count	Item code	PAL70DUPLEX
3.3x55mm	Diamond	Bright	Plain	15° Flat Wire Welded Coil Duplex	3.200	KR23APAH	•
3.3x65mm	Diamond	Bright	Plain	15° Flat Wire Welded Coil Duplex	3.200	KR25APAH	•
3.3x75mm	Diamond	Bright	Plain	15° Flat Wire Welded Coil Duplex	3.200	KR27APAH	•

COILNAILS

HOT DIP

Ring Shank Coilnails



Length	Point	Finish	Coating	Collation	Box Count	Item code	XP HEAVY DUTY		HEAVY DUTY		LIGHT DUTY		PALLET						
							SCN49XP	SCN65XP	SCN34	CoilPro50	SCN75	CoilPro90	S65CNP	PAL57F	PAL70	PAL83	PAL90	PAL100	
2.5x50mm	Diamond	Hot-Dipped	Sencoted	15° Flat Wire Welded Coil	2.200	BL21ASBFR	•	•			•	•	•		•	•	•		
2.5x55mm	Diamond	Hot-Dipped	Sencoted	15° Flat Wire Welded Coil	2.200	BL22ASBFR	•	•			•	•	•		•	•	•		
2.5x60mm	Diamond	Hot-Dipped	Sencoted	15° Flat Wire Welded Coil	2.200	BL24ASBFR	•	•			•	•	•		•	•	•		
2.5x65mm	Diamond	Hot-Dipped	Sencoted	15° Flat Wire Welded Coil	2.200	BL25ASBFR	•	•			•	•	•		•	•	•		
2.5x70mm	Diamond	Hot-Dipped	Sencoted	15° Flat Wire Welded Coil	2.200	BL26ASBFR		•			•	•			•	•	•		
2.5x75mm	Diamond	Hot-Dipped	Sencoted	15° Flat Wire Welded Coil	2.200	BL27ASBFR		•			•	•				•	•	•	
2.3x45mm	Diamond	Hot-Dipped	Sencoted	15° Flat Wire Welded Coil	2.400	EL19ASBHR	•			•		•	•						
2.3x50mm	Diamond	Hot-Dipped	Sencoted	15° Flat Wire Welded Coil	2.400	EL21ASBHR	•			•		•	•						
2.3x55mm	Diamond	Hot-Dipped	Sencoted	15° Flat Wire Welded Coil	2.400	EL22ASBHR	•					•	•						
2.3x60mm	Diamond	Hot-Dipped	Sencoted	15° Flat Wire Welded Coil	2.400	EL24ASBHR	•					•							
2.3x65mm	Diamond	Hot-Dipped	Sencoted	15° Flat Wire Welded Coil	2.400	EL25ASBHR	•					•							
2.87x65mm	Diamond	Hot-Dipped	Sencoted	15° Flat Wire Welded Coil	2.000	GL25ASBFR	•	•			•	•	•		•	•	•	•	
2.87x75mm	Diamond	Hot-Dipped	Sencoted	15° Flat Wire Welded Coil	6.750	GL27ASBF		•			•	•				•	•	•	
2.1x32mm	Diamond	Hot-Dipped	Sencoted	15° con. Wire Welded Coil	2.800	SE15ASBVR	•		•	•									
2.1x38mm	Diamond	Hot-Dipped	Sencoted	15° con. Wire Welded Coil	2.800	SE17ASBVR	•		•	•									
2.1x45mm	Diamond	Hot-Dipped	Sencoted	15° con. Wire Welded Coil	2.800	SE19ASBVR	•		•	•									
2.1x50mm	Diamond	Hot-Dipped	Sencoted	15° con. Wire Welded Coil	2.800	SE21ASBVR	•		•	•									
2.1x35mm	Diamond	Hot-Dipped	Plain	15° Flat Plastic 16mm Coil	8.400	SG16ASAC	•			•									
2.1x45mm	Diamond	Hot-Dipped	Plain	15° Flat Plastic 16mm Coil	7.200	SG19ASAC	•			•									
2.1x50mm	Diamond	Hot-Dipped	Plain	15° Flat Plastic 16mm Coil	8.400	SG21ASAA	•		•	•									
2.1x50mm	Diamond	Hot-Dipped	Plain	15° Flat Plastic 16mm Coil	6.000	SG21ASAC	•			•									

Screw / Knurled Shank Coilnails



Length	Point	Finish	Coating	Collation	Box Count	Item code	XP HEAVY DUTY		HEAVY DUTY		LIGHT DUTY	
							SCN49XP	CoilPro50	SCN75	CoilPro90	S65CNP	SCN650
2.5x50mm	Diamond	Hot-Dipped	Sencoted	0° Flat Plastic 16mm Coil	9.750	BK21ASBB						•
2.5x60mm	Diamond	Hot-Dipped	Plain	15° Flat Plastic 16mm Coil	4.800	BK24ASAC	•		•	•	•	
2.5x65mm	Diamond	Hot-Dipped	Sencoted	0° Flat Plastic 16mm Coil	7.800	BK25ASBB						•
2.5x35mm	Diamond	HT Galv	Plain	0° Flat Plastic 16mm Coil	15.600	BX16AIAB						•
2.5x35mm	Diamond	HT Galv	Plain	15° Flat Plastic 16mm Coil	8.400	BX16AIAC	•	•			•	

Smooth Shank Coilnails



Length	Point	Finish	Coating	Collation	Box Count	Item code	XP HEAVY DUTY			
							SCN65XP	CoilPro90	RP455XP	S45CNR
3.1x90mm	Diamond	Hot-Dipped	Sencoted	15° Flat Wire Welded Coil	900	HD29AS-BFR	•	•		
3.1x19mm	Diamond	Hot-Dipped	Plain	15° con. Wire Welded Coil	1.800	HJ11ASAVR			•	•
3.1x22mm	Diamond	Hot-Dipped	Plain	15° con. Wire Welded Coil	1.800	HJ12ASAVR			•	•
3.1x25mm	Diamond	Hot-Dipped	Plain	15° con. Wire Welded Coil	1.800	HJ13ASAVR			•	•
3.1x32mm	Diamond	Hot-Dipped	Plain	15° con. Wire Welded Coil	1.800	HJ15ASAVR			•	•
3.1x38mm	Diamond	Hot-Dipped	Plain	15° con. Wire Welded Coil	1.800	HJ17ASAVR			•	•
3.1x45mm	Diamond	Hot-Dipped	Plain	15° con. Wire Welded Coil	1.800	HJ19ASAVR			•	•

STAINLESS STEEL A304

Ring Shank Coilnails



Length	Point	Finish	Coating	Collation	Box Count	Item code	XP HEAVY DUTY		HEAVY DUTY		LIGHT DUTY		PALLET					
							SCN49XP	SCN65XP	SCN30	CoilPro50	SCN75	CoilPro90	S65CNP	PAL70	PAL83	PAL90	PAL100	
2.5x65mm	Diamond	AISI304-(A2)	Sencoted	15° Flat Wire Welded Coil	7.425	BJ25AGBF	•	•			•	•	•	•	•	•	•	•
2.5x45mm	Diamond	AISI304-(A2)	Sencoted	15° Flat Plastic 16mm Coil	7.200	BL19AGBC	•			•	•	•						
2.5x35mm	Diamond	AISI304-(A2)	Sencoted	15° Flat Plastic 16mm Coil	7.200	BS16AGBC	•			•	•	•						
2.5x45mm	Diamond	AISI304-(A2)	Sencoted	15° Flat Plastic 16mm Coil	6.000	BS19AGBC	•			•	•	•						
2.5x50mm	Diamond	AISI304-(A2)	Sencoted	15° Flat Plastic 16mm Coil	4.800	BS21AGBC	•			•	•	•						
1.8x19mm	Diamond	AISI304-(A2)	Sencoted	0° Flat Plastic 9mm Coil	18.150	DL11AGBBS			•									
1.8x25mm	Diamond	AISI304-(A2)	Sencoted	0° Flat Plastic 9mm Coil	14.850	DL13AGBBS			•									
2.3x50mm	Diamond	AISI304-(A2)	Sencoted	15° Flat Plastic 16mm Coil	6.000	ES21AGBC	•			•		•						
2.8x70mm	Diamond	AISI304-(A2)	Plain	15° Flat Wire Welded Coil	6.000	GS26AGAF		•										
2.8x80mm	Diamond	AISI304-(A2)	Plain	15° Flat Wire Welded Coil	4.500	GS28AGAF		•										
2.1x32mm	Diamond	AISI304-(A2)	Sencoted	15° Flat Plastic 16mm Coil	10.800	SL15AGBC	•			•								
2.1x40mm	Diamond	AISI304-(A2)	Sencoted	15° Flat Plastic 16mm Coil	7.200	SL18AGBC	•			•								
2.5x65mm	Diamond	AISI316-(A4)	Sencoted	15° Flat Plastic 16mm Coil	4.200	BS25AUBC	•				•	•						

Screw Shank Coilnails



Length	Finish	Collation	Box Count	Item code	XP HEAVY DUTY	
					SCN49XP	SCN75
3.2x45mm	AISI304-(A2)	15° Flat Plastic 16mm Coil - TX20	7.200	NS3245/A2/SO	•	•
3.2x65mm	AISI304-(A2)	15° Flat Plastic 16mm Coil - TX20	4.800	NS3265/A2/SO	•	•

COILNAILS

CLINCH CLIPS

UNMATCHED SPEED, COMFORT AND POWER!

The clip tools are hand-held, manually operated, lightweight pneumatic fastening tool which connects two wires together by wrapping and pressing a clip around them.

APPLICATIONS

Cages, Traps, Fencing, Aquaculture (crab pot, lobster traps, oyster trays)

FEATURES

- Quick Release Front Plate: replace driver blades without tools in seconds
- Light, well balanced, durable design ensures effortless handling
- Fastest, simplest and most trouble-free main valve in the industry
- Small contoured handle reduces fatigue, improves comfort and productivity
- Compatible with industry standard clips



Speed, comfort & power!

Discover the SENCO Clinch Clip tool-range

Choose one of our high quality Clinch Clip Tools to master your fastening job!



ACCESSORIES

Adjustable height rotating table	81
Continuous coil clipping system	81
Vertical Rotating Clipping (VRC) Machine	82
Fully Automatic SRV-1 Machine	82
Fully Automatic SHR-AK-1 & 15 Machine	82
Semi Automatic SHR-AK-1 & 15 Machine	83
Semi Automatic SHR-TRK Machine	83
Semi Automatic Locknail System	83

CLINCH CLIPS

TOOLS

Strip tools

SCT1020S	76
SCT1022S	76
SCT1024S	76
SCT1121S	76
SCT1929S	76
SCT4036S	76
SCT4139S	76
SCT4157ST	76
SCT6080S	76
SCT6082S	76
SCT6181S	76
SCT6183S	76
SCT6187ST	76
SCT6189S	76
SCT6788S	76
SCT6791ST	76
SCT1234S	76
SCT1533S	76
SCT3236S	76
SCT4050S	76
SCT4151ST	76
SCT4339S	76
SCT4528S	76
SCT4075S	76

Roll tools

SCT1020R	76
SCT1022R	76
SCT1024R	76
SCT1121R	76
SCT6081R	76
SCT6082R	76
SCT6185R	76

Roll tools

with blade jam release (ez clear)

SCT1020REZ	76
SCT1022REZ	76
SCT1024REZ	76
SCT1121REZ	76
SCT6181REZ	76
SCT6185REZ	76

Manual tool

77

FASTENERS

Clinch Clips	78
--------------	----

Strip tools

SEE ITEM # CHART



Features

- Replace driver blades without tools
- Light, well balanced, durable design ensures effortless handling
- Fastest simplest and most troublefree main valve in the industry
- Small contoured handle reduces fatigue improves comfort and productivity
- Compatible with industry standard clips

Models and Item Numbers

Description	Item Code
SCTI020S	2VS2001N
SCTI022S	2VS2002N
SCTI024S	2VS2003N
SCTI121S	2VS2004N
SCTI929S	2VS2005N
SCT4036S	2VS2019N
SCT4139S	2VS2018N
SCT4157ST	2VS2006N
SCT6080S	2VS2007N
SCT6082S	2VS2008N
SCT6181S	2VS2009N
SCT6183S	2VS2017N
SCT6187ST	2VS2022N
SCT6189S	2VS2020N
SCT6788S	2VS2010N
SCT6791ST	2VS2021N
SCTI234S	
SCTI533S	
SCT3236S	
SCT4050S	
SCT4151TS	
SCT4339S	
SCT4528S	
SCT6075S	

Roll tools

SEE ITEM # CHART



Features

- Replace driver blades without tools
- Light, well balanced, durable design ensures effortless handling
- Fastest simplest and most troublefree main valve in the industry
- Small contoured handle reduces fatigue improves comfort and productivity
- Compatible with industry standard clips

Models and Item Numbers

Description	Item Code
SCTI020R	2VS2011N
SCTI022R	2VS2012N
SCTI024R	2VS2013N
SCTI121R	
SCT6082R	
SCT6181R	
SCT6185R	

Roll tools

WITH BLADE JAM RELEASE (EZ CLEAR)

SEE ITEM # CHART



Features

- Replace driver blades without tools
- Light, well balanced, durable design ensures effortless handling
- Fastest simplest and most troublefree main valve in the industry
- Small contoured handle reduces fatigue improves comfort and productivity
- Compatible with industry standard clips

Models and Item Numbers

Description	Item Code
SCTI020REZ	2VS2015N
SCTI022REZ	2VS2016N
SCTI024REZ	2VS2023N
SCTI121REZ	2VS2024N
SCT6181REZ	
SCT6185REZ	

Product Reference Chart

TOOL SPECS	STRIP TOOLS	ROLL TOOLS	ROLL TOOLS WITH BLADE JAM RELEASE (EZ CLEAR)
Length	420 mm	380 mm	380 mm
Width	102 mm	128 mm	178 mm
Height	178 mm	204 mm	204 mm
Weight	2,0 kg	2,5 kg	2,8 kg
Air Inlet	¼" NPT	¼" NPT	¼" NPT
Operating Pressure	5,5-6,2 bar	5,5-6,2 bar	5,5-6,2 bar
Air Consumption	14,4 l/min	14,4 l/min	14,4 l/min
Magazine capacity	300mm (12") strips	13,500 - 15,000	13,500 - 15,000
Warranty	1 yr	1 yr	1 yr
APPLICATIONS	Bedding, furniture, automotive, steel ware	Bedding, furniture, automotive, steel ware	Bedding, furniture, automotive, steel ware

Manual tool



Features

- Replace driver blades without tools
- Light, well balanced, durable design ensures effortless handling
- No compressed air required
- Highly maneuverable and portable inexpensive to operate
- Compatible with industry standard clips

Manually operated clinch clip fastening tool

Hand-held, manually operated clinch clip fastening tool for assembling two wires. Great for use when compressed air is not available or practical. The SCT1000 series uses Senco clinch clips collated into 300mm strips that are loaded manually by the operator.

Please find in the tabel below which tool and clinch clip should be used in which application?

TOOL CODE	COMMON APPLICATIONS	SENCO CLIP CODE
SCT1020M	Bedding	S71A18SBP
SCT1020SM	Housing Construction Panels, Cages, Cables	S64A18SGP, S71A18SGP
SCT1022M	Bedding	S85A22SBP, S88A22SBP
SCT1024M	Bedding, 10mm Flat Border Frames	S110A18SBP
SCT1121M	Bedding, 5mm BW	S91A23SBP, S96A23SBP
SCT1234M	16ga Wires, Cable	S52A14SGP
SCT1533M	Razor Wire	S90A29SGP
SCT1929M	Cages & Traps with tight access	S64A18SGP, S71A16SAP, S71A18SBP, S71A18SGP
SCT3236M	Bedding	S72E18SBP, S78E18SBP
SCT4139M	Fencing Gabions	S110E25SSP430
SCT4151M	Crab Pots, Lobster Traps	S88F23SAP, S101F23SAP
SCT4157M	Crab Pots, Lobster Traps	S101F23SAP, S101F23SSP430, S110F25SAP
SCT6075M	Bedding, Furniture	S68H18SBP
SCT6080M	Bedding, Furniture	S74F18SBP, S74H18SBP, S74H18S-BC, S74H18SGP, S80H18SBP
SCT6082M	Bedding, Furniture	S90F18SBP, S90F18SGP, S90H18S-BP, S90H18SGP
SCT6181M	Bedding, Furniture, Crab Pots, Lobster Traps	S80F23SBP, S80H23SBP, S88F23S-BP, S88H23SBP, S88H23SBC, S88F23SAP, S88H23SAP
SCT6183M	Bedding, Crab Pots, Lobster Traps	S101H23SBP, S101H23SBC, S101H23SAP
SCT6185M	Bedding	S88F23SBP
SCT6187M	Crab Pots, Lobster Traps	S101H23SAP, S110H25SAP
SCT6189M	Bedding	S110E25SSP430, S110H25SBP, S110H25SBC
SCT6788M	Cages, Concrete Forms	S135H31SBP
SCT6791M	Crab Pots, Lobster Traps	S132F27SAP, S135H31SAP

Product Reference Chart

TOOL SPECS	MANUAL TOOLS
Length	460 mm
Width	85mm
Height	645 mm
Weight	2,5 kg
Air Inlet	-
Operating Pressure	-
Air Consumption	-
Magazine capacity	300mm (12") strips
Warranty	1 yr
APPLICATIONS	Fencing, Cages, Traps

INDEX

Example: **S 64 A 18 R B P**

1 2 3 4 5 6 7

1 Senco	2 Length	3 Width	4 Depth	5 Collation	6 Material	7 Features
A = 11mm		A = 11mm		R = Roll	A = Aluminium	P = No cushion
E = 17,5mm		E = 17,5mm		S = Strip	B = Brite Basic	C = Cushioned
F = 19mm		F = 19mm			G = Galv	
H = 22mm		H = 22mm			H = Hot Dipped Galv	
					S = Stainless Steel	

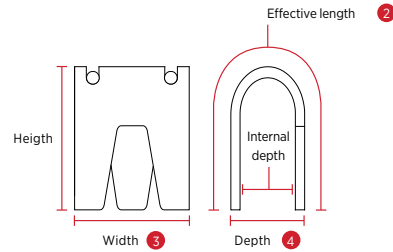

Material/finish





■ Bright Basic
 ■ Electrolytic galvanized <12μ
 ■ Hot dip galvanized
 ■ Stainless Steel
 ■ Aluminium

Senco Code	Width	Height	Depth	Internal depth	Effective length mm	Encore or Vertex clips	Hartco	Clips/Strip	Tool
S64A18SGP	11mm	10,4mm	6,6mm	4,57mm	16,25	64A18SG	CLP-15	10.340	SCT1929S
S64A18SHP	11mm	10,4mm	6,6mm	4,57mm	16,25	64A18SG	CLP-15	10.340	SCT1929S
S71A18SBP	11mm	11,4mm	6,6mm	4,57mm	18,03	71A18S	CLP-13	9.400	SCT1020S SCT1929S
S71A18SHP	11mm	11,4mm	6,6mm	4,57mm	18,03	71A18SG	CLP-13G	9.400	SCT1020S SCT1929S
S72E18SBP	17mm	11,9mm	6,6mm	4,57mm	18,28	72E18S	CLP-20	6.110	SCT4036S
S74H18SBP	22mm	12,4mm	6,6mm	4,57mm	18,79	74H18S	CLP-23	4.230	SCT6080S
S74F18SBP	19mm	12,4mm	6,6mm	4,57mm	18,79	74F18S	CLP-23I2	5.076	SCT6080S
S78E18SBP	17mm	12,4mm	6,6mm	4,57mm	19,81	78E18S	CLP-20L	5.499	SCT4036S
S80H23SBP	22mm	13,2mm	7,9mm	5,59mm	20,32	80H23S	CLP-3	3.600	SCT6181S
S80F23SBP	19mm	13,2mm	7,9mm	5,59mm	20,32	80F23S	CLP-3I2	4.320	SCT6181S
S85A22SBP	11mm	13,6mm	7,4mm	5,59mm	21,59	85A22S	CLP-33	6.720	SCT1022S
S88A22SBP	11mm	14mm	7,4mm	5,59mm	22,35	88A22S	CLP-32	6.720	SCT1022S
S88H23SBP	22mm	14,5mm	7,9mm	5,59mm	22,35	88H23S	CLP-4	3.200	SCT6181S
S88F23SBP	19mm	14,5mm	7,9mm	5,59mm	22,35	88F23S	CLP-4I2	3.840	SCT6181S
S88H23SBC	22mm	14,5mm	7,9mm	5,59mm	22,35	88H23SC	CLP-4C	3.200	SCT6181S
S88H23SGP	22mm	14,5mm	7,9mm	5,59mm	22,35	88H23SG	CLP-4G	3.200	SCT6181S
S90H18SBP	22mm	15,7mm	6,6mm	4,57mm	22,86	90H18S	CLP-24	3.290	SCT6082S
S90F18SBP	19mm	15,7mm	6,6mm	4,57mm	22,86	90F18S	CLP-24N	3.948	SCT6082S
S90H18SGP	22mm	15,7mm	6,6mm	4,57mm	22,86	90H18SG	CLP-24G	3.290	SCT6082S
S96A23SBP	11mm	15mm	7,9mm	5,85mm	24,38	96A23S	CLP-9	5.600	SCT1121S
S101H23SAP	22mm	17,3mm	7,9mm	5,59mm	25,65	101H23SAL	CLP-34AL	2.800	SCT6183S
S101F23SAP	19mm	17,3mm	7,9mm	5,59mm	25,65	101F23SAL	CLP-34NAL	3.360	SCT4157ST
S101H23SBP	22mm	17,3mm	7,9mm	5,59mm	25,65	101H23S	CLP-34	2.800	SCT6183S
S101H23SBC	22mm	17,3mm	7,9mm	5,59mm	25,65	101H23SC	CLP-34C	2.800	SCT6183S
S110H25SAP	22mm	18,4mm	8,4mm	6,35mm	27,94	110H25SAL	CLP-36AL	2.220	SCT6187ST
S110F25SAP	19mm	18,4mm	8,4mm	6,35mm	27,94	110F25SAL	CLP-36NAL	2.664	SCT4157ST
S110A18SBP	11mm	17,2mm	6,6mm	4,57mm	27,94	110A18S		6.580	SCT1024S
S110H25SBP	22mm	18,4mm	8,4mm	6,35mm	27,94	110H25S	CLP-36	2.220	SCT6189S
S110H25SBC	22mm	18,4mm	8,4mm	6,35mm	27,94	110H25SC	CLP-36C	2.220	SCT6189S
S110H25SGP	22mm	18,4mm	8,4mm	6,35mm	27,94	110H25SG	CLP-36G	2.220	SCT6189S
S110E25SSP430	17mm	18,4mm	8,4mm	6,35mm	27,94	110E25SS430	CLP-35SS430	1.443	SCT6189S
S110E25SSP434	17mm	18,4mm	8,4mm	6,35mm	27,94	110E25SS434	CLP-35SS434	1.443	SCT6189S
S112DH25SBP	22mm	17,5mm	8,4mm	6,35mm	28,44	112DH25S	CLP-36I0	3.108	SCT4139S

CLINCH CLIPS

Senco Code	Width	Height	Depth	Internal depth	Effective length mm	Encore or Vertex clips	Hartco	Clips/Strip	Tool
S101F23SSP430	19mm	17,3mm	7,9mm	5,59mm	22,35	101F23SS4	CL-34NS430	3.360	SCT4157TS
S110H25SAP	22mm	18,4mm	8,4mm	6,35mm	27,94	110H25SAL	CL-36AL	2.220	SCT6187TS
S68H18SBP	22mm	11,8mm	6,6mm	4,57mm	16,25	68H18S	CLP-22	4.700	SCT6075S
S71A16SAP	11mm	11,4mm	6,6mm	4,57mm	18,04	71A16SAL	CLP-13AL	9.400	SCT1929S
S74F18SGP	19mm	12,4mm	6,6mm	4,57mm	16,25	74F18SG	CLP-2312G	5.076	SCT4050S
S74H18SBC	22mm	12,4mm	6,6mm	4,57mm	16,25	74H18SC	CLP-23C	4.230	SCT6080S
S74H18SGP	22mm	12,4mm	6,6mm	4,57mm	16,25	74H18SG	CLP-23G	4.230	SCT6080S
S80H18SBP	22mm	13,2mm	6,6mm	4,57mm	16,25	80H18S	CLP-25	4.230	SCT6080S
S88F23SAP	19mm	14mm	7,9mm	5,59mm	22,35	88F23SAL	CLP-4NAL	3.840	SCT4151TS
S88H23SAP	22mm	14mm	7,9mm	5,59mm	22,35	88H23SAL	CLP-4AL	3.200	SCT6181TS
S90A29SGP	11mm	15,7mm	10,4mm	4,57mm	22,86	90A29SG		5.220	SCT1533S
S90F18SGP	19mm	15,7mm	6,6mm	4,57mm	16,25	90F18SG	CLP-2412G	3.948	SCT6082S
S91A23SBP	11mm	14,2mm	7,9mm	5,59mm	22,35	91A23S	CLP-14	5.600	SCT1121S
S125A38SGP	11mm	17,5mm	12,7mm	9,65mm	31,75	125A38SG	CLP-61G	3.000	on request
S125A38SSP4	11mm	17,5mm	12,7mm	9,65mm	31,75	125A38SS4	CLP-61SS430	3.000	on request
S132A38SBP	11mm	18,3mm	12,7mm	9,65mm	33,52	132A38S	CLP-64	3.000	on request
S132A38SGP	11mm	18,3mm	12,7mm	9,65mm	33,52	132A38SG	CLP-64G	3.000	on request
S132A38SSP4	11mm	18,3mm	12,7mm	9,65mm	33,52	132A38SS4	CLP-64SS430	3.000	on request
S135F31SAP	19mm	21,8mm	9,5mm	7,87mm	34,29	135F31SAL	WA40	1.550	SCT6791ST
S135H31SBP	22mm	21,8mm	9,5mm	7,87mm	34,29	135H31S	CLP-38	1.550	SCT6788S
S135H31SGP	22mm	21,8mm	9,5mm	7,87mm	34,29	135H31SG	CLP-38G	1.550	SCT6788S

Senco Code	Width	Height	Depth	Internal depth	Effective length mm	Encore or Vertex clips	Hartco	Clips/Roll	Tool
S64A18RBP	11mm	10,4mm	6,6mm	4,57mm	16,25	64A18R	CCP-15	15.000	SCT1020R, SCT1020REZ
S71A18RBP	11mm	11,4mm	6,6mm	4,57mm	18,03	71A18R	CCP-13	15.000	SCT1020R, SCT1020REZ
S73A18RBP	11mm	12,2mm	6,6mm	4,57mm	18,54	73A18R	CCP-19	14.000	SCT1020R, SCT1020REZ
S76A18RBP	11mm	13mm	6,6mm	4,57mm	19,30	76A18R	CCP-26	14.500	SCT1020R, SCT1020REZ
S76A22RBP	11mm	13mm	7,4mm	5,59mm	19,30	76A22R		12.300	SCT1022R, SCT1022REZ
S80A22RBP	11mm	13,2mm	7,4mm	5,59mm	20,32	80A22R		13.700	SCT1022R, SCT1022REZ
S85A18RBP	11mm	13,6mm	6,6mm	4,57mm	21,59	85A18R	CCP-30	13.500	SCT1020R, SCT1022R, SCT1020REZ, SCT1022REZ
S85A22RBP	11mm	13,6mm	7,4mm	5,59mm	21,59	85A22R	CCP-33	12.300	SCT1022R, SCT1022REZ
S88A22RBP	11mm	14mm	7,4mm	5,59mm	22,35	88A22R	CCP-32	12.300	SCT1022R, SCT1022REZ
S96A23RBP	11mm	15mm	7,9mm	5,85mm	24,38	96A23R	CCP-9	10.000	SCT1121REZ
S110A18RBP	11mm	17,2mm	6,6mm	4,57mm	27,94	110A18R		9.300	SCT1024R, SCT1024REZ

Senco Code			Hartco	Clips/Coil	
SHR-AK-15			HR-AK-15	1.000	
SHR-AK-1			HR-AK-1	1.000	
SHR-TRK			HR-TRK-1	1.250	
Senco Code			Encore or Vertex clip	Clips/Coil	
SRV-1			ACE1-/RV-1	1.500	
Senco Code			Encore or Vertex clip	Clips/Coil	
SHR-LN-2			HR-LN-2	2.500	
SHR-LN-3			HR-LN-3	2.500	

Paper covered wire (Silent wire)

Senco Code	Gauge	Length	Hartco	Qty	
SPCW16400	16g (4mm)	4000 feet (1219m)	PCW164000	1	
SPCW16400-23	16g (4mm)	Pre cut length 23" (584mm)		250/bundle	
SPCW16400-35	16g (4mm)	Pre cut length 35" (889mm)		250/bundle	

CLINCH CLIPS ACCESSORIES

Adjustable Height Rotating Table

ITEM 2VS2026N



Features

- Rotates wireframes into position so operator can quickly and easily apply clips
- Raise or lower the table to ideal height for assembly position
- Heavy duty welded frame adjusts easily with hand crank, no wrench required
- Stable, easy-to-clean working surface

Continuous Coil Clipping System

TOOL COUNTER BALANCE SYSTEM SEMI-AUTO*

ITEM 2VS2025N



Features

- Easy load clip feed rail, fastener reloading, less downtime
- Counterbalanced tool decreases fatigue for the operator
- Specifically designed for high volume production environments

*Useable with an clinching tool equipped with a hanger (not included).

Product Reference Chart

TOOL SPECS	Adjustable Height Rotating Table	Continuous Coil Clipping System
Length	76 mm	1470 mm
Width	1980 mm	1170 mm
Height	1830 mm	2440 mm
Weight	90,7 kg	40,8 kg
Warranty	1 yr	1 yr
APPLICATIONS	Heavy duty, freely rotating table on an adjustable height frame for use in mattress assembly (bedding)	Continuous coil clipping system used for bedding and furniture applications.

CLINCH CLIPS ACCESSORIES

Vertical Rotating Clipping (VRC) Machine



Features

- Specifically designed for high volume production environments
- Programmable to automatically load, rotate and clip mattress frames and springs together
- Minimal operator interaction required
- Up to 13,000 clips can be applied per hour

Fully Automatic SRV-1 Machine



Features

- Minimal operator interaction required
- Automated furniture rail feed system
- Super fast clipping speed exceeds 2 clips per second (7,200 applied per hour)
- Programmable clip spacing, in inches or millimeters
- Storage capacity for thousands of rail recipes
- 10" touch screen makes programming fast and intuitive
- High capacity exit table keeps rails from falling on floor during large quantity runs
- Infinitely adjustable head height option

Fully Automatic SHR-AK-1 & 15 Machine



Features

- Programmable clip spacing, in inches or millimeters
- Minimal operator interaction required
- Automated furniture rail feed system
- Infinitely adjustable head height option
- High capacity: 3,000 to 4,000 clips can be applied per hour
- 10" touch screen makes programming fast and intuitive
- High capacity exit table keeps rails from falling on floor during large quantity runs

Product Reference Chart

TOOL SPECS	Vertical Rotating Clipping (VRC) Machine	Fully Automatic SRV-1 Machine	Fully Automatic SHR-AK-1 & 15 Machine
Length	4057mm	1800mm	1800mm
Width	1680mm	4900mm	4900mm
Height	2440mm	1800mm	1800mm
Weight	544,3kg	295kg	295kg
Warranty	1 yr	1 yr	1 yr
FASTENER SPECS		SRV-1/ACE-1/RV-1	SHR-AK-1/SHR-AK-15/ AK-1/AK-15
APPLICATIONS	Programmable machine that clips mattress border wire frames to perimeter coils of inner springs automatically	Automatically feeds furniture rails for precision placement of SRV-1 spring anchor clips to furniture frames	Automatically feeds furniture rails for precision placement of SHR-AK-1 and SHR-AK-15 spring anchor clips to furniture frames

CLINCH CLIPS ACCESSORIES

Semi Automatic SHR-AK-1 & 15 Machine



Features

- Sensor determines accurate and consistent clip-to-clip spacing
- Operator uses knee switch to position first clip
- Infinitely adjustable head height option
- 2,000 to 2,500 clips can be applied per hour

Semi Automatic SHR-TRK Machine



Features

- Sensor determines accurate and consistent clip-to-clip spacing
- Operator uses knee switch to position first clip
- Infinitely adjustable head height option
- 2,000 to 2,500 clips can be applied per hour

Semi Automatic Locknail System



Features

- Foot control valve
- Easy to load and replace LockNails on spindle

Product Reference Chart

TOOL SPECS	Semi Automatic SHR-AK-1 & 15 Machine	Semi Automatic SHR-TRK Machine	Semi Automatic Locknail System
Length	1300mm	1300mm	1300mm
Width	2800mm	2800mm	2800mm
Height	1200mm	1200mm	1200mm
Weight	150kg	150kg	150kg
Warranty	1 yr	1 yr	1 yr
FASTENER SPECS	SHR-AK-1/SHR-AK-15/AK-1/AK-15	SHR-TRK/TRK	HR-LN-2/HR-LN-3
APPLICATIONS	Allows precision placement of seat rail spring anchor clips SHR-AK-1 and SHR-AK-15	Allows precision placement of top of the rail spring anchor clips SHR-TRK	Secures full-hard galvanized steel fasteners to cardboard or composite panels

SPECIALIST APPLICATIONS

Senco specialise in meeting the demands of a wide and complex range of in-plant and on-site fastening applications.

The **GT40FS** gas powered fencing stapler is a perfect example of where Senco provided the perfect solution for constructing post and wire fences on-site fast and effectively without the need for an additional power source.

Senco **Industrial Plier staplers** are heavy-duty pneumatic plier tools for professional end users. Characteristic for these tools are quiet and fast stapling, low weight and ergonomically balanced design. The various anvil configurations allow the customer to select an option suitable for their specific fastening application. Senco Plier tools are typically used in bedding and packaging applications.

The **SC15** corrugated fastener tool can be used for the production of crates, furniture, door and window frames where butt and mitre joints in soft timber are required. Senco corrugated fasteners used in-conjunction with the SC15 corrugated fastening tool will provide secure joints and speed up your manufacturing processes.



TOOLS

Pneumatic

DFPXP	86
F75LXP	86
F75SXP	86
FAT25	86

SC15	87
TPRO65	87
GT40FS	87
BC58	88
A20	88
SHT-F	88

FASTENERS

Corrugated Fastener	89
T-Nails	89
Fencing Staples	89
Button Cap Staples	89

SENCOR[®]

CORRUGATED FASTENERS

Senco corrugated fasteners provide twice the joint strength of ordinary fasteners. Use this fastener for butt and mitre joints, truss constructions, wooden boxes, pallet repair, cabinet and furniture frames.

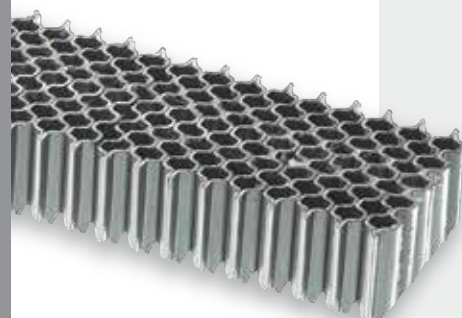

DFPXP

PLIER TOOL

ITEM 8H2001N

20_{GA}



Features

- High capacity (230 staples) magazine
- Comfort grip
- 175mm throat allows for extended reach into cartons
- Tool-free adjustable anvil opening

F75LXP

PLIER TOOL

ITEM 8J2002N

18_{GA}



Features

- High capacity (152 staples) magazine
- Comfort grip
- 175mm throat allows for extended reach into cartons
- Tool-free adjustable anvil opening

F75SXP

PLIER TOOL

ITEM 8J2001N

18_{GA}



Features

- High capacity (152 staples) magazine
- Comfort grip
- Tool-free adjustable anvil opening

FAT25

PLIER TOOL

ITEM FAT25

21_{GA}



Features

- The jaw opening is adjustable by simply turning the screw on the top of the tool
- Comfort grip
- Rear exhaust
- Bottom load double length magazine
- Jaw openings are both wide and deep

Product Reference Chart

TOOL SPECS	DFPXP	F75LXP	F75SXP	FAT25
Length	380 mm	380 mm	380 mm	380 mm
Width	75 mm	75 mm	75 mm	75 mm
Height	327 mm	327 mm	327 mm	327 mm
Weight	2,2 kg	2,2 kg	2,2 kg	2,2 kg
Actuation	TF	TF	TF	TF
Operating Pressure	4,5-7,0 bar	4,5-7,0 bar	4,5-7,0 bar	4,5-7,0 bar
Air Inlet	¼" NPT	¼" NPT	¼" NPT	¼" NPT
Air Consumption	26 l/min	33 l/min	33 l/min	33 l/min
Magazine capacity	230	230	230	170
Warranty	1 yrs	1 yrs	1 yrs	1 yrs
FASTENER SPECS	Fasteners are located on pages 29-30			
Crown	12,7	11,9	11,9	12,7
Range	8-16mm	10-16mm	10-16mm	8-25mm
Angle/Collation	Straight Glued and Taped Strip	Straight Glued and Taped Strip	Straight Glued and Taped Strip	Straight Glued and Taped Strip
Series	F	J	J	AT
APPLICATIONS	Corrugated box fabrication, packaging, displays, light assembly	Corrugated box fabrication, bed manufacturing, packaging	Corrugated box fabrication, bed manufacturing, packaging	Mattress plastic and cloth stapling, upholstered, furniture, plastic tanks (paint bins etc.), cardboard packaging

SC15

CORRUGATED FASTENER

ITEM 6N2001N



0°

Features

- Magnesium body
- Adjustable depth of drive
- Selectable trigger
- Sharp angled nosepiece to fit into corners

TPR065

T-NAILER

ITEM 1VS2002N



0°

Features

- Strong and lightweight body
- Special hardened driver blade
- 360° adjustable exhaust
- Drives into concrete, steel & wood

GT40FS

CORDLESS FENCING STAPLER

ITEM 3VS2002N, 3VS7002N (UK)



Features

- Cordless convenience
- Powerful motor
- Consistent drives in all weather conditions
- Tool-free depth-of-drive
- Includes case

Product Reference Chart

TOOL SPECS	SC15	TPR065	TOOL SPECS	GT40FS
Length	300 mm	283 mm	Length	373 mm
Width	82 mm	98 mm	Width	108 mm
Height	282 mm	305 mm	Height	356 mm
Weight	2,4 kg	2,7 kg	Weight	3,7 kg
Actuation	BF(TF)	BF(TF)	Actuation	TF
Air Inlet	¼" NPT	¼" NPT	Battery	6V 1,5 Ah Ni-MH
Operating Pressure	4,8-8,3 bar	4,8-8,3 bar	Recharge time	2 hours
Air Consumption	99 l/min	88 l/min	Fuel cell	40g (31,5x165 mm)
Magazine capacity	73	80	Magazine capacity	78
Warranty	1 yr	1 yr	Warranty	1 yr
FASTENER SPECS	Fasteners are located on page 89		FASTENER SPECS	Fasteners on page 89
Shank	NA	2,2mm	Shank	3,1mm
Range	9-15mm	18-64mm	Range	25-40mm
Angle/Collation	Glued	Straight Glued strip	Angle/Collation	Taped
Series	X	PH	Series	31FS
APPLICATIONS	Butt and miter joints, truss construction, window frames, wooden boxes, pallet repair, cabinet and furniture frames.		APPLICATIONS	Fencing, agriculture, gardening, wire-to-wood stapling
	Trackless carpet strip, wood furring, floor underlayment, installation of metal drywall track			

BC58

BUTTON CAP STAPLER

ITEM 4A0001N

**Features**

- Easy load system for staples and 25,4mm cap
- Light weight aluminium housing
- Comfort grip
- Balanced and fast for high production

**A20**

PALM HAND NAILER

ITEM PC0781

**Features**

- Drives loose nails 50-90mm
- Magnetic nail guide
- Soft rubber grip

SHT-F

HAMMERTACKER

ITEM 6R2001N

**Features**

- Durable construction
- Comfortable anti-slip
- Quick loading

Product Reference Chart

TOOL SPECS	BC58	A20	SHT-F
Length	211 mm	101 mm	300 mm
Width	52 mm	83 mm	30 mm
Height	197 mm	122 mm	58 mm
Weight	1,2 kg	1,1 kg	1,1 kg
Actuation	TF	-	-
Air Inlet	¼" NPT	⅜" NPT	-
Operating Pressure	4,8-8,3 bar	3,5-8,3 bar	-
Air Consumption	323 l/min	57-113 l/min	-
Magazine capacity	120-225	-	-
Warranty	1 yr	1 yr	1 yr
FASTENER SPECS	Fasteners are located on page 89		Fasteners are located on 29-30
Range	16mm	-	6-10mm
Series	M004092, M004085	-	F
APPLICATIONS	House wrap installation, roofing felt, lumber protection with foil	Metal connector straps, ties, joist hangers and anchors.	Upholstery, house wrapping, carpet and underlayment, plastic.

CORRAGATED FASTENER

25_{GA}

Sencor 25.4mm Crown Corrugated Fastener

Length	Point	Finish	Coating	Collation	Box Count	Item code
9,5mm	Sharp Chisel	Bright	Plain	Glued	5.000	X06NGA
9,5mm	Sharp Chisel	Bright	Plain	Glued	5.000	X06NRA
12,7mm	Sharp Chisel	Bright	Plain	Glued	4.000	X08NRA
15,9mm	Sharp Chisel	Bright	Plain	Glued	3.400	X10NRA

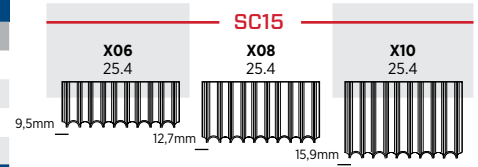

T-NAILS

T-nails

Length	Point	Finish	Coating	Collation	Box Count	Item code
2.2x25mm	Diamond	Galv	Plain	Straight Glued strip	2.000	PH13AAA
2.2x32mm	Diamond	Galv	Plain	Straight Glued strip	2.000	PH15AAA
2.2x38mm	Diamond	Galv	Plain	Straight Glued strip	1.000	PH17AAA
2.2x50mm	Diamond	Galv	Plain	Straight Glued strip	1.000	PH21AAA
2.2x60mm	Diamond	Galv	Plain	Straight Glued strip	1.000	PH24AAA
2.2x64mm	Diamond	Galv	Plain	Straight Glued strip	1.000	PH25AAA
2.2x38mm	Diamond	Stainless 304	Plain	Straight Glued strip	1.000	PH17AGA
2.2x50mm	Diamond	Stainless 304	Plain	Straight Glued strip	1.000	PH21AGA
2.2x60mm	Diamond	Stainless 304	Plain	Straight Glued strip	1.000	PH24AGA
2.2x64mm	Diamond	Stainless 304	Plain	Straight Glued strip	1.000	PH25AGA
2.2x25mm	Diamond	Hardened	Plain	Straight Glued strip	2.000	PH13AIA
2.2x32mm	Diamond	Hardened	Plain	Straight Glued strip	2.000	PH15AIA
2.2x38mm	Diamond	Hardened	Plain	Straight Glued strip	1.000	PH17AIA
2.2x45mm	Diamond	Hardened	Plain	Straight Glued strip	1.000	PH19AIA
2.2x50mm	Diamond	Hardened	Plain	Straight Glued strip	1.000	PH21AIA
2.2x57mm	Diamond	Hardened	Plain	Straight Glued strip	1.000	PH23AIA
2.2x64mm	Diamond	Hardened	Plain	Straight Glued strip	1.000	PH25AIA

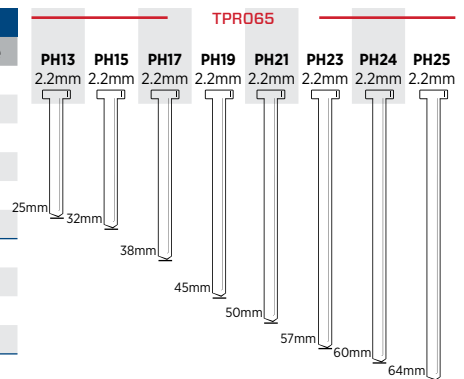

FENCING STAPLES

11_{GA}

31-staple

Length	Point	Finish	Coating	Collation	Box Count	Item code
33mm	Div	Hdg	Plain	Taped	2.700	31FS33FAAT
40mm	Div	Hdg	Plain	Taped	2.100	31FS40FAAT

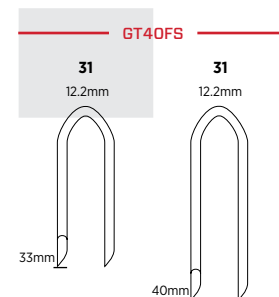

BUTTON CAP STAPLES

Button cap staple packs, 25,4mm caps

Length	Point	Finish	Coating	Collation	Box Count	Item code
16mm	Chisel	Galv	Plain	Glued	2.200	M004085
16mm	Chisel	Galv	Plain	Glued	2.200	M004092
25,4mm	-	Plastic	-	Laser Weld	2.200	-

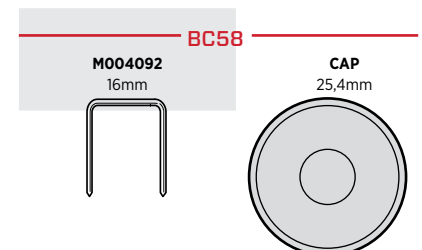

SCREW AND DRILL DRIVERS

A TOUGH ACT TO FOLLOW

SENCO industrial screwdrivers are automated pneumatic tools that are used to drive screws while providing close control of the screw torque. The tools are designed to improve productivity and reliability.

APPLICATIONS

Pneumatic screwdrivers are suitable for low-torque applications such as woodworking or sheet metal repair.

FEATURES

- Composite housing
- Low noise
- Direct torque control
- Push-in start
- Low maintenance cost



SCREW AND DRILL DRIVERS

TOOLS

Pneumatic

SEN510C	92
SEN511C	92
SEN600C	92
SEN602C	92
SEN610C	93
SEN611C	93
SEN612C	93
SEN700C	93

SEN510C
PNEUMATIC DRILL

ITEM SEN510C



Features

- Composite housing
- Comfort grip
- Low noise - 83 dB(A)
- Direct drive
- Reversible motor
- Low maintenance cost

SEN511C
PNEUMATIC DRILL

ITEM SEN511C



Features

- Composite housing
- Comfort grip
- Low noise - 83 dB(A)
- Direct drive
- Reversible motor
- Low maintenance cost

SEN600C
PNEUMATIC SCREWDRIVER

ITEM SEN600C



Features

- Composite housing
- Low noise - 83 dB(A)
- Direct torque control
- Push-in start
- Low maintenance cost

SEN602C
PNEUMATIC SCREWDRIVER

ITEM SEN602C



Features

- Composite housing
- Low noise - 83 dB(A)
- Direct torque control
- Reversible motor
- Low maintenance cost

Product Reference Chart

TOOL SPECS	SEN510C	SEN511C	SEN600C	SEN602C
Length	215 mm	188 mm	187 mm	205 mm
Width	42 mm	42 mm	42 mm	42 mm
Height	137 mm	137 mm	137 mm	137 mm
Weight	1,3 kg	1,1 kg	0,9 kg	1,1 kg
Torque	10,8 Nm	5,1 Nm	5,7 Nm	14,7 Nm
Speed (RPM)	800	1800	1800	800
Air inlet	1/4" NPT	1/4" NPT	1/4" NPT	1/4" NPT
Operating pressure	4,8-8,3 bar	4,8-8,3 bar	4,8-8,3 bar	4,8-8,3 bar
Air consumption	226 l/min	212 l/min	424 l/min	453 l/min
Torque control	-	-	Direct	Direct
Start	-	-	Direct	Direct
Warranty	1 yr	1 yr	1 yr	1 yr
APPLICATIONS	Drilling	Drilling	For screwdriving where torque is not critical	For screwdriving where torque is not critical

SEN610C

PNEUMATIC SCREWDRIVER

ITEM SEN610C



Features

- Composite housing
- Low noise - 83 dB(A)
- Adjustable torque
- Push-in start
- Low maintenance cost

SEN611C

PNEUMATIC SCREWDRIVER

ITEM SEN611C



Features

- Composite housing
- Low noise - 83 dB(A)
- Adjustable torque
- Push-in start
- Low maintenance cost

SEN612C

PNEUMATIC SCREWDRIVER

ITEM SEN612C



Features

- Composite housing
- Low noise - 83 dB(A)
- Reversible motor
- Low maintenance cost

SEN700C

PNEUMATIC IMPACT DRIVER

ITEM SEN700C



Features

- Composite housing
- Twin-hammer mechanism provides more power
- Feather trigger for precise speed control
- Left and right turning
- Energy efficient motor

Product Reference Chart

TOOL SPECS	SEN610C	SEN611C	SEN612C	SEN700C
Length	210 mm	230 mm	202 mm	164 mm
Width	42 mm	42 mm	43 mm	48 mm
Height	137 mm	137 mm	137 mm	168 mm
Weight	1,1 kg	1,2 kg	1,2 kg	0,98 kg
Torque	1,0-10,0 Nm	3,0-13 Nm	10,0 Nm	325 Nm
Speed (RPM)	1800	800	800	8900
Air inlet	1/4" NPT	1/4" NPT	1/4" NPT	1/4" NPT
Operating pressure	4,8-8,3 bar	4,8-8,3 bar	4,8-8,3 bar	6,2 bar
Air consumption	424 l/min	453 l/min	453 l/min	96 l/min
Torque control	Adjustable	Adjustable	Direct	Adjustable
Start	Push-in	Push-in	Push-in	Push-in
Warranty	1 yr	1 yr	1 yr	1 yr
APPLICATIONS	Screwdriving with adjustable torque	Screwdriving with adjustable torque	For screwdriving where torque is not critical	Screwdriving application that need high torque

Pneumatic Power

Whether you need an air compressor for quick jobs or for all-day performance, SENCO offers high quality, reliable options to meet your needs.

The most popular compressor is SENCO's iconic PC1010N portable finish and trim air compressor. Powerful, but also ultra-quiet and lightweight, the PC1010N features an oil-free pump design, integrated control panel and rugged roll cage. A full line of hoses and accessories is available for all compressors.

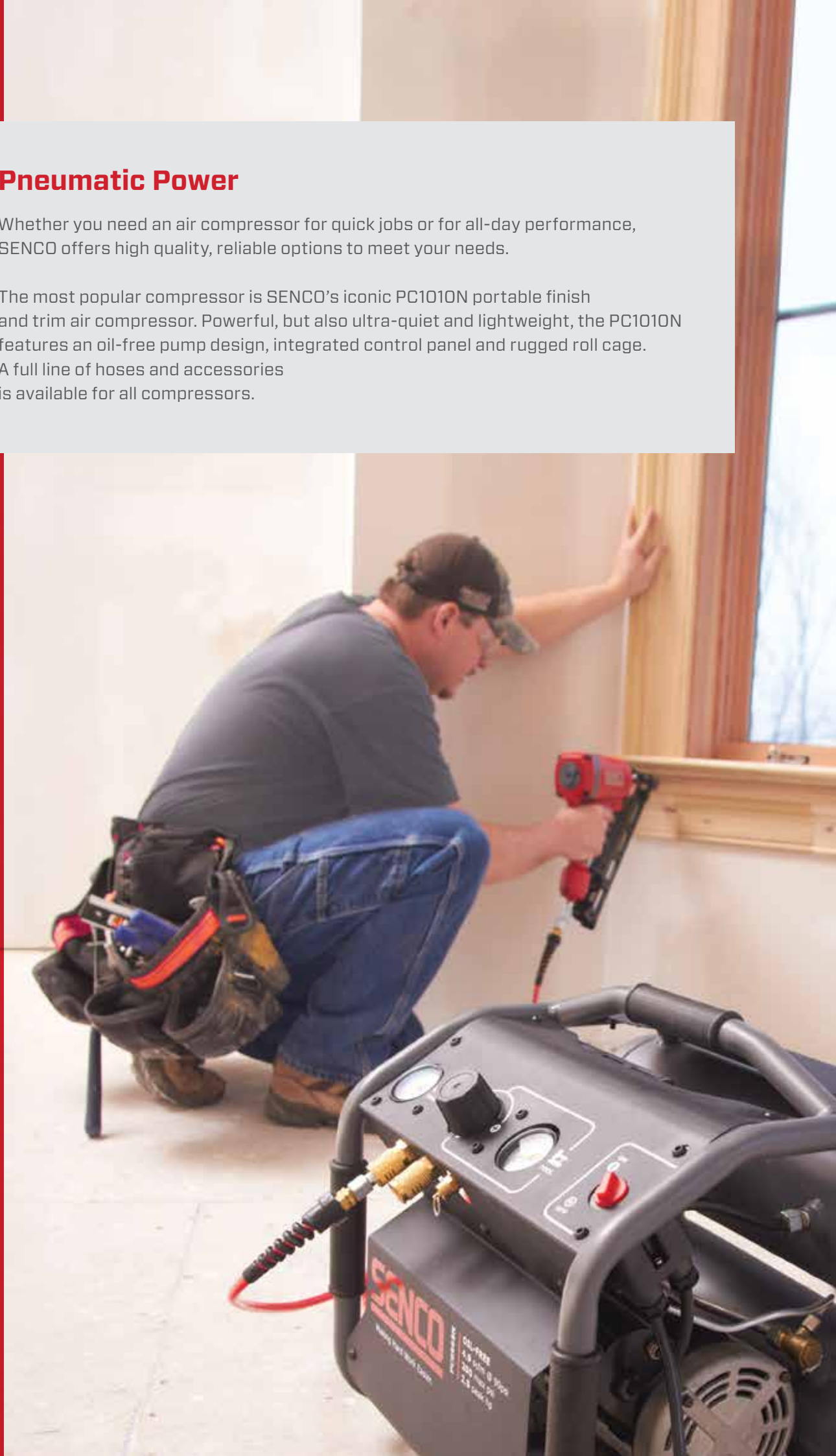

IN THE SPOTLIGHT



PC1010

number 1 mini-compressor worldwide

- 3000 life cycles
- quiet
- light weight

MAKING HARD WORK EASIER

COMPRESSORS

	Maxi
PC2225	96
PC1251	96
PC1246	96
	Midi
PC1252	97
PC1249	97
PC1250	97
	Mini
PC1010	98
PC1010N	98
PC1248	98
PC0968	98

SYSTAINER

Compressor PCS1290	100
Compressor Kit PC1010	100
3 in 1 set	100

STARTER KITS

PC1010/SLS18Mg	101
PC1010/FIP18Mg	101

	Motor (KW)	Oil less	Tank (l)	Finish	Trim	Upholstery	Roofing	Siding	Sheating	Framing	Decking	Subfloors	Packaging
PC1010	0,3	•	3,8	•	•	•							
PC1010N	0,3	•	3,8	•	•	•							
PCS1290	0,5	•	4	•	•	•							
PC1248	1,1	•	8	•	•	•	•	•					
PC0968	1,1	•	10	•	•	•	•	•					
PC1252	1,5		3	•	•	•	•	•	•				
PC1249	1,5		10	•	•	•	•	•	•	•	•	•	•
PC1250	1,5	•	46	•	•	•	•	•	•	•	•	•	•
PC2225	1,9		16	•	•	•	•	•	•	•	•	•	•
PC1251	1,9		20	•	•	•	•	•	•	•	•	•	•
PC1246	2,6		16	•	•	•	•	•	•	•	•	•	•



PC2225

MAXI COMPRESSOR

ITEM PC2225EU (230V)



Features

- Big wheels, stable and easy to move
- Die cast aluminium
- Compact design and strong frame
- Pump with cast iron sleeve

PC1251

MAXI COMPRESSOR

ITEM PC1251EU (230V), PC1251UK1 (110V)



Features

- Sturdy mobile compressor
- Thermal overload protection
- Fully automated control
- Large non-inflatable rubber wheels

PC1246

MAXI COMPRESSOR

ITEM PC1246EU (230V), PC1246UK1 (110V)
PC1246UK2 (230V)



Features

- Oil free
- Light weight, easy to move
- Dual safety valves
- Thermal overload protection

Product Reference Chart

SPECS	PC2225	PC1251	PC1246
Length	650 mm	550 mm	650 mm
Width	560 mm	520 mm	530 mm
Height	530 mm	760 mm	850 mm
Weight	39 kg	37,5 kg	57 kg
Power	230V / 1,9 kW (2,5 hp)	230V / 1,9 kW (2,5 hp)	230V / 2,6 kW (3,5 hp)
RPM	2850	2850	2850
Tank capacity	16,0 l	20,0 l	16,0 l
Maximum pressure	9 bar	9 bar	10 bar
Displacement	268 l/min	271 l/min	350 l/min
Airflow (6-6,2 bar)	192 l/min	164 l/min	224 l/min
Noise level	82 db(A)	83 db(A)	89 db(A)
Warranty	1 yr	1 yr	1 yr
APPLICATIONS	Finish, trim, roofing, siding, decking, subflooring, sheathing, pallets, framing, packaging	Finish, trim, upholstery, roofing, siding, decking, subflooring, sheathing, pallets and framing	Finish, trim, roofing, siding, decking, subflooring, sheathing, pallets and framing

PC1252

MIDI COMPRESSOR

ITEM PC1252EU (230V)



Features

- Hand carry
- Sturdy, very compact and mobile
- Pressure switch with start-up valve
- Fully automated control
- Excellent for pneumatic caulk guns

PC1250

MIDI COMPRESSOR

ITEM PC1250EU (230V), PC1250UK1 (110V)



Features

- Sturdy, high performance compressor
- Thermal overload protection
- Fully automated control
- Oil free

PC1249

MIDI COMPRESSOR

ITEM PC1249EU (230V)



Features

- Sturdy mobile compressor
- Thermal overload protection
- Pressure regulator for controlled working pressure

PCS1290

Improving convenience of transport and storage



Cordless convenience even below 0°C

More information about our Fusion technology on page...



Product Reference Chart

SPECS	PC1252	PC1249	PC1250
Length	540 mm	320 mm	880 mm
Width	310 mm	360 mm	320 mm
Height	430 mm	660 mm	670 mm
Weight	23 kg	30 kg	42 kg
Power	230V / 1,5 kW (2 hp)	230V / 1,5 kW (2 hp)	230V / 1,5 kW (2 hp)
RPM	2850	2850	2850
Tank capacity	3,0 l	10,0 l	46,0 l
Maximum pressure	9 bar	9 bar	10 bar
Displacement	201 l/min	201 l/min	277 l/min
Airflow (6-6,2 bar)	122 l/min	133 l/min	164 l/min
Noise level	84 db(A)	93 db(A)	87 db(A)
Warranty	1 yr	1 yr	1 yr
APPLICATIONS	Finish, trim, roofing, siding, decking, subflooring, sheathing and framing	Finish, trim, upholstery, roofing, siding, decking, subflooring, sheathing, pallets and framing	Finish, trim, roofing, siding, decking, subflooring, sheathing, pallets, framing, packaging

PC1010

MINI COMPRESSOR

ITEM PC1010EU (230V), PC1010UK1 (110V)
PC1010UK2 (230V)



Features

- Oil free
- Ultra light, 9,1kg
- Ultra quiet, 68 dBA
- Heavy duty induction motor (3.000 working hours)

PC1010N

MINI COMPRESSOR

ITEM PC1010NEU (230V)



Features

- Oil free
- Ultra light, 9,7kg
- Ultra quiet, 68 dBA
- Heavy duty induction motor (3.000 working hours)

PC1248

MINI COMPRESSOR

ITEM PC1248EU (230V), PC1248UK1 (110V)
PC1248UK2 (230V)



Features

- Oil free
- Sturdy, lightweight
- Thermal overload protection
- Fully automated control

PC0968

MINI COMPRESSOR

ITEM PC0968EU (230V)



Features

- Compact twin stacked design
- Heavy duty induction motor
- Cold start valve, easy start-up under cold conditions
- Oil free
- Silent, 81 dBA

Product Reference Chart

SPECS	PC1010	PC1010N	PC1248	PC0968
Length	360 mm	365 mm	160 mm	400 mm
Width	330 mm	300 mm	490 mm	380 mm
Height	250 mm	310 mm	460 mm	340 mm
Weight	9,1 kg	9,7 kg	16,8 kg	17 kg
Power	230V / 0,3kW (0,5 hp)	230V / 0,3kW (0,5 hp)	230V / 1,1 kW (1,5 hp)	230V / 1,1 kW (1,5 hp)
RPM	2850	2850	2850	2850
Tank capacity	3,8 l	3,8 l	8,0 l	10,0 l
Maximum pressure	8 bar	9 bar	9 bar	9 bar
Displacement	34 l/min	34 l/min	139 l/min	113 l/min
Airflow (6-6,2 bar)	20 l/min	20 l/min	79 l/min	51 l/min
Noise level	68 db(A)	68 db(A)	83 db(A)	81 db(A)
Warranty	1 yr	1 yr	1 yr	1 yr
APPLICATIONS	Primarily finish, trim and upholstery	Upholstery, finish and trim	Finish, trim, upholstery, roofing, siding and sheathing	Finish, trim, upholstery, roofing and siding

Get the Job Done.

With genuine SENCO compressors & accessories.

SENCO continuously strives to offer a wide selection of compressors, accessories, and parts to complete our full-line of fastening systems. Our commitment is to bring you the highest quality products to help you get the job done.



COMPRESSORS

SENCO compressors are made to exacting standards specified by SENCO. Only the highest quality components are used to provide the reliability expected from a SENCO product.

AIR HOSES

SENCO offers a wide variety of air hoses that allow you to choose the right solution for your job site. Our NEW Premium Hybrid hose provides the ultimate in flexibility and memory resistance, even in extremely cold temperatures. Quick Couple Rubber Hose is the standard for the professional on the job site with its tough flexible neoprene cover. ProFlex Reinforced Polyurethane Hose is the lightest weight non-marring flexible hose. PVC is resistant to lubricating oils, chemicals, and ultraviolet sunlight.



FILTERS, REGULATORS, GAUGES & LUBRICANTS

SENCO's assortments of filters, regulators, gauges, oils and lubricants are chosen to satisfy the demanding requirements of the job site and deliver professional durability and quality. All will accurately replace the damaged component on SENCO units as well as many others.

PLUGS & COUPLERS

SENCO quick connect coupler and plug fittings are available in the most popular Industrial Interchange styles and sizes. Quick connect couplers are also available in the Universal style to work with other style plugs.



PCS1290
MINI COMPRESSOR
ITEM PCS1290 (230V)



- Features**
- Easy to transport
 - Front panel access

3 IN 1 SET
FiP18MG, FiP35MG, SLS18MG-L
ITEM 3PR2012N



- Features**
- Easy to transport
 - Fits on every T-loc systainer
 - Protects tools

COMPRESSOR KIT PC1010
MINI COMPRESSOR
ITEM 3PR2014N (230V), 3PR2014N-UK (110V)



- Features**
- Hand carry-ultra quiet
 - Lightweight
 - Direct drive motor/pump for efficient operation
 - Comfortable cushioned grip

**THE SYSTAINER®
NOT ONLY A CASE,
IT IS A WAY OF WORKING**



Product Reference Chart

SPECS	PCS1290	COMPRESSOR KIT PC1010	3 IN 1 SET
Length	396 mm	396 mm	396 mm
Width	296 mm	296 mm	296 mm
Height	315 mm	315 mm	315 mm
Weight	16,5 kg		
Power	230V / 0,5 kW (0,7 hp)	230V / 0,3kW (0,5 hp)	
RPM	2850		
Tank capacity	4,0 l		
Maximum pressure	8,6 bar		
Displacement	90 l/min	PC1010 page 98	
Airflow (6-6,2 bar)	46 l/min		
Noise level	88 db(A)		
Warranty	1 yr	1 yr	1 yr

FiP18Mg page 46
FiP35Mg page 46
SLS18Mg-L page 26

PC1010/SLS18Mg

STARTER KIT

ITEM PC0972EUPU (230V), PC0972UKPU1 (110V)



Contents

- PC1010 Compressor
- SLS18-L Mg Medium wire stapler
- Including Premium Hose
- Including safety glasses
- Including blisterpack L staples

PC1010/FinishPro18Mg

STARTER KIT

ITEM PC0964EUPU (230V), PC0964UKPU1 (110V)
PC0964UKPU2 (230V)



Contents

- PC1010 Compressor
- FinishPro18Mg Brad nailer
- Including Premium Hose
- Including safety glasses
- Including blisterpack AX brads

PC1010/SLS18Mg in Systainer

STARTER KIT IN SYSTAINER

ITEM PC0972EUPS (230V), PC0972UKPS1 (110V)



PC1010/FIP18Mg in Systainer

STARTER KIT IN SYSTAINER

ITEM PC0964EUPS (230V), PC0964UKPS1 (110V)
PC0964UKPS2 (230V)



Product Reference Chart

SPECS	PC1010/SLS18Mg	PC1010/FinishPro18Mg
	PC1010 page 98 SLS18Mg-L page 26	PC1010 page 98 FIP18Mg page 46

ACCESSORIES

FILTERS, REGULATORS, LUBRICANTS, PLUGS, COUPLERS, HOSES, PART KITS AND MORE

SENCO offers an assortment of accessories that are precision engineered to meet the demanding requirements of professionals. Be sure that your tools and compressors are running at peak performance by using SENCO certified replacement parts, accessories, hoses, oils and lubricants.



ACCESSORIES

AIR

Air accessory kit	104
Air blow gun	104

HOSES

Automatic winding hose reel	104
Hose reel/Premium hose reel	104
Spiral hose	104
Air hose kit/ Premium air hose kit	104
Air hose/Premium air hose	105
High pressure hose	105

PLUGS/COUPLERS



Plug 320 male	105
Plug 300 male	105
Plug 310 male	105
Hose plug	105
Plug 320 female	105
Hose repair plug	105
Hose clamp	106
Coupler male	106
Coupler female	106
Hose coupler	106

OTHERS

Teflon tape	106
Spring balancer	106
Lubricants	106
Compressor oil	106
Safety glasses	107
Staple remover	107
Service repair kit	107



Air

Air accessory kit		
Description	ITEM #	
Air accessory kit Washing pistol, tire inflating gun with pressure gauge, paint spray gun, air blow gun, hose	400050	

Airblow gun		
Description	ITEM #	
Airblow gun metal with Cejn coupling	400030	
Airblow gun metal with Orion coupling	400031	
Airblow gun blue with Orion coupling	400032	

Hoses



Automatic winding hose reel		
Description	ITEM #	
Hose reel universal auto PU 320 comp. 12m x 6,5mm	4000720	
Hose reel universal auto PU 320 comp. 10m x 8,0mm	4000721	

Hose reel/Premium hose reel		
Description	ITEM #	
Hose reel universal PU 320 comp. 30m x 8mm	4000730	
Hose reel premium hybrid PVC 320 comp. 30m x 10mm	4000731	

Spiral hose		
Description	ITEM #	
Kit universal PU 320 comp. 6m x 6,5mm (i.d.)	4000600	
Kit universal PU 320 comp. 6m x 8mm (i.d.)	4000610	
Kit universal PU 320 comp. 6m x 10mm (i.d.)	4000620	

Air hose kit/ Premium air hose kit		
Description	ITEM #	
Kit universal PU 320 comp. 10m x 6,5mm (i.d.)	4000650	
Kit universal PU 320 comp. 10m x 8mm (i.d.)	4000660	
Kit universal PU 320 comp. 10m x 10mm (i.d.)	4000670	
Kit premium PVC 320 comp. 10m x 6,5mm (i.d.)	4000651	
Kit premium PVC 320 comp. 10m x 10mm (i.d.)	4000671	
Kit premium PVC 310 comp. 10m x 10mm (i.d.)	4000661	

ACCESSORIES

Air hose/Premium air hose		
Description	ITEM #	
PU 50m x 6,5mm (i.d.)	4000680	
PU 50m x 8mm (i.d.)	4000690	
PU 50m x 10mm (i.d.)	4000700	
PU 150m x 6,5mm (i.d.)	4000681	
PU 150m x 8mm (i.d.)	4000691	
PU 150m x 10mm (i.d.)	4000701	
Premium hybrid PVC 50m x 6,5mm (i.d.)	4000682	
Premium hybrid PVC 50m x 8mm (i.d.)	4000692	
Premium hybrid PVC 50m x 10mm (i.d.)	4000702	
Premium hybrid PVC 150m x 6,5mm (i.d.)	4000683	
Premium hybrid PVC 150m x 10mm (i.d.)	4000703	

High pressure hose		
Description	ITEM #	
High pressure hose 15m	960400	

Plugs/Couplers

Plug 320 male		
Description	ITEM #	
Universal 320 comp. NPT 1/4" 2 pcs.	4000100	
Universal 320 comp. NPT 3/8" 2 pcs.	4000110	
Universal 320 comp. NPT 1/2" 2 pcs.	4000120	
Universal 320 comp. NPT 1/4" 10 pcs.	4000101	
Universal 320 comp. NPT 3/8" 10 pcs.	4000111	

Plug 300 male		
Description	ITEM #	
Plug 300 comp. NPT 1/4" 2 pcs.	4000060	
Plug 300 comp. NPT 1/4" 10 pcs.	4000061	
Plug 300 comp. NPT 1/4" 1000 pcs.	4000062	
Plug 300 comp. NPT 3/8" 2 pcs.	4000070	
Plug 300 comp. NPT 3/8" 10 pcs.	4000071	
Plug 300 comp. NPT 3/8" 1000 pcs.	4000072	

Plug 310 male		
Description	ITEM #	
Plug 310 comp. NPT 1/4" 2 pcs.	4000080	
Plug 310 comp. NPT 1/4" 10 pcs.	4000081	
Plug 310 comp. NPT 1/4" 1000 pcs.	4000082	
Plug 310 comp. NPT 3/8" 2 pcs.	4000090	
Plug 310 comp. NPT 3/8" 10 pcs.	4000091	
Plug 310 comp. NPT 3/8" 1000 pcs.	4000092	

Hose plug		
Description	ITEM #	
Universal hose 320 comp. 6,5mm blist. 2 pcs.	4000200	
Universal hose 320 comp. 8mm blist. 2 pcs.	4000210	
Universal hose 320 comp. 10mm blist. 2 pcs.	4000220	
Universal hose 320 comp. 12,7mm blist. 2 pcs.	4000230	
Universal hose 310 comp. 8mm blist. 2 pcs.	4000211	

Plug 320 female		
Description	ITEM #	
Universal 320 comp. NPT 1/4" 2 pcs.	4000150	
Universal 320 comp. NPT 3/8" 2 pcs.	4000160	
Universal 320 comp. NPT 1/2" 2 pcs.	4000170	
Universal 320 comp. NPT 1/4" 10 pcs.	4000151	
Universal 320 comp. NPT 3/8" 10 pcs.	4000161	

Hose repair plug		
Description	ITEM #	
6mm blist. 2 pcs.	4000480	
8mm blist. 2 pcs.	4000490	
9,5mm blist. 2 pcs.	4000500	

Hose clamp		
Description	ITEM #	
10-16mm blist. 5 pcs.	4000520	

Coupler male		
Description	ITEM #	
Universal 320 comp. NPT 1/4" blist. 1 pcs.	4000300	
Universal 320 comp. NPT 3/8" blist. 1 pcs.	4000310	
Universal 320 comp. NPT 1/2" blist. 1 pcs.	4000320	
Universal 310 comp. NPT 1/4" blist. 1 pcs.	4000302	
Universal 310 comp. NPT 3/8" blist. 1 pcs.	4000312	

Coupler female		
Description	ITEM #	
Universal 320 comp. NPT 1/4" blist. 1 pcs.	4000370	
Universal 320 comp. NPT 3/8" blist. 1 pcs.	4000380	
Universal 320 comp. NPT 1/2" blist. 1 pcs.	4000390	
Universal 310 comp. NPT 1/4" blist. 1 pcs.	4000372	
Universal 310 comp. NPT 3/8" blist. 1 pcs.	4000382	

Hose coupler		
Description	ITEM #	
Universal 320 comp. 6,5mm blist. 1 pcs.	4000400	
Universal 320 comp. 8mm blist. 1 pcs.	4000410	
Universal 320 comp. 10mm blist. 1 pcs.	4000420	
Universal 320 comp. 12,7mm blist. 1 pcs.	4000430	
Universal 310 comp. 8mm blist. 1 pcs.	4000412	

Compatibility matrix	SENCO 300 Series	SENCO 310 Series	SENCO 320 Series
ARO 210	X		
ATLAS COPCO QIC8		X	
CEJN 300	X		
CEJN 310		X	
CEJN 320			X
FOSTER 3003		X	
GROMMELLE 600		X	
HANSEN 210	X		
HANSEN 3000		X	
HANSEN AUTO-FLO 24			X
JWL520			X
JWL521		X	
JWL531		X	
JWL532	X		
JWL552	X		
OETIKER B1		X	
OETIKER SC C			X
ORION 44510	X		
ORION 44515	X		





Compatibility matrix	SENCO 300 Series	SENCO 310 Series	SENCO 320 Series
PARKER 20 1/4"		X	
PARKER 30 1/4"		X	
PARKER 50	X		
PREVOST ASI06	X		
PREVOST ERC07			X
PREVOST ESC07			X
PREVOST ESI07			X
PREVOST ESI08			X
PREVOST ISCO6		X	
PREVOST ISIO6		X	
RECTUS 14	X		
RECTUS 22	X		
RECTUS 23		X	
RECTUS 24		X	
RECTUS 25			X
RECTUS 26			X
TEMA 1400		X	
TEMA 1423		X	
TEMA 1600			X
TEMA 1625			X



Others



Teflon tape		
Description	ITEM #	
10m blist. 1 pcs.	4000540	

Spring balancer		
Description	ITEM #	
Spring balancer cap. 1,5-3,0 kg.	4001000	
Spring balancer cap. 3,0-5,0 kg.	4001001	

Compressor oil		
Description	ITEM #	
Compressor oil 945 ml	PC0344	

Lubricants		
Description	ITEM #	
Machine lubricant 115 g	YB0123	
Premium machine oil, moisture-resistant 945 ml	PC1295	
Machine oil for staplers 235 ml	PC0101	
Machine oil for staplers 945 ml	PC0102	

Safety glasses		
Description	ITEM #	
Senco safety glasses CE	PC1166	
Senco safety glasses, tinted CE	PC1167	

Staple remover		
Description	ITEM #	
Senco staple remover	960037	
Spare blade Senco staple remover	960038	

















Service repair kits	
Description	ITEM #
Firing/Trigger system kit SNS45XP	YK0230
Piston stop kit SNS45XP	YK0231
Firing system/trigger kit FrameProXP	YK0243
Piston stop kit FrameProXP	YK0244
Piston stop kit FinishPro25XP	YK0282
Piston stop kit SLS25XP	YK0291
Seal kit FramePro652	YK0353
Firing/trigger system kit SLS25XP	YK0359
Repair kit FramePro601/602/651/652	YK0360
Firing/Trigger system kit FiP41XP/42	YK0361
Repair kit FinishPro35	YK0365
Repair kit SCN60/65N	YK0366
Repair kit SFN40	YK0367
Repair kit SFN30	YK0368
Repair kit SFN40R	YK0369
Repair kit SLS20	YK0372
Repair kit SLP20	YK0373
Repair kit SNS40	YK0374
Repair kit SNS50XP/SQS55XP	YK0375
Repair kit SFN1, SKS, SPS	YK0376
Repair kit PW 2"	YK0378
Repair kit SLS15/18 FiP15/18/2N1	YK0393
Repair kit FiP10 new main body	YK0397

Service repair kits	
Description	ITEM #
Repair kit PW150-200	YK0402
T-Driver kit SCN90CXP	YK0414
Piston/driver kit FramePro702XP	YK0418
Firing/trigger system kit SNS44XP	YK0421
Piston stop kit SNS44XP	YK0422
Repair kit RP450	YK0426
Firing system kit SN901XP/902951XP/952	YK0444EU
Piston stop kit SN901XP/902 SN951XP/952	YK0445EU
Repair kit PAL57	YK0446
Repair kit PAL70	YK0447
Piston stop kit SN951XP/952XP	YK0768EU
Repair kit SCN48	YK0769
Repair kit SCN75	YK0770
Repair kit SCN49	YK0771
Repair kit PAL50	YK0772
Repair kit PAL90	YK0774
Repair kit SFW09-C	YK0775EU
Repair kit PAL83	YK0779
Repair kit FinishPro18Mg	YK0780
Repair kit WC150XP/WC200XP	YK0783EU
Repair kit WC150XP/WC200XP	YK0784EU
Repair kit SCN34	YK0785
Repair kit SN1302	YK0789EU

Service repair kits	
Description	ITEM #
Repair kit SC15	YK0790EU
Driver/back plate upgrade kit SNS44	YK0793
Driver/back plate upgrade kit SNS41	YK0794
Drive assembly Fusion FN65DA	YK0798EU
Cylinder assembly Fusion FN55AX	YK0799EU
Drive assembly Fusion FN65RHS	YK0801EU
Repair kit SFT10XP	YK0802EU
Repair kit SFT10XP	YK0803EU
Repair kit SFT10XP	YK0804EU
Cap assembly upgraded WC150XP	YK0818
Drive assembly Fusion FN65RHA	YK0822EU
Long Magazine kit SGP40-S	YK0837EU
Trigger valve system kit SHS51XP	YK0838EU
Piston stop kit SHS51XP	YK0839EU
Trigger valve system kit SHS50XP	YK0840EU
Piston stop kit SHS50XP	YK0841EU



FINISH & WOODWORKING

SLS20XP MEDIUM WIRE STAPLER	SLS25XP MEDIUM WIRE STAPLER	SLS18Mg MEDIUM WIRE STAPLER	SMS92 MEDIUM WIRE STAPLER	SKSXP MEDIUM WIRE STAPLER	FinishPro10 MICROPINNER 0,6MM
					
Pg. 23	Pg. 23	Pg. 26	Pg. 26	Pg. 23	Pg. 46
LS1XP HEADLESS BRAD NAILER	SBN10XP BRAD NAILER 1,2MM	SLP20XP BRAD NAILER 1,2MM	SLP20XP GLN BRAD NAILER 1,2MM	FinishPro18Mg BRAD NAILER 1,2MM	FinishPro25XP BRAD NAILER 1,2MM
					
Pg. 44	Pg. 44	Pg. 44	Pg. 44	Pg. 46	Pg. 45
FinishPro32 BRAD NAILER 1,6MM	FinishPro42XP FINISH NAILER	FinishPro35Mg FINISH NAILER	FinishPro30XP FINISH NAILER	FinishPro®23SXP 1½" HEADLESS PINNER	FinishPro®23LXP 2" HEADLESS PINNER
					
Pg. 46	Pg. 45	Pg. 46	Pg. 45	Pg. 43	Pg. 43
FinishPro®21LXP 2" PINNER	S150MS MEDIUM WIRE STAPLER	S200BN BRAD NAILER	S200SM BRAD NAILER	S250FN BRAD NAILER	
					
Pg. 43	Pg. 28	Pg. 47	Pg. 47	Pg. 47	

FRAMING, SHEATING & SUBFLOORS

SHS50XP HEAVY WIRE STAPLER	SNS41 HEAVY WIRE STAPLER	SQS55XP HEAVY WIRE STAPLER	WC150XP WIDE CROWN STAPLER	WC200XP WIDE CROWN STAPLER	WC330-SP WIDE CROWN STAPLER
					
Pg. 24	Pg. 27	Pg. 24	Pg. 25	Pg. 25	Pg. 27
WC330-SP WIDE CROWN STAPLER	SN90CXP CLIPPED HEAD NAILER	SN90FXP FULL ROUND HEAD NAILER	FramePro601 CLIPPED HEAD NAILER	FramePro651 CLIPPED HEAD NAILER	SN1302 FULL ROUND HEAD NAILER
					
Pg. 27	Pg. 38	Pg. 38	Pg. 39	Pg. 39	Pg. 40

REFERENCE

SN1602 FULL ROUND HEAD NAILER	SAP40XP CONCRETE NAILER	MC60-34 METAL CONNECTOR	SCN65XP COILNAILER	CoilPRO90 COILNAILER	A20 PALM HAND NAILER
					
Pg. 40	Pg. 17	Pg. 40	Pg. 60	Pg. 62	Pg. 88
S900FN CH FRAMING NAILER					
					
Pg. 41					

PALLETS, CRATING & PACKAGING

DFPXP PLIER TOOL	F75LXP PLIER TOOL	F75SXP PLIER TOOL	FAT25 PLIER TOOL	COILPRO32 COILNAILER	COILPRO50 COILNAILER
					
Pg. 86	Pg. 86	Pg. 86	Pg. 86	Pg. 61	Pg. 61
PAL57F COILNAILER	PAL70 COILNAILER	PAL70 DUPLEX COILNAILER	PAL83 COILNAILER	PAL90 COILNAILER	PAL100 COILNAILER
					
Pg. 65	Pg. 65	Pg. 65	Pg. 66	Pg. 66	Pg. 66
PAL100 EPAL COILNAILER	PAL130 COILNAILER	EPAL MARKING NAIL COILNAILER	SCN34 COILNAILER		
					
Pg. 66	Pg. 67	Pg. 67	Pg. 61		

ROOFING & SIDING

BC58 BUTTON CAP STAPLER	ROOFPRO455XP COILNAILER	SCN49XP COILNAILER	SCN650 COILNAILER	SCN75 COILNAILER	SIDINGPRO40 CLIPPED HEAD NAILER
					
Pg. 88	Pg. 60	Pg. 60	Pg. 62	Pg. 62	Pg. 39
TPR065 T-NAILER	SHT-F HAMMERTACKER	S45CNR ROOFING COILNAILER	S65CNP COILNAILER		
					
Pg. 87	Pg. 88	Pg. 63	Pg. 63		

UPHOLSTERY & FURNITURE

SFT10XP LIGHT WIRE STAPLER	SFT10XP-DL LIGHT WIRE STAPLER	SFT10XP-LN LIGHT WIRE STAPLER	SFW09 LIGHT WIRE STAPLER	SHS51XP HEAVY WIRE STAPLER	SC15 CORRUGATED FASTENER
					
Pg. 22	Pg. 22	Pg. 22	Pg. 26	Pg. 24	Pg. 87
SCN30 COILNAILER	SFW05 LIGHT WIRE STAPLER	S150LS MEDIUM WIRE STAPLER			
					
Pg. 61	Pg. 28	Pg. 28			

COMPRESSORS





PC0968 MINI COMPRESSOR	PC1010 MINI COMPRESSOR	PC1010N MINI COMPRESSOR	PC1248 MINI COMPRESSOR	COMPRESSOR KIT PC1010 MINI COMPRESSOR	PCS1290 MINI COMPRESSOR
					
Pg. 98	Pg. 98	Pg. 98	Pg. 98	Pg. 100	Pg. 100
PC1249 MIDI COMPRESSOR	PC1250 MIDI COMPRESSOR	PC1252 MIDI COMPRESSOR	PC1246 MAXI COMPRESSOR	PC1251 MAXI COMPRESSOR	PC2225 MAXI COMPRESSOR
					
Pg. 97	Pg. 97	Pg. 97	Pg. 96	Pg. 96	Pg. 96

REFERENCE



DRILLS & SCREWDRIVERS

DS5525-18V HEAVY DUTY MACHINE	DS5525-AC HEAVY DUTY MACHINE	DS5550-18V HIGH SPEED MACHINE	DS5550-AC HIGH SPEED MACHINE	DS7525-18V MULTI PURPOSE MACHINE	DS7525-AC MULTI PURPOSE MACHINE
					
Pg. 8	Pg.9	Pg. 8	Pg. 9	Pg. 8	Pg. 9
ATTACHMENT DS50 SCREW FASTENING	ATTACHMENT DS75 SCREW FASTENING	SEN510C PNEUMATIC DRILL	SEN511C PNEUMATIC DRILL	SEN600C PNEUMATIC SCREWDRIVER	SEN602C PNEUMATIC SCREWDRIVER
					
Pg. 14	Pg. 14	Pg. 92	Pg.92	Pg. 92	Pg. 92
SEN610C PNEUMATIC SCREWDRIVER	SEN611C PNEUMATIC SCREWDRIVER	SEN612C PNEUMATIC SCREWDRIVER	SEN700C PNEUMATIC IMPACT DRIVER		
					
Pg. 93	Pg. 93	Pg. 93	Pg.93		

FUSION

FUSION F-15 FINISH NAILER 1,8MM	FUSION F-16A FINISH NAILER 1,6MM	FUSION F-16S FINISH NAILER 1,6MM	FUSION F-18 BRAD NAILER 1,2MM
			
Pg. 5	Pg. 5	Pg. 5	Pg.5

GAS TECHNOLOGY

GT35HN HAFTEN NAILER	GT50AX BRAD NAILER 1,2MM	GT60NN METAL CONNECTOR	GT65DA FINISH NAILER 1,8MM	GT65RHA FINISH NAILER 1,6MM	GT65RHS FINISH NAILER 1,6MM
					
Pg. 48	Pg. 49	Pg. 48	Pg. 49	Pg. 49	Pg. 49
GT90CH CH FRAMING NAILER	GT90FRH FRH FRAMING NAILER	SGP40S CONCRETE NAILER	GT40FS CORDLESS FENCING STAPLER		
					
Pg. 48	Pg. 48	Pg. 17	Pg. 87		

**Contact Us**

KYOCERA SENCO UK Ltd.
630 Europa Boulevard
Warrington WA5 7YH
United Kingdom

T: +44 192 544 5566
E: sales@kyocera-senco.co.uk

**Visit Us**

On the web for more information
SENCO.eu

**Find Us**

Use our local dealer locator to find your closest
SENCO dealer on SENCO.eu

**Watch Us**

Check out all of our latest videos & product launches on
YouTube at [Kyocera Senco EMEA](https://www.youtube.com/KyoceraSencoEMEA)

**Follow Us**

On Facebook for the latest SENCO news
 [SENCO EMEA](https://www.facebook.com/SENCOEMEA)