



AIR DIFFUSION

LYRA

LYRA

» ENERGY EFFICIENT
CASSETTE CHILLED BEAM



Energy efficiency – the essence of our solutions

All our research, development and testing activities are singularly focused to provide our customers with the best and most efficient solutions possible to their ventilation and indoor climate challenges.

From new and innovative concepts, smart material choices and manufacturing processes to advanced controls, minimised running cost and easy maintenance, FläktGroup always strive to deliver the best for your long-term economy and our environment.



LYRA CASSETTE CHILLED BEAM HIGH COMFORT SOLUTION WITH GREAT FLEXIBILITY AND PERFORMANCE

The indoor climate influences comfort, well being and therefore efficiency of occupants. An efficient HVAC system should deliver the optimal air quality – temperature, humidity and the right level of fresh air. It should also be designed for draught free diffusion with low noise levels. Another request from new building owners is for installation flexibility. A building will change configurations many times during its life-time and a modern HVAC system must be able to adapt to different layouts.

LYRA is the right choice for modern buildings requiring high comfort, low energy consumption and flexibility. With three main functions: ventilation, cooling and heating, LYRA will supply the right indoor climate for applications like offices, schools, hospitals and retail developments.



KEY PRODUCT BENEFITS

- **LOW NOISE LEVEL**
LYRA offers very low noise levels. In a room with 1 LYRA and normal airflow, the noise level is below 20 dB. In a room with 2 LYRA installed, it will be below 30 dB – less than the ambient noise in a quiet office.
- **COMFORT**
The mixing of supply air with ambient air coupled with the coanda effect gives optimal room comfort.
- **HIGH COOLING CAPACITY**
LYRA diffuses air in 4 directions. This feature gives a high cooling capacity whilst delivering a high level of comfort.
- **COMPACT DIMENSIONS AND EASY INSTALLATION**
With the 4-way diffusion, LYRA takes up less ceiling space compared to linear units. Thanks to its compact dimensions and 'Snap in' brackets, the installation is very easy to perform.

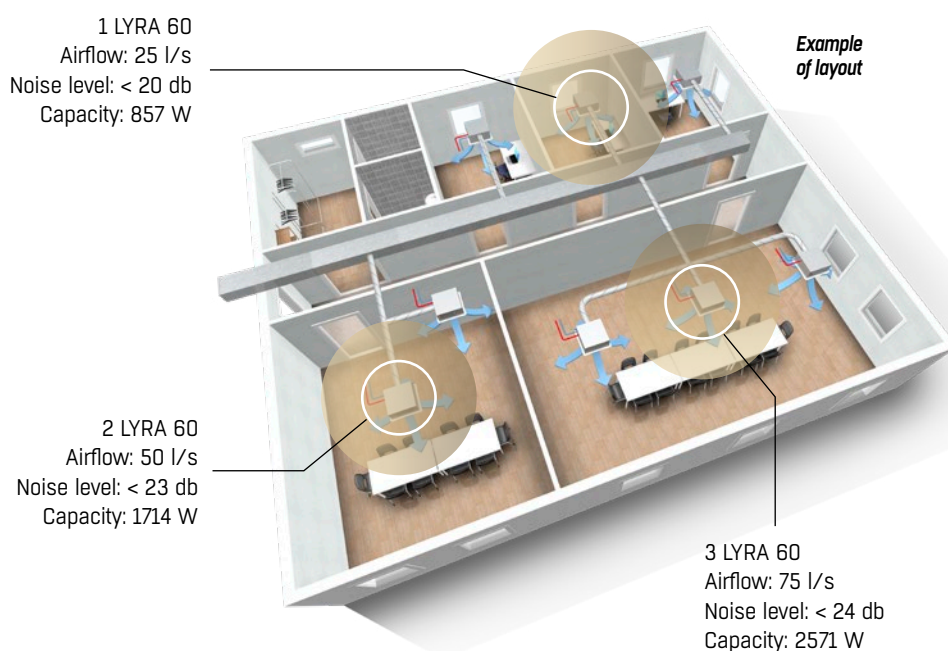

Flexibility and comfort for modern building requirements

LYRA's flexibility and large variety of functions make it possible to change the office layout without the need to move the chilled beams. Refurbishing, adding or removing internal walls can be done without decreasing the indoor air quality and comfort, which is perfect to keep up with the constant changes in modern business.

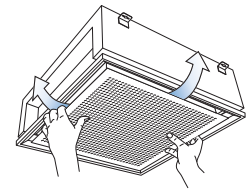

COANDA SAFETY CONTROL FUNCTION

Coanda Safety Control (CSC) maintains the Coanda effect (adhesion of the air to the ceiling) whilst achieving the highest possible cooling power. The position of the front panel ensures a good air diffusion whatever the airflow.



COMFORT CONTROL FUNCTION

The adjustable induction system fits the performance needs and enables 1 to 4 diffusion directions.

- Symmetric or dissymmetric airflow
- Possible to change at any time
- No tools required

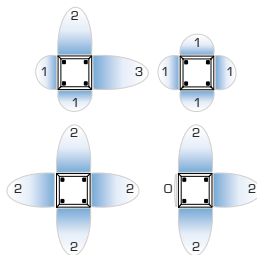

FLOW PATTERN CONTROL FUNCTION

The adjustable plastic blades enable optimized air diffusion

- No tools required
- Possibility to adjust the throw length accordingly to room layout

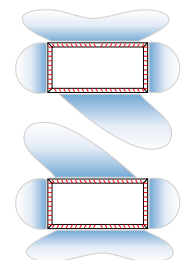

3 VERSIONS AVAILABLE



Ceiling installation, available in 600 x 600 and 1200 x 600 mm

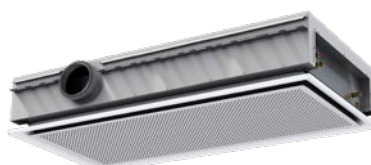

High flow version, available in 1200 x 600 mm



Exposed installation, available in 700 x 700 and 1300 x 700 mm

EASY INSTALLATION

With the fastening brackets, the installation of LYRA is quick, safe and easy. The system is installed in two steps:

- The rods and brackets in a first step.
- The beam itself when the building is clean.

Only 1 person is needed to install LYRA.

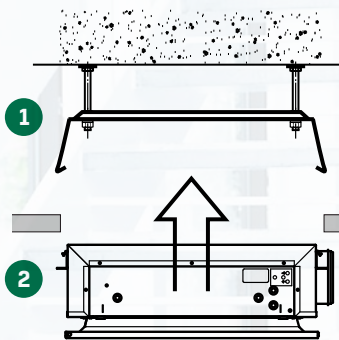

Always the perfect setting with FläktGroup integrated controls

LYRA is available with integrated control. The room controller can be positioned in three different locations depending on the desired level of accessibility. Room controller, actuators, condensation and temperature sensors are mounted on the chilled beam and wired to make the installation quick and easy. Simply connect LYRA to 24V AC and you are ready!



Room controller located on the wall – accessible for changes at any time.



Room controller located on the front plate – easy access from the room.



Room controller located on the side of LYRA – accessible by removing ceiling tile.

MAIN FEATURES



Heating/cooling actuator

Actuators and valves are fixed on LYRA in factory. It is delivered with push-on connections. A very simple operation allows the installer to connect it with no risk of leakage.



Condensation sensor

LYRA beams with integrated control can be delivered with condensation detector mounted.

Communication

Modbus or Bacnet.

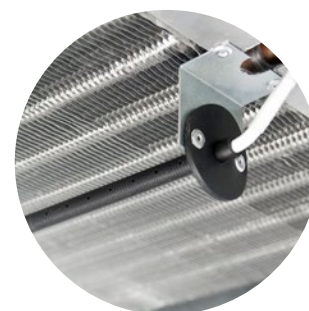

Temperature sensor

For LYRA with wall or flush mounted controller, the temperature sensor is built-into room controller. A temperature sensor is installed below the coil, when the controller is mounted on the side of LYRA.

LYRA – advantages at a glance



PROPERTY OWNERS

- **High indoor air climate comfort**
– silent and draught free diffusion
- **Flexibility in building lay-out**
– adjustable capacity and air diffusion
- **Low life cycle cost** – reduced energy consumption and maintenance costs

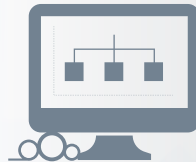

CONSULTANTS

- **Energy savings** – reduced chiller consumption load and electrical consumption, use of free-cooling
- **Ease of layout design**
– compact unit with high cooling capacity, adjustable induction and air diffusion
- **High indoor air climate comfort**
– silent unit and low air velocity in the room



INSTALLATION/MAINTENANCE ENGINEERS

- **Quick and easy installation**
– smart fastening brackets system, Plug & Play integrated controls
- **Simple commissioning**
– no tools required for adjusting air diffusion and induction
- **Low maintenance**
– no moving parts, no condensation tray and drop-down front plate allow easy cleaning



SELECT – PRODUCT SELECTION TOOL FOR CHILLED BEAMS

SELECT is FläktGroup's web based product selection tool for calculation and documentation. The tool shows all products, functions and features visually, which makes it very easy to use. www.flaktgroup.com

SELECT contains:

- 3D presentation of all products
- 3D presentations of the flow patterns in selected rooms
- A calculation and dimensioning tool
- Installation and maintenance manuals
- Connections with MagiCad or Revit (plugin or database)

EXCELLENCE IN SOLUTIONS

WWW.FLAKTGROUP.GB

LYRA 9353GB

FläktGroup is the European market leader for smart and energy efficient Indoor Air and Critical Air solutions to support every application area. We offer our customers innovative technologies, high quality and outstanding performance supported by more than a century of accumulated industry experience. The widest product range in the market, and strong market presence in 65 countries worldwide, guarantee that we are always by your side, ready to deliver Excellence in Solutions.

PRODUCT FUNCTIONS BY FLÄKTGROUP

Air Treatment | Air Movement | Air Diffusion
Air Distribution | Air Filtration | Air Management & ATD's
Air Conditioning & Heating | Controls | Service



» Learn more on www.flaktgroup.com
or contact one of our offices