

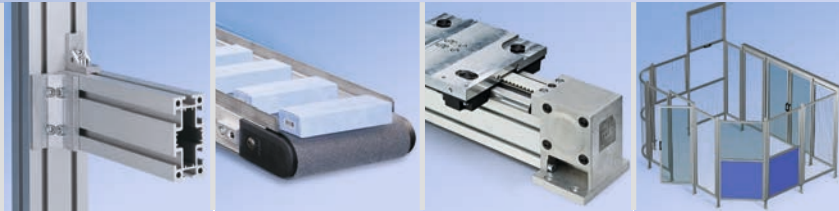

One Construction Kit.
Many Possibilities.

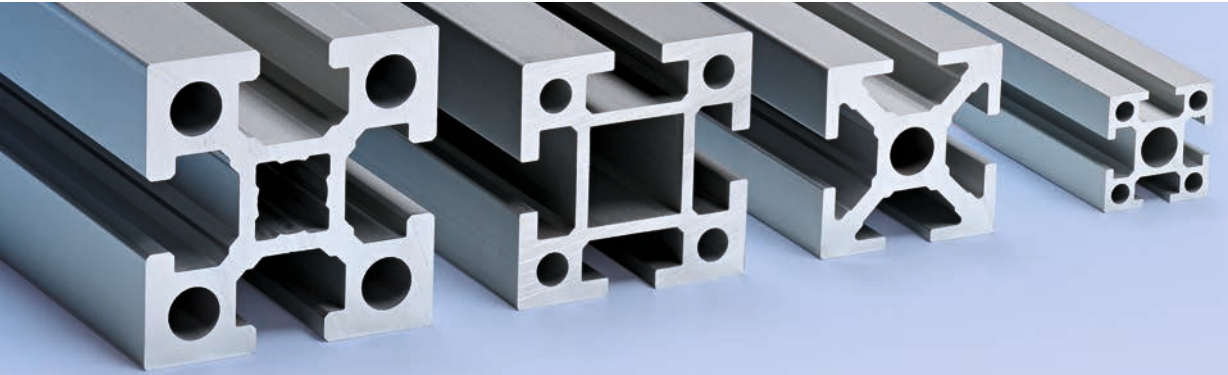

Profile Technology
Conveyor Technology
Linear Motion
Factory Equipment
Transfer Systems

Introducing mk Our modular system

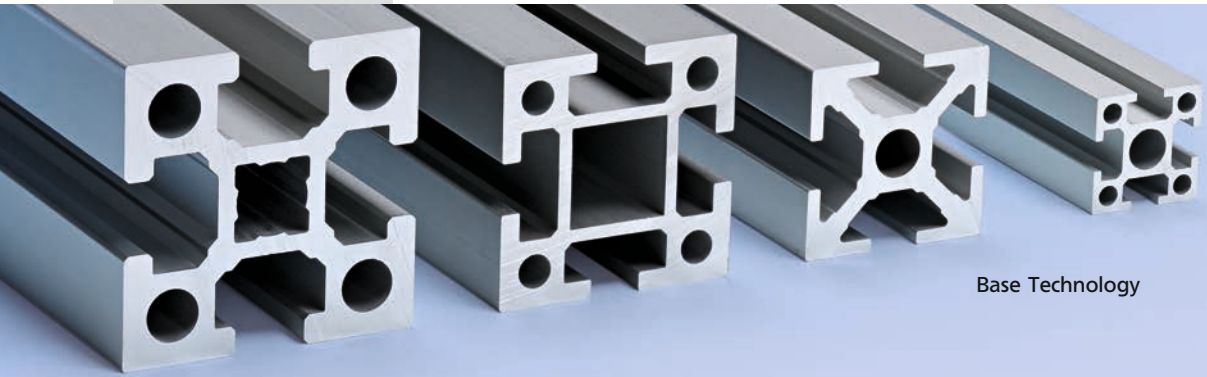

Base Technology



Profile Technology



Conveyor Technology

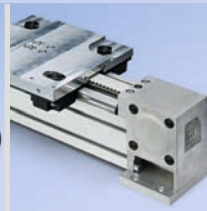

Linear Motion

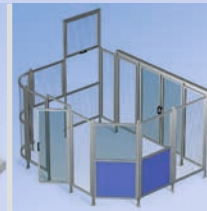

Factory
Equipment

Advantages of the mk modular system

- Everything comes from one source: interchangeable modules and components for profile, conveyor and linear technology, as well as factory equipment
- In addition, planning, design, installation and commissioning of complete transfer systems incl. control systems
- Coverage of all basic mechanical functions for modern factory automation
- Reduced need for special designs resulting in a reduction of costs due to the high level of standardization and the availability of over 250 profiles
- High material quality, solid connecting technology and high-quality accessories guarantee high loading capacity and long service life
- The highest flexibility for system extensions or alterations due to the reusability of individual components and modules
- The degree of assembly of our products can be freely selected, guaranteeing optimum adaptation to the existing utilization of resources at all times

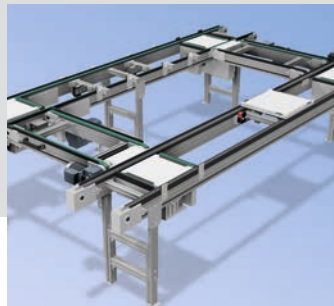

„We live our passion for technology – that shapes us for over 40 years“

Maschinenbau Kitz GmbH, was founded in 1966 and is headquartered in Troisdorf, near Bonn, Germany and operates internationally together with its subsidiaries and sales partners as the “mk Technology Group”. mk is the leading supplier of mechanical modules and components for profile, conveyor and linear technology, as well as factory equipment. In addition, we are at our customers’ side from the project planning and design phase, to implementation, commissioning and maintenance of

complete transfer systems. The base for the mk modular system is our variety of 250 different aluminium profiles and comprehensive assembly and extensively components. The resulting benefits are considerable cost savings during the installation of systems as well as a high degree of flexibility for extensions and reconstructions. Our most important target sectors include the machine construction, as well as the automotive, electrical, packaging, pharmaceutical, and food industries.



Our products –
mk Profile Technology



Advantages of mk profile technology

- It has one of the widest ranging profile systems on the market with more than 250 different profiles
- High load capacity connecting methods
- A comprehensive range of accessories
- Seamless connections between mk profiles through the small edge radius of 1 mm
- Easy assembly
- Use of high-quality materials
- Reusability of dismantled components
- The degree of assembly is customer selectable: mk supplies components or finished modules
- Online CAD library
- Competent advice from mk sales engineers
- Series 50 and 60 profiles of especially high-quality alloy

Our Profile Series

With four aluminum profile series – categorized by their base dimensions of 25, 40, 50, 60 mm – the ideal profile series is available for any application.

Simple frames with small space requirements can be realized just as effectively as load-bearing structures for heavy machinery.

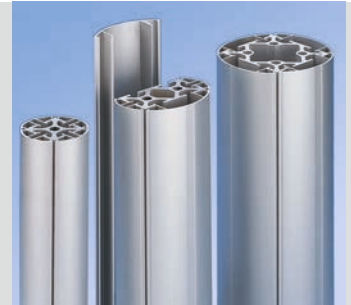

Profile series

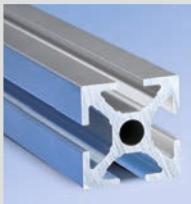
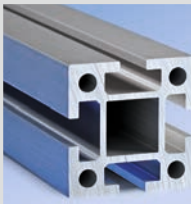
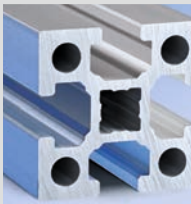
				
	<i>Series 25</i>	<i>Series 40</i>	<i>Series 50</i>	<i>Series 60</i>
Versions	normal	normal, light, extra light	normal, light	normal
Material	EN AW 6063 T66 AlMgSi 0.5 F25	EN AW 6063 T66 AlMgSi 0.5 F25	EN AW 6005A T6 AlMgSi 0.7 F28	EN AW 6005A T6 AlMgSi 0.7 F28
Classic applications	lightweight frames, display cases, display cabinets, intricate test setups, measuring and test equipment, control cabinets, electronic housings	lightweight machine racks, frames, guarding, assembly workstations, show booths, work platforms	heavy machine racks, load-bearing structures	machine frames for maximum loads, portals
Base dimensions	25 x 25 mm	40 x 40 mm	50 x 50 mm	60 x 60 mm



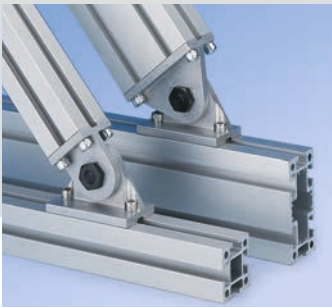

Our Assembly Components

mk connection technology offers you freedom in design. Both 90° connections and variable angles connections can be used, based on your application requirements. The following table lists the most

important criteria for selecting the right connector for your design. mk does not require, for example, any system-specific screws in its construction kit. Standard screws can be used for all assembly work.



Selection of assembly components

					
	<i>Tension plugs</i>	<i>Angles</i>	<i>Corner blocks</i>	<i>Plates</i>	<i>Clamps</i>
Locking element	no	yes	no	yes	no
T-slots remain open	yes	no	no	no	no
Loading capacity	medium	high	medium	high	medium
End services	yes	no	yes	no	no

Our Accessory Components

Accessory components from mk fit perfectly into the mk construction kit system. The comprehensive assortment includes floor mountings, fixed and swivel casters, various operating elements, elements for

doors, paneling for guarding, elements for closing and sealing profiles, as well as pneumatic and electric components. As a result, profile designs can be configured based on the customer's requirements.

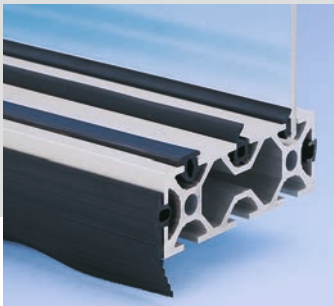

Advantages of accessory components

- Comprehensive range of components for all profile systems
- Profile designs completed to the required customer-specific functions
- Range of accessories perfectly tailored to the profile systems based on years of experience
- High-quality accessories ensure high loading capacity and long service life
- Short assembly times due to quick and easy assembly and disassembly
- mk accessories largely consist of reusable components
- Assembly and disassembly with standard conventional tools
- mk offers all special tools that may be required at reasonable prices

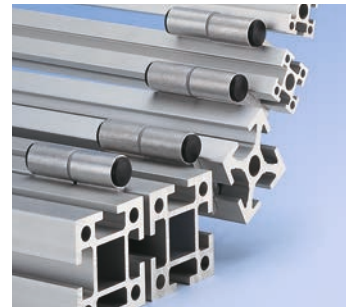

Our products –
mk Conveyor Technology



Advantages of mk conveyor technology

- Optimum functionality for all goods to be conveyed and every implementation environment, thanks to 20 standardized conveyor systems
- Maximum process reliability through: Mature technology, high-quality materials and purchased parts, as well as fast spare parts delivery worldwide
- Cost savings and short delivery times due to standard modular construction
- High competence in the design and manufacturing of individual conveyors outside of the standard product range
- Flexible through compatibility with all other mk products, like profile technology, linear motion and factory equipment
- Competent advice and support in design from mk sales engineers
- Online configurator, mk QuickDesigner, including CAD model and quote

By selecting the optimal system for your conveyor requirements, mk guarantees maximum process safety. For detailed information,

please have a look in our catalogue mk Conveyor Technology. Try also our online configurator www.quickdesigner.com.



Factors that influence the configuration of the conveyor

The products to be transported

- Weight of the individual product
- Total weight
- Shape of the contact surface
- Size
- Temperature
- Impact-sensitivity
- Dry vs. wet
- Oily
- Sharp-edged
- Other product-specific characteristics

The environmental conditions

- Temperature
- Contamination, e.g. dust or chemicals
- Explosion protection requirements
- Clean room conditions
- Food industry applications
- Humidity

The transport path

- Straight-line vs. curved transport
- Transport on one level vs. different height levels
- Discharge quantity and speed
- Defined vs. undefined orientation/transfer/handling of the product

The operating mode

- Continuous operation vs. accumulated operation
- Cycle operation, on/off operation
- Stopping/positioning
- Reversing operation

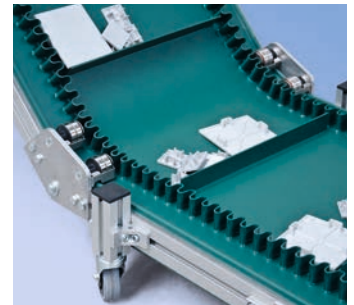

mk Conveyor Technology – **Belt Conveyors**



Advantages of mk belt conveyors

- Can be integrated perfectly in complex machines thanks to its compact design
- Use of lateral T-slots for optional attachments of stands, side rails or other accessories
- Profile design ensures torsion-resistant setup with good load-bearing properties
- Drive rollers can be rubberized when the high torque of a motor has to be transferred
- Crowned drive or return rollers simplify belt tracking and tensioning
- The GUF and KGF belt conveyors have continuous slider beds made of stainless steel to achieve lasting durability
- Support rollers ensure the belt returns tight to the bottom of the frame
- Quick Delivery Program (QDP) offers fast delivery of current belt conveyors

GUF-P MINI



This is a conveyor with a compact design for optimal integration in complex machines. Integrated belt return for direct support on underframe. For light products.

- Conveyor width B: 75, 100 and 150 mm
- Conveyor length: between 360-5000 mm
- Belt width: B-15 mm
- Total load to 25 kg (55 lbs), section load to 10 kg (22 lbs)/m
- Drive and speed: up to 50 m/min (160 ft/min)
- Online configurable at www.quickdesigner.com

GUF-P 2000



Versatile conveyor due to the variety of tails and drives. Suitable for light and medium-weight products.

- Standard conveyor width B: 50, 100, 150, 200, 250, 300, 400, 500, 600, 700, 800 mm
- Conveyor length: between 380-10.000 mm
- Belt width: B-10 mm
- Total load to 75 kg (165 lbs), section load to 25 kg (55 lbs)/m
- Drive and speed: up to 80 m/min (260 ft/min)
- Online configurable at www.quickdesigner.com

GUF-P 2041



Conveyor for high load capacities and/or wide products.

- Standard conveyor width B: 200-1200 mm (in 100 mm increments)
- Conveyor length: between 540-10.000 mm
- Belt width: B-15 mm
- Total load to 150 kg (330 lbs), section load to 50 kg (110 lbs)/m
- Drive and speed: up to 60 m/min (200 ft/min)
- Online configurable at www.quickdesigner.com

GUF-P 2004



Special conveyor for particularly high load capacities and/or particularly wide products.

- Standard conveyor width B: 200-2000 mm (in 100 mm increments)
- Conveyor length: between 720-20.000 mm
- Belt width: B-50 mm
- Total load to 200 kg (440 lbs), section load to 75 kg (165 lbs)/m
- Drive and speed: up to 60 m/min (200 ft/min)

mk Conveyor Technology – Belt Conveyors

KFG-P 2000

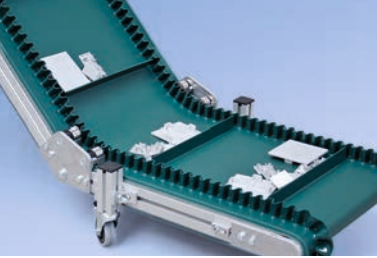

For transporting small parts. Compact frame makes setup and integration into existing systems easier.

- Conveyor width B: 300-700 mm (in 100 mm increments)
- Conveyor length: 1400 to approx. 4000 mm
- Bend: 30, 45 and 60°
- Total load to 40 kg (88 lbs), section load to 25 kg (55 lbs)/m, 5 kg/field
- Drive and speed: up to 15 m/min (50 ft/min)

KGF-P 2040



Extremely low wear and low maintenance curved conveyor for light and medium-weight products.

- Conveyor angle: 90° and 180°
- Usable widths B: 300 at Ra=600 mm, Ri=300 mm, FB=706
400 at Ra=900 mm, Ri=500 mm, FB=1006
500 at Ra=900 mm, Ri=400 mm, FB=1006
600 at Ra=900 mm, Ri=300 mm, FB=1006
- Load capacity max.: 30 kg (65 lbs)
- Drive and speed: 5 to 30 m/min (15 to 100 ft/min)

DGF-P 2001

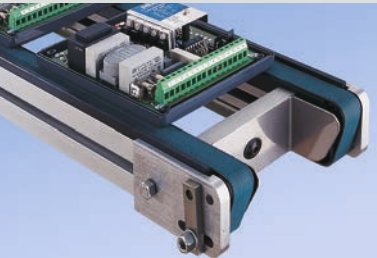

Dual belt conveyor for light products. Ideal for transporting small pallets.

- Standard conveyor width B: 100, 125, 150, 175, 200 and 250 mm
- Conveyor length: between 300-2000 mm
- Belt width: 18 mm
- Total load to 15 kg (33 lbs), section load to 10 kg (22 lbs)/m
- Drive and speed: up to 15 m/min (50 ft/min)

GUF-I mk INOX Belt Conveyors

Belt Conveyors

Application Examples

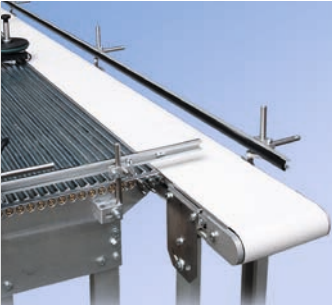

GUF-P 2000 as transverse conveyor and singulator following a cooling section

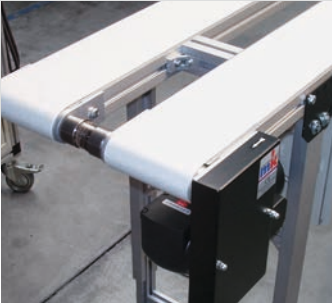

Two conveyor belts driven by one motor at the head drive



Two GUF-P 2041 in tandem arrangement with mobile stand system for mobile double feeding of a system



GUF-P 2004 with separate working and return side of belt



GUF-P 2000 as transverse conveyor and singulator following a cooling section

mk Conveyor Technology – **Modular Belt Conveyors**

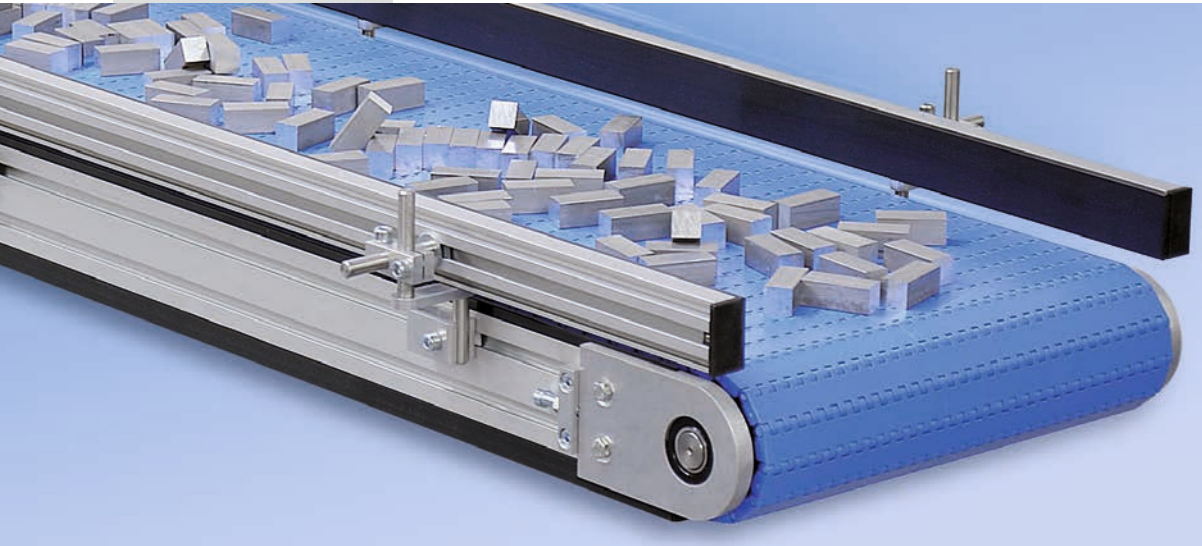

Advantages of mk modular belt conveyors

- High load capacities possible
- Positive belt tracking means no lateral wander
- Belt material is highly resistant to wear and abrasion
- A wide variety of belting is available; standard, food grade, chemical resistant and high temperature
- Accessories available include sidewalls and longitudinal cleat profiles
- Maintenance work such as tensioning the belt or replacing individual components is quick and easy

MBF-P 2040

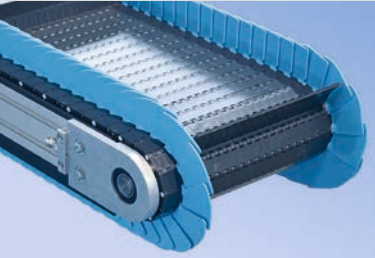

MBF-P 2040 for high loads. Various chain materials available.

- Conveyor width B: 200-1000 mm
- Conveyor length: between 475-10.000 mm
- Total load to 250 kg (550 lbs), section load to 75 kg (165 lbs)/m
- Drive and speed: up to 30 m/min (100 ft/min)

KFM-P 2040

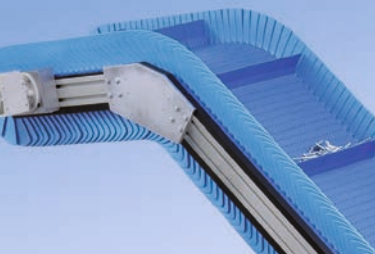

For transporting injection molded parts, light punched parts or foodstuffs. Various chain materials allow use at high temperatures.

- Conveyor width B: 200-1000 mm
- Conveyor length: up to 4000 mm
- Bend: 15, 30, 45 and 60°
- Total load to 100 kg (220 lbs), section load to 50 kg/m, 15 kg/field
- Drive and speed: up to 30 m/min (100 ft/min)

KFS-P 2040.86



For transporting punched, cast, forged or wood parts. Particularly well-suited for transporting hot workpieces. Not suitable for sharp expiring punshing waste or metal chips.

- Conveyor width B: 210-710 mm (in 50 mm increments)
- Conveyor length: up to 10.000 mm
- Bend: 15, 30, 45 and 60°
- Total load to 150 kg (330 lbs), section load to 50 kg/m, 15 kg/field
- Drive and speed: up to 12 m/min (39 ft/min)

mk Conveyor Technology – Timing Belt Conveyor



Advantages of mk timing belt conveyor

- Well-suited for transporting heavy workpiece frames or dimensionally stable products
- Synchronous operation of the drive belts via interlocking connection between drive pulley and timing belt
- Suitable for indexing
- Low friction with very good wear characteristics
- Minimized risk of accidents thanks to belt return in the interior of the profile
- Connection options for stands, side rails and stoppers in the existing T-slots (10 mm width)
- This system forms the basis for setting up complex transfer systems for workpiece frames
- Various backings of the timing belts make traction of the workpiece optimally matched for the application case

ZRF-P 2040



Well-suited for the synchronized transport of products.
 For conveying, handling and positioning.

- Conveyor width B: 40, 80, 120 and 160 mm
- Conveyor length: between 650-6000 mm
- Timing Belt width: 32, 70, 110 and 150 mm
- Total load to 125 kg, section load to 50 kg/m for B = 40 mm
 total load to 250 kg, section load to 100 kg/m from B = 80 mm
- Drive and speed: up to 60 m/min (200 ft/min)

ZRF-P 2010

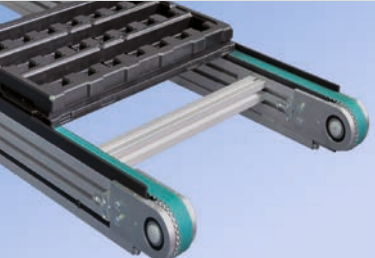

Ideal for transporting workpiece frames or dimensionally stable products.

- Conveyor width B: 200-1000 mm
- Conveyor length: between 500-6000 mm
- Timing Belt width: 32 mm
- Total load to 250 kg (550 lbs), section load to 100 kg (220 lbs)/m
- Drive and speed: up to 60 m/min (200 ft/min)

mk Conveyor Technology – Chain Conveyors

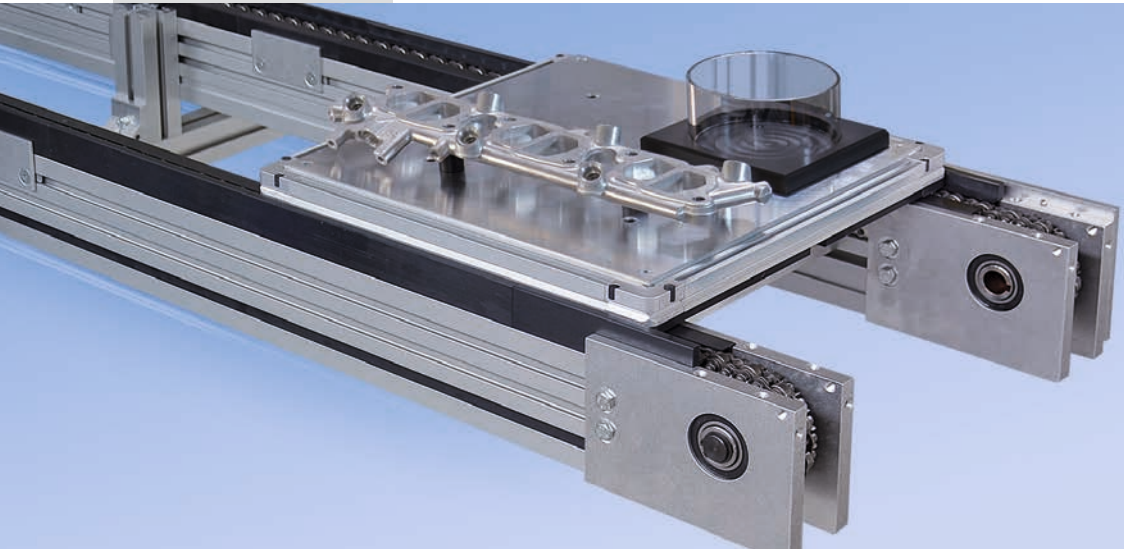

Advantages of mk chain conveyors

- Base element for building transfer systems
- Various chains or wear strip types (PE1000) make optional support of the workpiece on the conveyor possible
- Very good accumulation properties
- Extremely low maintenance and robust
- Longitudinal grooves in the profile frame provide versatile mounting options for braces, guides, stops, stands and rails

KTF-P 2010



Chain conveyor for medium loads. Ideal for pallet transport (single, double and multi-cord systems).

- Conveyor width B: 200-2000 mm
- Conveyor length: between 500-10.000 mm
- Chain: 1/2" single or dual strand
- Total load to 1000 kg (2200 lbs), section load to 150 kg (330 lbs)/m (with duplex chain)
- Drive and speed: up to 30 m/min (100 ft/min)

SRF-P 2010



Accumulating roller chain conveyor for medium loads. Suitable for accumulated operation. Ideal for interlinking and buffering between workstations and for pallet transport.

- Conveyor width B: 200-2000 mm
- Conveyor length: between 500-10.000 mm
- Chain: accumulating roller chain 1/2" with plastic or steel roller
- Total load to 750 kg (1650 lbs), section load to 100 kg/m (in series), section load to 150 kg/m (offset)
- Drive and speed: up to 30 m/min (100 ft/min)

SRF-P 2012

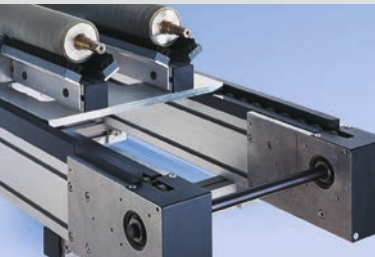

Accumulating roller chain conveyor for the high load range. Very smooth running even in accumulated operation.

- Conveyor width B: 200-2000 mm
- Conveyor length: between 1000-10.000 mm
- Chain: accumulating roller chain 3/4" with plastic or steel roller
- Total load to 1000 kg (2200 lbs), section load to 150 kg (330 lbs)/m
- Drive and speed: up to 30 m/min (100 ft/min)

mk Conveyor Technology – Flat Top Chain Conveyors

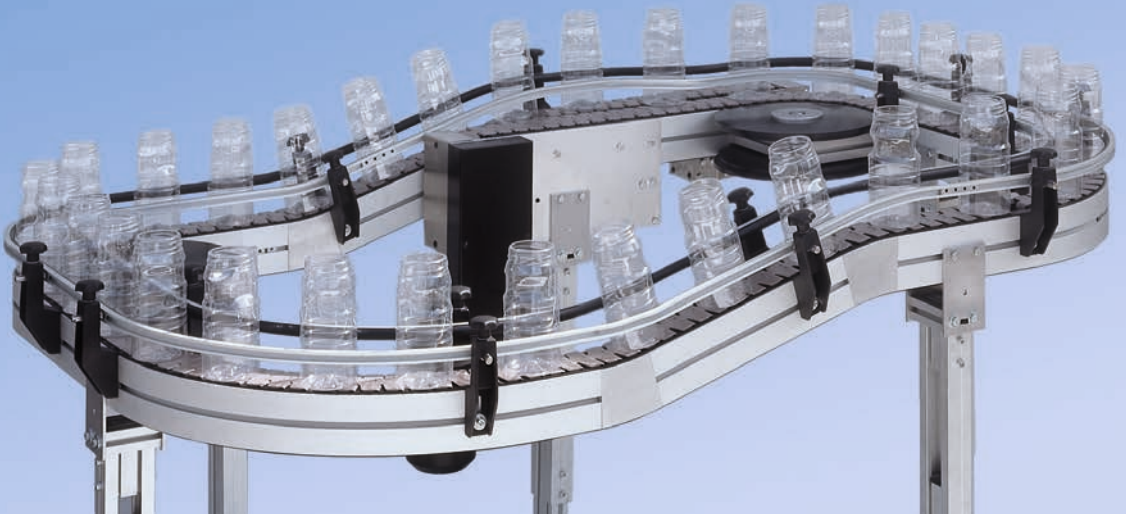

Advantages of mk flat top chain conveyors

- Ideally suited for use in delivery and interlinking technology
- A complex conveyor systems can be quickly and cost effectively be realized thanks to the modular design
- Production-related changes in the routing can be realized without great effort
- Available in various widths
- Accessories such as side rails, stands, etc. can be mounted to the lateral T-slots (10 mm width) of the conveyor frame
- Chain is guided entirely in a wear strip (PE1000) track, which is fastened to the profile frame

SBF-P 2254

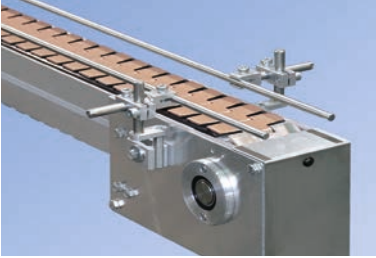

For transport requirements in the beverages, glass, food, pharmaceutical and paint industries.

- Conveyor width B: 100 mm and 130 mm
- Conveyor length: between 600-15000 mm
- Drive and speed: up to 40 m/min (130 ft/min)

SBF-I mk INOX Flat Top Chain Conveyors

Flat Top Chain Conveyors

Application examples

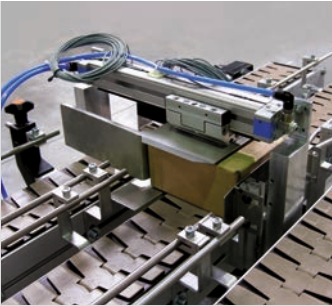

SBF-P 2254 with transfer pusher, e.g. for the packaging industry

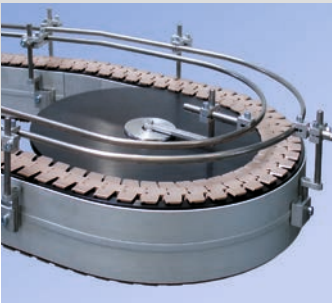

180° Curve

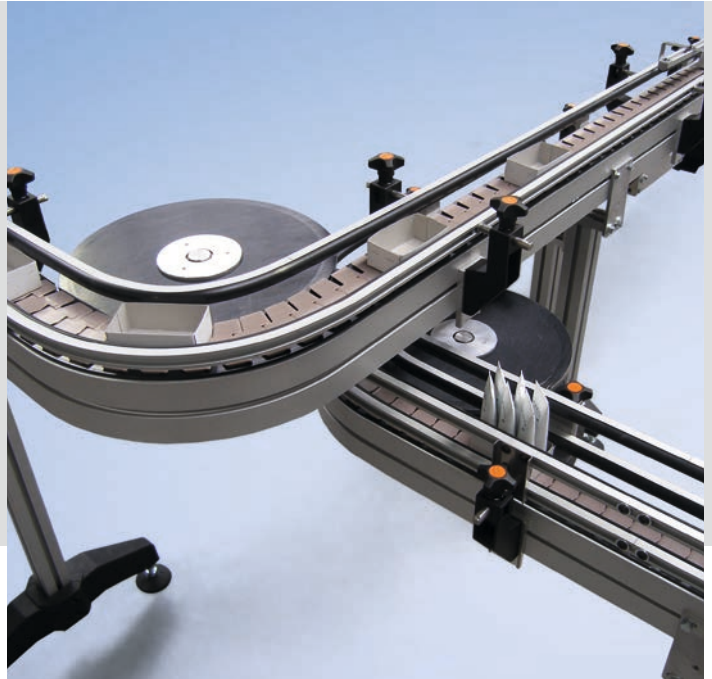

SBF-P 2254 for transporting cartons before and after filling

mk Conveyor Technology – Roller Conveyors



Advantages of mk roller conveyors

- Wide range of applications thanks to the different drive concepts (gravity, tangential chain, motor rollers)
- Very well-suited for integration in complex machines due to its compact design
- All systems available straight and curved
- All roller conveyors of system 2255 can be combined
- Wide range of different roller types
- Easy to assemble and maintain
- Quick roller replacement
- Chain guide and protective guard integrated in the side rail

RBS-P 2065/2066



Gravity roller conveyer for transporting light to medium-weight products. System 2065 can transport extra wide workpieces.

For straight run

- Frame widths: between 150 and 1050 mm (depending on roller types)
- Conveyor length: 200-5000 mm

For curve

- Frame widths: 250-800 mm
- Inner radius: 800 and 850 mm depending upon usable width

RBS-P 2255



Gravity roller conveyer for transporting medium-weight products. Can be combined with our driven roller conveyors.

For straight run

- Frame widths: 290, 390, 490, 590 and 690 mm
- Conveyor length: 500-10.000 mm

For curve

- Frame widths: 290, 390, 490, 590 and 690 mm
- Inner radius: 800 mm

RBT-P 2255

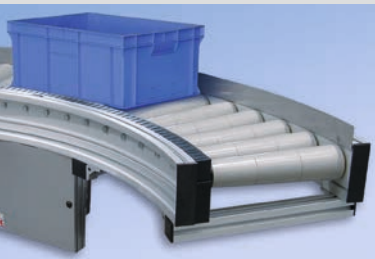

Roller conveyor with tangential chain drive. Also suitable for dirty or oily environments.

For straight run

- Frame widths: 420, 520, 620 and 720 mm
- Conveyor length: 600-10.000 mm

For curve

- Frame widths: 420, 520, 620 and 720 mm
- Inner radius: 800 mm

RBM-P 2255



Roller conveyor with motorized drive roller. Different speeds and start/stop functions can be realized due to separately driven sections.

For straight run

- Frame widths: 380, 480, 580 and 680 mm
- Conveyor length: 500-10.000 mm

For curve

- Frame widths: 380, 480, 580 and 680 mm
- Inner radius: 800 mm

mk Conveyor Technology – **mk INOX Stainless Steel Conveyors**



Advantages of mk INOX stainless steel conveyors

- Individualized consultation and design concepts in accordance with customers' requirements
- Consistent implementation of time-tested modularization principles from aluminum profile technology and conveyor technology
- Use of stainless steel of varying grades, depending on the intended application and conditions. Acceptance test certificate to EN 10204 on request.
- Use of FDA-compliant materials and components
- Fast, easy and thorough cleaning thanks to the open design and quick disassembly/reassembly elements for the belt or the flat top chain
- Standard or customizable sheet metal profile punching for easy integration into existing systems, or for attachment of components
- Customer references include the fields of medical engineering, pharmaceuticals and cosmetics, the solar industry, as well as the food industry
- Extensive accessory range comprises stands, side rails, end stops, drip pans, discharge chutes, and electronic components used for controlling tasks and component inspection

GUF-I



For optimal transport of packaged goods in areas with high cleanliness requirements. Compact design with integrated belt return for optimal integration in complex machines. For light to medium-weight products.

- Conveyor width B: 100-500 mm
- Conveyor length: between 410-6000 mm
- Belt width: B-15 mm
- Load capacity max.: 75 kg
- Speed: up to v=40 m/min (control options available)

RBS-I



For optimal transport of containers or pallets in areas with high cleanliness requirements. Wide range of conveyor rollers for different size and weight classes.

- Frame width: 150-650 mm (depending on roller types)
- Conveyor length: min. 500 mm - max. on request
- Roller types: ø 20, 40 and 50 mm, versions in plastic or stainless steel
- Max. load: on request (depending on configuration)

SBF-I



For optimal transport of containers and packages in areas with high cleanliness requirements. Fully modularized program of straight sections, curves, vertical inclines, side transfers, as well as drives and trails.

- Conveyor width B: 100 mm, 130 mm
- Conveyor length and track routing: individuel
- Flat top chain width: 82.5 mm, 114.3 mm
- Load capacity: on request (dependent on configuration)
- Drive and speed: from 4 to 40 m/min

Our products –
mk Linear Motion

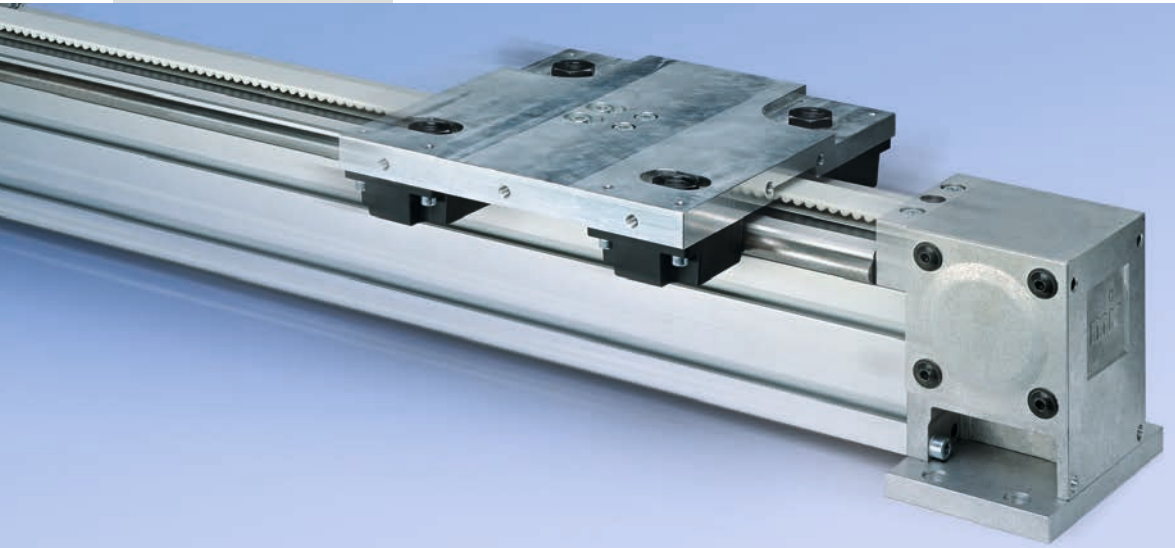

Advantages of mk linear motion

- Optimal functionality thanks to the wide range of tracks designed to meet customer needs
- Material, cost and space savings due to compatibility with mk profile series: Tracks can be mounted to the existing supporting structure directly
- Fast and easy installation of linear tracks due to add-on principle
- Precision running with mk clamping profile ensures maximum parallelism of the guide rods
- High reliability due to high-quality materials and tested manufactured parts
- Competent advice and support in design from mk sales engineers

Criteria for the selection of the right guide

Criteria for Gliding Assemblies

- High static load capacity
- Low maintenance, good wear resistance
- Good damping
- Compact construction
- Quiet

Criteria for Track Roller Assemblies

- Compensate for relatively large misalignments
- Well suited for dirty environments (dust, chips, etc.)

- Suitable for high accelerations (to $a = 50 \text{ m/s}^2$) and high speeds (to $v = 10 \text{ m/s}$)
- Low rolling resistance
- Light to medium loads
- Economically practical solution over longer lengths through simple mounting of track
- Can be loaded in all directions (forces and moments)
- Varying preload setting using eccentric bushings

Criteria for Recirculating Ball Bearing Guides

- 4-row recirculating ball bearings can be loaded in all directions (forces and moments)
- High load capacity, high stiffness
- Compact construction
- One track accommodates various carriage types
- Lightly preloaded (standard), available with play and higher preloads
- Medium to high accelerations (to $a = 30 \text{ m/s}^2$) and speeds (to $v = 5 \text{ m/s}$)
- High precision of carriages

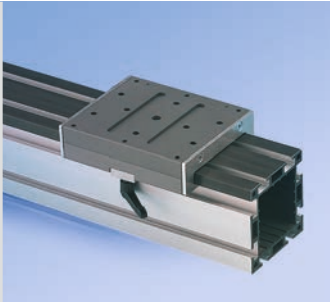

Gliding assemblies

Gliding assemblies

- High static loading capacity due to large contact surfaces ensures low maintenance operation
- Good wear compensation
- Good damping
- Compact design
- Quiet
- For applications with need for manual adjustment



Track roller assemblies

Track roller assemblies

- Compensate for relatively large misalignment
- Well-suited to dirty environments
- High accelerations
- Low rolling resistance
- Simple and cost-effective mounting of the track
- Can be loaded in all directions

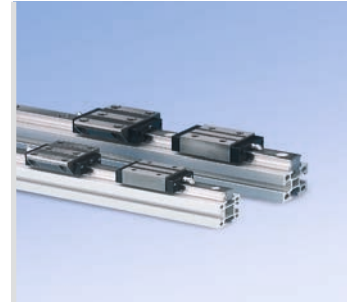

Recirculating ball bearing guides

Recirculating ball bearing guides

- Can be loaded in all directions
- High load capacity
- High rigidity
- Compact design
- One track for different carriage types
- High accelerations
- High speeds
- High precision

Our products – mk Linear Motion



Advantages of the Add-on-Principle

Our product philosophy is focused on providing modular solutions for technically demanding manufacturing and automation applications while maintaining high standards of rigidity, functionality and flexibility.

- Total compatibility with the structural profiles of the mk Profile System
- Quick and economical manufacture of linear modules using the "add-on" principle
- Fast assembly and easy integration into existing structures

The "add-on" principle is a basic concept for integrating linear motion within machine frames or other structures by attaching pre-engineered linear components. Among other advantages, this method significantly reduces the material content and cost.

Application Example
Structural Profile Series 50
and LZR 2000-38.41-15.

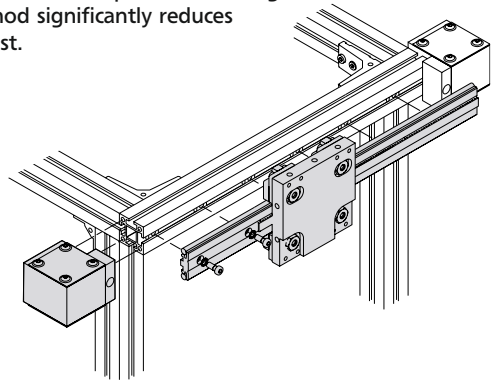

mk linear modules

mk linear modules have been designed for adjusting- and positioning tasks. High-value coating of the wear surface serves for wear protection and reduced friction. Linear modules are available

with one or two slide carriages, optionally travelling in co-rotation or a counter-rotating way. They are available with or without a scale, as well as driven manually or motor-driven. They are maintenance-free to a large extent.

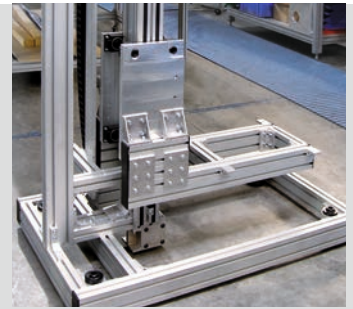

mk linear modules with timing belts

Due to their bend-proof structure mk LZR linear modules allow for high accelerations and speeds during a long operating times. They are perfectly suitable for applications of single axis or as multiple-axes systems. The track roller assembly is assembled in a bend-proof way by means of

high-performance bearings. The excentrically mounted guide rollers inhibit play. The high-performance drive system permits quick positioning on a high level of repetition the precision. These modules meet highest requirements with regards to technical and economical standards.

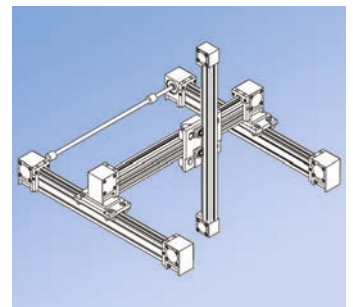
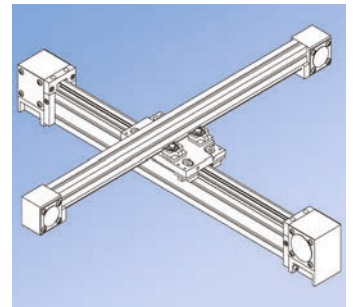

Our products – mk Factory Equipment

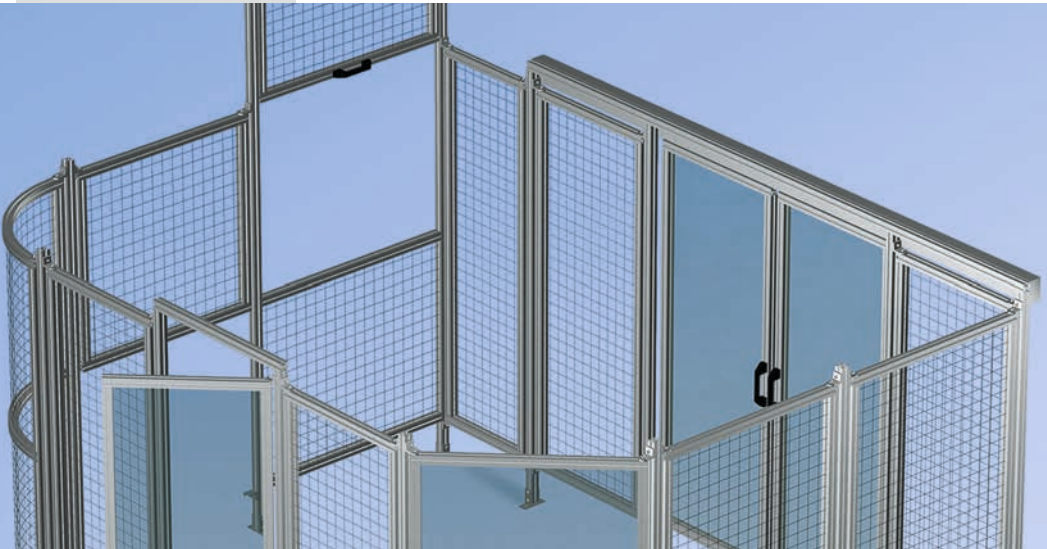

Advantages of mk factory equipment

- Fast and easy design and manufacture of individual guardings and workstations due to the modular design
- Less project-related fabrication leads to reduced costs due to the use of standardized and compatible modules
- Optimal functionality and ergonomics for workplaces and workstations thanks to a comprehensive construction kit system
- Easy conversion or expansion due to compatibility of the modules and reusable connection technology allows constant adjustment for changing assembly processes
- Attractive design of workstations thanks to the use of high-quality aluminum profiles
- Complementary assortment of dimensionally accurate guard rails, treads and platforms for safe work on your systems
- mk Config – the 3D product configurator for guardings simplifies planning and reduces project costs
- Rapid availability of all modules and individual parts from stock

Our Products in Factory Equipment

Our 3D configurator (mk-Config) allows you to construct guards with swinging, sliding and lift doors. Using individual modules, individual workstations for the

workshop, assembly areas or offices can also be set up. Our modules are complimented by a comprehensive range of stylish and functional guard rails, treads

and platforms that allow you to individually design your work areas and buildings.

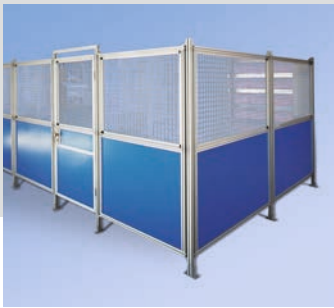

Guarding



Workstations



Guard rails, treads, platforms

Guarding

With guarding from mk, you are opting for a flexible and economic modular design. Choose from a large assortment of guarding modules, swinging door, sliding door and lift door elements that can be electrically secured on request. Pneumatic, hydraulic or electrically operated door elements can be easily integrated. mk allows you to design distance guarding that conforms to the applicable safety standards.

Workstations

The mk system makes it easy to custom design workstations in the workshop and in the assembly and office areas. Maximize the functionality and ergonomics of your workstations while remaining flexible and economical. The mk profile technology allows you to easily and cost-effectively design workstations based on your needs thanks to the modular design.

Guard rails, treads, platforms

Safe access and platforms for your plant can be easily build with the mk GTP-System. Based on the proven mk profile technology, dimensionally accurate individual solutions for access, transitions or even work platforms can also be set up.

mk Factory Equipment – **Guarding**

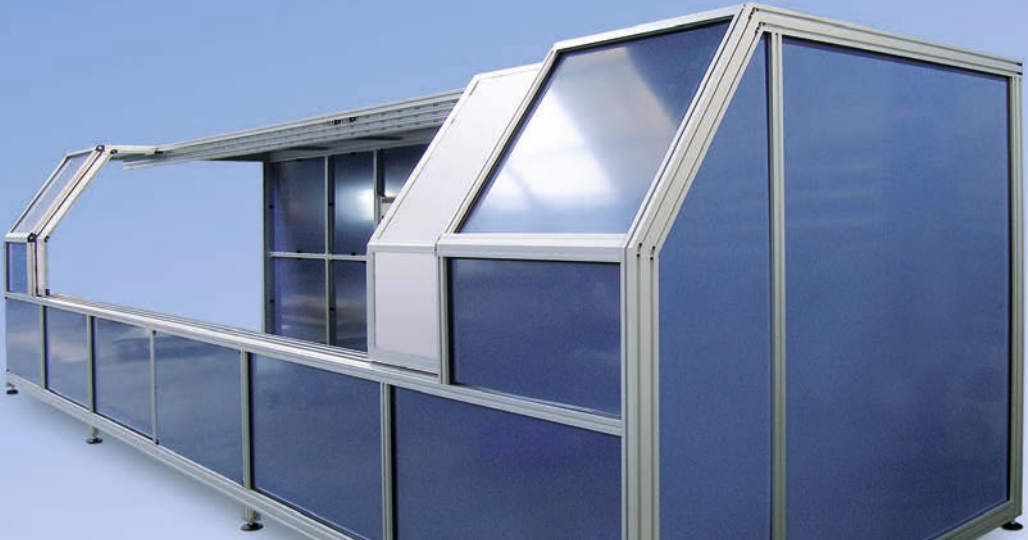

Advantages of mk guarding

- Universal compatibility and modularity thanks to two different standards based on the same base dimension
- An ergonomically advantageous result due to the favorable mass/strength ratio of the profile design during the handling and assembly of the elements
- Field connections with angles ensure maximum stability with little assembly effort
- Disassembly if necessary thanks to screw connections
- A large assortment of installation elements (partitions, posts, doors, etc.) and paneling
- Maximum flexibility for system extensions or alterations due to combinability and reusability of individual components and modules
- A wide variety options are available
- mk Config – the 3D product configurator for guardings simplifies planning and reduces project costs

mk distance guardings

mk offers various compatible standards of guarding. The range of products includes protective fields, sliding and lift doors, paneling and accessories for electrical

protection. mk also offers the "mk QuickDesigner" configuration software which uses current standards that greatly simplifies and accelerates inquiry and order handling.



mk machine housings and protective enclosures

With years of experience, mk supports both production and mechanical engineering companies as well as system integrators by tackling tasks related to occupational safety. Examples are safety devices for robots and integrated machines, clean rooms and soundproof booths or partitions and room dividers.

The mk aluminum profile system provides flexible connections, stability and an attractive design. All thanks to a large selection of components and modules, which create customer-specific guarding that is cost effective.



mk Factory Equipment – Workstations



Advantages of mk workstations

- Know-how in the area of customer-specific workstations guarantees a standardized and modular product platform for custom designs based on specific customer requirements
- mk workstation systems fit the person, not the reverse
- With changing production conditions, simple and economic adjustment to the new situation is easy and cost-effective
- Consistent system design of compatible elements, quality in material and workmanship and above all, a high level of utility ensure cost efficiency in the long term
- Competent advice and support in design from mk engineers

mk Factory Equipment – Guard Rails, Treads, Platforms



Advantages of mk GTP (guard rails, treads, platforms)

- This range of products is the perfect companion to the mk guarding and mk profile technology
- Through a variety of design options, the range of products combines safety requirements with the desired workplace ergonomics.
- As a result of the lightweight aluminum, assembly platforms can be mobile thanks to air cushions and swivel casters
- With changing production conditions, simple and economic adjustment to new situation is easy



mk Transfer Systems



Advantages of mk transfer and handling systems

- Planning, design, assembly, and commissioning of customer-specific systems for product transport – all from mk!
- They are based on standardized components and modules of the mk conveyor, linear and profile technology as well as mk factory equipment
- We offer maintenance and service contracts with uniquely definable response times
- Locally-based support is available through our global offices
- Internationally represented, notable suppliers provide replacement parts for parts subject to wear
- Comprehensive references in the automotive, electronics, food, pharmaceutical, household appliances, machine tools, packaging and plastics industry

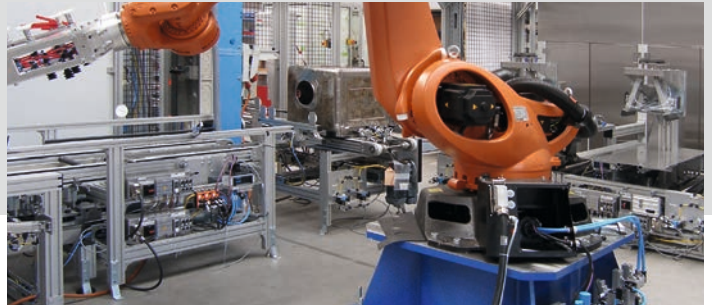
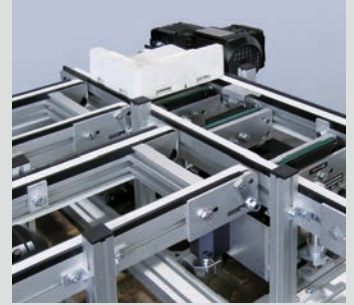

*Modules and much more –
 customized solutions*

Long-standing experience, robust products and innovative technologies are among the features of mk transfer systems. Equipped with modules and components from the mk modular system for Profile Technology, Conveyor Technology and Linear Motion, mk transfer systems are reliable and customizable and meet high quality standards.

With transfer systems from mk, products are individually moved in applications worldwide. The products can also be sorted, isolated, rotated or otherwise handled. We plan, design and install custom specific fully cross-linked cell solutions incl. control.



mk Transfer System WTU 2010

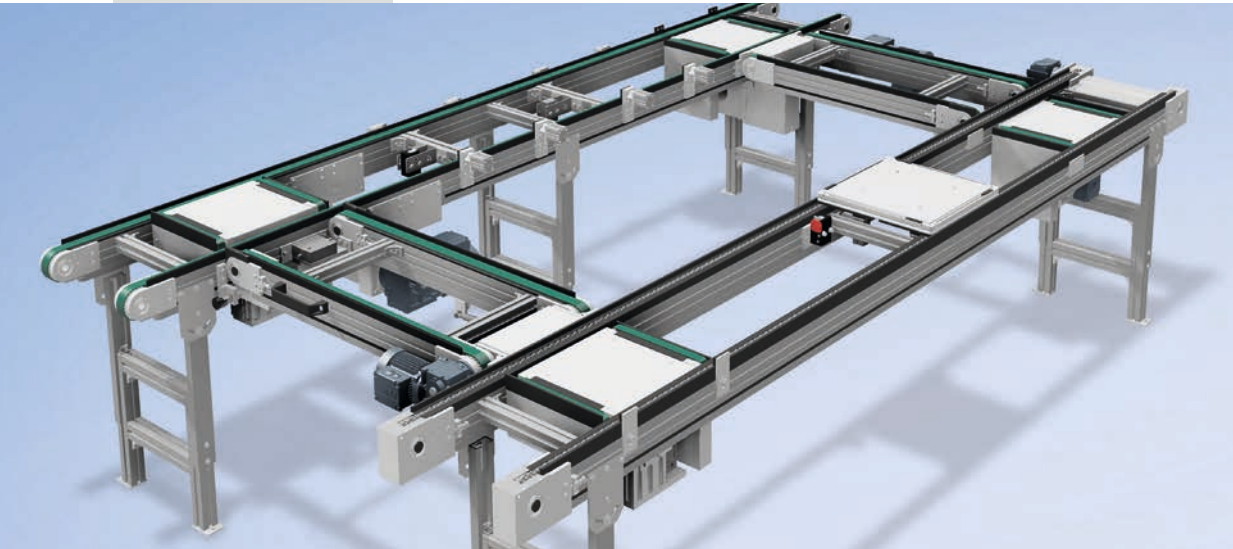

Advantages WTU 2010

- Modular transfer system for any type of material flow, ready for use upon request
- Safe transfer of pallets via timing belt conveyor, chain conveyor or accumulating roller chain conveyor
- Compact lift and transfer conveyor for transfer and separation
- Various precision Positioning Units
- Several transfer levels possible
- Safe stopping and separation
- High maximum load of up to 150 kg/m and 100 kg per pallet
- Within given system limitations, pallets of variable dimensions can be realized ranging from 400 x 400 mm to 800 x 1040 mm, with product-specific slots (optional)
- Consideration of individual environmental factors and customer-relevant material specifications

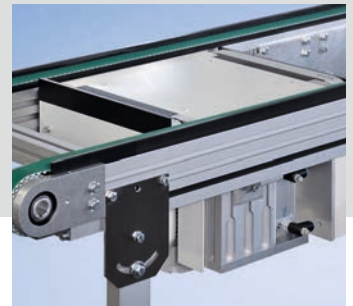
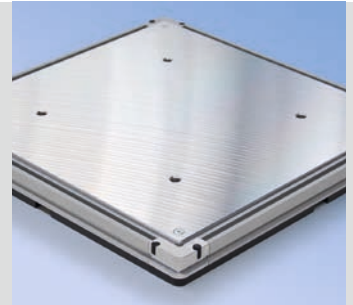

*Transfer System WTU 2010 –
 modular and efficient*

The design of the WTU 2010 is based on the mk 2010 profile (100 x 50 mm). Proven mk dual-lane conveyors with timing belt, chains or accumulating roller chains are used for transfer sections. The transfer system is precision-customized according to customer specifications with a combination of base modules, lift and transfer conveyors, positioning units, as well as stops and lifts. mk's range of services and products also includes control

systems, as well as the start-up and maintenance of the overall system upon request. Modifications and special features can be included and realized as early as the planning phase. The variable dimensions of pallets and slots enable use of the transfer system in virtually any area of the automation process and material flow. We provide customized solutions – flexibly, promptly and directly from mk.

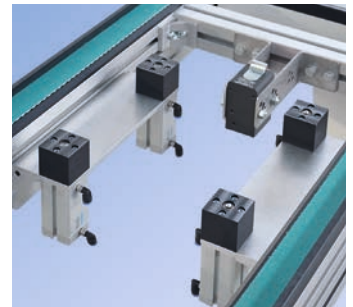

Service

mk customer service

We are at your side in each phase of a project – whether for on-site consulting, planning and design, or for maintenance and spare parts supply. Short delivery times with high availability are ensu-

red through our in-stock, modular system and our dense sales network. Our quality management, certified in accordance with EN ISO 9001, guarantees maximum process reliability.

Spare parts supply

Extensive, well-sorted spare part warehouse guarantee fastest availability



On-site consulting

We are in your area. Your personal customer service representative would be pleased to support you and advise you



Maintenance and service on site

Our service team offers service and maintenance over the entire life cycle



Planning and design

Our design team provides custom designs to your specifications



Fast delivery and high availability

We guarantee this through our in-stock modular system



Quality management

Our quality management, certified in accordance with EN ISO 9001, guarantees the highest level of process reliability



With mk at your side, you've decided for more than a supplier of components, modules and complete systems in the highest quality and at the agreed

delivery date. We offer an all-inclusive service over the entire product lifecycle for a long-lasting and successful collaboration on the basis of trust.

mk Parts



Reduce your planning time by using the "mk Parts" CAD parts library!

- Online at www.mk-group.com
- Free access to CAD data
- Simple processing with native and neutral CAD formats
- Automatic part list information for the components
- Part configuration online

mk QuickDesigner Conveyor Technology



Your conveyor at the touch of a button!

- Web-based and therefore available anytime, anywhere
- Useable on all devices without installation
- Easy to use incl. help and live view
- Quick due to predefined selection criteria
- Reliable results by direct plausibility check
- Automatically generated CAD model
- Direct offer incl. price
- Save configurations and edit later

mk QuickDesigner Guarding



Quick and easy design of your guarding!

- To download, click on www.mk-group.com/Service
- Conveniently create guarding without costly design
- Cost optimization through automatic selection of default fields
- Exporting of 3D drawings for further processing or enhancement in your CAD system

Locations

We're there where you need us



Headquarters in Troisdorf,
Germany

Every hour of downtime for you or one of your customers costs you money and reputation. Therefore, we are on your side in the planning and design phase, as well in after-sales business as a partner. Our international network of

production, sales and service sites make it possible to quickly respond to your requirements and make the service you are used to possible. Our site addresses are available on our website at www.mk-group.com.

Copyright © 2008 Maschinenbau Kitz GmbH, all rights and technical modifications reserved. Reproduction, in whole or in part, only with the expressed, written consent of Maschinenbau Kitz GmbH. Legal venue is Siegburg, Germany. Current as of 02.2015.

Information material

Our catalogs are organized by our four main business areas. Various product flyers complement our catalogs.

Browse online under www.mk.group.com through our catalogs and flyers or download them as pdf. We will be glad to send you a printed copy by mail.

mk Profile Technology Catalog



More than 250 combinable system profiles made of high-quality alloys, perfected and stability-oriented connectors, as well as a comprehensive range of accessories is available in our comprehensive 300-page mk profile technology catalog.

mk Conveyor Technology Catalog



20 different conveyor systems from belt, timing belt, chain and flat top chain conveyors to roller conveyors are available in our 320+ page mk conveyor technology catalog. Our mk INOX conveyor technology flyer includes belt and flat top chain conveyors, as well as roller conveyors made of stainless steel.

mk Linear Motion Catalog



mk linear technology stands for optimal, needs-based design. Gliding assemblies, track roller assemblies and recirculating ball bearings are displayed on 130 pages. You have the choice between profile and linear guides, as well as complete linear modules.

mk Factory Equipment Catalog



Building on our profile technology, a comprehensive range of modules for individual factory equipment is on 160 pages. It includes guarding, system workstations, guard rails, treads and platforms in modular design.

Mini-CD mk E-Catalogs



The handy Mini-DVD contains all mk catalogs as PDF files.

mk Flyer



More topics are in our Flyers discussed. They are also available as an ebook, pdf or in print, like the catalogs.



Maschinenbau Kitz GmbH
Headquarters of the
mk Technology Group

Ampèrestraße 18
53844 Troisdorf
Germany

Phone +49 228 4598-0
Fax +49 228 453145

www.mk-group.com
info@mk-group.com