

AllTorque

The very latest from Twiflex Ltd. and Wichita Clutch

Featured in this Edition...

Turning, Locking &
Braking

Escalating Experience
Over 25 Years

MINExpo 2016

Bibby Grid and Torque
Move to Bedford

Genuine Wichita
Replacement Parts

Twiflex Moves to
Germany in Partnership
with Stieber



Find us on:



For more information visit
www.twiflex.com and
www.wichita.co.uk
or call us on 0123 350311



Scan to download
the interactive version of
the AllTorque

Bibby Grid and Torque Move to Bedford

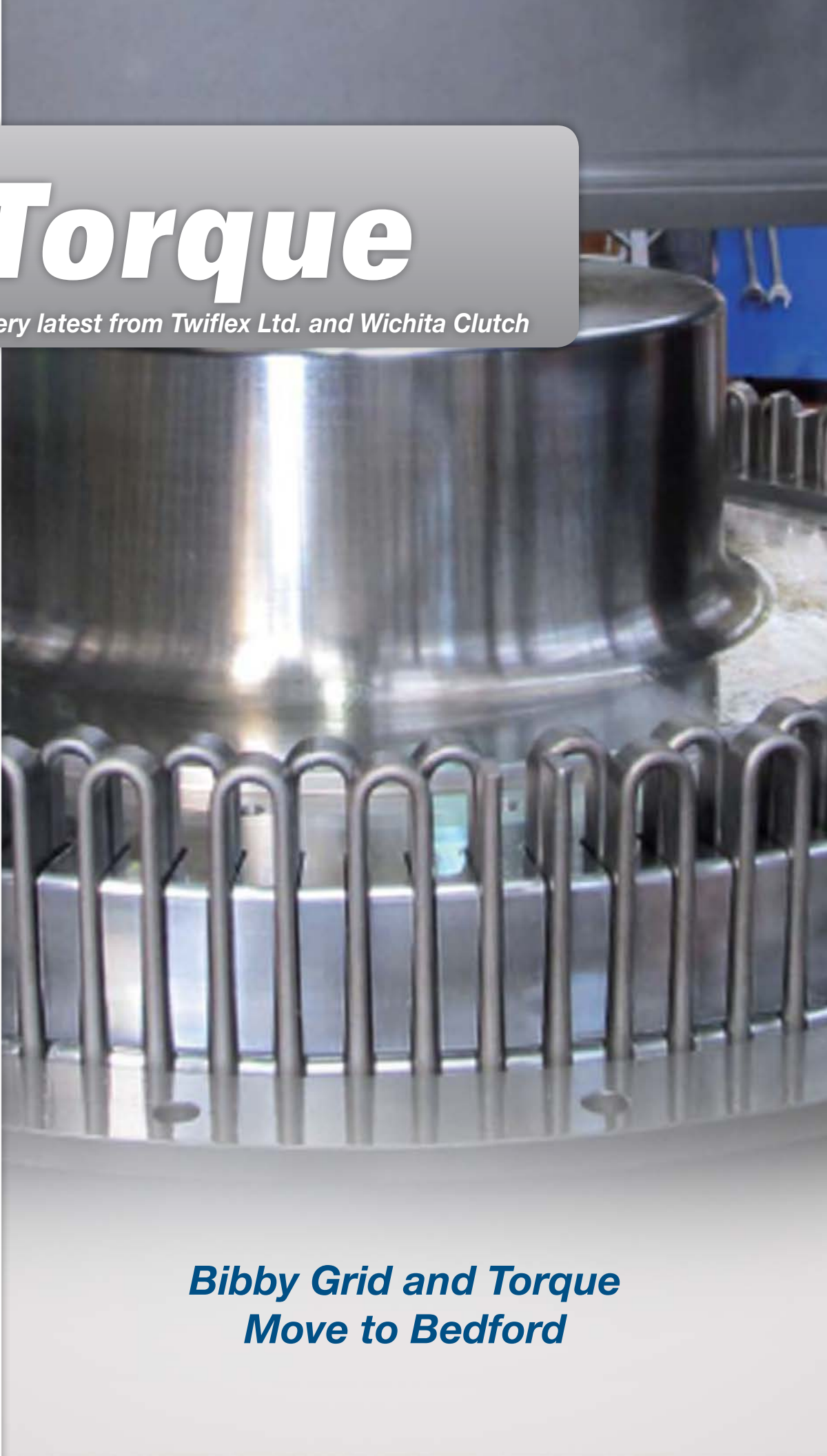

TURNING, LOCKING AND BRAKING

The launch of the new Twiflex TLB (Turning, Locking and Braking) system cements the company's place as a world leading supplier of brakes and clutches to the marine sector. Twiflex, part of the Altra Industrial Motion Group, has demonstrated via the TLB its wide ranging expertise in designing and manufacturing specialised solutions for controlling propeller shafts at sea, in port or during maintenance.

Initially designed in-house by Twiflex specifically for an ice breaking vessel, new development work has seen the system evolve to service a wide range of marine propulsion requirements. The TLB centralises three separate operating functions (Turning, Locking and Braking) in one multi-functional modular system, offering versatility at sea via innovative and compact design.

Modular design enables each function to operate individually or in conjunction, as well as the operating modes of the full TLB system. The TLB has been initially based upon five standard brake disc dimensions, with the system offering continuous turning torques of up to 454 kNm and, dependent on configuration, the option of an alternative indexing system. Coupled with a compact power unit with a control panel or remote pendant, end users can affect control with ease.

The TLB was first launched at SMM Hamburg in September and received much acclaim from attendees. To discover the performance of the TLB for yourself, scan the QR code below to watch the Turning, Locking and Braking Video from Twiflex Limited.

Twiflex was joined at the show by its sister company, Wichita Clutch, in order to highlight a range of solutions developed to achieve efficient and reliable maritime applications. Via Altra's global support network and over twenty established brands within the group, Twiflex and Wichita engineers are able to develop complete power train solutions with individual components designed for seamless integration.

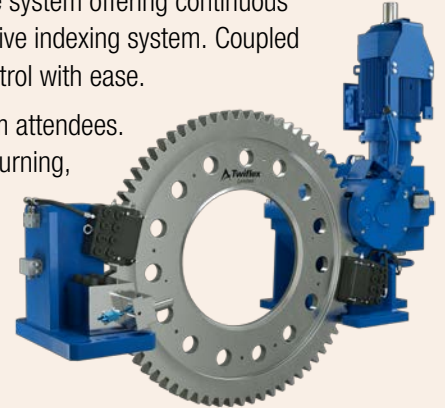

Scan to watch **Turning, Locking and Braking Video** by Twiflex Limited

ESCALATING EXPERIENCE OVER 25 YEARS

What could travel to the moon and back without leaving the station? Funnily enough, the answer is the mass transit escalator.

Escalators such as those installed at the now 24 hour London Underground are the juggernauts of the moving staircase genre, weighing in at up to 40 tonnes, measuring up to 60 metres in length and incorporating approximately 15,000 individual moving parts. Mass transit escalators operate at increased speeds compared to shopping centre equivalents, an increase of 0.25m/s to be exact, and are expected to work 24 hours a day, 7 days a week throughout their working life - which can extend up to 40 years.

The 430 escalators operating on the London Underground Network aid passengers to complete 1.3 billion journeys every year and are expected to operate virtually constantly – so reliability and performance are paramount to ensuring smooth service and safe, happy commuters.

These demands are specifically important to an escalator's braking system, especially when it is noted that the system is also integral to communication, fire detection and suppression systems. Escalator brakes must bring the staircase to a smooth halt under conditions such as power failure, emergency stop signals or mechanical problems. Furthermore, the brake must hold the escalator in place until it is restarted, without a reliance on external power. No easy task when considering the overall weight of escalators and the potential presence of multiple passengers on them.

Twiflex has over 25 years' experience supplying these braking systems to major OEM escalator manufacturers. Twiflex also delivers the associated hydraulic control systems, expertise which has seen the company work with London Underground Limited and its contractors as part of its ongoing overhaul and upgrade programmes, keeping the network and the city moving.

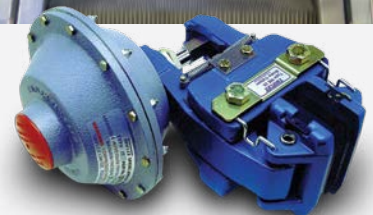
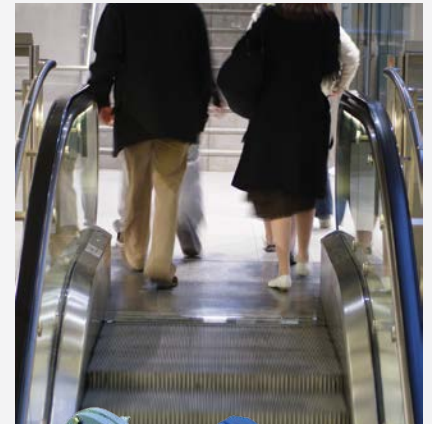

MINE EXPO EXHIBITION – DIGGING DEEP IN LAS VEGAS

Twiflex showcased some of its largest brakes to the world at Mine Expo 2016 in Las Vegas, receiving an overwhelmingly positive reception from attendees. The VMS-DP and VMS 3 SPS models were on show, weighing in at 3 tonnes and almost a tonne and a half respectively.

These models are utilised in a wide range of applications, but most predominately in mining. Typically, the brakes will provide braking and holding on grinding ball mills, due to their reliability, versatility and the tremendous stopping power they can provide.

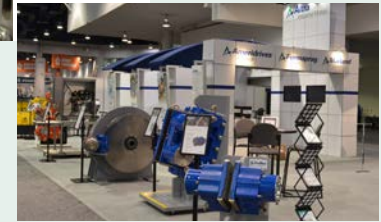
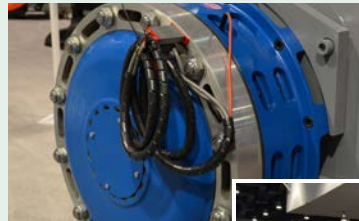

BIBBY GRID AND TORQUE MOVE TO BEDFORD

In 2016, production of the Bibby Grid and Torque products moved from Bibby Turboflex in Dewsbury to Twiflex in Bedford. It required careful preparation to facilitate the assimilation of these products, building in better planning, production and assembly processes, allowing us the chance to improve upon how these products are made, and by focusing on other aspects costs and resourcing, to deliver them faster and at better price to the customer. In October we assembled the biggest Bibby unit thus far at the Bedford site, the R734H Type coupling, weighing 2.5 tones, with a diameter of 1.2 meters. Twiflex is looking forward to continued success with the Grid and Torque product lines after this transition.

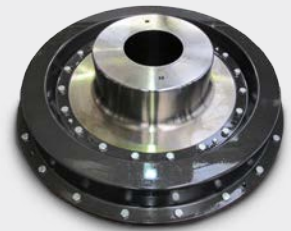

GENUINE WICHITA REPLACEMENT PARTS

When a steel air-tube holding plate on a bending brake press cracked off a non-genuine clutch, the facility manager of the metal forming plant affected contacted Wichita Clutch to provide a more reliable clutch replacement. The failure at the high volume production facility resulted in costly downtime, so it was imperative to replace the clutch quickly so that the production schedule could be resumed.

Press braking is a very demanding application due to the extreme forces involved, so Wichita Clutch delivered a heavy-duty Low Inertia (LI) air-tube disc clutch to serve the machine. Perfectly adapted for high cyclic applications, Wichita LI Clutches are designed for end shaft mounting onto bearing supported flywheels or gear wheels.

Wichita LI Clutches are manufactured to be free from the adverse effects of centrifugal force and self-energisation, with developed torque in direct proportion to air pressure applied. The clutch combines all the most innovative features of a disc type clutch, coupled with the benefits of direct air engagement, which can be simply achieved by applying air pressure through a direct axial pressure application by utilising compressed air in a composition full-circle tube.

Smooth engagement without noise, shock or impact plus complete release in a fraction of a second are all inherent operation benefits of Wichita clutches. This fraction of a second release is achieved thanks to the small volume of air required for operation. During acceleration applications, the clutches may be slipped moderately in order to control the rate. When moving large inertia loads via an electric motor, a controlled smooth slip-start from the clutch can keep power levels within acceptable parameters. Heat generated during slipping or heavy operation is dissipated by the integral centrifugal blower design of the component. Wichita OEM units and spares undergo rigorous testing to ensure reliability and longevity.



Some people may not recognise Twiflex as a brand in Germany, due to the long standing relationship with Deutsche van Rietschoten GmbH, coupled with the elephant brakes brand. Historically these products were always designed and manufactured by Twiflex in the UK, then sold to and distributed by DVRH in Germany; this relationship has now changed, as Twiflex moves forward. The full Twiflex company history makes for interesting reading and can be found on our website at: www.twiflex.com/company/history.

As the brand continues to grow, selling direct through Twiflex Germany allows us to continue to expand our stocked product offerings and further reduce lead times on engineered solutions. Twiflex is world-renowned brand and establishing Twiflex Germany is helping to grow its popularity in one of the world's strongest manufacturing economies. Stiebers' close relationship with Twiflex ensures that even the most complex, unusual or customised braking applications can be catered for - direct from the manufacturer.

Twiflex Germany can also provide local application engineering support and package bespoke mounting equipment and ancillary components to meet customers' exact specifications. Twiflex Germany is supplying the brakes as part of a comprehensive package that includes design and selection support, provisions of discs and hubs, mounting brackets and other associate parts of a complete braking system. As a result, the purchase and installation of brakes for customers in the region is greatly simplified.

Twiflex brakes are further bolstered by the wide ranging international sales, logistics and service capabilities of the wider Altra group, the world's premier manufacturer of industrial clutches, brakes and couplings. Therefore, customers can expect continuous support, wherever their products may be installed. This close business relationship means that consistent assistance is available for even the most customised systems, all from one central source.

Uwe Walter, Managing Director of Stieber Germany, expands: "With this new offering, we are answering the needs of our customers in Germany, who continually seek to streamline procurement and improve the agility and responsiveness of their operations. It is also very satisfying that we have put such a useful engineering function at the heart of German manufacturing, coupled with our goal to continue to provide employment for skilled people."

Tony George, Product Manager at Twiflex, adds: "This new arrangement with Stieber is a great example of the way the Altra Industrial Motion group is working to improve service and support for customers worldwide. Now our customers in Germany will be able to benefit from a shorter supply chain and easier local access to product expertise."

Twiflex products have been utilised in some of the most demanding power transmission applications around the world for over 70 years. Famous world-wide for the quality of its products, Twiflex incorporates innovation in product design in order to increase reliability and simplify assembly and maintenance.

Why not take a look at the Twiflex Germany website:

www.twiflex.de

To get in touch with Twiflex Germany by phone, please call: **+49 (0) 6221 304719**

Or email using the following address:

twiflex-sales@stieber.de

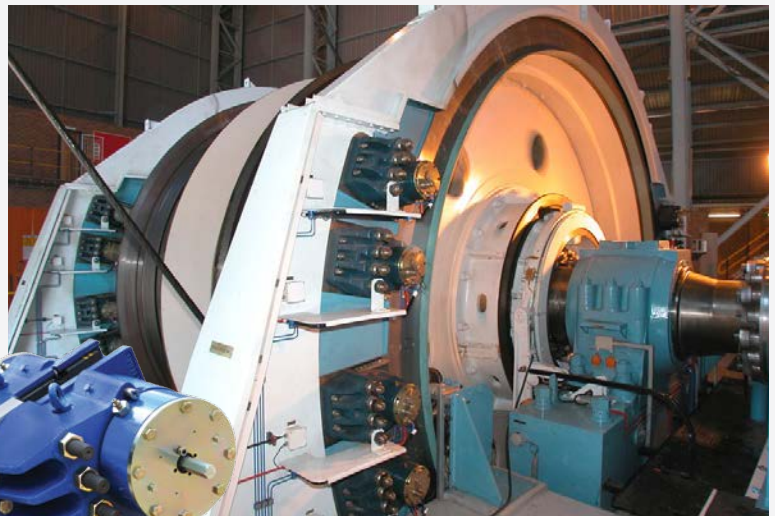

Contact us:

www.wichita.co.uk

Amphill Road
Bedford MK42 9RD - UK
+44 (0) 1234 350311
Fax: +44 (0) 1234 350317