

**DELTA MEMBRANE SYSTEMS LTD**  
**FLOOD RESILIENCE**



# CONTENTS

---

A DELTA SOLUTION	03
SERVICES	04
WHAT IS A FLOOD?	05
WHAT IS A FLOOD RISK?	06
FACTS ABOUT FLOOD RISK	07
ASSESSMENT OF FLOOD WATER INTO BUILDINGS	08
BS85500:2015	09
WHAT IS FLOOD RESILIENCE?	10
SOLUTIONS	11
RESISTENCE, RESILIENCE & RECOVERABILITY	12
RESISTENCE AND RECOVERABILITY	14
DELTA'S DESIGN PRINCIPLES	16
DELTA PRODUCTS	17

# A DELTA SOLUTION

Delta Membrane Systems Limited is the leading Type C Cavity Drain Membrane Manufacturer in the United Kingdom. Our extensive range of flood resilience, waterproofing and damp proofing products are suitable for flood resilience projects, structural waterproofing and basement drainage (for new build and existing structures), public sector commercial and domestic.



## HOW CAN RESISTANCE AND RESILIENCE HELP?

Whilst protecting a building from being flooded is not cheap, taking steps to protect your home from flooding may enable you to continue living in your building after a flood event, continuing business and services and obtain insurance at a more affordable rate.

Resistance and resilience measures can avoid the need to claim on insurance if you are flooded, or reduce the value of any claim made. Insurers will take flood resilience measures into account when providing insurance to large commercial and public sector customers. For homeowners, specialist insurers will take account of resistance and resilience that are installed to reduce the effects of flooding.

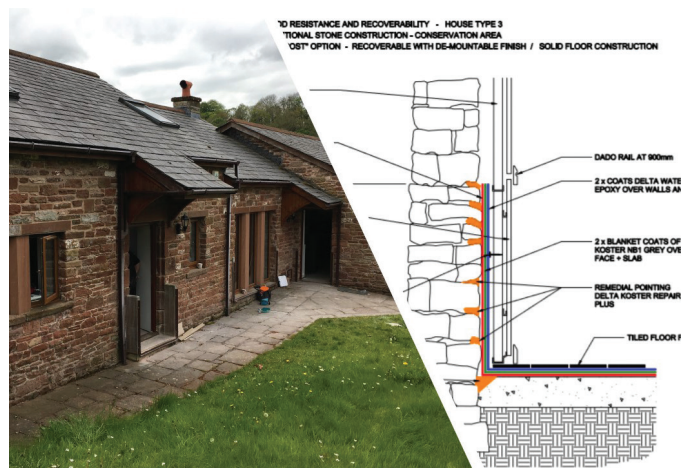
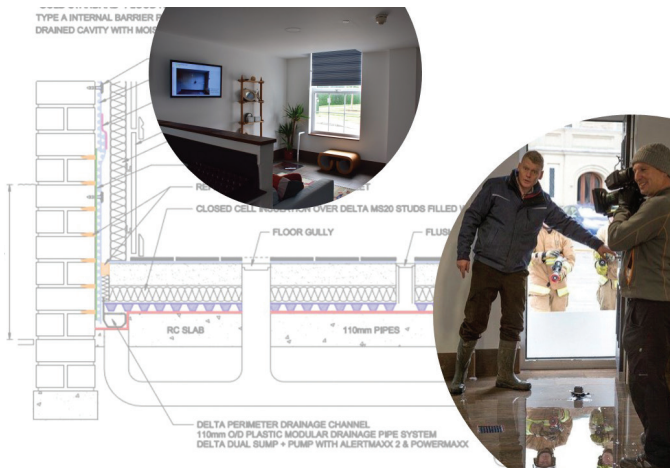
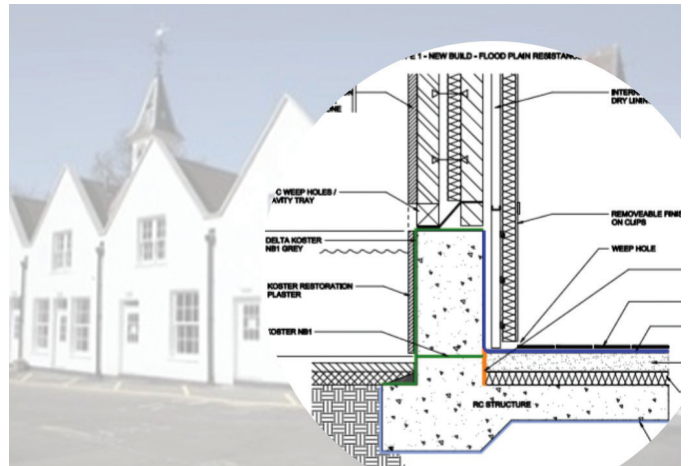
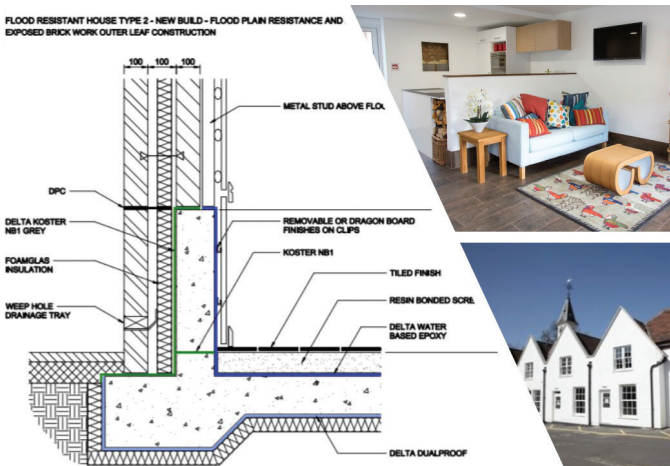

# SERVICES

Delta Membrane Systems Limited provides a full range of waterproofing and flood resilient solutions suitable for all new, retrofit and refurbishment construction. With over 125 years of manufacturing experience Delta is an impeccable partner on every project. Our skills have been mastered through experience in the waterproofing industry. Delta's trusted Technical Team will offer assistance from concept to completion. Our hands on approach and knowledge is what sets us apart.



## DESIGN SUPPORT

- Architecture knowledge
- Concept and waterproofing solutions
- Advice on design and best practice
- Custom solutions, as each project is unique in requirements
- Qualified CSSW staff (named on the Waterproofing Design Register)



## SPECIFICATION SUPPORT

- Detailed drawings including CAD
- Watertight and locking down structure concepts
- Specifications
- BIM
- NBS Plus
- RIBA Product Selector



## SITE SUPPORT

- Training and guidance offered at every step
- Technical Team attendance at site meetings
- Knowledge and experience
- Troubleshooting solutions



# WHAT IS A FLOOD?

“An overflow of a large amount of water beyond its normal limits, especially of what is normally dry land”

(Oxford English Dictionary)

“A covering by water of land that is not normally covered by water”

(EU Floods Directive 2007/60/EC)

## TYPES OF FLOODING

1

### RIVER FLOODING

River flooding, also known as fluvial flooding, occurs when the capacity of a rivers channel is exceeded as a result of intense or sustained rainfall across the catchment.

2

### GROUNDWATER FLOODING

Groundwater flooding occurs when the water table rises up to the surface during a prolonged wet period. Low lying areas, areas near aquifers and properties with cellars or basements are more likely to experience groundwater flooding.

3

### SURFACEWATER FLOODING

Surface water flooding occurs when the volume of rainfall is unable to drain away through the drainage systems or soak into the land and instead flows over land. Blocked drains and sewers can increase the risk of surface water flooding as the water has nowhere to go.

4

### COASTAL FLOODING

Simply put, a coastal flood is when the coast is flooded by the sea. The most common cause of coastal flooding in the UK is storm surges, where the storm wind pushes the water up and creates high waves.

5

### SEWER FLOODING

Most sewerage flooding incidents are the result of overloaded sewers following heavy rainfall or blockages caused by misuse of the sewerage system such as flushing unsuitable items down the toilet.

6

### RESEVOIR FLOODING

Reservoir flooding can be similar to river and surface water flooding if the water escapes slowly. However, in the unlikely event of a dam wall failing, a large amount of water could escape. It could happen with little or no warning and you may need to evacuate immediately.

7

### BURST WATER MAINS

The signs of a burst water mains pipe are fairly instantaneous and obvious. Water main breaks usually result from external corrosion of the pipe. Extreme weather changes can cause the ground to swell and contract, placing excessive pressure on the water mains, causing any weakened pipe to break.

# WHAT IS A FLOOD RISK?

Flood risk takes into consideration the harm that a flood actually causes. It is a combination of the probability (likelihood or chance) of an event happening and the consequences (impact) if it were to occur.

Being flooded is an appalling experience. Witnessing helplessly, as everything you have worked so hard for is thrown into a skip and the loss of precious sentimental items is completely devastating.

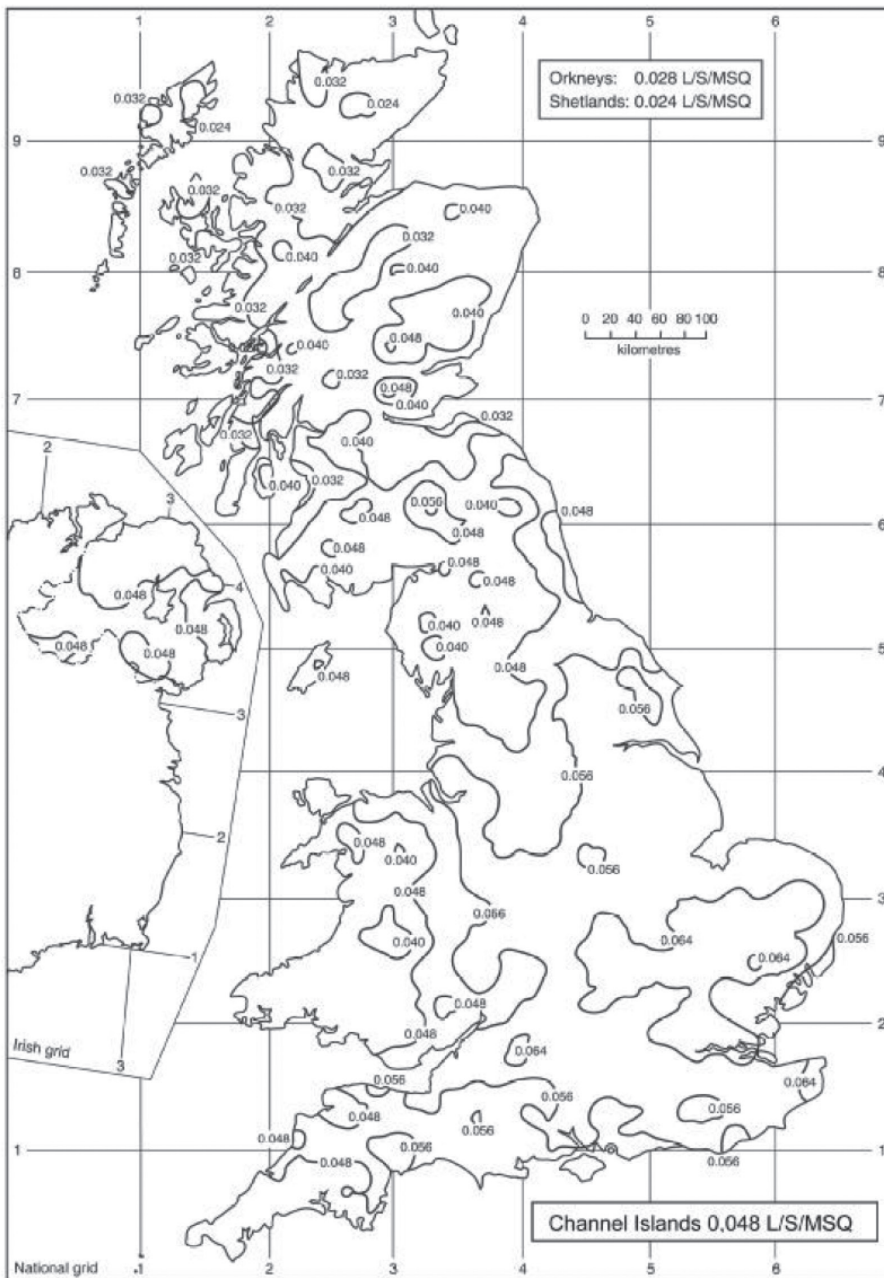

## HOW DO I FIND OUT IF MY HOME IS AT RISK OF FLOODING?

Investigate whether your property is at risk of flooding from a number of sources, using the maps provided by the relevant agency for your part of the United Kingdom. These are:

### ENGLAND

[http://maps.environmentagency.gov.uk/wiyby/wiybyController?ep=maptopics&lang=\\_e](http://maps.environmentagency.gov.uk/wiyby/wiybyController?ep=maptopics&lang=_e)

### WALES

(in English or Welsh) - <http://naturalresources.wales/our-evidence-and-reports/maps/flood-risk-map/>

### SCOTLAND

<http://www.sepa.org.uk/environment/water/flooding/flood-maps/>

### NORTHERN IRELAND

<http://www.infrastructure-ni.gov.uk/articles/what-flood-maps-n>

The misery of having to move out of your home and into alternative accommodation for months, sometimes years, has a far-reaching and long-term consequence.

A flood will take everything you have, including items of no value to anyone else.

By choosing the relevant map and entering your post code the map will indicate the areas at risk of flooding, for example: in England, the dark blue shading for the highest risk, lighter shades where there is some risk and no shading where the risk is very low (meaning that each year, this area has a chance of flooding of less than 1 in 1000 or 0.1%). Click the map at the location of your house and a summary of flood risk at that area will be provided. The risk is graded as 'very low', 'low', 'medium' or 'high'.

# FACTS ABOUT FLOOD RISK

There are 9 Factors which should be considered when deciding on flood recoverability to your property these are:

## FLOOD DEPTH

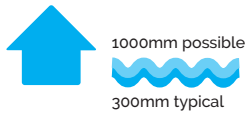

Consideration to Flood Depths should be factored into your decision making on flood protection measures. What are the expected depths? Low depths, for example 100mm, are unlikely to put lives at risk but water damage to buildings and contents may be significant. High water depths, for example 1m, may threaten safety/lives and cause extensive damage to buildings. Differences in water levels greater than 900 mm across walls can cause structural damage through hydrostatic pressure.

## FLOOD DURATION



Flood Duration is the time that flood water is expected to remain in your property. Temporary flood defences may successfully keep water out if flooding is expected to last for a short space of time (a couple of hours). Longer flood durations will have direct impact on deterioration of materials, components and elements resulting in immediate change of their form and properties without returning to their previous condition after drying.

## FLOOD ONSET



What is the time flood water takes to reach your property from its source? Flood Onset should always be factored in when deciding on flood protection measures. Flash Flooding (short onset flooding) is particularly dangerous as there is little time to protect a building or get people to safety.

## FLOOD ANNUAL PROBABILITY



Different approaches to flood protection may be required depending on how likely flooding is expected. Flood annual probability measures the chances of flooding over the course of 1 year. Frequency, speed and depth of future flooding events are unpredictable. The most effective design should combine elements of water exclusion and eventual water entry.

## SOURCE

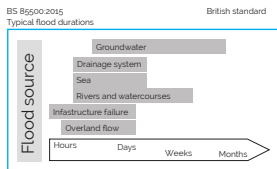

Full consideration to the Source of flooding is a process within Flood Resilience design. Is a building/structure prone to ground water flooding or coastal flooding or both? These factors will impact on recoverability options in protecting a structure, with overall strategy designed to mitigate against several sources.

## AVAILABILITY OF WARNING



Flood warnings are a highly important adaptive measures in protecting a property from flood damage. There are three flood warnings codes: Flood Alert (be prepared), Flood Warning (take immediate action, flooding is expected) and Severe Flood Warning (Sever flooding/danger to life).

## SPEED OF RISE

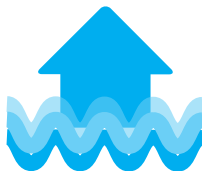

Urbanisation increases flood risk, because towns and cities have more impermeable surfaces. Flooding tends to be caused in the United Kingdom by heavy rainfall: the faster the rainwater reaches the river channel, the more likely it is to flood. Improvement of integral water resilience of a building's physical structure, whilst making internal finishes resilient, inorganic and quick demountable/replaceable and amenable to sanitisation will speed up re-occupation time.

## VELOCITY

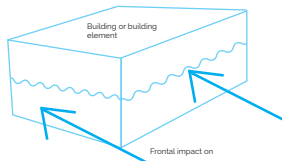

Velocity is the speed at which floodwaters move/flow. It is usually measured in feet per second (fps). Flow velocities during river flooding events can easily reach 5 to 10 fps and in some situations, may be even greater. Expressing velocities in fps is common in floodplain studies and engineering analyses. Direct structural damage can be caused by the depth, duration and velocity of flood waters, including debris impact.

## EASE OF EVACUATION



Be Prepared. Have A Evacuation Plan. Floods can strike quickly and without warning. In the case of a flooding event, it's important to know where to go, how to get there and what to. Discuss what to do in an evacuation with everyone in your family. Know where you will go if an evacuation is called.

# ASSESSMENT OF FLOOD WATER INTO BUILDINGS

Around 5.5 million buildings in the UK are in danger of being flooded. That's approximately 15% of properties built near to rivers, the sea or areas of extreme surface water run-off caused by local ground conditions – the latter of which are often in places that aren't physically close to open water.

Accurately assessing your flood risk will offer ways to assess how flood water will enter a structure.

There are a number of routes in which floodwater can enter a property. Potential routes for entry of flood water include:

- party walls from neighbouring properties, garages and conservatories
- gaps around pipes and cables that pass through walls and floors. The pressure created by a flood event can reverse the flow in drains and pipes, causing water to back-up and enter a home through sinks, toilets, washing machines etc. One of the most unpleasant side effects of a flood is the potential release and circulation of raw sewage inside a building
- cracks in brickwork
- at the damp proof course
- through sub-floor ventilation
- through permeable brickwork
- through weathered or damaged mortar
- through gaps and joint sealants around doors and window
- through unprotected doors and windows
- seepage through the ground and floors without effective damp-proof membrane
- through floors of basements and cellars
- Airbricks are potentially vulnerable.

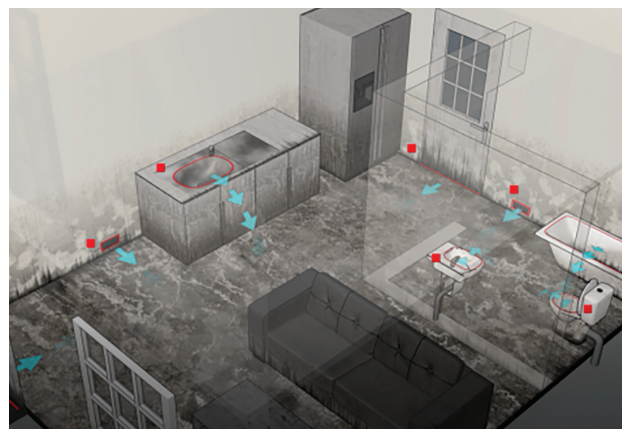
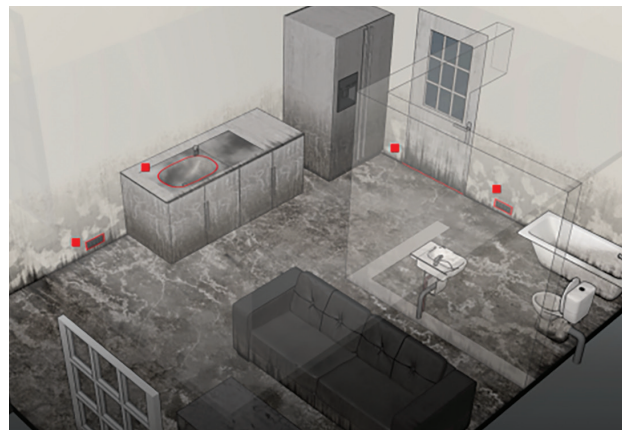



# BS85500:2015

## WHAT ARE BRITISH STANDARDS

Standards define best practice.

A standard is an agreed way of doing something. It could be about making a product, managing a process, delivering a service or supplying materials – standards can cover a huge range of activities undertaken by organizations and used by their customers.

Standards are the distilled wisdom of people with expertise in their subject matter and who know the needs of the organizations they represent – people such as manufacturers, sellers, buyers, customers, trade associations, users or regulators.

## WHAT DOES A STANDARD DO?

Standards are knowledge. They are powerful tools that can help drive innovation and increase productivity. Standards within the Construction Industry enhance consumer protection and confidence.

## THE BENEFITS OF USING BRITISH STANDARD 85500:2015 IN FLOOD RESILIENCE

BS 85500:2015 (Flood Resistant and Resilient Construction. Guide to improving the flood performance of buildings) is the standard that has been developed to provide guidance to architects, engineers and developers on suitable materials and construction techniques for improving the resistance and resilience of buildings against flooding. It has been developed by flood risk and watercourses experts, including representatives from the Association of London Borough Planning Officers, Defra and the BRE.

## BS 85500:2015 Choice of Strategy

BS 85500:2015 offers a choice of strategies when designing a flood recoverable solution:

- Avoidance
- Mitigation
- Water Exclusion (flood resistance)
- Water Entry (flood resilience)

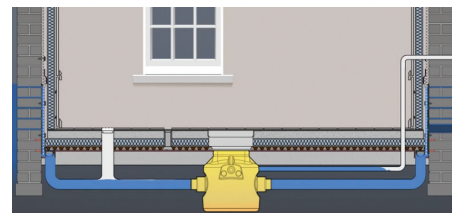
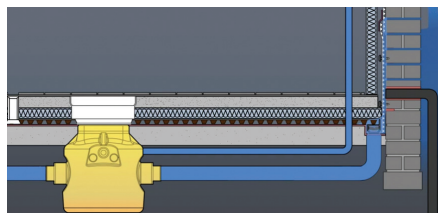
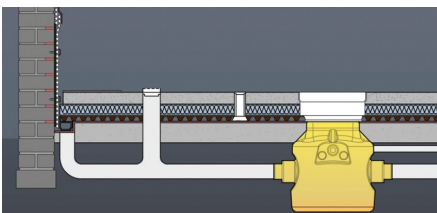

## DESIGN OPTIONS

The simplest water exclusion measure is to build the ground floor above the maximum level that any flood water is likely to reach. However, this is often impractical to structures already built and planners may not approve of a new build being disproportionately higher than neighbouring properties.

Where the potential flood level is below 600mm, there are a number of relatively simple ways of sealing off the inside and keeping a structure more or less dry. A common option is to use tanking; a continuous waterproof layer buried within the wall and floor construction that prevents floodwater from seeping into rooms.

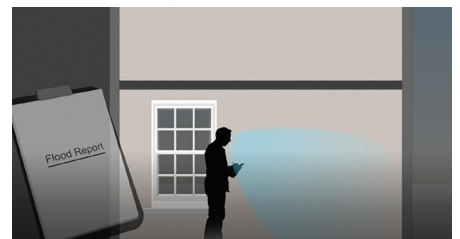

# WHAT IS FLOOD RESILIENCE?

Flood 'resistance' typically refers to products which are designed to keep water out of your structure(s). Temporary flood resistance products are those that need deploying (fitting or activating) prior to a flood event whereas permanent flood resistance products do not need activating.

Flood 'resilience' refers to measures that reduce flood damage to buildings and covers situations where water enters the structure.

## FLOOD RESILIENCE EXAMPLES

- Water exclusion
- Water entry
- Recoverability
- Cleaning and Sanitisation
- Drying Times
- Re-Occupation
- De-Mountable/Replacement
- Bespoke Products and Measures
- Situation Monitoring
- Planning for the Future

BS85500:2015 is the British Standard for Flood resistant and resilient construction. Guide to improving the flood performance of buildings.

BS85500:2015 has been developed to provide guidance to architects, engineers and developers on suitable materials and construction techniques for improving the resistance and resilience of buildings against flooding.

Developed by flood risk and watercourses experts, including representatives from the Association of London Borough Planning Officers, Defra and BRE, the standard specifically provides guidance on:

- Identifying when building flood resilience and resistance are appropriate
- Reducing the impacts of flooding from all sources
- The use of suitable materials and construction techniques

BS85500:2015 applies to all building construction including new builds, extensions and retrofits.

BS85500:2015 states that the most successful design strategies when planning resistant and resilient construction (for water entry and water exclusion) is to plan for both.



## WHAT IS FLOOD RESISTANCE?

Flood Resistance is construction of a building in such a way as to prevent or minimise flood water entering the building and damaging its fabric.

## WHAT IS FLOOD RESILIENCE?

Flood Resistance are measures that can be incorporated into the building's fabric and/or fixtures and fittings that can be installed to reduce the consequences of flood water entering the property.

## WHAT IS FLOOD RECOVERABILITY?

Flood Recoverability are measures which offer Flood Resistance and Resilience to enable fast recovery of a building after a flood event.

# SOLUTIONS

Since the BRE's success at building a flood resilient house, the flood resilience industry has witnessed rapid growth. The BRE's Flood Resilient Home was commenced following the "Bonfield Report" or The Property Flood Resilience Action Plan – a plan to enable better uptake of resilience measures for properties at high flood risk.

In 2015/16 we experienced the highest rainfall on-record over a single day, building on sustained rainfall over a period of weeks, leading to the highest river flow levels ever recorded.

This resulted in a huge impact upon people, homes and businesses, with over 17,000 properties flooded and the cost of the damage caused expected to reach £1.3bn.

The Insurance industry has been closely monitoring the progress of flood resilience with The Royal Institute of British Architects (RIBA) publishing a new report outlining what the Government needs to do to help create homes and communities that are resilient to flood damage.

The BRE flood resilient home has been flooded and recovered numerous times since its launch in March 2017 and has proven its quick recovery time. Incorporating this approach to flood resilience will see thousands benefit.

Structural Waterproofing expert's, such as Delta Membrane Systems Limited's knowledge-based experience is invaluable in bring tried and tested materials and approaches into flood resilience measures.

Flood resilience is a DEVELOPING SCIENCE and a market opportunity for 'Joined up Thinking' through better thinking, we can evolve solutions, we can build on service and ultimately a better future for everyone.

Delta Membrane Systems Limited have been an active member of member of the PCA Flood Resilience Group and have cemented their knowledge in flood resilience by joining Mary Dhouau on the Cumbria Resilience Showcase Project.

Delta's Technical Team's meticulous approach to flood recoverability incorporating structural waterproofing solutions, has seen projects meet insurance industry standards (meaning home and business owners) will be able to insure previously uninsurable properties.

Delta Membrane Systems were awarded the PCA Best Practice Award 2017 for their "Innovation" in flood resilience, were award an ASUC award for "Innovation and Sustainability" and were named as finalists four times in the Construction News Specialist Awards 2018 and the Ground Engineering Awards 2018 meaning that all sectors are aware of changes and that these changes need to be implemented now.

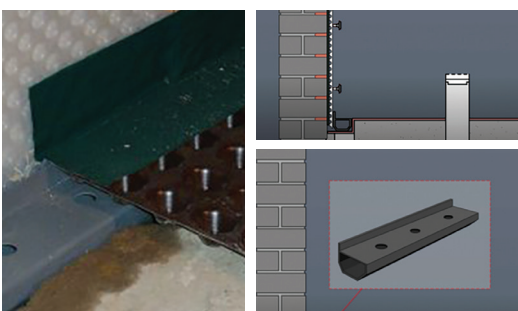
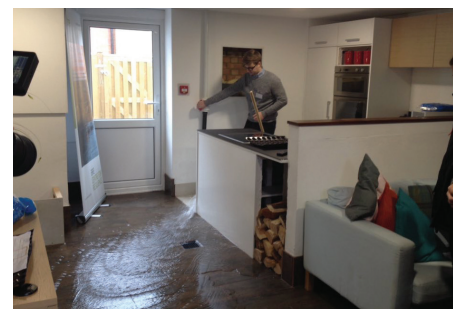

# RESISTENCE, RESILIENCE & RECOVERABILITY



## SPECIFICATION

- Delta MS500 Wall membrane
- Delta MS20 Floor membrane >Qwik Seal Fixing Plugs
- Delta Double-Sided Tape
- Delta Corner Strip Tape >Delta Drainage Channel
- Delta Dual V3 Sump Pump
- AlertMaxx High Level Alarm
- PowerMaxx Battery Backup
- Polysil TG 500

**Client:** BRE (Building Research Establishment)  
**Sub-Contractor:** Proten Services

## OVERVIEW

#Floodaware – flooding is ever present in the news, we are seeing homes destroyed and families left homeless on a frighteningly regular basis. An estimated 5.2 million homes are at risk from surface, river and coastal flooding; over 400,000 are classed as 'extreme high risk'. Both the construction and insurance sectors

have sought to find innovative ways to prevent flood damage. Whilst homes already constructed in a flood prone area need adapting, developers need to take flood prevention measures into consideration when commencing new developments.

In 2016 Delta Membranes Systems were delighted to attend a series of meetings chaired by the BRE to discuss Flood Resilience measures in a bid to reduce the suffering experienced by thousands of home and business owners whilst taking into account the vast cost implications to home owners and insurers in making properties more resilient in the face of flooding.

Delta Membrane Systems were thrilled when the BRE proposed that in order to convey this message to home & business owners, construction professionals and insurers alike, they suggested one of their properties, a Victorian terrace house to be used for the purposes of installing flood resilience measures and utilising

technology already in existence and adapting it to provide a robust solution. The event was sponsored by the PCA "Property Care Association" and Steve Hodgson CEO was in attendance.





## METHODOLOGY

Delta Membrane Systems Ltd's Technical Director, David J Symes produced a specification with the assistance from John O'Brien, BRE Associate Director Construction Innovation and Delta registered installers Proten Services Ltd.

The specification for resilience was simple, using the same technology Delta have used for many years in Basements or below ground situations with additional consideration as to how we could adapt this to work in flood situations. In addition to flood water entering through openings to properties (such as doorways, air bricks and windows) buildings also suffer, in some cases with ground water rising up through flooring, causing extensive damage.



## HOW DOES THE TECHNOLOGY HELP US?

Flood water enters a home causing extensive damage to the fabric which leads to Insurers appointing a loss adjuster to assess the extent of the damage and the claim.

The strip out begins and follows with the implementation of dehumidifiers to dry out the structure, this takes many months and Insurers bear huge financial burden with not only this process but the process of reinstatement costs and providing alternative accommodation for their clients, the BRE states that masonry under typical conditions will dry out at a rate of 1" per month per thickness of substrate.

Flood water also contains contaminants which require the walls and floor to be sterilized.

In order to significantly reduce downtime, a Delta membrane (Delta MS500) can be fitted to walls, as demonstrated within the BRE test house. This is a HDPE extruded sheet, offers a dimpled effect, therefore providing an immediate barrier against the effects of slats and contamination allowing fast track reinstatement at the same time allowing for walls to dry. The same process can be used where there is a solid floor, a solid floor can be overlaid with Delta MS20, also demonstrated in the BRE test house which is a 20mm extruded sheet. We suggest installation prior to the inclusion of finishes such as insulation and screed. In short the walls and floor have been lined with a cavity drain membrane which provides an air gap.

Secondly we make the structure more resilient by installing a Delta perimeter drainage channel rebated into the floor, this deals with ground water which may rise through the floor. The drainage channel collects water beneath the floor membrane and immediately evacuates it to the Delta packaged pump station which houses two submersible pumps, the lower end of the spectrum a Delta pump will

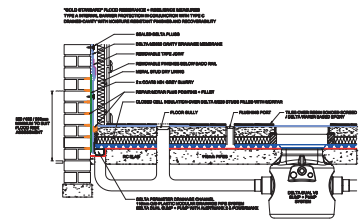

evacuate 2 litres per second per pump so a total of 240 litres per minute. Alternative pumps are available that will evacuate 6 litres per second each.

With a further modification 110mm standard underground pipework is laid within or beneath the structural slab and turned up 90 degrees to finish flush with the floor finishes which can be located in unobtrusive locations covered with a floor grill (as installed in the BRE flood house). This will pick up water that may bypass flood gates which should be installed in conjunction with the system and immediately evacuate it reducing damage. Floors are typically tiled, in mapped areas after flooding to reduce damage and other products can be installed such as waterproof insulation and plasterboard and screeds.

## CASE STUDY RESULTS

Flooded by Hertfordshire Fire Department for BBC1 Countryfile, the Flood house superseded expectations. The property highlighted it was capable of both resistance and resilience.

The Flood House project has been deemed a great success and showcases to contractors, insurers and householders alike that resilient repair isn't a great challenge or difficult and a regular practice/necessity for properties in areas at high flood risk.

All the Delta products were donated to the BRE and with our thanks to Packaged Pump Stations 'PPS' Managing Director, Ian Davis.



# RESISTENCE AND RECOVERABILITY

## SPECIFICATION

- BS 85500:2015
- Koster KB Flex
- Koster Repair Mortar Plus
- Koster FSH Joint sealant
- Delta Epoxy
- Koster Polysil TG 500

## OVERVIEW

The idea behind the Flood Resilient Showcase Project was to use products and materials that will try to keep water out of properties prone to flooding. In a flooding event that is less severe, those products (all of which have been tested to a high specification) are expected to reduce water ingress. It is acknowledged that when flooding is severe, these products may well be overtopped. The showcase highlights what can be done to manage the residual risk.

The Flood Resilient Showcase Project sought to adapt properties by using differing interventions to reduce the amount of damage that flood water can do when it enters a property.

This approach will enable the property owners to #getbackinsooner.

At the core of the Flood Resilient Showcase Project is the real-life demonstration of flood installation measures at three properties in Cumbria led by Mary Dhonau, Chief Executive of the Know Your Flood Risk Campaign.

Edenside Barn is a real-life demonstration property in the Cumbria Flood Resilient Showcase.

Edenside Barn is a private dwelling/barn conversion, located on idyllic farmland close to the banks of the river Eden, in the picturesque Eden Valley, Cumbria. The River Eden flows through the Eden District of Cumbria, on its way to the Solway Firth.

The North Pennines is designated as an Area of Outstanding Natural Beauty (AONB). At almost 770 square miles (2,000 km<sup>2</sup>) it is the second largest of



the 49 AONBs in the United Kingdom

Edenside Barn has periodically, suffered with flooding when the river Eden has bursts its banks. Following the devastation of storm Desmond in 2015/2016 Edenside Barn was flooded, leaving it uninhabitable and the owners having to seek alternative accommodation.

Mary Dhonau and Adler and Allen, in conjunction with Aquobex, were project managers in this resilience showcase project.

Aquobex Flood Management Solutions were appointed as consultants on the flood resilient design and inclusion of products within their range.

Following successful collaboration with Mary Dhonau on flood resilience projects and Aquobex, Delta Membrane Systems Limited were asked to design a robust, resilient and recoverable solution incorporating their products on this project.

## METHODOLOGY

This project required a resilient and



recoverable solution. We expect this property to experience future flooding events.

Delta's design allowed for water exclusion and water entry. Our design incorporates guidance given in BS 85500:2015 Flood Resilience in Buildings, which plans for both water exclusion and water entry.

Delta Registered Installer's Peter Cox Limited, volunteered their time to install Delta products on this project. Delta Registered Installers are an accredited national network of independent professional installers. They are not employed by Delta Membrane Systems Limited but are strictly vetted and monitored by us to assess their levels of competence and performance.

Delta's design sought to provide continuity of the internal system to the external flood barriers to create a water tight seal to the property.

Prior to application at Edenside Barn, Delta's water-based Epoxy was tested at Aquobex's testing facilities.

Aquobex operates a premier test facility dedicated to PAS1188-1 and FM2510 (testing of flood protection products). It is equipped to produce the necessary conditions for static water testing, current testing and with wave-makers suitable to deliver the JONSWAP wave formations specified in the standard. Aquobex's testing facilities are utilised by BSI and the BRE for flood product testing.

The structure itself consisted of solid stone walls and concrete floor slab. The Base substrate to this property was a good quality concrete floor with minimal risk of flood ingress.

The block walls and floor slab were tested for any potential leak paths. The interfaces between the wall and floor needed to offer a watertight seal to stop ingress between the slab and the wall.

The internal faces of the stone walls were coated using Polyurea, with 2 coats of Delta's water-based Epoxy over and to the existing floor slab.

Delta's water-based Epoxy worked

in conjunction with the ployeurea to provide both a barrier to water entry and a none absorbent finish.

Koster Polysil TG 500 was applied throughout as a salt inhibitor and surface hardening treatment.

## CONCLUSION

Through joined up thinking and the use of combined systems this property can be insured and is now recoverable to both flood water exclusion and water entry.

With thanks to Peter Cox Limited for their incredible assistance in this project and dedication in product installation and application. Thank you!



# DELTA'S DESIGN PRINCIPLES

Flood Resilient Design is not a single solution, concept or perspective. Its an approach to changing the built environment.

## TRIED AND TESTED WATERPROOFING SOLUTIONS

As Manufacturers of waterproofing solutions and designs we have extensive knowledge of water ingress and how it naturally performs in below ground structures, however we needed to learn about flooding, types of flooding, how floods occur and the nature of the same. The consequences of floods vary greatly depending on the location and extent of flooding and the vulnerability and value of the environments they affect. The consequences of floods vary (depending) on their location, duration, depth and speed.

Water in a flood situation performs in a very similar mannerism to how it reacts underground in basement scenarios, where we have our expertise.

## SUSTAINABILITY

Delta Membranes Systems Limited is committed to managing its direct environmental impacts in a responsible manner. We set practical targets within our business for ongoing improvements, allowing us to reduce our impact on the environment in all areas of our activities. We aim to be as efficient as possible in our use of resources and focus action on reducing waste from our manufacturing process, energy, travel, waste, water, paper and buildings. We have established a combined quality, workplace safety and environmental management system confirming to ISO 14001 and EMAS II the Eco Audit.



## SHAPING THE FUTURE

Delta Membrane Systems Limited is committed to offering training and education to develop skills and knowledge within the Waterproofing and Flood Resilience Sectors and continually promote standards within the industry.

We are hoping we can bring to the construction industry the knowledge that flood resilience solutions are available and affordable.

Delta is able to offer a comprehensive range of products that can be designed and integrated to produce a variety of solutions. These range from full flood resistance, resilience and recoverability solutions incorporating leakstopping, sealing and water exclusion combined with moisture resistant finishes, internal drained cavity membranes and pumps, to solutions encompassing leak stopping and recoverability, and finally solutions incorporating recoverability only. All bespoke

flood solutions are based upon a flood risk assessment and design rationale (BS8533:2011 and BS85500:2015) and encompass considerations given in those standards.

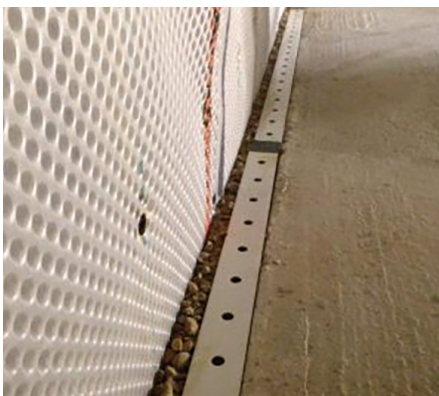



# DELTA PRODUCTS FOR FLOOD RESILIENCE AND RECOVERABILITY



## DELTA MS 500

Delta MS 500 is an 8mm studded profile High Density Polyethylene (HDPE) clear cavity drainage membrane for use on the internal faces of walls and floors as a water control & drained management system for protection of sub-ground structures against potentially adverse effects of ground water ingress.

- Type C, BBA Approved Drained Protection in accordance with BS 8102:2009
- Suitable for new, existing and retrofit projects
- Flexibility to cope in structures where movement or vibration can be problematic
- A "reversible" system, which will minimise damage to historical or heritage structures
- Resistant to chemicals, root penetration, rot proof, neutral towards drinking water
- Suitable for Flood Resilience

## DELTA MS 20

Delta MS 20 is a High Density Polyethylene (HDPE) high drainage cavity drain membrane with superior drainage capacity and compressive strength. Delta MS 20 is suitable for use as a high performance water control and management system in buildings.

- Type C, BBA Approved, Drained Protection in accordance with BS 8102:2009
- Suitable for higher volumes of water penetration
- A reversible system, which will minimize damage to historical or heritage structures
- Resistant to chemicals, root penetration, rot proof, neutral towards drinking water
- Suitable for Flood Resilience
- Resistant to Carbon Dioxide, Radon and Methane

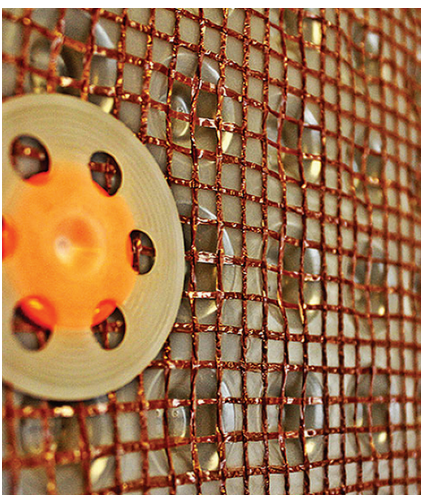
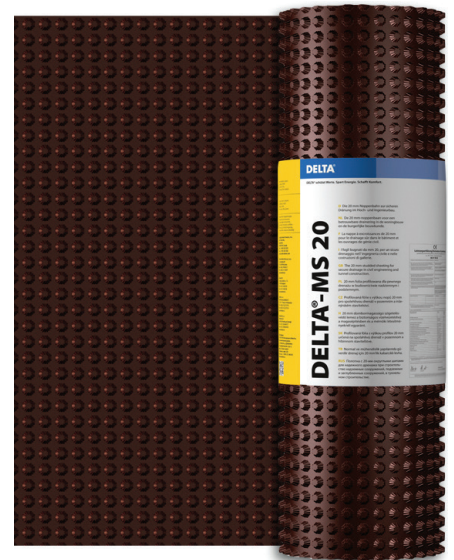

## DELTA PT

Delta PT is a High Density Polyethylene (HDPE) cavity drain membrane. Delta PT has been designed to incorporate a plastic mesh which is welded to the surface of this dimpled sheeting membrane. Suitable as an impermeable damp proofing base for plaster or shotcrete (and as a water control and drainage membrane).

- Type C, BBA Approved, Drained Protection in accordance with BS 8102:2009
- A reversible system, which will minimize damage to historical or heritage structures
- Available in 2 stud heights
- Resistant to chemicals, root penetration, rot proof, neutral towards drinking water
- Suitable for Flood Resilience
- Meets the requirement for a radon barrier

# DELTA PRODUCTS FOR FLOOD RESILIENCE AND RECOVERABILITY



## DELTA CHANNEL & ANCILLARIES

A Cavity Drainage System manages water penetration. Delta Channel is a water collection conduit designed to control water ingress. Delta Channel is bedded into a pre-formed recess/gully at the floor/wall junction and is suited for use in conjunction with the Delta Membrane range.

Our range of ancillary products work as the perfect compliment to the Delta Cavity Drain System. Allowing for application on different substrates and surfaces both sealing the membranes and detailing with any provisions whilst preventing condensation.

## PACKAGE PUMP STATIONS

The concept of a Drained Cavity System is to collect and manage any group water which breaches the integrity of a structure by managing, collecting and discharging such free water via a suitable evacuation point such as a Delta Package Pump Station. Delta offer a comprehensive range of Package Pump Stations which are suitable for the evacuation of Ground water, Surface water, Foul water and Flood water. In addition we offer bespoke chambers for larger properties. Delta's sump pumps offer complete peace of mind.



## ALERTMAXX2

The AlertMaxx2 is an intelligent high water level alarm and monitoring system which is connected to a sump pump system. The AlertMaxx2 is Wi Fi enabled and will monitor the pump stations performance. The AlertMaxx2 measures 10 different pump parameters and variables, utilising this data provided by the pumps themselves. Think of the AlertMaxx2 as a virtual pump service engineer.

- Will allow property owners time, alerting of a change in productivity of the pump system
- Detects increases in pump activity – leaking mains water pipes for example
- Performs regular health checks on pump system(s) ensuring pumps are running effectively
- Improves efficiency and reduces energy consumption

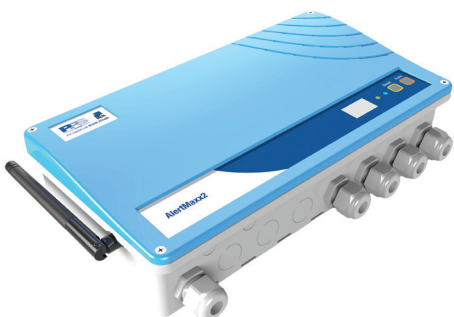

---

## ALARMS & MONITORING



### Alarms and Monitoring Systems

- High level water alarms or high level alarms are used to provide a warning. The high level alarm has been designed to detect high water or if there is an increase in volume of water entering a property.
- The purpose of the high level alarm system is to monitor and send an audible and visual alarm to property owners.

---

## BATTERY BACK-UP

With a Battery Back-up, peace of mind is a standard. Our reliable Battery Back-up will keep your pumps running during power failure, ensuring your package pump station remains working. Our Battery Back-ups are leading the industry in performance.

- Specifically design for sump pump application
- During power failure will automatically run the sump pump station
- Able to sit in standby mode
- Free standing and can be installed in any dry ventilated area
- Fitted in the power line meaning no additional electrical spurs are required
- Can operate as a standby unit or can be used in conjunction with the AlertMaxx2



---

## 110 OUTLET

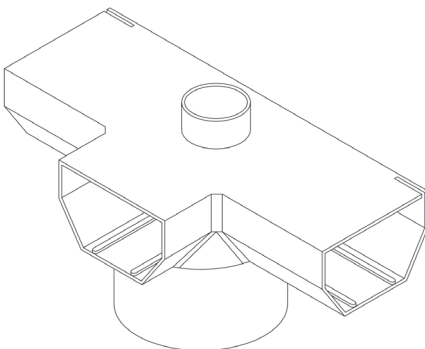

As an alternative to the Delta Channel, a Modular Drainage System may be considered using a 110mm standard underground drainage pipe. As with all drainage systems it must be maintainable. We recommend contacting a member of Delta's Technical Team when utilising this method.

# DELTA PRODUCTS FOR FLOOD RESILIENCE AND RECOVERABILITY



## KOSTER NB1

### Koster NB1 Grey Waterproofing Slurry

Koster NB1 is a mineral coated waterproofing slurry containing crystallising and capillary-plugging agents. It can be used for waterproofing against ground moisture and for non-pressurized and pressurized water.

- Positive and negative side waterproofing against pressurized water
- Resistant against chlorides, sulphates and phosphates
- Penetrates the surface where crystallization leads to inseparable waterproofing-substrate bond – does not contain corrosion promoting ingredients
- No VOC emissions
- Substrate does not have to be continually kept wet to cure
- Suitable for new construction and repair on existing structures

## KOSTER REPAIR MORTAR PLUS

Koster Repair Mortar Plus is a watertight, fast setting, slightly expanding repair mortar with excellent adhesion (even to old building material substrates). With the addition of Koster SB Bonding Emulsion, it can be used as a PCC (polymer-modified cement concrete) mortar.

- Watertight (Positive and negative side waterproofing)
- Fast Setting (Seamless, easy application)
- Slightly expanding
- Excellent adhesion
- Can be applied to all mineral substrates
- Suitable for watertight repairs and touch ups to substrates
- Can be used internally and externally on concrete, brickwork, blockwork or masonry



## KOSTER KD SYSTEM

### Koster KD System – Waterstop (including KD Base, KD Blitz and KD Sealer)

Koster KD System stops active water ingress and safely seals off pressurized water from the negative side within seconds!

- Waterproof sealing compound
- Fast Setting
- Can be applied to all mineral substrates
- Suitable for watertight repairs to substrates
- Watertight finish
- Can be used internally and externally on concrete, brickwork, blockwork or masonry





## DELTA EPOXY RESIN

Delta Water Based Epoxy Resin is suitable for all applications where concrete or masonry requires waterproofing and protection. It is applied in the same manner as ordinary emulsion paint with the added benefit of application in damp conditions.

- As a membrane to prevent raising damp in floors or anti-lime treatment of new concrete and act as an anti-lime pre-treatment to new concrete
- As a general waterproofing and decorative finish for all brick, concrete, cement and masonry surface
- For application to damp surfaces where other paints Cannot adhere
- As a sealing coat for asbestos containing materials
- All other applications where a waterproofing coating is required
- Can withstand chemical or spray cleaning

## KOSTER KB FLEX 200

Koster KB-Flex 200 is a permanent plastic sealing compound ideal for sealing pipe and cable penetrations, cavities and for custom detail waterproofing solutions against moisture and pressurized water.

- Waterproof sealing compound
- Watertight finish
- Ideal solution for sealing pipe and cable penetrations
- Does not dry out
- Can be applied to dry, moist or wet substrates
- Immediate functionality
- Can be used internally and externally on concrete, brickwork, blockwork or masonry



## KOSTER DEUXAN 2C

Koster Deuxan 2C is a robust crack-bridging (2 component polymer) modified bitumen thick film sealant for waterproofing construction. Deuxan 2C is designed for the secure and permanent exterior waterproofing and is suited for the intermediate waterproofing underneath screeds and for bonding insulation and drainage boards.

- BBA Approved
- Koster Deuxan 2C is satisfactory for use as a fully bonded, Type A Barrier protection waterproofing as defined in BS 8102:2009
- Positive and negative side waterproofing against pressurized water
- Can be used internally and externally on concrete, brickwork, blockwork or masonry, or as a dampproof and waterproof membrane for solid floors and tanking to provide an effective barrier to the transmission of liquid water

# DELTA PRODUCTS FOR FLOOD RESILIENCE AND RECOVERABILITY



## KOSTER PU 907

### Koster PU 907 Polyurethane Sealant

Koster PU 907 is a highly elastic, low modulus polyurethane sealant, with good UV resistance and excellent adhesion to typical construction materials.

Koster PU 907 is designed for civil and industrial movement, expansion, control and dilatation joints in architectural and heavy construction. An ideal sealant for use between concrete, mortar, brickwork, natural and synthetic stone, metal, steel, aluminium, wood, ceramic tiles and rigid plastics.

Koster PU 907 is a one component sealant that cures with moisture to form a flexible finish which can be overpainted after curing is finished. The sealant is non-sagging, highly thixotropic, offers easy smoothing and has good workability.

## PUDDLE FLANGE

A puddle flange offers an effective solution against water penetration around service pipes. Incorporating a puddle flange into designs ensures a watertight seal is offered where pipes pass through concrete structures (i.e. the walls of any structure below groundwater level and in flood resilience designs). Pipes passing through concrete will not bond to the concrete and water can pass along the external surface of the pipe, a puddle flange will act as a barrier to this flow. The seal body within the puddle flange is compressed during the concrete pouring process, should the concrete shrink during curing the rubber relaxes and maintains a seal against any flow path. A puddle flange is recommended for use around any pipe penetration in a below ground structure. Puddle flanges are available in various sizes from 32mm up to 160mm.



Image supplied courtesy of Aquobex



## NON-RETURN VALVES

Property flooding can also occur from the back-filling of sewerage pipes, causing flood water to enter via downstairs toilets and showers, plug holes, dishwashers, washing machines etc.

A non-return valve automatically closes when water or sewage flows back through the drain system during flood conditions. The stop valve allows normal sewage flow from the inlet to the outlet side of the valve with absolutely no flow restriction.

Image supplied courtesy of Aquobex



## FLOOD BARRIERS

There are a number of routes in which floodwater can enter a property. Potential routes for entry of flood water is via doors and sealants around doors.

A flood barrier is a specific type of floodgate. A flood barrier can be installed on a single door or joined together to create a flood wall or used to create a bund/compound around a key asset.

Simple but effective – flood barriers are a proven way to protect your business and home from flood risks.

## SELF-CLOSING AIR BRICKS

Airbricks are potentially vulnerable for flood water entry into a property during a flooding event. Self-Sealing/Closing Airbricks close as flood water rises, stopping water entry into a structure.

Air bricks provide underfloor ventilation and blocking them up to prevent water ingress isn't an option because condensation will form on the walls and floor timbers causing rising damp issues.

If your property has air bricks it's essential to include them in your flood protection plan.



Image supplied courtesy of Aquobex



## FLOOD DAMS

Flood Dams provide a demountable flood defence barrier for residential and commercial properties. Flood Dams offer little change to the immediate landscape it surrounds in normal circumstances. Flood Dams are used in many applications including community flood protection, road and railway closures, industrial and commercial premises and also coastal flood protection schemes.

Inflatable dams are a type of inflatable flood barrier for properties and are a perfect example of what homeowners can do to protect their homes and property from the ruin caused by floods. Flood Dams or water inflated flood barriers are designed so that they are reusable.

Registered Offices:

Delta House, Merlin Way, North Weald, Epping, Essex, CM16 6HR  
01992 523 523 | [info@deltamembranes.com](mailto:info@deltamembranes.com) | [www.deltamembranes.com](http://www.deltamembranes.com)