

5	6	7	8
REV.	ECN NO.	DATE	SIGN
			DESCRIPTION

ALTW
CONFIDENTIAL
2011.06.13
R&D DEPT.

- ① F Housing
- ② O-Ring*2
- ③ O-Ring
- ④ Nut
- ⑤ Ins_Housing

- ⑥ Pin Ass'y
- ⑦ PE Bag (HPE00910085)

- ⑧ Body

- ⑨ Seal(16MM)

- ⑩ Clamp Ring (16MM)

- ⑪ Clamp Nut (16MM)

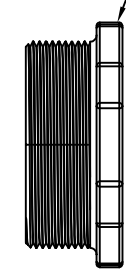
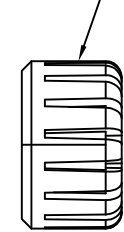
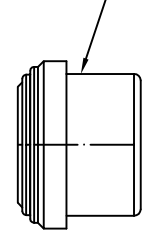
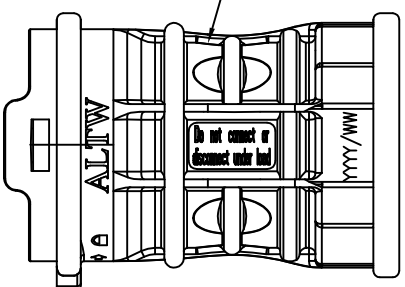
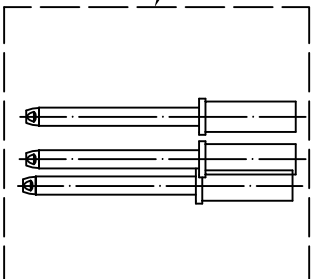
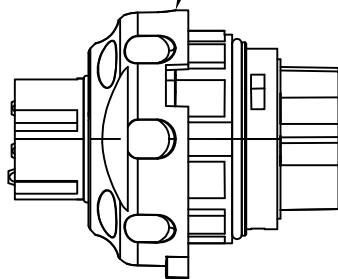

ALTW
DCC. DEPT.
CONFIDENTIAL
2011.07.04
ISSUED

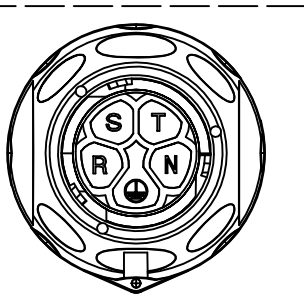

Pin Assignments
Front View

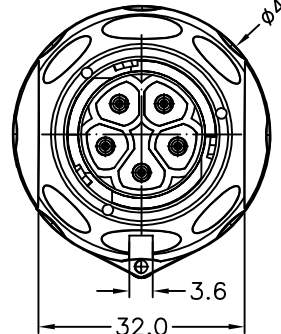

Conn.

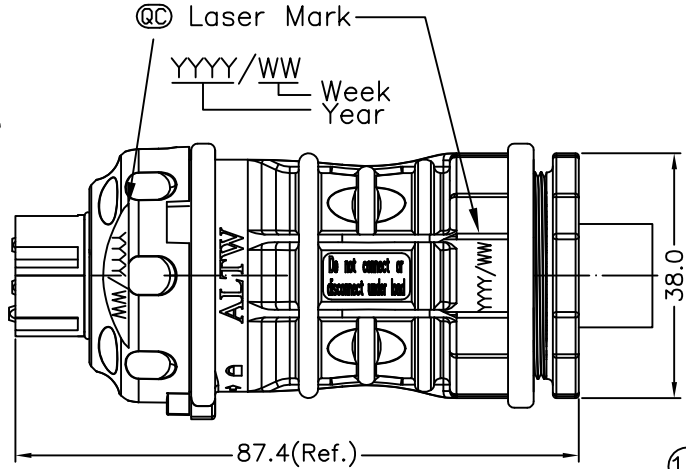

Note:

- * @C Important Dimensions To Check. (重點檢查尺寸)
- * Voltage (電壓) : AC 660V ; DC 1000V
- * Current (電流) : 25A
- * Please refer to manual for Ass'y instruction (使用方式請參閱組裝說明書)
- * Standard (認證) : ULXXXXX ; CSAXXXX ; TUVXXXXX
- * Waterproof Rate (防水等級) : IP68_3M6H (Mating 對接)
- * Female Housing (母膠芯) : m-PPE(F1), Black (黑)
- * Male Pin (母端子) : Copper (銅), Tin Plated (鍍錫)
- * O-ring (O型環) : Silicone (矽樹脂), Gray (灰)
- * Cable OD range (線材範圍) : 16mm~13mm
- * Wire Size (導體尺寸) : 12AWG
- * Flame Class (防火等級) : UL94V-0
- * ⑭ One Set Unassembled in one PE Bag.
- * ⑫⑬ One Set Ass'y Instructions & Tool in one PE Bag. (每包袋子中含有未組裝零件, 組裝說明書及工具)

UNIT:mm	
TOLERANCE	
.X	±0.25
.XX	±0.1
.XXX	±0.05
ANGLES	±1°

TITLE PV Power Conn 5Pin Cable(16MM) Female Conn Male Pin	
SCALE Free	SHEET 1 OF 1
REV. A	SIZE A4
@C : Inspection Item	

Amphenol LTW
安費諾亮泰企業股份有限公司

ITEM NO PWH-05BFMC-LL8001
DWG NO PWH-05BFMC-LL8001
CUSTOMER ALTW

DRAWN BY Micky	DATE 2011/06/13
CHECKED BY Kevin	DATE 2011/06/13
APPROVED BY Victor	DATE 2011/06/13

THIS DOCUMENT IS SUBJECT TO CHANGE WITHOUT NOTICE. IT IS CONFIDENTIAL AND A PROPERTY OF Amphenol LTW. DISCLOSED TO THIRD PARTY HAS TO BE AUTHORIZED BY Amphenol LTW.

F
E
D
C
B
A

1 2 3 4 5 6 7 8