



SAFETY AT THE HIGHEST LEVEL

The Safety Solution for Horizontal Life Lines



- CONFORMS TO EN 795 CLASS C AND PATENT PROTECTED BY GB 2389386
- FOR ROOF INSTALLATION OR HORIZONTAL / OVERHEAD APPLICATIONS ON STRUCTURES
- ALLOWS SPANS OF UP TO 15M AND 3 USERS
- COST EFFECTIVE ENGINEERED HORIZONTAL LIFE LINE



FM36179

Working at Height

Legislation states that any person working at height needs to be protected to prevent them from falling.

While working at height should be avoided altogether, often it is unavoidable. Where this is the case collective protection such as Guardrail systems should be considered first. There are occasions, for example when the building layout is inappropriate, aesthetics

may be compromised or cost makes collective protection unsuitable and so personal fall protection is the preferred option.

Used typically to protect workers involved in irregular maintenance tasks, a wire based horizontal life line system provides the most flexible, cost - effective option.

KeeLine® for Fall Protection

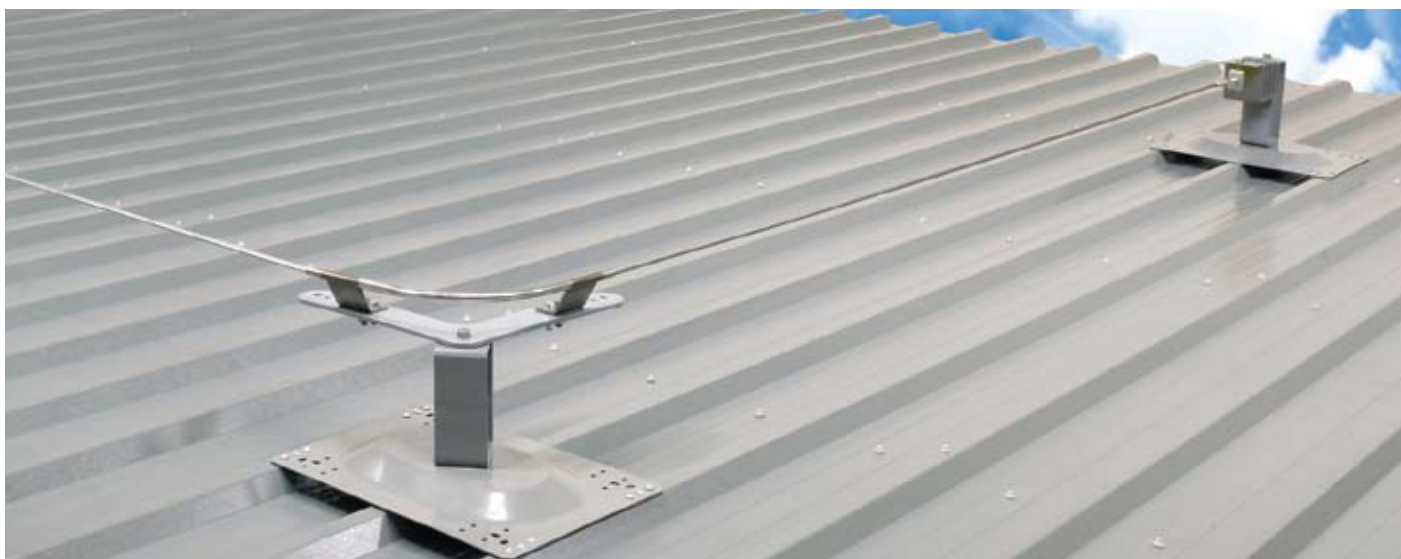

KEE LINE is a 8mm Gr.316 stainless steel wire system with electro-polished brackets, detachable travellers and powder coated anchors that provides flexible, continuous protection for multiple users working at height.

The system incorporates an Inline Shock Absorber that minimises the loads to an acceptable level for both the user and structure in the event of a fall.

The Inline Shock Absorber also allows the system to be installed to lightweight modern roof constructions. Unlike other systems, there is no need for expensive 'fall-over' posts at every support, but instead **KEE LINE** features unique 'see through' top fix posts with minimal roof penetration required.

KEE LINE is a development of Kee Safety's **LINEANKA** wire system and **TOPANKA** top fix roof anchors which have been successfully sold and installed in Europe since 2003 for a wide range of applications.

KEE LINE for Roofs comprises the wire system and brackets, top fix roof anchors for modern roof types and **POSTANKA** anchors where through fixing to the main building structure is preferred.

KEE LINE for Structures is available for mounting directly to concrete, steel, brick or stonework either in the horizontal or overhead application.

To ensure simple specification **KEE LINE** installations can be designed using the bespoke calculation software.

KEE LINE is also available for use with the **WIREANKA** range of deadweight anchors where it is preferred not to penetrate the roof at all, for permanent or temporary applications.

KEE LINE conforms to EN795 Class C, OSHA 1915.159, 1926.502M, ANSI Z359.1 2007 and AS/NZS 1891.2 and is CE Marked.

As Kee Safety offers one of the widest ranges of both collective and personal height safety products and systems; our approved partners are able to offer you the most suitable solution for your application.

KeeLine® for Roofs

Wire



8mm dia 7x7 IWRC Gr.
316 Stainless Steel.
Available cut to length or
1000m reels.



Swage Assembly



Used to terminate system.
Available Swaged or
Swageless.

Upright Post



Extremity upright post:
200mm x 100mm x 85mm

Intermediate/Corner
Upright Post:
150mm x 100mm x 85mm

Intermediate Bracket



One piece bracket for
intermediate supports.

Absorber

Used at both ends
of the system,
minimises loads
on structure to
below 10 kN.



Corner Bracket



Available in 90° or 135°
Accommodates internal
or external bends.

Extended Intermediate Bracket



One piece bracket. Each
extended arm adjustable
up to 15° to accommodate
site variations such as
ridges and gutters.

Tension Indicator



Used at start of system
(or both ends for systems
over 150m).

Indicates when system is
correctly tensioned.

Available Swaged or
Swageless.

KeeLine® Traveller



Allows user to attach at any
point on system.

No moving parts.

Passes corners and
intermediates without
needing to detach from the
system

KeeLine® for Roofs

Outline Roof Plan

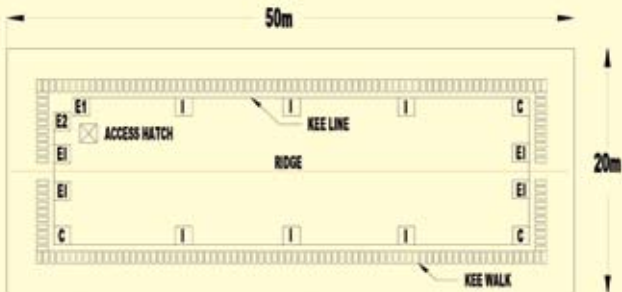

E1 Extremity Assembly (start of system)

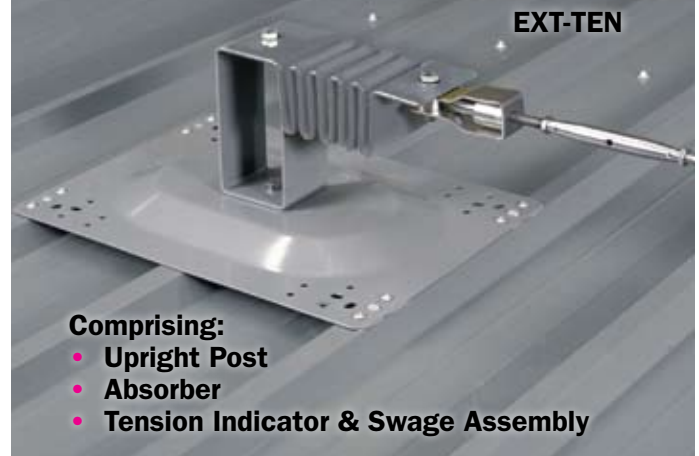

E2 Extremity Assembly (end of system)

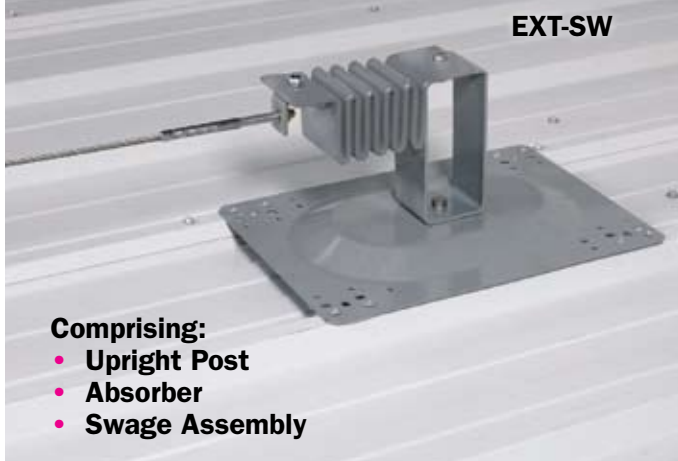

I Intermediate

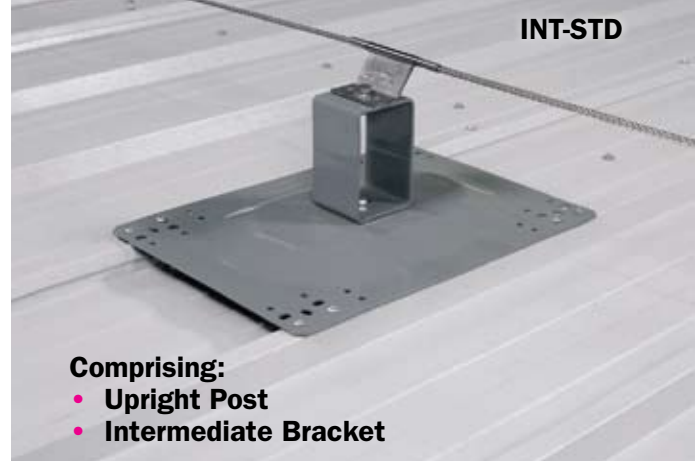

C Corner Assembly (90° or 135° options)

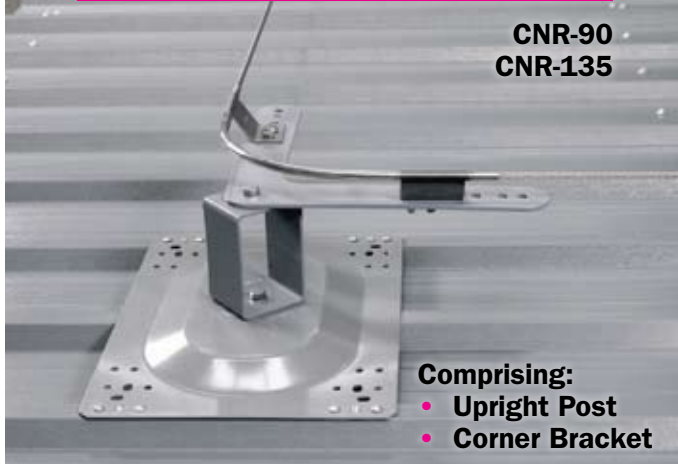

EI Extended Intermediate

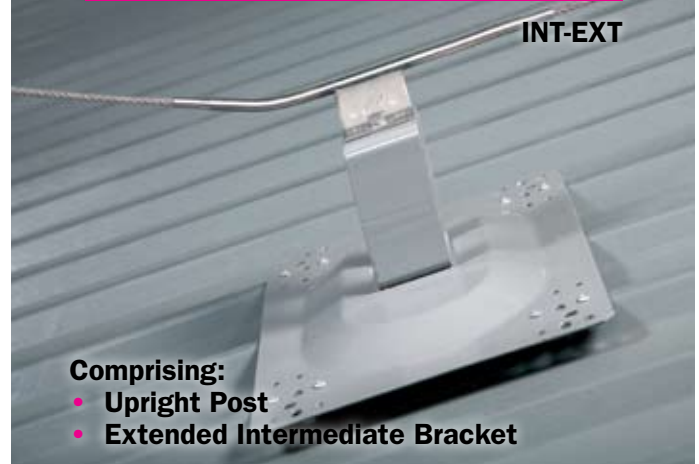

KeeLine® for Roofs

Base Plate Options

To enable easier specification and minimise stock holding the **KEE LINE** for Roofs range of base plates have been designed to suit end, corner and intermediate brackets.

MR Base plates for Metal profiled and Standing Seam roofs.

FR Base plates for Membrane roofs incorporate recessed holes for fixings to allow waterproofing membrane to sit flat on top of the baseplate.



SPS10



MR Base plates for profile metal roof panels

- Fixed with rivets - minimal penetration required
- Includes butyl sealing strip to maintain roofs integrity
- Fixing centres: 400, 500, 333, 310 to suit wide range of roof profiles.



SPS10



MR Base plates for standing seam roofs

- Fixed with non penetrative S5 clamps
- Fixing centres: 305, 400, 500.



SFL10



FR Base plates for membrane roofs with metal deck

- Top fixed with 4 toggle bolt assemblies
- Fixing centres: 400, 333, 470 to suit wide range of standard deck profiles.



SFL10



FR Base plates for membrane roofs with concrete deck

- Top fixed with resin fix anchors centres: 400, 333, 470.

KeeLine® for Roofs using Postanka®

The Kee Safety **POSTANKA** range offers an alternative fixing method when the roof structure is unsuitable for **KEE LINE** Top Fix anchors.

POSTANKA'S are designed to be installed directly to the building supporting structure for example on traditional tiled sloping roofs, historical buildings or directly to concrete roof decks for **KEE LINE** systems on green roofs or for abseil anchor points. Conforms to EN 795 Class A2.

Type 6 Standard

A standard version of the type 6 welded pedestal anchor has a flat baseplate with slotted holes to enable it to be specified for a wide range of steelwork flange widths or alternatively for fixing directly to the top of concrete roof decks with suitable fasteners. The design does not require any strengthening gussets so it makes it easy to weatherproof by an approved roofing contractor.

Suits flange sizes 90 to 190mm wide.
Available 250, 350 or 450mm high.

Rated to 10kN.
Galvanised finish to BS ISO EN 1461.

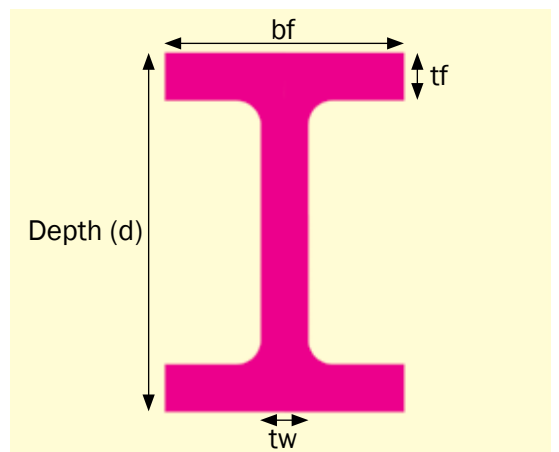

Postanka® Bespoke Options

Kee Safety provides a range of **POSTANKA** types quickly designed and manufactured to suit the clients specific application.

Galvanised finish to BS ISO EN 1461.

Site information required:

- Detail of support beam
- Height of **POSTANKA** above beam
- Fastener/fixing detail
- Loading

E.g. KEE LINE Extremity/Corner post:	10kN
Single point anchor/ KEE LINE intermediate post:	6kN
Abseil anchor:	15kN

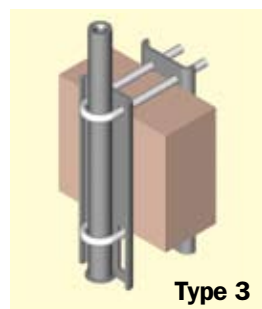

Type 3

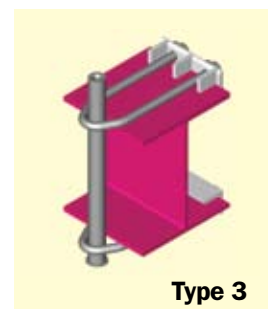

Type 3

Options

Type 3 for Steelwork

Type 3 for Timber

The **Type 3** post features an adjustable pedestal, ideal for irregular support structures or roof constructions.

Type 6

Welded pedestal anchor, multiple fixing options.

Suitable for Steelwork or concrete fixing



Type 6



Type 6

KeeLine® for Structures

Brackets for fixing directly to Steel, Concrete, Brick or Stone work, Suitable for horizontal or overhead applications.

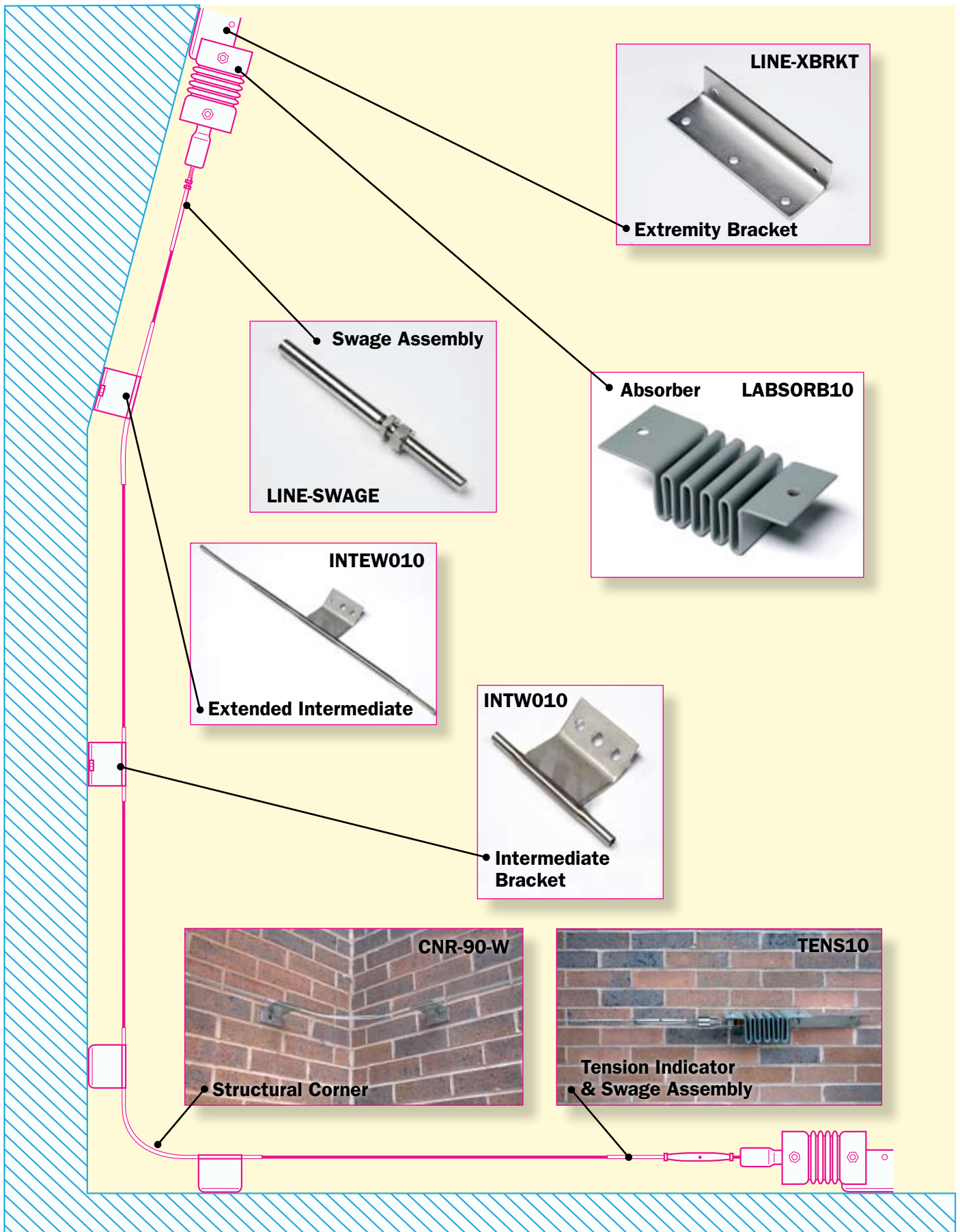

Why you should purchase KeeLine®



Features

- Conforms to EN795 Class C, ANSI Z359, CSA Z259, AS/NZS 1891
- CE Approved to the PPE Directive
- Development of existing LINEANKA & TOPANKA system's which have been successfully sold and installed in Europe for over 6 years
- Tested on 'as built' roofs in advance of EN795
- Efficient in-line absorber negates the need for expensive 'fall over' style posts at every bracket position
- Maximum span in between supports 15m
- Accommodates corners and varying building shapes
- Open style, low profile top fix posts to suit modern roof constructions including metal profile, standing seam and membrane roofs
- Comprehensive range of fixing options
- Horizontal or Overhead applications
- Traveller enables users to detach or re-attach at any point of the system
- Multiple users
- Modular design for easier specification
- Gr.316 Stainless Steel 8mm dia wire and bracket
- Available with non-penetrative WIREANKA option.



Benefits

- Provides users with total fall protection through continuous attachment whilst travelling the system
- Adaptable to different usage situations
- Durable and weather resistant
- Easy to design and install
- The design and specification process is simplified by the bespoke calculation software.



Kee Safety Ltd.
1 Boulton Road
Reading
RG2 0NH
United Kingdom

Tel: +44 (0) 118 931 1022
Fax: +44 (0) 118 931 1146

Email: sales@keesafety.com
www.keesafety.com/uk