



The Vital Parts Product Brochure



At Vital Parts Ltd we aim to provide a professional, stress free experience through a selection of top quality industrial products and an easy to use website.

It is our attention to detail and exemplary customer service that has proven to be the defining characteristic for our operations, and is why we have adopted the slogan, **we mould around you.**

“I was impressed by the massive range of products available on the easy to follow website, delivery was prompt the day after dispatch, and all the parts ordered arrived in good condition, well labelled and of high quality. I will definitely use this company again.” ~ **G. Alker**

- ✓ **Over 1,000,000 Parts In Stock**
- ✓ **Fast, Friendly, Efficient Service**
- ✓ **Next Day Delivery Available**
- ✓ **Trusted By FTSE 100 Companies**
- ✓ **24 Hour Operation**





End Caps



Plugs & Stoppers



Furniture & Chair Feet



Tube Inserts



High Temp Masking



Adjustable Feet



Cable Management



Fixings & Fasteners



Edging Strips



Bushes, Spacers & Washers



Gaskets & Rubber Seals



Industrial Hardware



Knobs, Grips & Handwheels



Pipe & Flange Protection



Scaffold Protection



Anti Vibration

End Caps or ‘covers’ are versatile products coming mainly in **Plastic & Rubber** styles, designed for **Finishing, Masking, Protection, and Sealing**.

Manufactured with both industrial and household uses in mind, you can rest assured **we have a cap that meets your needs.**



Size	mm	cm	Inches
M5	5	0.5	0.19
M6	6	0.6	0.23
M8	8	0.8	0.31
M10	10	1.0	0.39
M12	12	1.2	0.47
M14	14	1.4	0.55
M16	16	1.6	0.62
M18	18	1.8	0.70
M20	20	2.0	0.78

End Caps



Silicone Caps



PVC Caps



EPDM Caps



Nut Caps



Secure Nut Caps



Screw Caps



Tapered Caps



Threaded Caps



Threaded Sealing Caps



Rebar Safety Caps



Pull Tab Caps



Grease Nipple Caps



Heatshrink Caps



Post Caps



Pipe Caps

Silicone Caps

Round Silicone Caps

Product Code: **SIC**

0.89mm - 53.47mm

- ✓ High temperature resistant up to 315°C
- ✓ Flexible silicone for easy installation
- ✓ Perfect for all masking purposes
- ✓ Resistant silicone rubber



Silicone Cone Caps

Product Code: **SCC**

3.3mm - 16mm

- ✓ High temperature resistant up to 315°C
- ✓ Perfect for high temperature masking
- ✓ Covering caps to protect a thread
- ✓ Durable, can use multiple times



Silicone Eze Caps

Product Code: **EZE**

6mm - 21mm

- ✓ Made from a premium grade Silicone Rubber
- ✓ Cost effective covering solution
- ✓ High temperature resistance
- ✓ Flange for easy removal



PVC Caps

Round PVC Caps

Product Code: **CAP**

2.8mm - 200mm

- ✓ Manufactured from premium PVC
- ✓ Glossy black finish as standard
- ✓ Shock absorbing material
- ✓ Ideal for protection during transport



Square PVC Caps

Product Code: **SCAP**

10.7mm - 60mm

- ✓ Manufactured from a high end PVC
- ✓ Shock absorption properties
- ✓ Provides a clean, glossy black finish
- ✓ End caps for general protection uses



Rectangular PVC Caps

Product Code: **RCAP**

3mm - 40mm

- ✓ Manufactured using a premium form of PVC
- ✓ Comes with a glossy finish as standard
- ✓ Perfect grip for rectangular bars
- ✓ Pad printing compatible



Pull Tab PVC Caps

Product Code: **PTC**

3.6mm - 41.3mm

- ✓ Manufactured from a strong PVC
- ✓ Multiple resistive properties
- ✓ Ideal for thread protection
- ✓ 'Pull' tab for easy removal



High Temp PVC Caps

Product Code: **HCAP**

2mm - 50.8mm

- ✓ Manufactured from a high temp PVC
- ✓ For use in high temp environments
- ✓ Temperature resistant up to 210°C
- ✓ Bright yellow finish



Stud PVC Caps

Product Code: **CAP**

3.8mm - 11.9mm

- ✓ Manufactured from a high quality PVC
- ✓ Covers for exposed threads/studs
- ✓ Metric/imperial standard sizing
- ✓ Glossy black finish



EPDM Caps

Product Code: **EPC**

0.89mm - 53.47mm

- ✓ High temperature resistant up to 230°C
- ✓ Manufactured from a premium EPDM
- ✓ Great resistance to Acids and Alkali's
- ✓ Versatile, can be stretched



EPDM Eze Caps

Product Code: **EZE**

7.2mm - 36mm

- ✓ High Temperature resistance up to 230°C
- ✓ Manufactured from a high grade EPDM
- ✓ Resistant to Acids & Alkali's
- ✓ Ribbed for tight fitting



Nut Caps

Product Code: **NC**

M4 - M24

- ✓ Strong resistive properties, UV resistant
- ✓ Manufactured from a strong LDPE
- ✓ Made to fit industry sized nuts
- ✓ Covers for nut and bolt heads



M6 - M12

- ✓ Manufactured from a strong Polypropylene
- ✓ Ideal for use with inside playgrounds
- ✓ Locking covering cap included
- ✓ Available in 5 different colours



Screw Caps

Product Code: **CAP**

6 to 8 - 10 to 12

- ✓ Manufactured from reliable Polypropylene
- ✓ Available in 10 different colours
- ✓ Comes with matching washers
- ✓ Easily cover screw heads



Tapered Caps

Product Code: **TAC**

3mm - 52.5mm

- ✓ Reversible cap/plug for protecting or covering
- ✓ Manufactured from an LDPE Plastic
- ✓ Huge selection of sizes available
- ✓ Built in flange around its head



Threaded Caps

Product Code: **THC**

M8 - M52

- ✓ Manufactured from a LDPE Plastic
- ✓ Ergonomic head for easy removal
- ✓ Easily protects exposed threads
- ✓ Screw on installation



Threaded Sealing Caps

Product Code: **THC**

1/8" - 2 1/2"

- ✓ Manufactured using a strong HDPE
- ✓ Built in Neoprene disc for sealing
- ✓ Metric, BSP, and UNF threads
- ✓ Ideal for fluid / gas uses



Rebar Safety Caps

Product Code: **SAFE**

8mm - 50mm

- ✓ Manufactured from a premium LDPE
- ✓ Used to cover exposed poles/rebar
- ✓ Temperature & UV Resistant
- ✓ Industry standard sizes



Grease Nipple Caps

Product Code: **GNC**

6mm

- ✓ Manufactured from strong LDPE
- ✓ Easily fits over grease nipple
- ✓ Prevents build up of debris
- ✓ Industry standard design



Heat Shrink Caps

Product Code: **HSC**

12mm - 160mm

- ✓ Shrink to fit caps to cover an object
- ✓ Made from durable Polyolefin
- ✓ Good resistive properties
- ✓ Ideal for repairing cables



Post Caps

Product Code: **POST**

60mm - 273mm

- ✓ Caps to protect an internal section
- ✓ Great for finishing off post ends
- ✓ Available in LDPE or PVC styles
- ✓ Grey finish from standard



Pipe Caps

Product Code: **PIP**

37.7mm - 1642mm

- ✓ Manufactured from a resistant Polyethylene
- ✓ Easily fits over the face and lip of a pipe
- ✓ Ribbed for a tight and secure fitting
- ✓ Covers and protects against ingress



Plugs & Stoppers come in many shapes, types, and sizes, each designed for a selection of uses, including **masking, sealing, and protection**. Manufactured from **high strength, resilient materials**, we've carefully selected our range based on feedback from our customers.



Uses	Silicone	EPDM	PVC	Nylon	LDPE	HDPE
Masking	✓	✓	-	✗	✗	✗
Finishing	✗	✗	✓	✓	✓	✓
Protection	-	-	✓	✓	✓	✓
Sealing	✓	✓	✗	✗	✗	✗



Silicone Plugs



EPDM Tapered Plugs



Blanking Plugs



Door Stoppers



Tapered Plugs



Flanged Barrel Plugs



Threaded Plugs



Threaded Sealing
Plugs



Pipe End Plugs



Fir Tree Plugs



Finned Hole Plugs



Snap Fit Plugs



Ventilation Plugs



Snap Fit Bushes



Plastic End Plugs

Silicone Plugs (315°C)

Silicone Tapered Plugs

Product Code: **STP**

2.54mm - 127mm

- ✓ Made from premium high temp Silicone Rubber
- ✓ High temperature resistant up to 315°C
- ✓ Easily seals and protects excess holes
- ✓ Tapered to fit a range of widths



Silicone Ribbed Plugs

Product Code: **SRP**

3.99mm - 31.75mm

- ✓ High temperature resistant up to 315°C
- ✓ Made from premium Silicone Rubber
- ✓ Ideal for high temperature masking
- ✓ To mask off/protect threaded holes



Silicone Plugs with Handle

Product Code: **STPH**

4.8mm - 56mm

- ✓ Manufactured from heat resistant Silicone
- ✓ Handle for easy removal/installation
- ✓ Plugs to mask off and cover holes
- ✓ Alternative to standard plugs



Silicone Pull Plugs

Product Code: **SPP**

1.6mm - 25.9mm

- ✓ Manufactured from a high grade of Silicone
- ✓ Large selection of colours available
- ✓ Ideal for Powder Coating Masking
- ✓ Pull tab for efficient removal



Silicone Washer Plugs

Product Code: **SWP**

6.4mm - 24mm

- ✓ Manufactured from a high grade of Silicone
- ✓ For high temperature masking uses
- ✓ All in one plug and washer
- ✓ Comes in a natural finish



EPDM Tapered Plugs

Product Code: **ETP**

1.6mm - 127mm

- ✓ High Temperature resistant up to 215°C
- ✓ Manufactured from resilient EPDM
- ✓ Able to provide an air tight seal
- ✓ Tapered to fit range of sizes



Door Stoppers

Product Code: **SCOF**

15.9mm - 35mm

- ✓ Manufactured from strong resistant Rubber or TPR
- ✓ Counter sunk 'hidden' screw head design
- ✓ Prevents damage to walls / doors
- ✓ Perfect for absorbing shock



Tapered Plugs

Product Code: **TAP**

2.9mm - 298mm

- ✓ Manufactured from a durable LDPE
- ✓ Reversible plug or cap solution
- ✓ Resistant against acids/alkalis
- ✓ Useful for filling & protecting



Flanged Barrel Plugs

Product Code: **BAP**

2.1mm - 85mm

- ✓ Flanged for easy installation/removal
- ✓ Manufactured from a strong LDPE
- ✓ Acid and alkali resistant
- ✓ Great for sealing



Flexible Blanking Plugs

Product Code: **BLA**

4.7mm - 51.5mm

- ✓ Manufactured from PVC or TPE
- ✓ Acid & temperature resistant
- ✓ Flexible for ease of fitting
- ✓ Versatile component



Body Plugs

Product Code: **BLA**

10mm - 45mm

- ✓ Manufactured from a premium TPR
- ✓ Tapered shank for easy fitting
- ✓ Heat resistant up to 135°C
- ✓ Provides a clean finish



Domed Blanking Plugs

Product Code: **BLA**

4.8mm - 51mm

- ✓ Manufactured using a heat stabilized Nylon
- ✓ Available in a Black or White finish
- ✓ Built in fixing clips, locks in place
- ✓ Thin domed head



Double D Blanking Plugs

Product Code: **BLA**

11.9mm - 55.1mm

- ✓ Locking fingers fit multiple panel thicknesses
- ✓ For 'Double D' or flat sided mounting holes
- ✓ Manufactured from a UL94V-2 rated Nylon
- ✓ Approximate head thickness of 1.6mm



Insulation Plugs

Product Code: **BLA**

31.3mm x 17.5mm

- ✓ Manufactured from a UL94V-2 rated Nylon 6/6
- ✓ Temperature resistant -40°C to 105°C
- ✓ Convex matte finish style head
- ✓ No maximum panel thickness



Knock Out Seals

Product Code: **BLA**

22.2mm - 63.5mm

- ✓ Manufactured from a high quality Nylon 6/6
- ✓ UL94V-2 or UL94V-0 flammability
- ✓ Industry standardised sizings
- ✓ Designed to be knocked out



Pry Out Blanking Plugs

Product Code: **BLA**

6.4mm - 63.5mm

- ✓ Manufactured from a UL94V-2 rated Nylon
- ✓ Designed to retain but not lock in place
- ✓ Finished with a flat matte head
- ✓ Head thickness ~1.6mm



Pronged Pry Out Plugs

Product Code: **BLA**

.9mm - 12.4mm

- ✓ Manufactured from a UL94V-2 rated Nylon
- ✓ Black or Natural finishes available
- ✓ Pronged locking finger design
- ✓ Great for smaller holes



Rectangular Blanking Plugs

Product Code: **BLA**

24.5mm - 26mm

- ✓ Manufactured from a UL94V-2 rated Nylon
- ✓ Range of standard fitment options
- ✓ Rectangular style head
- ✓ Finished in Black



Viewport Window Plugs

Product Code: **BLA**

4.7mm - 50.8mm

- ✓ Manufactured from a UL94V-2 rated Polycarbonate
- ✓ Clear finish for easy internal viewing
- ✓ Round and oval styles available
- ✓ Locking fingers for easy fitment



Shorty Viewport Window Plugs

Product Code: **BLA**

13mm - 25.7mm

- ✓ Manufactured from a UL94V-2 rated Polycarbonate
- ✓ Single locking position for thinner panels
- ✓ For adding an internal viewing port
- ✓ For panels up to 1.6mm



Liquid Tight Break Through Plugs

Product Code: **BLA**

12.7mm - 38.1mm

- ✓ Can be broken through or used as a liquid tight plug
- ✓ Manufactured from Nylon 6/6 and TPE Rubber
- ✓ Liquid tight rated to IP67/68 standards
- ✓ HB flammability rated



Liquid Tight Blanking Plugs

Product Code: **BLA**

12.7mm - 34.9mm

- ✓ Liquid tight, Oil tight and submersible product
- ✓ Manufactured from a resistant TPE Rubber
- ✓ UL certified for outdoor applications
- ✓ UL94V-0 flammability rating



Threaded Plugs

Product Code: **THP**

M10 - M42

- ✓ Manufactured from a durable Polyethylene
- ✓ Screw in thread protection solution
- ✓ Ergonomic gripping head
- ✓ Protects internal thread



Threaded Sealing Plugs

Product Code: **THP**

M10 - M52

- ✓ Manufactured from a strong HDPE Plastic
- ✓ Useful with oils, liquids and gases
- ✓ Built in Nitrile O-Ring for sealing
- ✓ Provides a high quality seal



Fir Tree Plugs

Product Code: **FTP**

3mm - 10mm

- ✓ Manufactured from a strong Nylon 6/6
- ✓ Durable and long lasting solution
- ✓ Locks panels into place
- ✓ Barbed for security



Washer Masking Plugs

Product Code: **WMP**

3.2mm - 47mm

- ✓ Manufactured from quality TPR
- ✓ High temp resistant to 125°C
- ✓ Masks off hole/washer area
- ✓ Acid and alkali resistant



Pipe End Plugs

Product Code: **RPP**

10mm - 114.3mm

- ✓ Manufactured using a strong LDPE plastic
- ✓ Multiple ribs to promote a secure fit
- ✓ Seals for the end of a tube or pipe
- ✓ Prevents ingress and wear



Finned Hole Plugs

Product Code: **FIN**

9.5mm - 28.6mm

- ✓ Finned ribs for a tight and secure fitting
- ✓ Manufactured from a blue LDPE plastic
- ✓ Pull tab for easy installation & removal
- ✓ Seals off excess holes



Tube End Plugs

Product Code: **TUBE**

1" - 10"

- ✓ Industry standard packaging tube sizes
- ✓ Designed for use with packing tubes
- ✓ Manufactured from a durable LDPE
- ✓ Available in Black / White



Snap Fit Plugs

Product Code: **SFP**

M10 - M42

- ✓ Manufactured from a strong LDPE
- ✓ Easy to install and remove
- ✓ For filling in excess holes
- ✓ Ergonomic design



Vent Plugs

Product Code: **VENT**

12.7mm - 101.6mm

- ✓ Manufactured from high quality Nylon 6/6
- ✓ Comes with or without Polyurethane filter
- ✓ Thin head & fixing clips for flush fitment
- ✓ Heat resistant from -40°C to 105°C



Louvered Vent Plugs

Product Code: **VENT**

22.2mm - 76.2mm

- ✓ Manufactured from a UL94-V2 flammability
- ✓ Available with/without Polyurethane filter
- ✓ Temperature resistance -40°C to 105°C
- ✓ Used as a ventilation solution



Liquid Tight Snap In Vent Plugs

Product Code: **VENT**

12.7mm - 28.6mm

- ✓ Maximum airflow: ≥ 16.6 LPM/3.7cm² @ 13.5 psi
- ✓ Manufactured from a UL94V-2 Nylon 6/6 body
- ✓ Pressure compensating sealing washer
- ✓ IP 65 / 67 / 68



Threaded Vent Plugs

Product Code: **VENT**

M12 - M20

- ✓ Manufactured from high quality Nylon 6/6
- ✓ Hex shaped head for wrench installation
- ✓ NPT, PG and Metric thread types
- ✓ Multiple resistive properties



Liquid Tight Threaded Vent Plugs

Product Code: **VENT**

M12 - M20

- ✓ Manufactured from high quality Nylon 6/6
- ✓ Pressure compensating sealing washer
- ✓ Prevents contamination and ingress
- ✓ IP 65 / 67 / 68



Snap Fit Bushes

Product Code: **SFB**

4.7mm - 19.1mm

- ✓ Manufactured from a UL94V-2 rated Nylon 6/6
- ✓ For insulating and threading cables
- ✓ Single or multiple locking steps
- ✓ Available in White or Black



Open/Closed Bushes

Product Code: **SFB**

7mm - 63.5mm

- ✓ Made from a UL94V-2 rated Nylon 6/6
- ✓ Split design fits range of cable widths
- ✓ Insulates and protects exposed wires
- ✓ Multiple locking steps



Threaded Smooth Bore Bushings

Product Code: **SFB**

1/4" - 3/4"

- ✓ Manufactured from a UL94V-2 rated Nylon 6/6
- ✓ Mechanically protects and insulates cables
- ✓ NPT threaded from 1/4 to 3/4
- ✓ Smooth central bore



Armor Cable Bushings

Product Code: **SFB**

9.4mm - 18.5mm

- ✓ Manufactured from a High Dielectric Polyethylene
- ✓ Withstands temperatures as low as -40°C
- ✓ For use with BX or FMC type cables
- ✓ Chamfered edge for easy install



Plastic End Plugs

Product Code: **PIP**

21mm - 80mm

- ✓ Manufactured from a high quality LDPE Plastic
- ✓ Available for Square and Rectangular tubes
- ✓ Great for protection against ingress
- ✓ Cost effective product



Furniture & Chair Feet

Being one of the **UK's largest supplier of chair and furniture feet**, our selection is vast and includes products designed for all kinds of uses, from **school chairs to sofas**. Manufactured from carefully selected **anti marking materials**, we aim to provide **fantastic quality every time**.

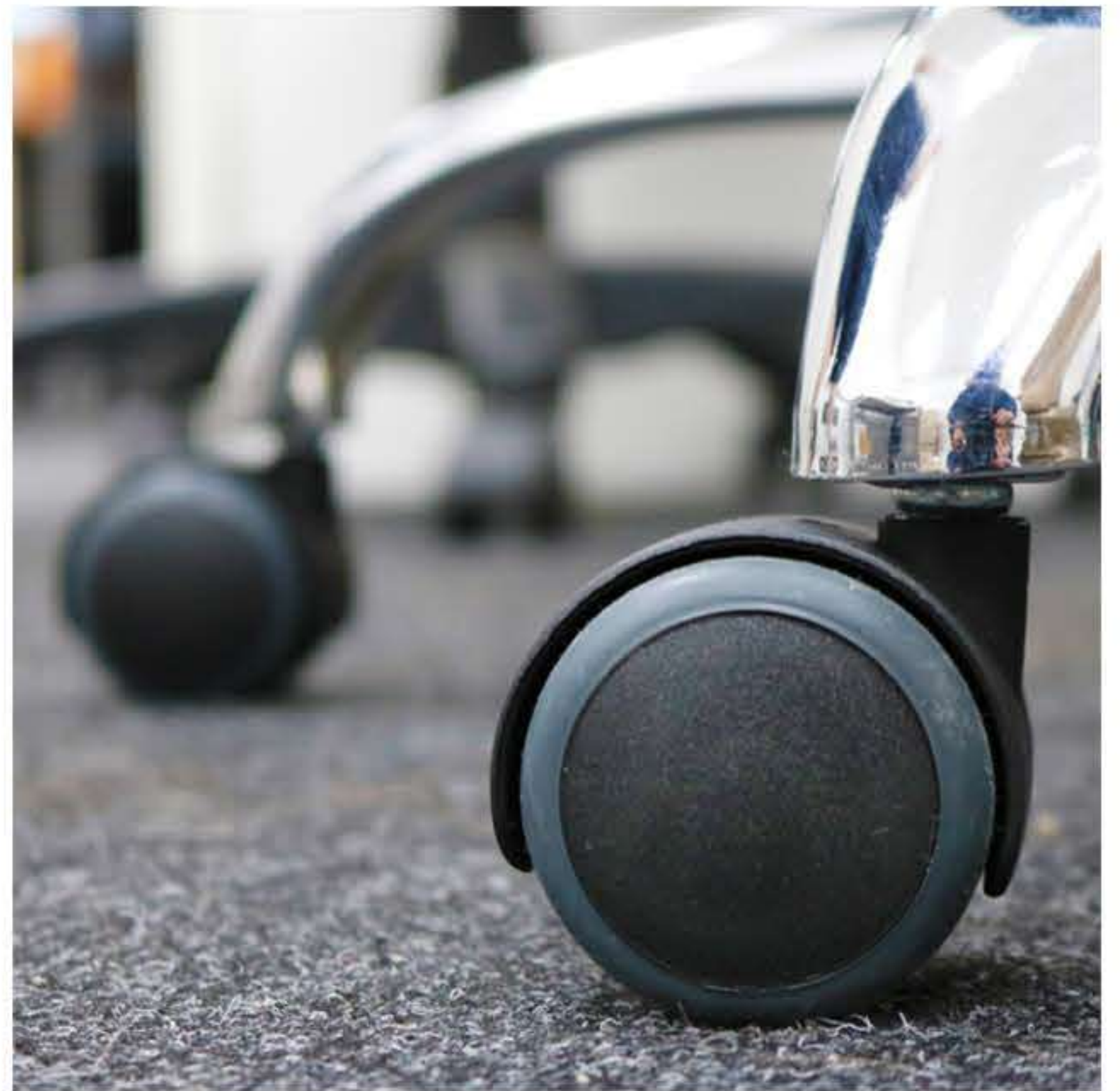

Surface	Glide Material	Feet Material
Carpet	PTFE / Metal	Plastic
Wood	Felt / PTFE	Rubber / Plastic
Vinyl	PTFE / Nylon	Plastic
Tile	Felt /PTFE	Rubber
Stone	PTFE / Nylon	Plastic
Concrete	Metal	Plastic
Rubber	Metal / Nylon	Plastic / Rubber



Plastic & Rubber
Ferrules



Chair & Furniture
Glides



Chair & Furniture
Castors



Screw On Feet



Saddle Feet



Push In Feet



Sofa Feet



Stick On Feet

Plastic and Rubber Ferrules

Round Tapered Ferrules

Product Code: **FERR**

9.5mm - 19mm

- ✓ Manufactured from anti-marking LDPE
- ✓ For angled / flat chair or furniture legs
- ✓ Black finish from standard
- ✓ Tapered base



Round Flat Ferrules

Product Code: **FERR**

19mm - 114.3mm

- ✓ Manufactured from anti-marking LDPE
- ✓ Ideal for large furniture / desks
- ✓ Highly durable option
- ✓ Replacement ferrules



Round Angled Ferrules

Product Code: **FERR**

16mm - 22mm

- ✓ Manufactured from anti-marking LDPE
- ✓ Designed for angled chairs/furniture
- ✓ Glossy Black finish
- ✓ Angled base



Square Plastic Ferrules

Product Code: **FERR**

19mm - 60mm

- ✓ Manufactured from anti-marking LDPE
- ✓ Suitable for hard or wooden flooring
- ✓ Black and White options stocked
- ✓ Fits a wide range of furniture



Styled Ferrules

Product Code: **FERR**

12mm - 32mm

- ✓ Compatible with walking sticks / crutches
- ✓ Manufactured from a durable Neoprene
- ✓ Great for chairs and furniture
- ✓ Comes in 3 different styles



Crutch Style Rubber Ferrules

Product Code: **FERR**

16mm - 25mm

- ✓ Manufactured from a heavy duty Rubber
- ✓ Ferrules for walking sticks or crutches
- ✓ Grey or black versions in stock
- ✓ Metal washer reinforced base



Furniture & Chair Feet

Screw On Glides

Product Code: **NAI**

19mm - 60mm

- ✓ Manufactured from a premium PTFE
- ✓ Screw in feet for chairs and furniture
- ✓ Ideal for heavy / moderate uses
- ✓ Reinforced steel washer base



Adhesive Glides

Product Code: **PAD**

10mm - 65mm

- ✓ Strong and reliable adhesive backing
- ✓ Helps furniture glide across a surface
- ✓ Available in a variety of shapes
- ✓ Available in felt or PTFE



Insert Glides

Product Code: **RO**

16mm - 32mm

- ✓ Ribbed for a tight and secure fitting
- ✓ Perfect for gliding across a surface
- ✓ Available with a PTFE or Felt base
- ✓ Easily installed into tubes



Metal Spring Insert Glides

Product Code: **RO**

19mm - 38mm

- ✓ Glides for heavy furniture or appliances
- ✓ Manufactured from a premium Steel
- ✓ Ideal for metal tubing
- ✓ For hard/soft floors



Furniture & Chair Feet

Tilting Felt Glides

Product Code: **RO**

14mm - 22mm

- ✓ Manufactured from a premium Polyethylene & Felt
- ✓ Suitable for tubular Chairs/Appliances
- ✓ Comes with a ball joint tilting base
- ✓ Felt base to reduce friction



Metal Nail-On Glides

Product Code: **NAI**

19mm - 30mm

- ✓ Manufactured from a high quality metal
- ✓ Ideal for both soft and hard surfaces
- ✓ Easy to fit nail insert
- ✓ Chrome finish



Teflon Nail-On Glides

Product Code: **NAI**

19mm - 30mm

- ✓ Manufactured from Teflon & Steel
- ✓ Easily glides furniture and chairs
- ✓ Nail insert glide solution
- ✓ Simple install



Nylon Nail-On Glides

Product Code: **NAI**

19mm - 27mm

- ✓ Manufactured from a high quality Nylon
- ✓ Available in brown and natural finishes
- ✓ Perfect for gliding or sliding
- ✓ Easy to fit product



Round Chair Feet

Product Code: **RO**

10mm - 47.5mm

- ✓ Manufactured from a premium LDPE
- ✓ Long lasting and durable
- ✓ Simple push fit design
- ✓ Ideal for tubular legs



Round Coloured Chair Feet

Product Code: **RO**

19mm

- ✓ Manufactured from a premium LDPE
- ✓ Available in 5 bright colours
- ✓ Easy to fit replacement feet
- ✓ Provides stability and grip



Round Angled Chair Feet

Product Code: **RO**

16mm - 25mm

- ✓ Manufactured from a premium LDPE
- ✓ Designed for angled tubular legs
- ✓ Strong external shank for fitting
- ✓ Available in 6 colours



Round Domed Chair Feet

Product Code: **RO**

16mm - 76.2mm

- ✓ Manufactured from a high quality LDPE
- ✓ For use with angled or uneven flooring
- ✓ Ribbed for ease of fitting
- ✓ Domed head



Wide Base Feet

Product Code: **RO**

26mm - 36mm

- ✓ Manufactured from a strong LDPE
- ✓ Perfect for heavy furniture/chairs
- ✓ Spreads weight across its base
- ✓ Ideal heavy duty upgrades



Thick Base Feet

Product Code: **RO**

15mm - 38mm

- ✓ Great for adding height to chairs / furniture
- ✓ Manufactured from a Black Polyethylene
- ✓ Ribbed for a secure installation
- ✓ Thick base for height



Square Chair Feet

Product Code: **SQ**

10mm - 90mm

- ✓ Manufactured from a strong LDPE
- ✓ Weight distribution properties
- ✓ Ribbed for tight fitting
- ✓ Fits box sections



Square Angled Chair Feet

Product Code: **SQ**

15mm - 25mm

- ✓ Manufactured using a high quality LDPE
- ✓ Good for weight distribution and grip
- ✓ Ideal for angled chair/desk legs
- ✓ Prevents scratching of floors



Square Domed Chair Feet

Product Code: **SQ**

20mm - 25.4mm

- ✓ Manufactured from a durable LDPE
- ✓ Ribbed for a tight secure fitting
- ✓ Multi-purpose domed head
- ✓ For use with angled legs



Square Coloured Chair Feet

Product Code: **SQ**

19mm

- ✓ Manufactured from quality LDPE
- ✓ Available in 5 bright colours
- ✓ Provides grip and stability
- ✓ Ribbed for secure fitting



Rectangular Chair Feet

Product Code: **REC**

10mm - 50.8mm

- ✓ Manufactured from a strong LDPE
- ✓ For use with a range of surfaces
- ✓ Weight resistant design
- ✓ Ribbed for tight fitting



Rectangular Angled Chair Feet

Product Code: **REC**

15mm - 50mm

- ✓ Manufactured from a strong LDPE
- ✓ Ribbed for a secure fitting
- ✓ For use with angled legs
- ✓ Angled base



Castor Cups

Product Code: **CST**

60mm

- ✓ Manufactured from a Black Polypropylene
- ✓ Prevents movement of a wheel
- ✓ Designed to fit common castor
- ✓ Perfect for Office Chairs



Tower Castor Glides

Product Code: **CST**

50mm

- ✓ Manufactured from Polyamide Plastic & Steel
- ✓ Aids movement of heavy applications
- ✓ Replacements for castor wheels
- ✓ Provides a sturdy base



Screw On Rubber Feet

Product Code: **SCOF**

15.9mm - 35mm

- ✓ Manufactured from strong resistant Rubber
- ✓ Counter sunk 'hidden' screw head area
- ✓ Ideal for use with wooden furniture
- ✓ Feet for heavy furniture



Screw On Plastic Feet

Product Code: **SCOF**

20mm - 40mm

- ✓ Manufactured from a strong Polypropylene
- ✓ Great for use with soft surfaces
- ✓ Prevents damage to surfaces
- ✓ Aids movement of furniture



Screw On TPVC Feet

Product Code: **SCOF**

16mm - 50mm

- ✓ Manufactured from an anti marking TPVC
- ✓ Supplied with matching screws
- ✓ Excellent grip properties
- ✓ Black or white finish



Tube Saddle Feet

Product Code: **SAD**

14mm - 30mm

- ✓ Manufactured from LDPE or Nylon 6/6
- ✓ Use with tubular Chairs & Furniture
- ✓ Available with/without fixing peg
- ✓ Runs parallel to floor



Furniture & Chair Feet

Tube Saddle Glides

Product Code: **SAD**

1mm - 53mm

- ✓ Specifically designed for tubular Furniture
- ✓ Reduces friction and prevents scratching
- ✓ Easily installed via screw/peg
- ✓ Available in 8 styles



Tube Saddle Bases

Product Code: **SAD**

22mm - 30mm

- ✓ Fixes into tubular chairs / furniture
- ✓ Manufactured from a strong LDPE
- ✓ Acts as feet for parallel tubes
- ✓ Fixing pegs as standard



Push In Feet

Product Code: **PIF**

7.9mm - 25.3mm

- ✓ Manufactured from a strong and durable PVC
- ✓ Prevents scratching of surfaces
- ✓ Available in eight styles
- ✓ Quick and easy to fit



Sofa Feet

Product Code: **SOFA**

35mm - 90mm

- ✓ Manufactured from high strength materials
- ✓ Upgrades or replacement Sofa Feet
- ✓ Tested across many surfaces
- ✓ Comes in 3 different styles



Furniture & Chair Feet

38mm Castors

Product Code: **CST**

10mm - 55mm

- ✓ Manufactured from high strength polyamide
- ✓ Available in both hard and soft wheel types
- ✓ Stemmed, Threaded, & Fixed Plate types
- ✓ Braked versions also available



50mm Castor Wheels

Product Code: **CST**

10mm - 11mm

- ✓ Fits the majority of office chairs and furniture
- ✓ Available in both hard and soft wheel types
- ✓ Manufactured from high quality materials
- ✓ Braked versions also available



75mm Castors

Product Code: **CST**

50mm - 125mm

- ✓ Large diameter made for an ease of movement
- ✓ Made from a polyamide and steel pairing
- ✓ Stemmed, Threaded, & Fixed Plate types
- ✓ We offer braked and unbraked versions



Conductive Castors

Product Code: **CST**

50mm - 125mm

- ✓ Designed to dispel the build up of static electricity
- ✓ Made from a polyamide and polyurethane
- ✓ Stemmed, Threaded, & Fixed Plate types
- ✓ We offer braked and unbraked versions



Antimicrobial Castors

Product Code: **CST**

50mm - 125mm

- ✓ Made from a polyamide and polyurethane
- ✓ Specialised anti-microbial coating
- ✓ Soft tyre for hard surfaces
- ✓ Comes in all fitments



Stick On Feet

Product Code: **SOF**

6.4mm - 45.7mm

- ✓ Manufactured from a high quality Rubber
- ✓ Recommended as appliance feet
- ✓ Strong self adhesive backing
- ✓ Installed in seconds



Tube Inserts or 'Tube End Caps' are popular for a variety of uses from Chair Feet, to End Caps for tubes. Stocked in almost every size and shape imaginable, you can guarantee that we have the **perfect option** for your desired application.



Are you unsure of what size insert you need?

16mm

19mm

22mm

25mm

30mm

Match the outside diameter of your tube to the outside diameter of our Tube Inserts.

Please note wall thicknesses may vary

For more information, visit our fitting guide here:

<https://www.vital-parts.co.uk/vital-guide-to-tube-inserts-26-w.asp>

Tube Inserts



Threaded Tube Inserts



Round Tube Inserts



Square Tube Inserts



Rectangular Tube Inserts



Oval Tube Inserts



Chromed Tube Inserts



Domed Tube Inserts



Thin Head Tube Inserts



Tube Connectors

Threaded Tube Inserts

Round Threaded Tube Inserts

Product Code: **ROT**

M6 - M12

- ✓ Manufactured using a strong LDPE
- ✓ Compatible with Machine feet
- ✓ Adds functionality to a tube
- ✓ Ribbed shank for fitting



Square Threaded Tube Inserts

Product Code: **SQT**

M6 - M12

- ✓ Manufactured from a strong LDPE
- ✓ Ribs for tight fitting and stability
- ✓ Compatible with male threads
- ✓ Fits into box sections



Rect. Threaded Tube Inserts

Product Code: **RECT**

M6 - M10

- ✓ Manufactured from a strong LDPE plastic
- ✓ Ribbed for tight fitting
- ✓ Multi-purpose design
- ✓ Variety of sizes



Heavy Duty Threaded Tube Inserts Product Code: **SQT/ROT**

M10 - M20

- ✓ Manufactured from a reinforced Nylon
- ✓ Nickel plated Brass or SS thread
- ✓ Ribbed for secure fit
- ✓ Heavy-duty solution



Metal Threaded Tube Inserts

Product Code: **MTI**

M10 - M12

- ✓ Manufactured from strong Aluminium
- ✓ Round, Square, or Rectangular sizes
- ✓ Ideal for use with threaded feet
- ✓ Excellent weight rating



Spring Threaded Tube Inserts

Product Code: **SPR**

M6 - M10

- ✓ Manufactured from a strong Spring Steel
- ✓ Simple to fit and install option
- ✓ Secure internal fitting
- ✓ Prevents flow-drilling



Tube Inserts

Round Tube Inserts

Product Code: **RO**

10mm - 195mm

- ✓ Manufactured from a strong LDPE
- ✓ Ribbed to promote tight fitting
- ✓ Ideal for finishing tubes
- ✓ Prevents ingress



Round Angled Tube Inserts

Product Code: **RO**

16mm - 25mm

- ✓ Angled base for use with angled tubular legs
- ✓ Manufactured from a strong LDPE
- ✓ Available in 6 different colours
- ✓ Strong external shank



Round Heavy Duty Tube Inserts

Product Code: **RO**

15mm - 38mm

- ✓ Manufactured from a Black Polyethylene
- ✓ Equipped with an extended base
- ✓ Supports heavy applications
- ✓ Easily installed



Square Tube Inserts

Product Code: **SQ**

10mm - 150mm

- ✓ Manufactured from a strong LDPE Plastic
- ✓ Designed for box sections
- ✓ Ribs for a stable fitting
- ✓ Flush fitting



Tube Inserts

Square Angled Tube Inserts

Product Code: **SQ**

15mm - 25mm

- ✓ Manufactured using a strong form of LDPE
- ✓ Ribbed for tight and secure fitting
- ✓ Prevents ingress into a tube
- ✓ Angled base from standard



Rectangular Tube Inserts

Product Code: **REC**

15mm - 76.2mm

- ✓ Manufactured using a hard wearing LDPE
- ✓ For use with Tubes, Pipes & Posts
- ✓ Ribbed for a tight secure fitting
- ✓ Great for blanking



Rectangular Angled Tube Inserts

Product Code: **REC**

15mm - 50mm

- ✓ Manufactured from a strong LDPE
- ✓ Ribbed for a tight secure fitting
- ✓ Multi purpose design
- ✓ Angled base



Oval Tube Inserts

Product Code: **OV**

10mm - 60mm

- ✓ Manufactured from a strong LDPE
- ✓ Great for finishing oval tubes
- ✓ Ribbed for a tight fitting
- ✓ Multi-purpose part



Tube Inserts

Oval Angled Tube Inserts

Product Code: **OV**

30mm x 15mm

- ✓ Manufactured from a strong LDPE
- ✓ Oval shaped with angled head
- ✓ For use with oval tubes
- ✓ Ribbed for a secure fit



Chromed Tube Inserts

Product Code: **RO/SQ/REC/OV**

13mm - 80mm

- ✓ Manufactured from a high quality LDPE
- ✓ Round, Square, or Oval sizes
- ✓ Ideal for finishing off holes
- ✓ Clean chromed finish



Domed Tube Inserts

Product Code: **RO/SQ**

16mm - 76.2mm

- ✓ Manufactured from a strong LDPE Plastic
- ✓ Fitted with ribs for tight fitting
- ✓ Provides an aesthetic finish
- ✓ Round and Square sizes



Thin Head Tube Inserts

Product Code: **RO/SQ/REC**

10mm - 88.9mm

- ✓ Manufactured from a strong LDPE
- ✓ Ribbed shank for security
- ✓ Round and Square sizes
- ✓ Discrete application



Tube Inserts

Tube Connectors

Product Code: **TC**

20mm - 30mm

- ✓ Manufactured from a high quality Nylon
- ✓ Perfect for all kinds of metal tubing
- ✓ Comes in 7 different styles
- ✓ For square box sections



Saddle Tube Connectors

Product Code: **TC**

15mm - 32mm

- ✓ Manufactured from Nylon 6/6 & Zinc Steel
- ✓ For use with round tubes or sections
- ✓ Threaded insert for fixing
- ✓ Expanding ribs



Round Straight Tube Connectors

Product Code: **TC**

15mm - 40mm

- ✓ Manufactured from a high quality Nylon & Zinc Steel
- ✓ Provides a straight or 180° connection
- ✓ Great for extending tubing
- ✓ Suitable for round tubes



Plastic Threaded Tube Inserts

Product Code:

M6 - M12

- ✓ Manufactured from high quality LDPE
- ✓ Round, Square, or Rectangular sizes
- ✓ Cheaper alternative to steel thread
- ✓ Easy to fit



As a **UK High Temperature Masking Supplier**, we have a variety of solutions carefully designed for **masking uses**, put through **rigorous tests to ensure high performance**. Offering many solutions from High Temp Tapes, to Pre-Cut Discs For Wheels, see why we're one of the **most trusted masking suppliers**.



Tape	Temp Resistance	Thickness	Adhesive	Property
Polyester	230°C	50 μ (micron)	Silicone	Flexible
25 micron Polyester	180°C	25 μ (micron)	Silicone	Precision
Polyimide	260°C	60 μ (micron)	Silicone	High Temp
Anti-static Polyimide	260°C	60 μ (micron)	Silicone	Anti-Static
Aluminium	120°C	110 μ (micron)	Acrylic	Conductive
Glass Cloth	180°C	180 μ (micron)	Silicone	Strong
Crepe	170°C	180 μ (micron)	Rubber	Malleable
Matte Cloth	80°C	0.3mm	Rubber	Strong
PTFE	260°C	80 μ (micron)	Silicone	Frictionless



Alloy Wheel
Masking Discs



Masking Kits



Masking Caps



Masking Plugs



Masking Hooks



Masking Discs



Custom Die Cut
Shapes

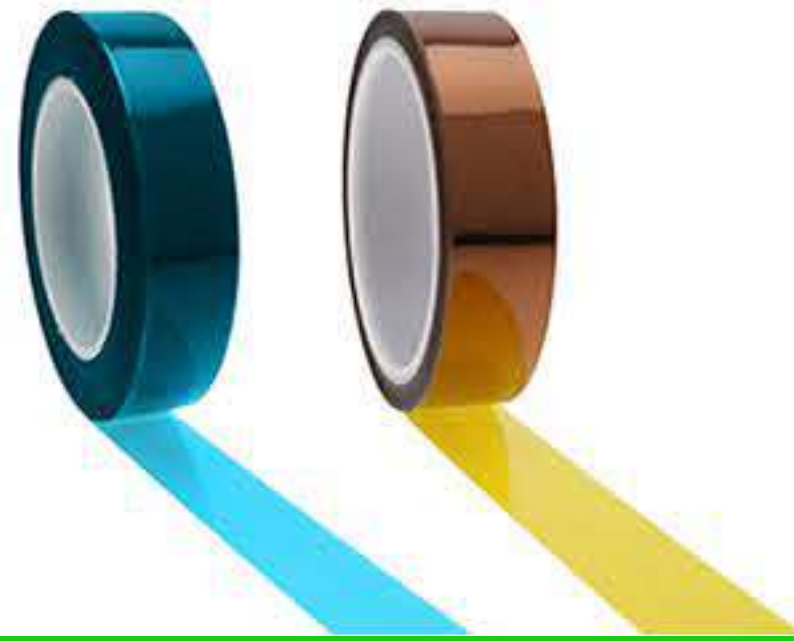

Masking Tapes



Silicone Flange Plugs

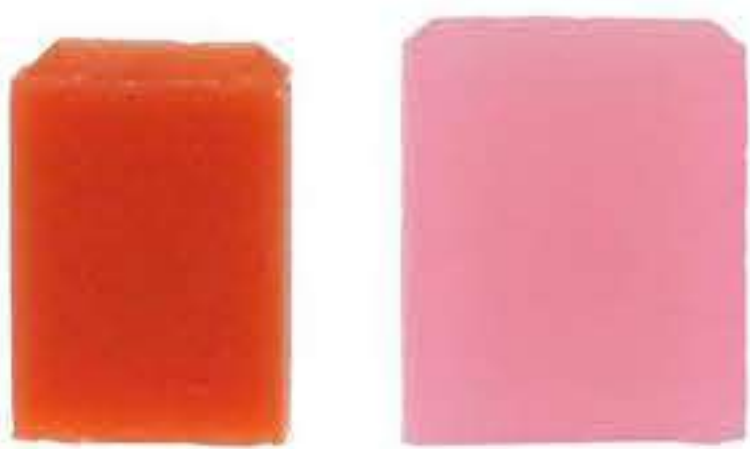

Silicone Rectangular
Covers



Silicone Washer
Caps

Alloy Wheel Masking Discs

Product Code: **ALLOY**

145mm - 200mm

- ✓ Manufactured from High Temp Crepe Paper
- ✓ Covers the rear wheel hub during coating
- ✓ Rubber pressure adhesive backing
- ✓ Temperature tested up to 160°C



High Temp Masking Kits

Starter Kit

Product Code: **KIT003**

2.7mm - 18.54mm

- ✓ Temperature resistant silicone to 315°C
- ✓ 12 different sizes of caps and plugs
- ✓ Selection of Caps and Plugs
- ✓ Great starter option

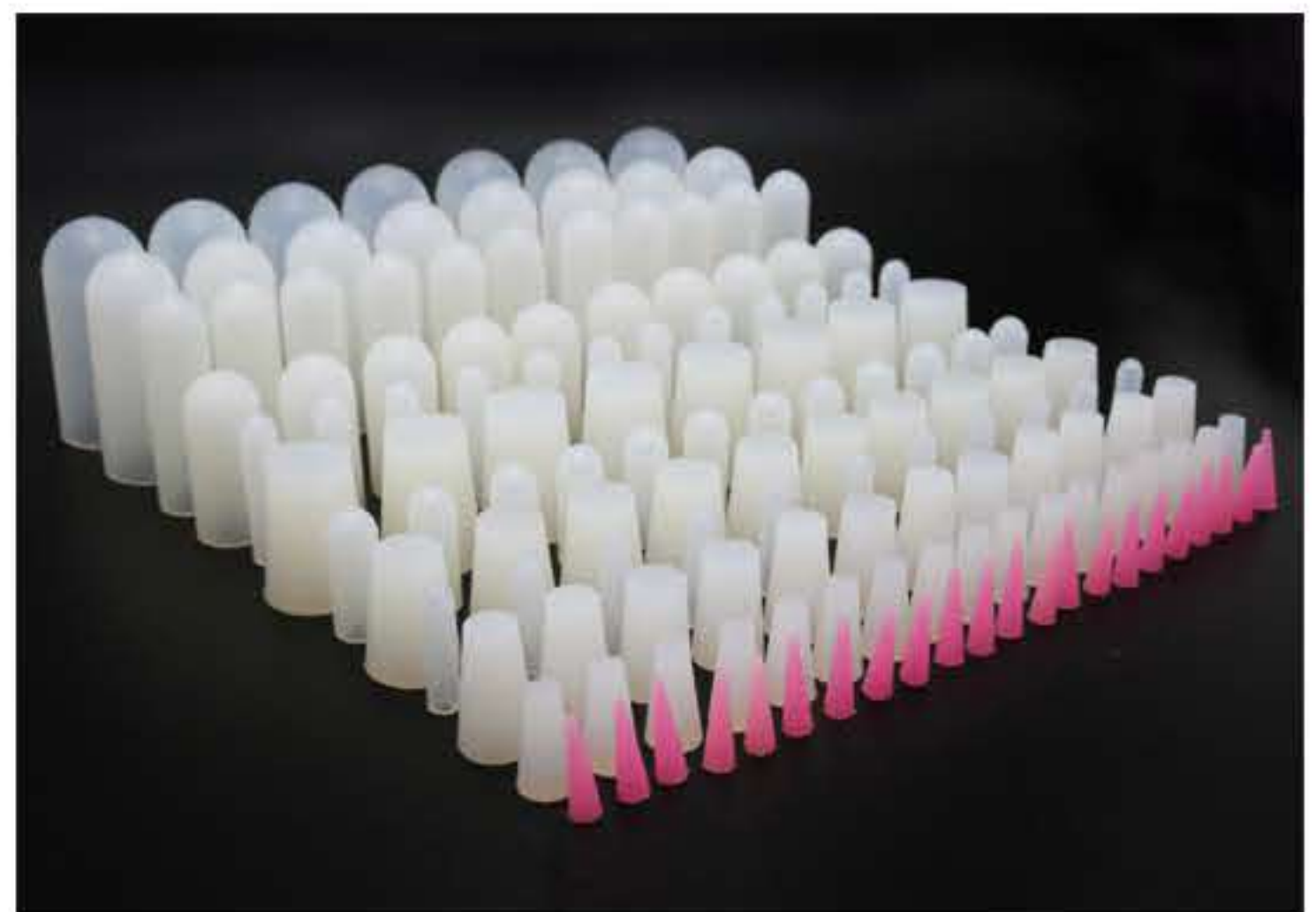

Complete Kits

Product Code: **KIT**

1.6mm - 38mm

- ✓ Temperature resistant silicone to 315°C
- ✓ Precision or Complete Kits available
- ✓ Selection of Caps, Plugs, and Tapes
- ✓ Great value for money



Cap Kits

Product Code: **KIT**

2.3mm - 18.54mm

- ✓ Temperature resistant silicone to 315°C
- ✓ 80pc, 100pc and 150pc options
- ✓ Range of options
- ✓ Range of sizes

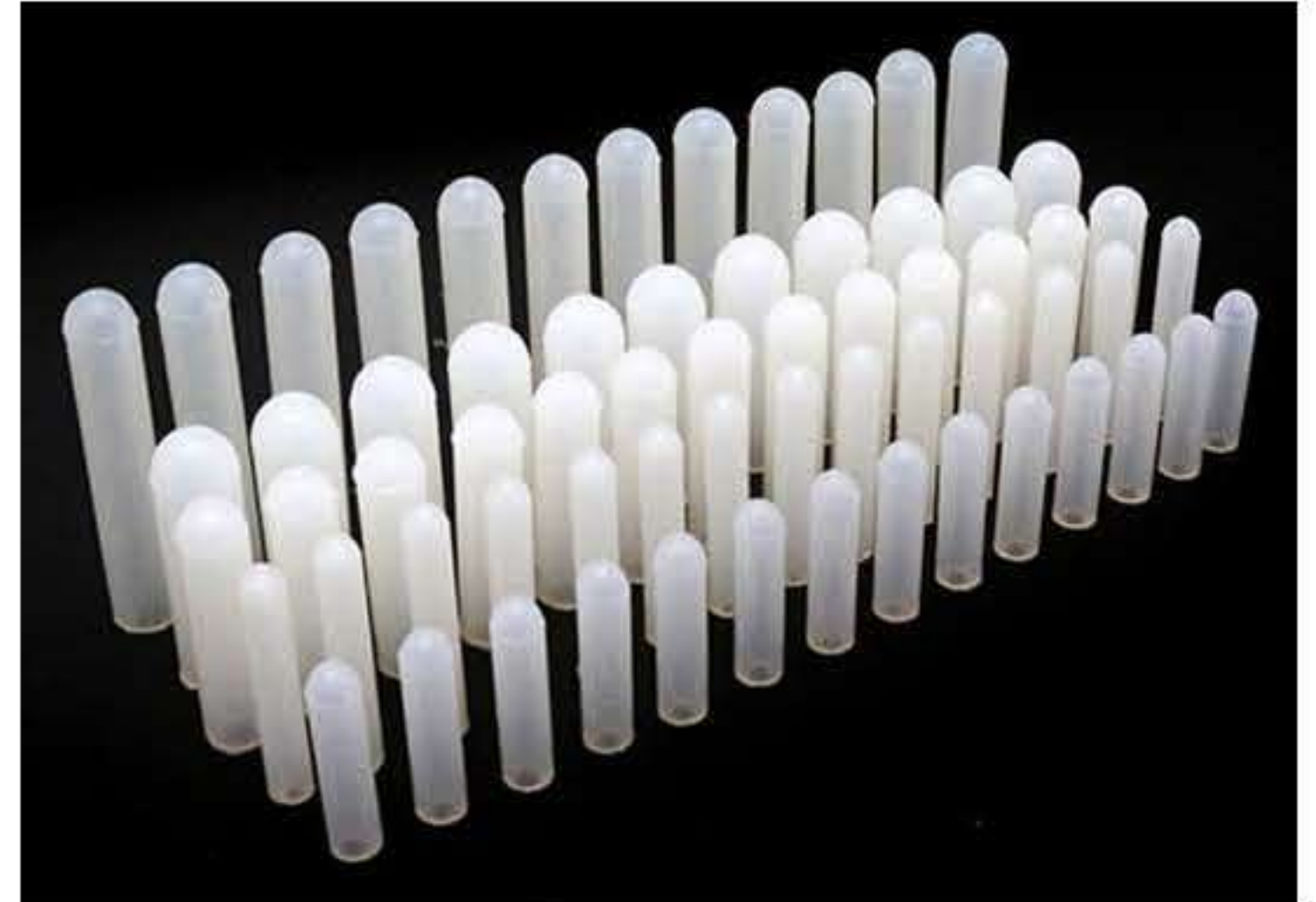

Plug Kits

Product Code: **KIT**

1.6mm - 53.98mm

- ✓ Temperature resistant silicone to 315°C
- ✓ Great for masking off holes
- ✓ 7 different options of Kits
- ✓ EPDM Plug Kit available

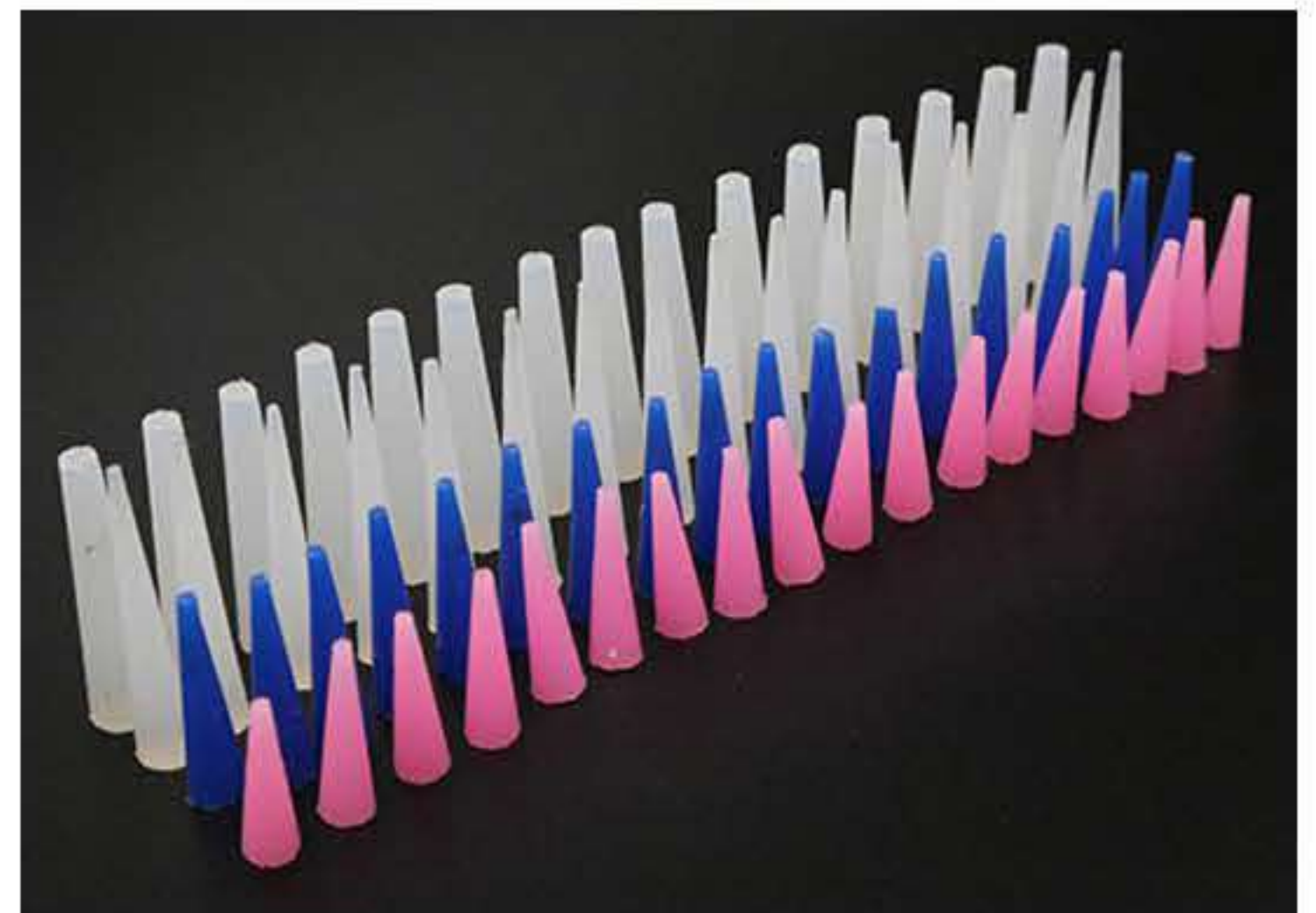

Tape Kits

Product Code: **KIT**

3.2mm - 50mm

- ✓ Precision Kit: 3.2mm, 9.5mm, 12.7mm, 6mm
- ✓ Available with Polyester or Polyimide Tape
- ✓ General Kit: 12.7mm, 25.4mm, 50mm
- ✓ General and Precision Kits available



Silicone Caps

Product Code: **SIC**

0.89mm - 53.47mm

- ✓ High temperature resistant up to 315°C
- ✓ Perfect for all masking purposes
- ✓ Resistant Silicone rubber
- ✓ Versatile solution



EPDM Caps

Product Code: **EPC**

0.89mm - 53.47mm

- ✓ High temperature resistant up to 215°C
- ✓ Manufactured from a premium EPDM
- ✓ Great resistance to Acids and Alkalis
- ✓ Versatile, can be stretched



Silicone Plugs

Product Code: **STP**

2.54mm - 127mm

- ✓ High temperature resistant up to 315°C
- ✓ Easily seals and protects excess holes
- ✓ Tapered to fit a range of widths
- ✓ Perfect for masking



EPDM Plugs

Product Code: **ETP**

1.6mm - 127mm

- ✓ High temperature resistant up to 215°C
- ✓ Manufactured from a premium EPDM
- ✓ Great resistance to Acids and Alkalis
- ✓ Tapered to fit range of sizes



Masking Hooks

Product Code: **C/V/S**

1.2mm - 10mm

- ✓ Manufactured from a Copper Plated Steel
- ✓ Range of sizes, lengths and widths
- ✓ Excellent for painting, coating, etc.
- ✓ Available in C / V / S variations



Polyester Discs

Product Code: **HID**

3mm - 150mm

- ✓ Manufactured from Green Polyester Film
- ✓ High temperature resistant up to 220°C
- ✓ Specially formulated adhesive
- ✓ Ideal for masking

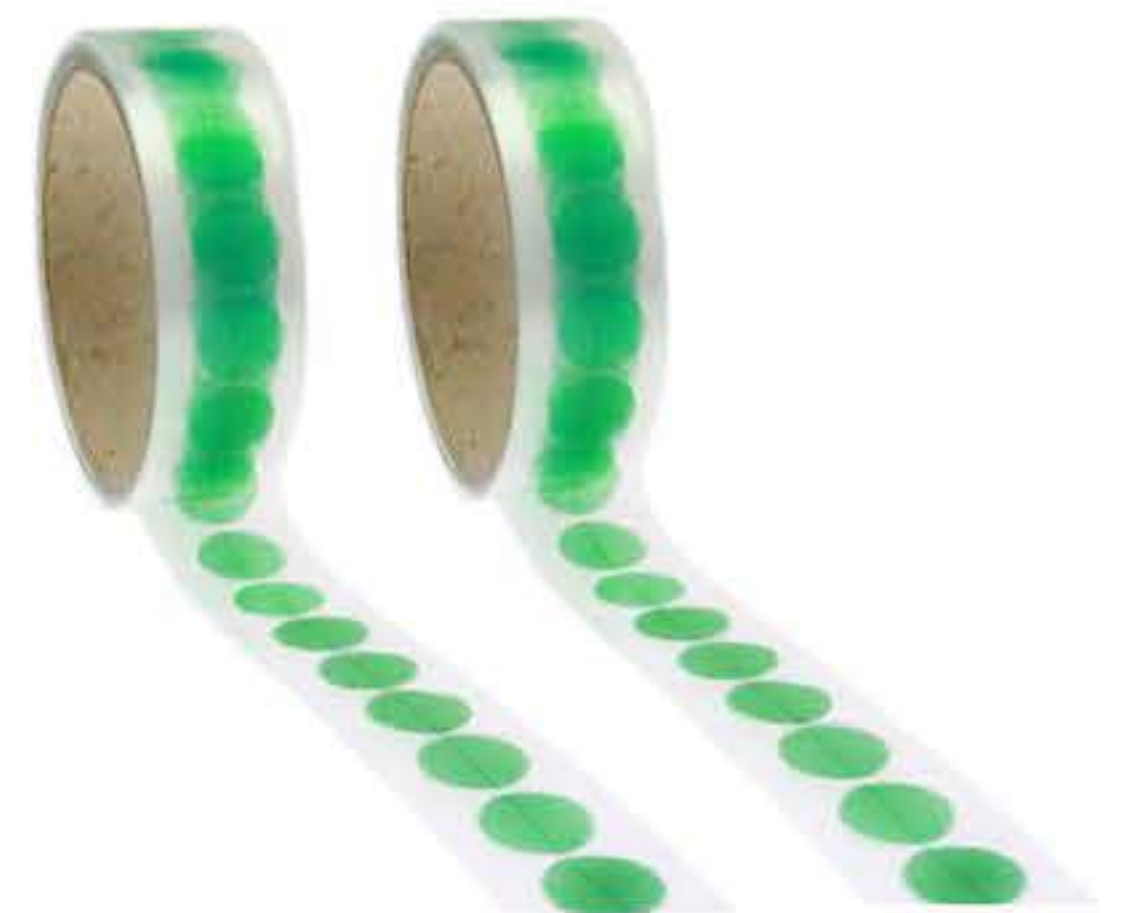

Polyimide Discs

Product Code: **ULD**

3mm - 150mm

- ✓ Ultra high temperature resistant up to 260°C
- ✓ Strong and versatile physical properties
- ✓ Perfect for all kinds of masking uses
- ✓ Can be cut to fit

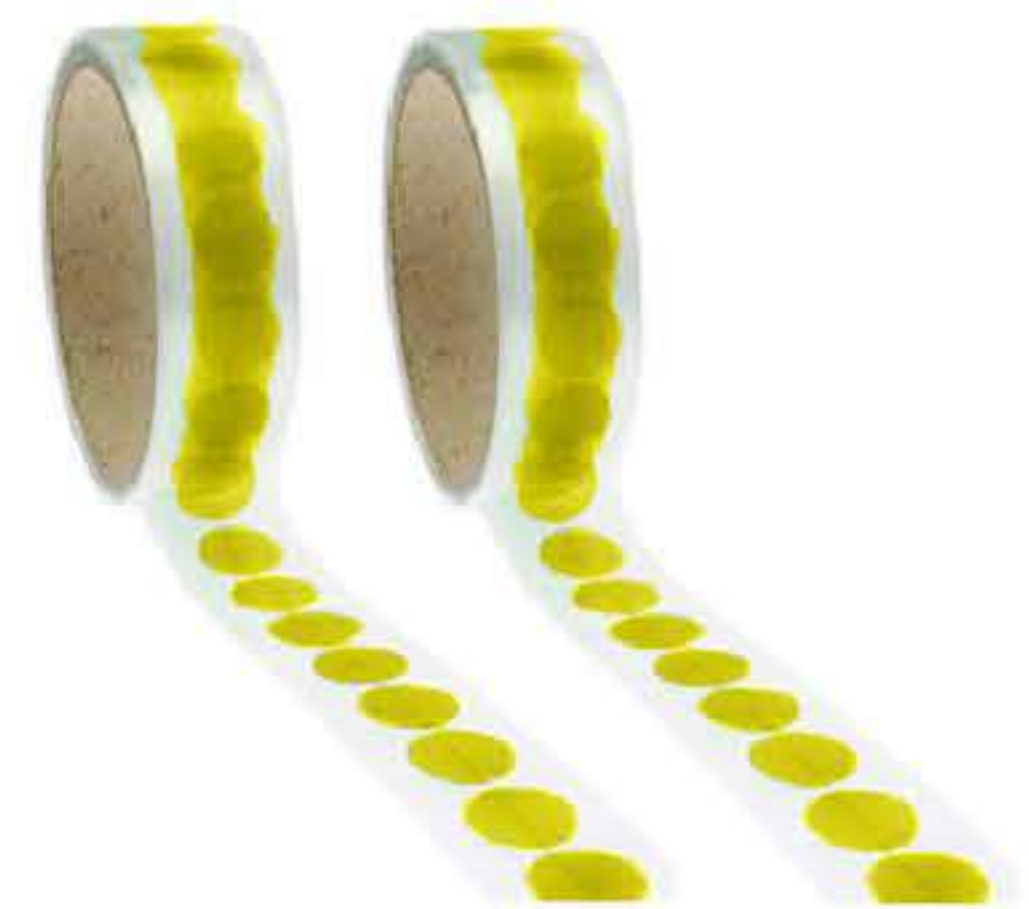

Custom Die Cut Shapes

Product Code: **DIE-CUTS**

1mm+

- ✓ We have the ability in house to cut to your requirements
- ✓ Available across our full range of Masking Tapes
- ✓ Call us now to enquire on 01233 713 581
- ✓ Cut to any shape you require



Green Polyester Tape

Product Code: **HIT**

3.2mm - 250mm

- ✓ Available as lightweight 25 micron tape
- ✓ High temperature resistant up to 220°C
- ✓ Ideal for anodising/powder coating
- ✓ Specialized Silicone adhesive

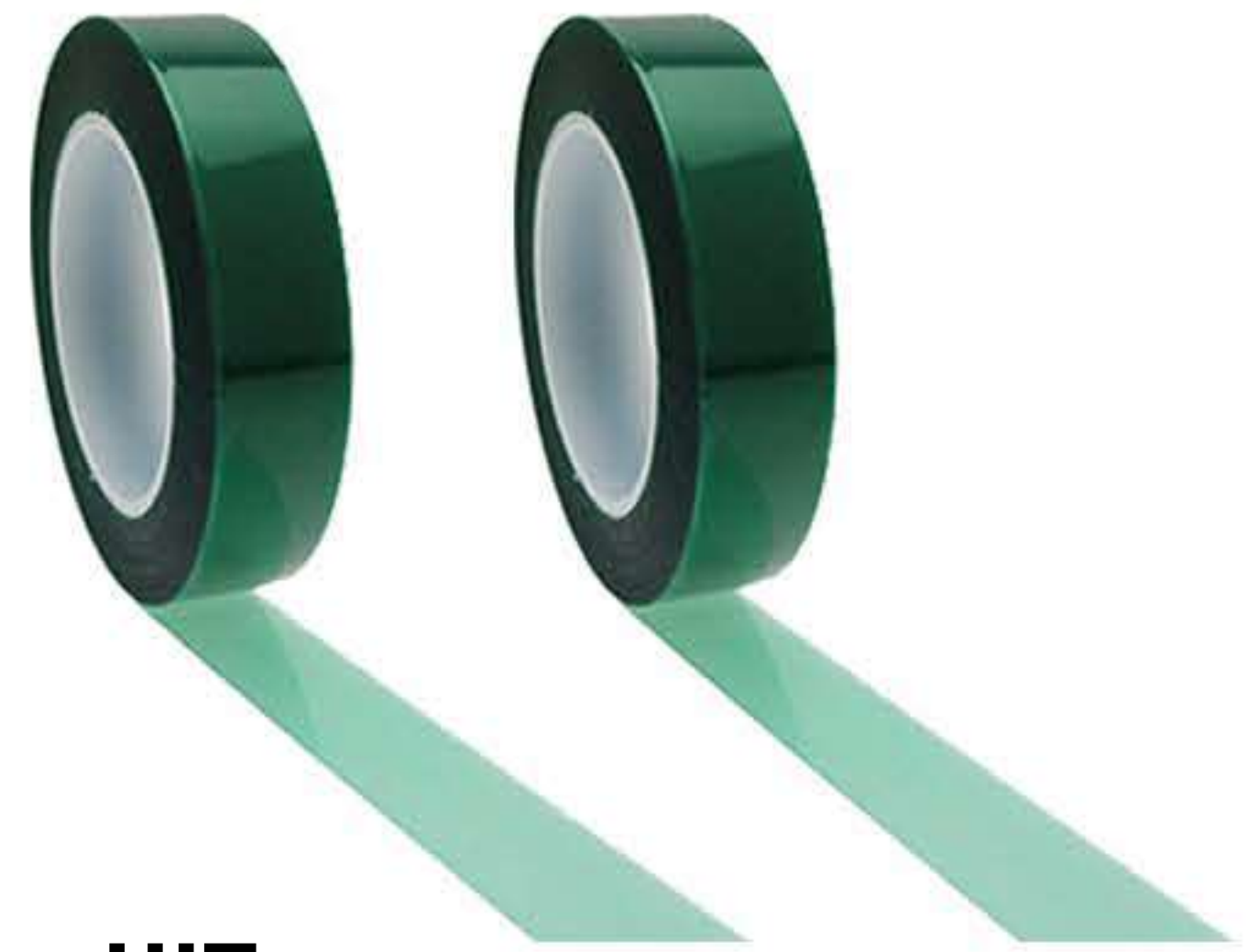

Blue & Red Polyester Tape

Product Code: **HIT**

3.2mm - 250mm

- ✓ Manufactured from Blue or Red Polyester
- ✓ High temperature resistant up to 230°C
- ✓ Silicone adhesive backing
- ✓ For all masking uses

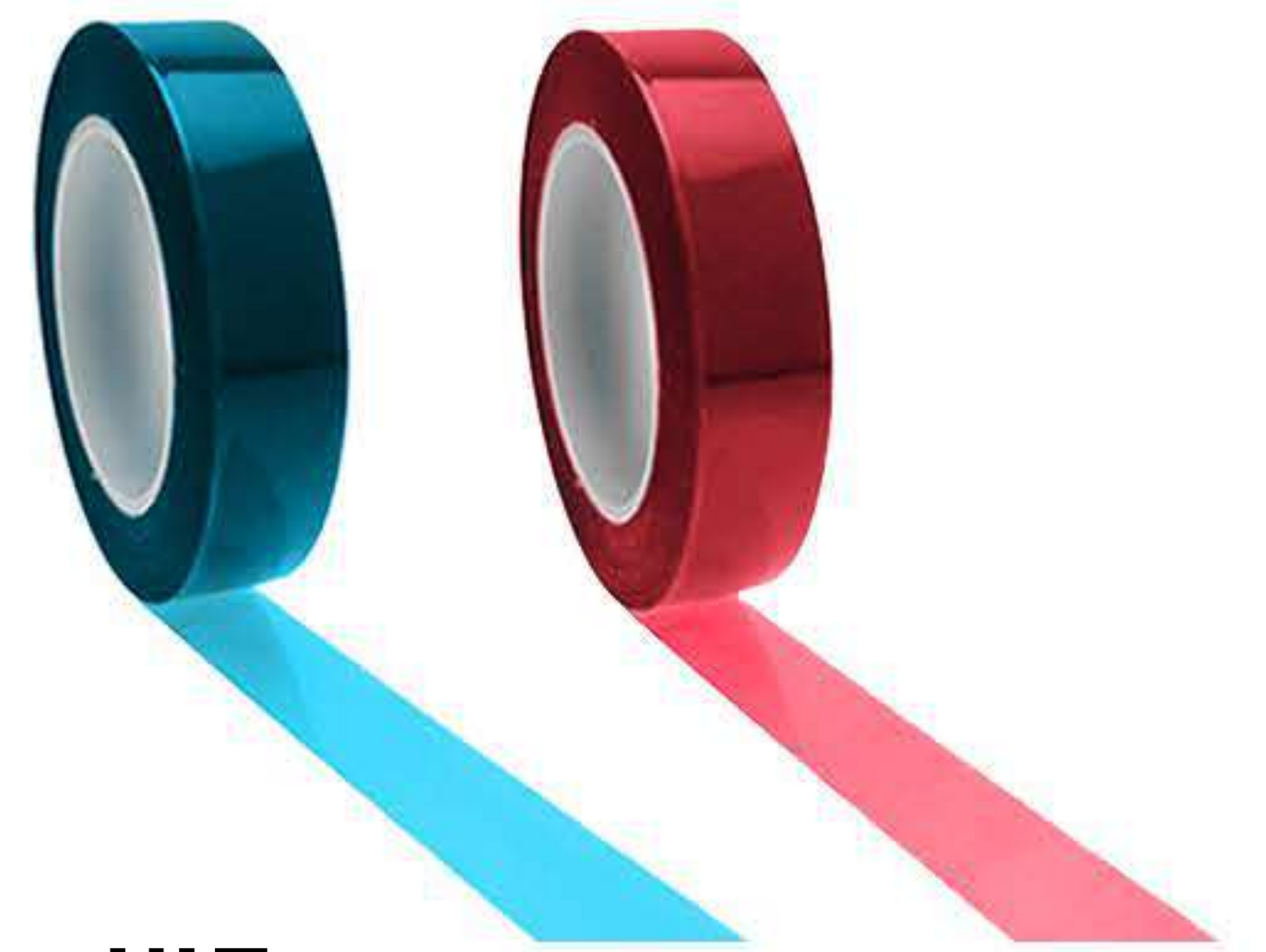

Amber Polyimide Tape

Product Code: **ULT**

3.2mm - 250mm

- ✓ Ultra high temperature resistant up to 260°C
- ✓ Versatile form of masking tape
- ✓ Strong adhesive backing
- ✓ Can be used with coils

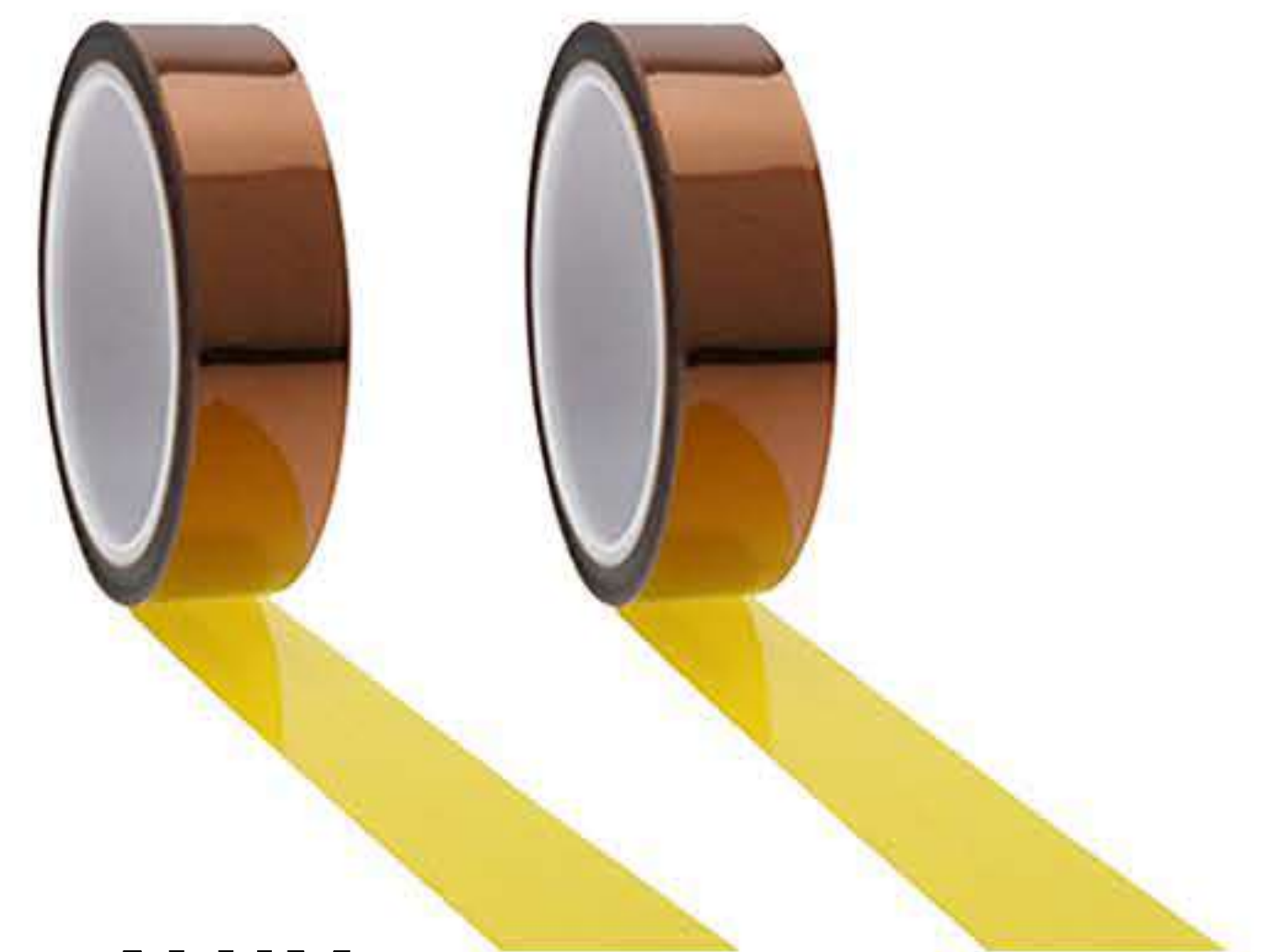

Aluminium Foil

Product Code: **ALUM**

3mm - 250mm

- ✓ Chemical and moisture resistant Aluminium
- ✓ Reflects both light and heat
- ✓ For specialist applications
- ✓ Thermally conductive



Glass Cloth Tape

Product Code: **SHOT**

3mm - 250mm

- ✓ High temperature resistant up to 180°C+
- ✓ Robust blasting/fabrication tape
- ✓ Backed with a Silicone adhesive
- ✓ Abrasion resistant



High Temp Crepe Tape

Product Code: **CRP**

3mm - 50mm

- ✓ Manufactured from a strong Crepe Paper
- ✓ High temperature resistant up to 170°C
- ✓ Strong Silicone adhesive
- ✓ No residue

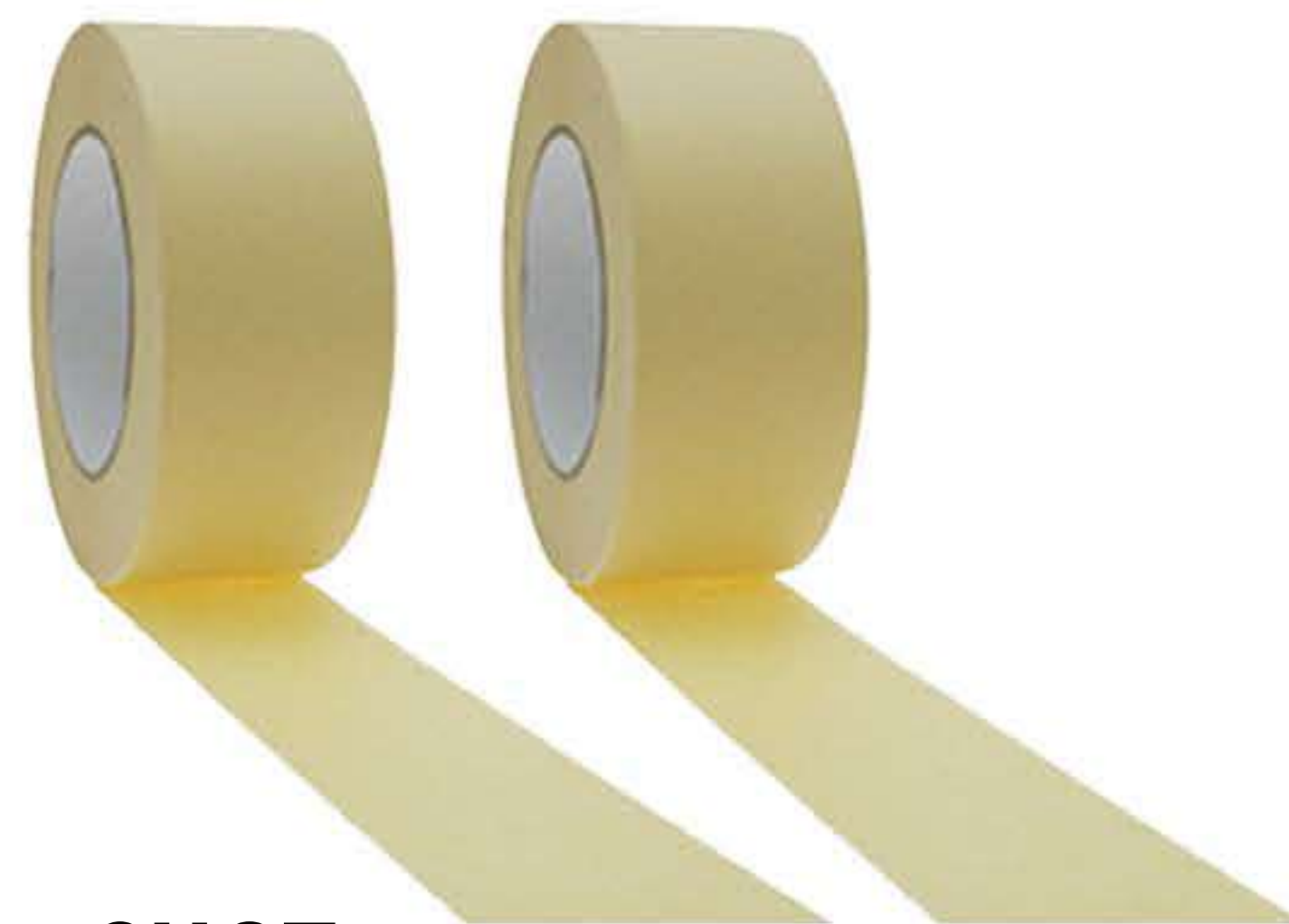

Matte Cloth Tape

Product Code: **SHOT**

50mm

- ✓ Reliable closely woven saturated Polythene
- ✓ Premium high bonding adhesive
- ✓ For Sandblasting / grit-blasting
- ✓ Multiple resistance properties



PTFE Tape

Product Code: **HIT**

5mm - 50.8mm

- ✓ High temperature resistant up to 180°C
- ✓ Manufactured from frictionless PTFE
- ✓ Silicone adhesive backing
- ✓ High tensile strength



Silicone Double Flange Plugs

Product Code: **DPP**

M6 - M18

- ✓ Manufactured from high temperature silicone
- ✓ Resistant to up to 315°C of heat
- ✓ Available in a range of colours
- ✓ Great for masking



Silicone Flange Plugs

Product Code: **FPL**

7.4mm - 18mm

- ✓ Manufactured from high grade silicone rubber
- ✓ High temperature resistant up to 315°C
- ✓ Great for masking purposes
- ✓ Colour coded



Silicone Thread Mask Plugs

Product Code: **TMP**

M3 - M30

- ✓ Manufactured from high temperature silicone
- ✓ Capable of withstanding up to 315°C
- ✓ Designed for threaded holes
- ✓ Easy to install and remove



Silicone Rectangular Covers

Product Code: **RCOV**

3mm - 250mm

- ✓ Manufactured from high temperature silicone
- ✓ Capable of withstanding up to 315°C
- ✓ Common sizes available
- ✓ Colour options stocked

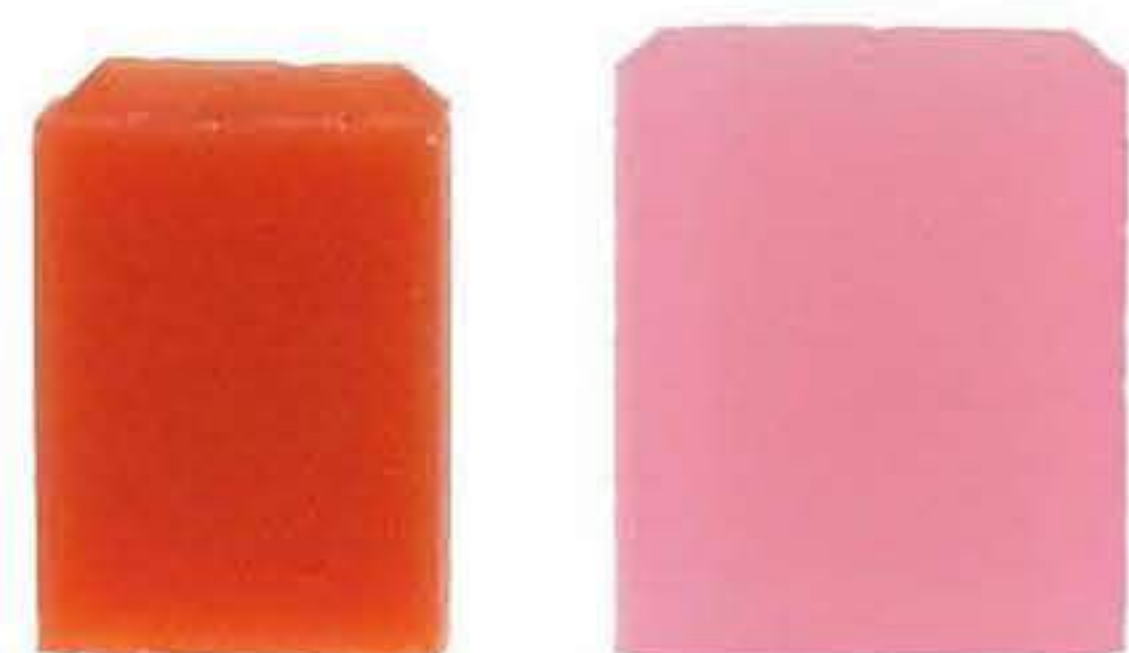

Silicone Step Plugs

Product Code: **STEP**

5mm - 12.4mm

- ✓ Manufactured from high temperature silicone
- ✓ Withstands temperatures up to 315°C
- ✓ Great for all masking purposes
- ✓ Colour coded by size



Silicone Washer Caps

Product Code: **WC**

M3 - M20

- ✓ Manufactured from high temperature silicone
- ✓ High temperature resistant up to 315°C
- ✓ Range of sizes available
- ✓ Colour coded



Adjustable Feet are offered in over **17 different styles** with unique properties, from **Anti Vibration** to a **Tilting Base**. We understand that sometimes too much choice is confusing, which is why we offer a selection of **ready to install sets** for easy match up with your application, along with a number of useful resources.

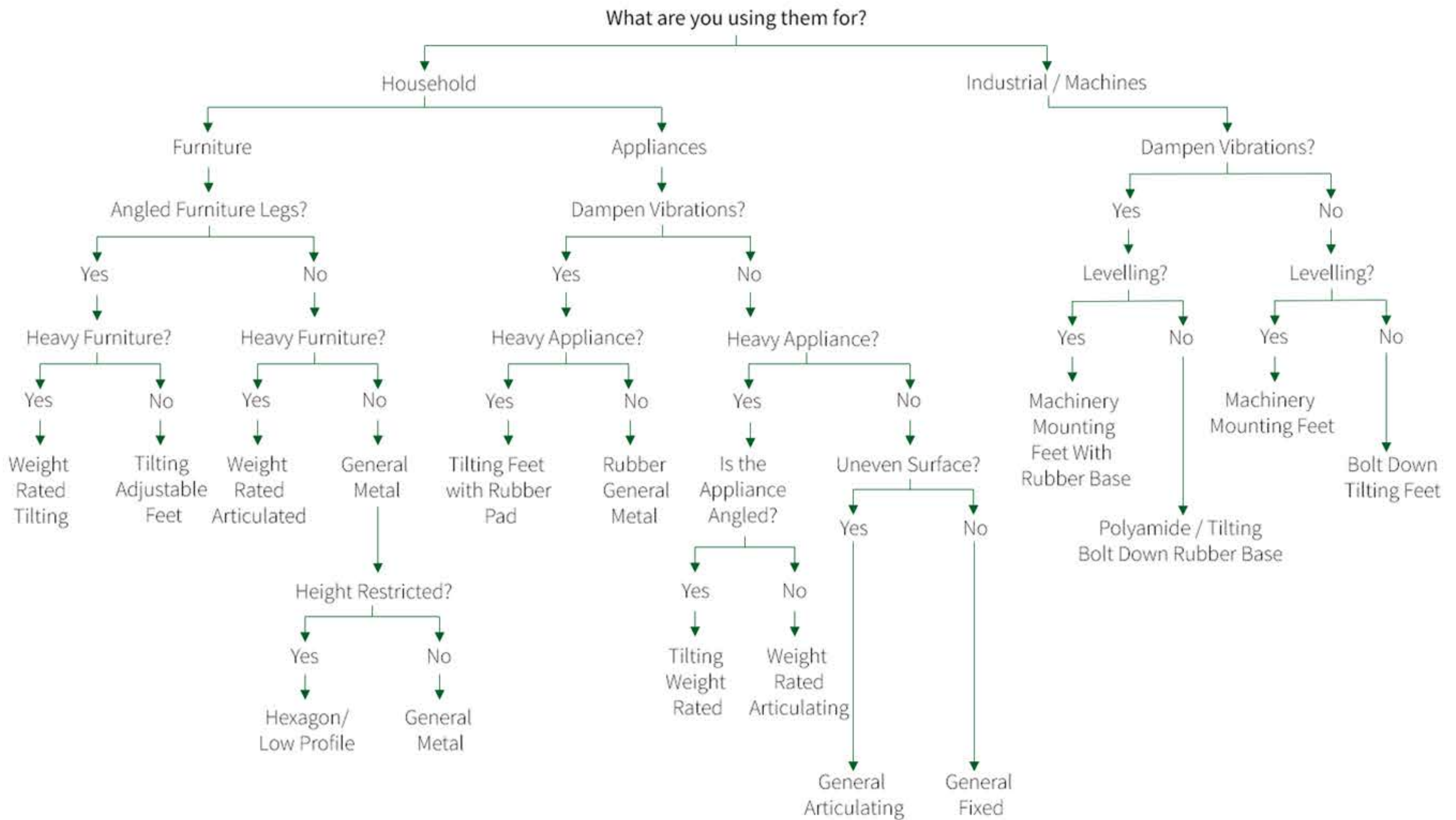

Adjustable Feet



General Adjustable Feet



Slotted Head Adjustable Feet



Low Profile Adjustable Feet



Weight Rated Articulating Feet



Rubber Adjustable Feet



Weight Rated Tilt Glide Feet



Polyamide Adjustable Feet



One Piece Adjustable Feet



Metal Adjustable Feet



Stainless Steel Covered Feet



Allen Key Feet

Adjustable Feet



Tilting Adjustable Feet



Machinery Mounting Feet



Stainless Adjustable Feet



Washing Machine Feet



Hexagon Adjustable Feet



Economic Adjustable Feet



Ready To Install Sets



Teflon Adjustable Feet

How To Measure Adjustable Feet:

When measuring Adjustable Feet, it is important to have a good idea of the key requirements that will enhance the day-to-day performance. Also, it is important to hold a consideration for weight capabilities. Outlined within the image below are the most important parts to consider when measuring up your Adjustable Feet.

1. Base Diameter: To find the base diameter of the foot, you should measure the size across the base as labelled within the diagram.

2. Thread Length: The thread length of an adjustable foot is often the distance between the stud and bolt. The stud is the part labelled 'thread size'. The bolt is the section where the thread joins the base.

3. Thread Size: To find the metric thread size of a foot, you should start by measuring the diameter across the thread. This can be done by putting the ruler against the stud of the adjustable foot (labelled thread size in diagram) and taking the measurement in millimetres.



Thread Size

Thread Length

Base Diameter



Adjustable Feet

General Adjustable Feet

Product Code: **ADJ**

M6 - M12

- ✓ Manufactured with a reinforced Nylon Base
- ✓ Articulating or fixed bases available
- ✓ Ideal for medium to heavy uses
- ✓ Metric threaded male studs



Slotted Head Adjustable Feet

Product Code: **GAMF+GFMF**

M6 - M12

- ✓ Manufactured with a reinforced Nylon Base
- ✓ Articulating / fixed bases available
- ✓ Ideal for medium to heavy uses
- ✓ Slotted head for adjustment



Low Profile Adjustable Feet

Product Code: **LOW**

M5 - M10

- ✓ Manufactured with a Nylon or Polyethylene base
- ✓ Available in a range of small thread lengths
- ✓ For use with height restricted applications
- ✓ Good level of grip strength



Weight Rated Articulating Feet

Product Code: **WFMF**

M8 - M12

- ✓ As mounts for machinery and conveyors
- ✓ Heavy duty reinforced Nylon base
- ✓ Steel alloy Stud and male thread
- ✓ Weight rating of up to 2000kg



Adjustable Feet

Rubber Adjustable Feet

Product Code: **WAMF**

M6 - M12

- ✓ Excellent vibration and shock dampening properties
- ✓ Available in Tapered, Straight or Octagonal bases
- ✓ Manufactured from a premium Rubber/Nitrile
- ✓ For stabilizing Furniture or Machinery



Weight Rated Tilting Feet

Product Code: **ADJ**

M6 - M12

- ✓ Produced with a reinforced Nylon base
- ✓ Premium Steel alloy thread and Stud
- ✓ Ball joint base allows for tilt
- ✓ Weight rated up to 2000kg



Polyamide Adjustable Feet

Product Code: **ADJ**

M8 - M10

- ✓ Manufactured with a Polyamide for the base
- ✓ Available in Zinc or Stainless Steel threads
- ✓ Allen key height adjustment from above
- ✓ Excellent weight rating - 500-600kg



One Piece Adjustable Feet

Product Code: **OPF**

25mm - 80mm

- ✓ Manufactured using a reinforced Nylon
- ✓ Height adjusted to meet requirements
- ✓ Available for round and square tubes
- ✓ One piece solution



Adjustable Feet

Metal Adjustable Feet

Product Code: **ADJ**

M8 - M10

- ✓ Manufactured from a strong Zinc Plated Steel
- ✓ Ideal for machinery or appliances
- ✓ Available in bolt down / standard
- ✓ Weight rated up to 650kg per foot



Tilting Adjustable Feet

Product Code: **ADJ**

M8 - M20

- ✓ Excellent for use with Machinery & Conveyors
- ✓ Available in Standard or Bolt-down variants
- ✓ Allows for a thread tilt up to 20°
- ✓ Good for angled applications



Machinery Mounting Feet

Product Code: **MMF**

M16 - M20

- ✓ Manufactured using a strong galvanized Steel
- ✓ Comes with bolt holes for securing
- ✓ Rubber padded base available
- ✓ Allows for 8° of articulation



Stainless Adjustable Feet

Product Code: **ADJ**

M10 - M30

- ✓ Manufactured using Stainless Steel & Rubber
- ✓ Meets USDA food hygiene guidelines
- ✓ Rubber base for additional grip
- ✓ Levelling base up to 5°



Adjustable Feet

Washing Machine Feet

Product Code: **WAMF**

M10

- ✓ Manufactured from a premium EPDM Shore A 70
- ✓ Helps to reduce vibration and noise
- ✓ Screw in replacement for washing machines
- ✓ Ideal load rating of 200kg



Hexagon Adjustable Feet

Product Code: **ADJ**

M8 - M12

- ✓ Manufactured from a strong HDPE or Nylon
- ✓ Unique six point hexagon base
- ✓ Ideal for medium weights
- ✓ Excellent level of stability



Economic Adjustable Feet

Product Code: **ADJ**

M4 - M12

- ✓ Made from Polypropylene & Zinc Plated Steel
- ✓ Available in Black & White
- ✓ Great for both light and medium uses
- ✓ Thread lengths up to 100mm



Ready To Install Sets

Product Code: **ADJ**

M4 - M12

- ✓ Quick solution for common Adjustable Feet uses
- ✓ For Mounting: Brackets & Matching Feet
- ✓ For Wood: Wood Fixings & Matching Feet
- ✓ For Tubes: Threaded Insert & Matching Feet



Adjustable Feet

Teflon Adjustable Feet

Product Code: **ADJ**

M6 - M10

- ✓ Manufactured from a premium Teflon & Steel
- ✓ Recommended for carpet, wood, and tile
- ✓ Great for use as Glides or Sliders
- ✓ Metric thread sizes available



Stainless Steel Covered Feet

Product Code: **ADJ**

M8 - M10

- ✓ Manufactured from Stainless Steel & Polypropylene
- ✓ With or without allen key slot at the top of thread
- ✓ Weight ratings of up to 550kg per foot
- ✓ Range of metric thread sizes



Allen Key Feet

Product Code: **ADJ**

M6 - M10

- ✓ Zinc Plated Steel & Polyamide or Polypropylene base
- ✓ Available with either a fixed or swivel base
- ✓ Complete with allen key slotted head
- ✓ Large range of sizes available



Weight Guide For Adjustable Feet:

Many of our Adjustable/Threaded Feet variants come with a specified weight rating. This is where they are tested up to a particular level, proving beneficial for heavy uses where an idea of their performance is key. Our table below shows the weight ratings of our Weight Rated Feet. However, we also show ratings on many other products inside our range.

Weight Rating	Model
Up to 50kg	Weight Rated Articulating - 25mm Base
Up to 75kg	Weight Rated Articulating - 32.5mm Base
Up to 100kg	Weight Rated Articulating - 40mm Base
Up to 250kg	Weight Rated Articulating - 47.5 & 55mm Base
Up to 500kg	Weight Rated Fixed - 25mm Base
Up to 750kg	Weight Rated Fixed - 37.5mm Base
Up to 750kg	Weight Rated Articulating - 100mm Base
Up to 1000kg	Weight Rated Fixed - 47.5mm Base
Up to 2000kg	Weight Rated Fixed - 80mm Base



Cable Management products are popularly used by a range of professionals, from Electricians to DIY Enthusiasts looking to **renovate a home**. Offering a **high quality finish and aesthetic designs**, we offer a solution for almost every eventuality.



Product	Used For
Cable Glands	Providing strain relief and holding cable position
Rubber Grommets	Managing, protecting and sealing cables from damage
Snap Fit Bushes	Managing and protecting cables from damage
Blanking Plugs	Blanking off holes in a wall or panel
Desk Cable Tidies	Organizing and threading desk cables
Cable Clamps	Organising wires in dense areas
Heatshrink Tubing	Protecting / joining wires or concealing exposed connections
Heatshrink Caps	Sealing off frayed cable connections
Cable Tie Mounts	Management of cables and wires



Cable Glands



Rubber Grommets



Snap Fit Bushes



Desk Cable Tidies



Cable Clamps



Heatshrink Tubing 2:1



Heatshrink Tubing 3:1



Adhesive Lined Heatshrink



Heatshrink Caps



Cable Ties



Strain Relief Bushings



Snap In Cable Glands



Standard Strain Relief



Lockit Strain Relief



Strain Relief Pliers

Metric / PG Cable Glands

Product Code: **CLG**

M12 - M32

- ✓ Manufactured from Nylon & Nitrile Rubber
- ✓ Comes with a matching locking nut
- ✓ Metric and PG type threads
- ✓ IP 68 rated product



Flex-Protecting Cable Glands

Product Code: **CBG**

M12 - M25

- ✓ Manufactured from a Nylon & Nitrile Rubber
- ✓ Flexible area prevents cable from bending
- ✓ Comes with lock nuts
- ✓ IP 68 rated product



Closed Rubber Grommets

Product Code: **CLG**

6.4mm - 42mm

- ✓ Manufactured from a quality PVC/TPE
- ✓ Closed mid section to prevent ingress
- ✓ Provides an quality seal
- ✓ Flame retardant



Open Rubber Grommets

Product Code: **OPG**

5mm - 52mm

- ✓ Manufactured from a highly resistant EPDM
- ✓ Ideal for protecting and threading cables
- ✓ Provides a quality air tight fitting
- ✓ Flame retardant properties



Quick Fit Rubber Grommets

Product Code: **GRM**

10mm - 28mm

- ✓ Produced using a high quality PVC/TPE
- ✓ Quick solution for cable management
- ✓ Simple push fitting Grommet
- ✓ Perfect for Electronics uses



Stepped Rubber Grommets

Product Code: **GRM**

12.7mm - 26mm

- ✓ Manufactured from a premium Black PVC
- ✓ Protects wires, cables and pipes
- ✓ Fits a range of diameters
- ✓ Durable and resistant



Open / Closed Bushes

Product Code: **SFB**

7mm - 38.1mm

- ✓ Manufactured from a premium Nylon 6/6
- ✓ Fits a range of cable widths
- ✓ Protects exposed wires
- ✓ Open/Closed design



Snap Fit Bushes

Product Code: **SFB**

4mm - 100mm

- ✓ Manufactured from a heat stabilized Nylon
- ✓ For a wide range of panel thicknesses
- ✓ Available in Black & White
- ✓ Ideal for threading cables



Universal Bushes

Product Code: **UNB**

7mm - 27mm

- ✓ Anti rattle design reduces cable vibration
- ✓ Made from a high quality Nylon
- ✓ Fits a range of cable widths
- ✓ Fixing clips for security



Universal Open / Closed Bushes

Product Code: **SFB**

7mm - 38.1mm

- ✓ Open design that can be retrofitted to cables
- ✓ Manufactured from a high quality Nylon
- ✓ Fixing clips for easy installation
- ✓ Perfect for cable protection



Desk Cable Tidies

Product Code: **DCT**

60mm - 80mm

- ✓ Manufactured from a strong LDPE
- ✓ Perfect for protecting/organizing
- ✓ Ideal for offices and desks
- ✓ Easy to fit design



Heat Shrink Tubing 2:1

Product Code: **HST**

1.2mm - 25.4mm

- ✓ Manufactured from a high quality Polyolefin
- ✓ Sleeves to join or connect two wires
- ✓ Shrinks to fit at a ratio of 2:1
- ✓ Multiple uses per unit



Heat Shrink Tubing 3:1

Product Code: **HST**

1.5mm - 39mm

- ✓ Manufactured from high quality Polyolefin
- ✓ Shrinks to fit all applications at 3:1
- ✓ Multi purpose product
- ✓ Insulates & protects



Adhesive Lined Heatshrink

Product Code: **HST**

3mm - 40mm

- ✓ Manufactured from a high quality Polyolefin
- ✓ Adhesive lined internal section
- ✓ Shrinks down to fit
- ✓ Insulates & protects



Heat Shrink Caps

Product Code: **HSC**

12mm - 160mm

- ✓ Made from durable Polyolefin
- ✓ Ideal for sealing off cables
- ✓ Good resistive properties
- ✓ Shrink to fit caps



Cable Tie Pin

Product Code: **CABM**

29mm

- ✓ Both permanent and temporary solutions
- ✓ For guiding or managing cables and wires
- ✓ Low price compared to other solutions
- ✓ Designed for use with cable ties



Saddle Cable Tie Mounts

Product Code: **CABM**

15.9mm - 25mm

- ✓ Manufactured from high quality Nylon
- ✓ Black and white colours in stock
- ✓ For general cable management
- ✓ Compatible with cable ties



Cable Tie Brackets

Product Code: **CABM**

50mm x 26mm

- ✓ Available in screw and self adhesive types
- ✓ Manufactured from a high strength Nylon
- ✓ Able to fit heavy duty cable ties
- ✓ Excellent for wall mounting



Cable Ties

Product Code: **CT**

50mm x 26mm

- ✓ Made from a high quality UL94V-2 rated Nylon 6/6
- ✓ Serrated internal section for improved grip
- ✓ Available in a range of sizes and colours
- ✓ Individual or pack sizes in stock



Liquid Tight Bushings

Product Code: **STRB**

7.1mm - 11.2mm

- ✓ Manufactured from a high quality Nylon 6/6
- ✓ Rounded interior edges for installation ease
- ✓ IP 65, 66, 67, and 68 rated
- ✓ UL listed



Snap In Pigtail Glands

Product Code: **STRB**

5.3mm - 39.6mm

- ✓ Snap into panel and self retains, no nut needed
- ✓ Flexible area prevents cable from bending
- ✓ UL and CSA certified
- ✓ IP 65 rated seal



Cable Clamps

Product Code: **PCL**

1/8" - 5/8"

- ✓ Manufactured from a high quality Nylon 6/6
- ✓ Aids cost effective cable management
- ✓ Perfect for clamping cables or wires
- ✓ Holds cable in position



Bell Mouth Strain Relief

Product Code: **STRB**

9.5mm - 15.9mm

- ✓ Absorbs shock and push/pull forces on a cable
- ✓ Manufactured from UL94V-2 rated Nylon 6/6
- ✓ Pliers required for max panel thickness
- ✓ Straight through cable design



Bushings For Non Round Holes

Product Code: **STRB**

11.5mm - 17.5mm

- ✓ Manufactured from a UL94V-2 rated Nylon 6/6
- ✓ Three finger 'lockit' design for snap fit
- ✓ Passes UL pull out test requirements
- ✓ For square or rectangular holes



RDD Right Angle Bushings

Product Code: **STRB**

15.9mm - 22.2mm

- ✓ Manufactured from a UL94V-2 rated Nylon 6/6
- ✓ Lockit' finger design for snap fit to a panel
- ✓ Suits double D holes to prevent rotation
- ✓ No installation tools required



RDD Flex Protect Bushings

Product Code: **STRB**

Multiple Sizes

- ✓ Manufactured from a UL94V-2 rated Nylon 6/6
- ✓ Multiple finger 'lockit' design for snap fit
- ✓ Passes UL pull out test requirements
- ✓ Nylon spring protects cable



Strain Relief Assembly Pliers

Product Code: **STRB**

Multiple Sizes

- ✓ High quality product with multiple adjustments
- ✓ Required to meet manufacturer specification
- ✓ Installation drawings available online
- ✓ For use during assembly



Nylon Grommet Strip

Product Code: **EDGE**

0.7mm - 2.7mm

- ✓ Manufactured from a high quality Nylon
- ✓ Temperature resistant 40°C to 85°C
- ✓ With or without an adhesive lining
- ✓ Serrated and unserrated available



Polyethylene Grommet Strip

Product Code: **EDGE**

0.9mm - 2.7mm

- ✓ Manufactured from a high quality Polyethylene
- ✓ Available in both Black or Natural finishes
- ✓ Comes in roll lengths of 30.5 metres
- ✓ Can be cut to fit



Fixings & Fasteners are stocked in a variety of **threaded and non-threaded options**, often manufactured from **Zinc Coated Steel, or Nylon 6/6**. Designed specifically for use with a variety of Furniture & DIY uses, you can rest assured that **we have the best option for your application**.



Product	Used For
Furniture Connector Nuts	Connecting furniture
Furniture Connector Bolts	Connecting furniture
Cross Dowel Barrel Nuts	Connecting and increasing the strength of furniture joints
Cam Bolt Fixing	Connecting with lock nuts to offer connection points
Cam Lock Nuts	Locking cam bolts into place
Furniture Fixing Brackets	Supporting heavy furniture
E-Nuts, D-Nuts & T-Nuts	Adding a thread to wooden furniture
Fir Tree Plugs	Offers lightweight fixings to secure / finish
P-Clip	Organising cables or holding them in position
Locking Wing Nut	Fixing threaded components in position
Nylon Thumbscrews	Screws to fix an object in position or tighten an application



Furniture Connector Nuts



Furniture Connector Bolts



Cross Dowel Barrel Nuts



Cam Bolt Fixings



Cam Lock Nuts



Furniture Fixing Brackets



Cone Shaped E-Nuts



D-Nuts



T-Nuts



Fir Tree Plugs



P-Clips



Locking Wing Nuts



Nylon Thumbscrews



Nylon Screws & Bolts

Furniture Connector Nuts

Product Code: **JCN**

M6 - M8

- ✓ Manufactured from a premium Steel Alloy
- ✓ Perfect pairing with connector bolts
- ✓ Simple to use threaded nut
- ✓ For connecting Furniture



Furniture Connector Bolts

Product Code: **JCB**

M6 - M8

- ✓ Manufactured from a strong Steel Alloy
- ✓ Simple screw fixing solution
- ✓ Excellent pairing with nuts
- ✓ For connecting furniture



Cross Dowel Barrel Nuts

Product Code: **BNUT**

M6 - M8

- ✓ Manufactured from a Zinc Plated Steel
- ✓ Nuts to increase the strength in a joint
- ✓ Cross dowel adjustable head
- ✓ Adjustable from above



Cam Bolt Fixings

Product Code: **CAM**

34mm

- ✓ Manufactured from a cost effective Turned Steel
- ✓ Available in metric and euro thread types
- ✓ Replacements for old or ineffective bolts
- ✓ For pairing with cam lock nuts



Cam Lock Nuts

Product Code: **CAM**

16mm - 19mm

- ✓ Manufactured from a premium Zinc Alloy
- ✓ For locking a threaded bolt in position
- ✓ For replacing old or worn cam nuts
- ✓ Locks a matching bolt in position



Furniture Fixing Brackets

Product Code: **ADJ**

M8 - M10

- ✓ Brackets to fix Adjustable Feet in position
- ✓ Manufactured from a Zinc Finished Steel
- ✓ Rust and weathering resistant
- ✓ Fixing Brackets



Cone Shapes E-Nuts

Product Code: **MTI**

M6 - M8

- ✓ Manufactured from a strong Silver Zinc Alloy
- ✓ Easily inserted in to wood or similar
- ✓ Used with both curved/flat surfaces
- ✓ Compatible with male threads



D-Nuts

Product Code: **MTI**

M4 - M10

- ✓ Manufactured from a high quality Zinc Alloy
- ✓ Good pairing with threaded feet
- ✓ Designed for use with wood
- ✓ Knock in for quick fixing

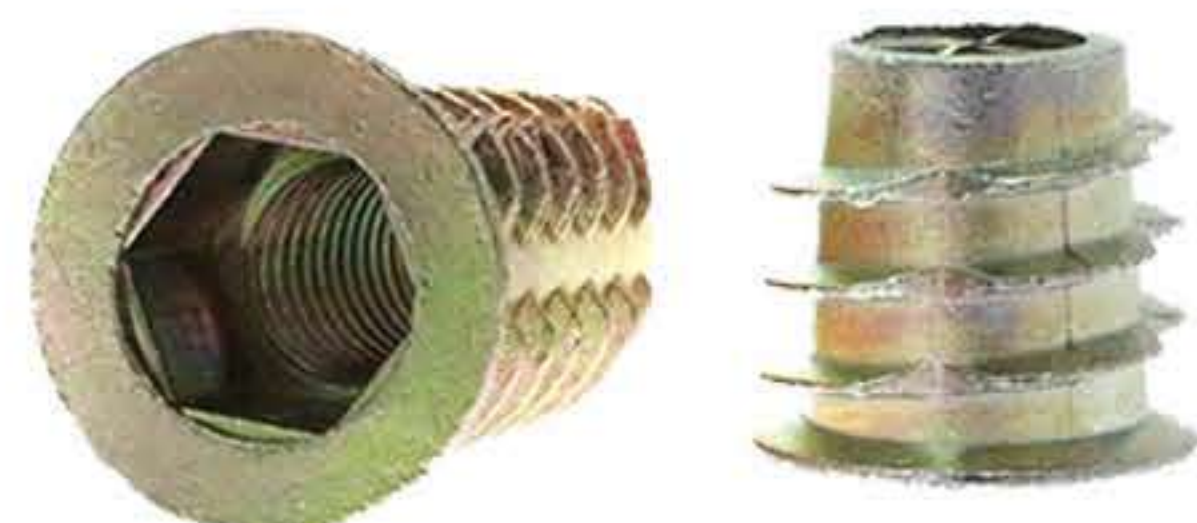

T-Nuts

Product Code: **MTI**

M6 - M10

- ✓ Manufactured from quality Steel Alloy
- ✓ For use with threaded components
- ✓ Pronged for a secure fitting
- ✓ Suitable for wood



Fir Tree Plugs

Product Code: **FTP**

3mm - 10mm

- ✓ Manufactured from a strong Nylon 6/6
- ✓ Durable and long lasting solution
- ✓ Locks panels into place
- ✓ Barbed for security



P-Clips

Product Code: **PCL**

1/8" - 5/8"

- ✓ Manufactured from a high quality Nylon 6/6
- ✓ To organize or thread exposed wires
- ✓ Available in a Natural or Black finish
- ✓ Perfect for clamping cables or wires



Locking Wing Nuts

Product Code: **WING**

M4 - M6

- ✓ Manufactured from a premium Nylon 6/6
- ✓ Available in both Natural & Black
- ✓ Locks in position for security
- ✓ Metric threaded



Nylon Thumbscrews

Product Code: **THUM**

M3 - M6

- ✓ Manufactured from a strong Nylon 6/6
- ✓ Can be used to tighten panels
- ✓ Available in Black or Natural
- ✓ Metric threaded



Nylon Screws & Bolts

Product Code: **THUM**

M2 - M24

- ✓ Hundreds of different size combinations
- ✓ Manufactured from quality nylon
- ✓ Range of head and drive types
- ✓ High performance solutions

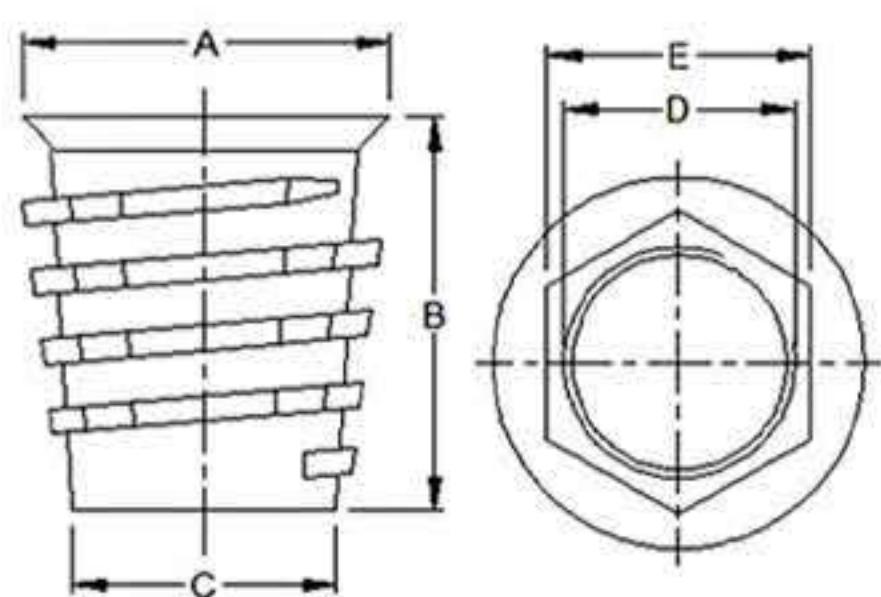



Need guidance on sizing?

We have **thousands of line drawings** on our website which can be found on the relevant product page by clicking on the **line drawing button**.



We offer a **vast array of Rubber Profiles** for both **commercial and consumer** uses, manufactured from **high strength, resilient materials** to offer **optimal properties**. From generic U Profiles to **custom made** Door Trims with Steel Reinforced ribs, we keep a large stock of these solutions.

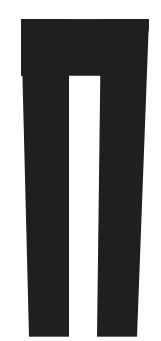

Profile	Material	Properties
	EPDM Rubber	'U' channel for easy push fit application
	EPDM Rubber	Square channel for box sections and square bars
	PVC, EPDM Rubber & Steel	Creates compressed seal to prevent leakages
	PVC & Steel	Reinforced with steel ribs for added strength

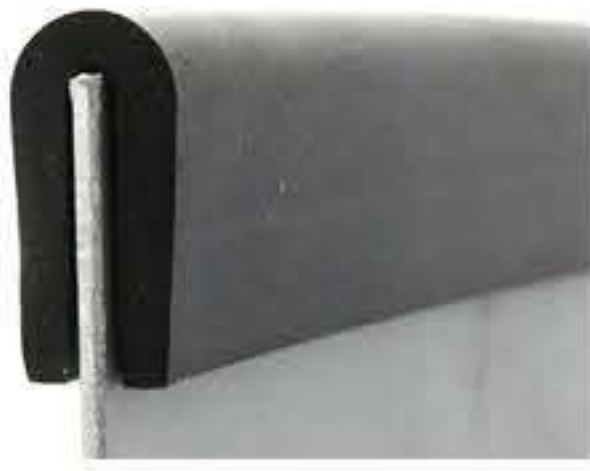

U-Channel Edging



Square Edging



Door Trim



Reinforced Edge Trim



EPDM Self Adhesive Edging



Silicone Self Adhesive Edging



Grommet Strips

U-Channel Edging

Product Code: **EDGE**

1mm - 2-4mm

- ✓ Manufactured from a solid black EPDM
- ✓ Protects exposed metal edges
- ✓ Self gripping to your object
- ✓ Versatile U-channel profile



Square Edging

Product Code: **EDGE**

3mm - 25mm

- ✓ Manufactured from a solid EPDM Rubber
- ✓ Excellent resistance and strength
- ✓ Good for protection uses
- ✓ Prevents injury



Door Trim

Product Code: **EDGE**

1-3mm - 2-4mm

- ✓ Perfect for sealing door areas and surroundings
- ✓ Manufactured from both EPDM & Steel
- ✓ Prevents leakage through door gaps
- ✓ Excellent resistance against shock



Reinforced Edging

Product Code: **EDGE**

0.8mm - 6-8mm

- ✓ Manufactured from high end PVC with Steel ribs
- ✓ Prevents exposed metal from causing injury
- ✓ Reinforced with steel for added strength
- ✓ Useful inside industry / commerce



EPDM Self Adhesive Edging

Product Code: **SAES**

6mm - 50mm

- ✓ Manufactured from a pressurized EPDM
- ✓ Prevents damage to exposed panels
- ✓ Strong pressure adhesive backing
- ✓ Versatile and resistant product



Silicone Self Adhesive Edging

Product Code: **SAES**

6mm - 50mm

- ✓ Manufactured from an expanded Silicone
- ✓ High temperature resistant up to 315°C
- ✓ Silicone pressure adhesive backing
- ✓ Insulates and protects



TPE Grommet Strip

Product Code: **EDGE**

7.6mm - 15.9mm

- ✓ Manufactured from a PA66/6 MDS filled Nylon
- ✓ Temperature resistance -40°C to 65°C
- ✓ Built in lubrication to reduce friction
- ✓ Range of useful applications



Polystyrene Grommet Strip

Product Code: **EDGE**

13mm - 6.4mm

- ✓ Great for binding and framing exposed panel edges
- ✓ Manufactured from a high impact Polystyrene
- ✓ Temperature resistant -20°C to 50°C
- ✓ Cut to fit lengths available



We hold a large variety of **Edging Strip** in stock, however, we also offer **custom sizing** where required for your specific needs.

If you require a **custom profile** give us a call on **01233 713 581**

Or visit our website www.vital-parts.co.uk/edging

Our range of **Bushes, Spacers & Washers** has been developed to cover an **array of industries and uses**, from inside the household, to during production of a product. Offering over **10 different styles of Washers**, made up of 6 **highly resistant materials**, look no further for your requirements!



Material	Properties	Washers
Nylon	Strong, reliable, lightweight	
HDPE	Durable, good level of resistance to chemicals	
Peek	Heat resistant up to 180°C, flame resistance - UL94 V-0	
TPR Rubber	Vibration dampening, provides air tight seal	
LDPE	Strong, reliable	



Spacers & Washers



Nylon Washers



Rubber Washers

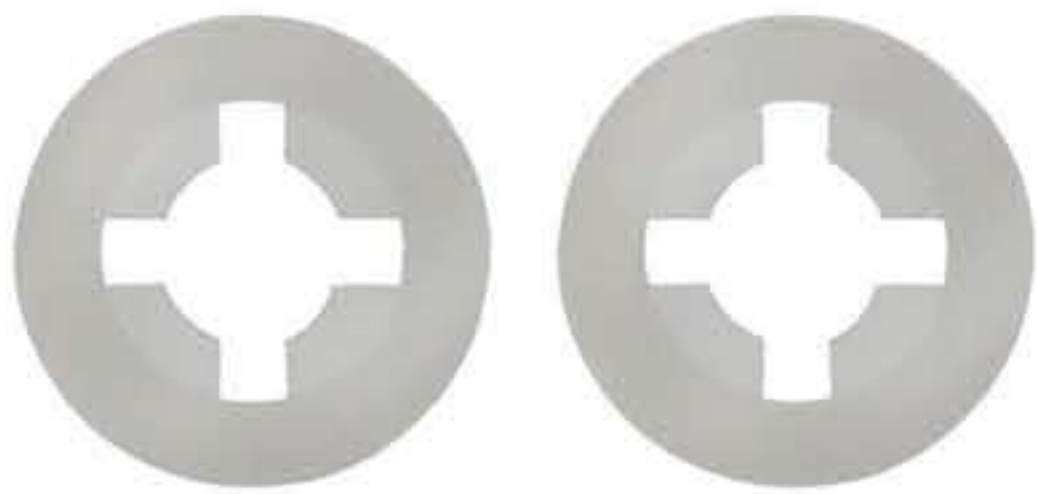

Anti-Loss Washers



Peek Washers



Finishing Washers



Headboard Washers



Saddle Washers

Bushes & Spacers

Product Code: **NYS**

3mm - 50mm

- ✓ Manufactured from high strength Nylon 6/6
- ✓ Available with or without flange
- ✓ Great for spacing uses
- ✓ Black or natural finish



Nylon Washers

Product Code: **WASH**

M2 - M39

- ✓ Seals and prevents movement in mechanisms
- ✓ Dampens vibrations between components
- ✓ Manufactured from a durable Nylon 6/6
- ✓ Available in black or natural finishes



Rubber Washers

Product Code: **WASH**

3.2mm - 21mm

- ✓ Manufactured from high quality TPR
- ✓ Dampens vibrations and noise
- ✓ Prevents ingress or spillage
- ✓ Provides an air tight seal

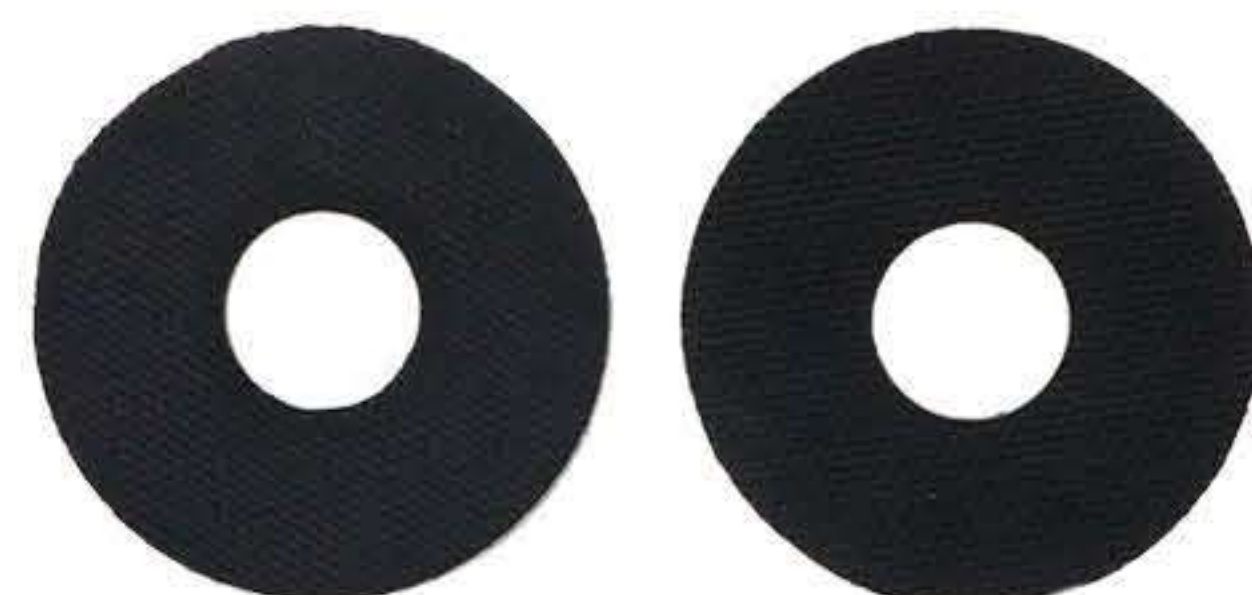

Anti-Loss Washers

Product Code: **WASH**

M2 - M16

- ✓ Manufactured from premium Nylon 6/6 & HDPE
- ✓ Anti-loss teeth to grip screwdriver
- ✓ Reduces vibrations between
- ✓ High strength product

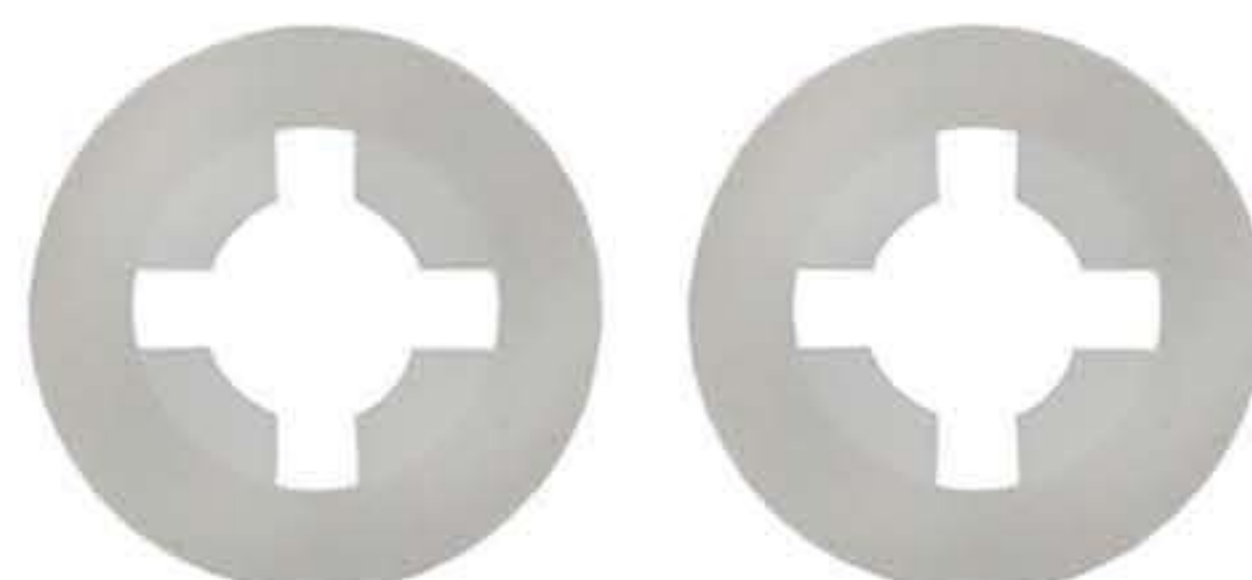

Peek Washers

Product Code: **WASH**

2.7mm - 10.5mm

- ✓ Manufactured from premium Peek sheeting
- ✓ High specification washer solution
- ✓ Temperature resistant up to 180°C
- ✓ Flame resistance: UL94 V-0



Finishing Washers

Product Code: **FWA**

M2.5 - M8

- ✓ Excellent protection and insulation properties
- ✓ Manufactured from Black / Natural Nylon 6.6
- ✓ Available in 5 different styles
- ✓ Prevent excess movement



Headboard Washers

Product Code: **WASH**

8.4mm

- ✓ Improves spacing between wall/headboard
- ✓ Manufactured from a premium LDPE
- ✓ Connect a headboard to a wall
- ✓ To fit 36mm outside diameter



Saddle Washers

Product Code: **WASH**









12-14mm - 50-60mm

- ✓ Manufactured from a quality Nylon 6/6
- ✓ Available in black or natural finishes
- ✓ Support tubular frames / objects
- ✓ Ideal for tube assembly uses



Gaskets & Seals are an essential product within industry, commonly used within **Oil, Water & Gas** related employments to **protect, cover and seal** pipe and fluid systems. Offered in **many different materials and specifications**, we supply both **custom** gaskets, and **standard** rubber seal sizes for varied uses.



Material	Resistant to...	Full Face / Insertion	
EPDM	Acids, Alkalis		
Graphite	Extreme Temperatures		
Nitrile	Oils, Gases, Petroleum Fluids		
Non Asbestos X	Natural Gases, High Temperatures		
Non Asbestos Y	Oils, Break Fluids, Cooling Fluids		
SBR	Water, Air		



Full Face EPDM
Gaskets



Full Face Graphite
Gaskets



Full Face Nitrile
Gaskets



Full Face Non Asbestos
X Gaskets

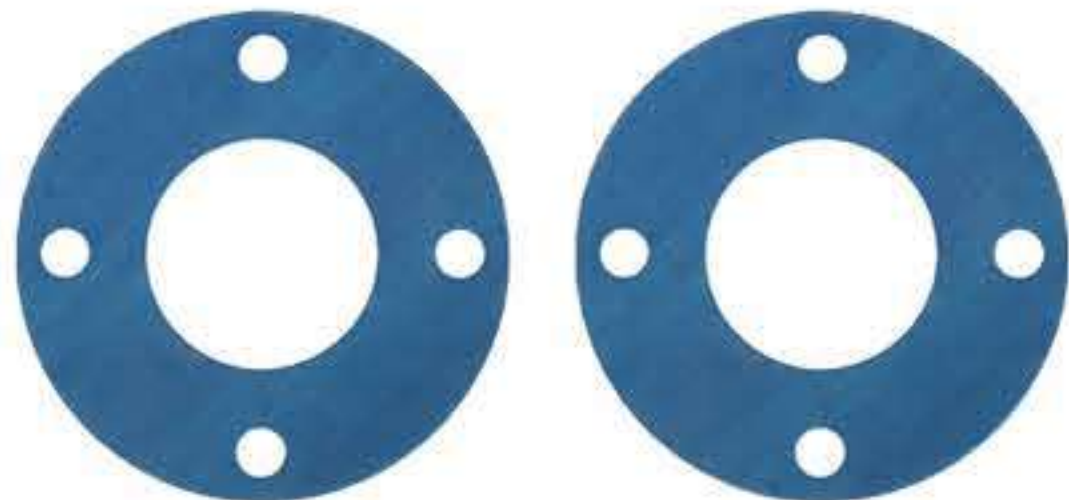

Full Face Non Asbestos
Y Gaskets



Full Face SBR
Gaskets



Insertion EPDM
Gaskets



Insertion Nitrile
Gaskets



Insertion SBR
Gaskets



Rubber Cording



Custom Cording



O-Ring Kits

Full Face EPDM Gaskets

Product Code: **EPDM**

Made to order

- ✓ High continuous working temperature (100°C)
- ✓ Excellent resistance against Acids/Alkalis
- ✓ Perfect for all kinds of hygienic uses
- ✓ Range of pressure ratings



Full Face Graphite Gaskets

Product Code: **GRAPHITE**

Made to order

- ✓ Manufactured from Reinforced Graphite
- ✓ Resistant against extreme temperatures
- ✓ BAM & DVGW approved material
- ✓ Range of pressure ratings



Full Face Nitrile Gaskets

Product Code: **NITRILE**

Made to order

- ✓ Resistant against Oils, Gases & Petroleum Fluids
- ✓ Resistant to aromatic hydrocarbons
- ✓ Good level of shore hardness
- ✓ Range of pressure ratings



Full Face Non Asbestos X Gaskets

Product Code: **NON ASBESTOS X**

Made to order

- ✓ Manufactured from ground-breaking AF400
- ✓ Good for uses with natural gases
- ✓ High peak temperature of 400°C
- ✓ Range of pressure ratings



Non Asbestos Y Gaskets

Product Code: **Non Asbestos Y**

Made to order

- ✓ Flexible for use with irregular / uneven flanges
- ✓ Recommended for steam and water systems
- ✓ Manufactured from medium-duty AF300
- ✓ Range of pressure ratings

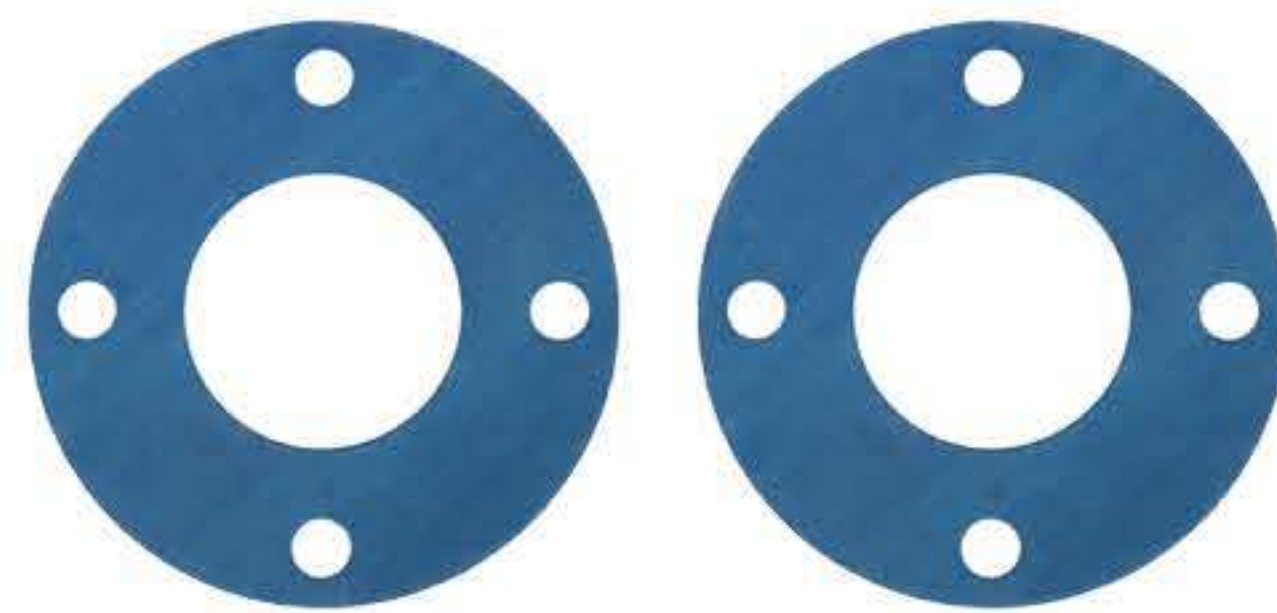

Full Face SBR Gaskets

Product Code: **SBR**

Made to order

- ✓ Manufactured from a high end SBR
- ✓ Excellent water and air resistance
- ✓ High level of tensile strength
- ✓ Range of pressure ratings

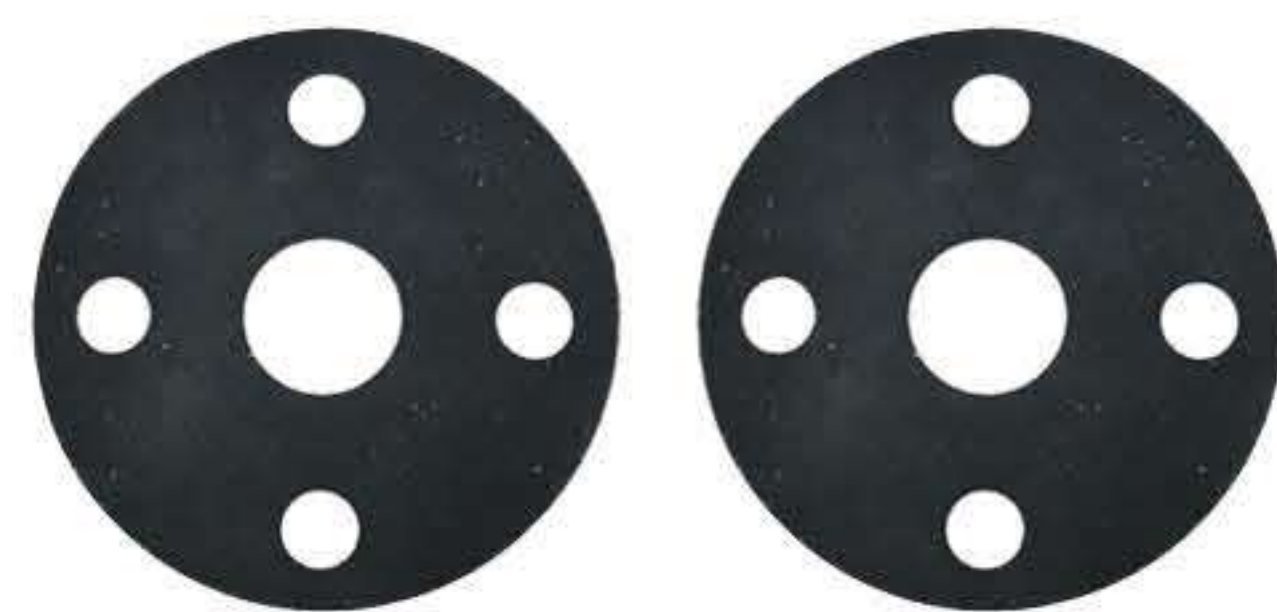

Insertion EPDM Gaskets

Product Code: **EPDM**

Made to order

- ✓ WRAS approved for use with drinking water
- ✓ Manufactured from a high quality EPDM
- ✓ Inner bolt circle type gasketing solution
- ✓ Range of pressure ratings



Insertion Nitrile Gaskets

Product Code: **NITRILE**

Made to order

- ✓ Resistant to many chemicals/solvents
- ✓ Manufactured from a high end Nitrile
- ✓ Suited for automotive industries
- ✓ Range of pressure ratings

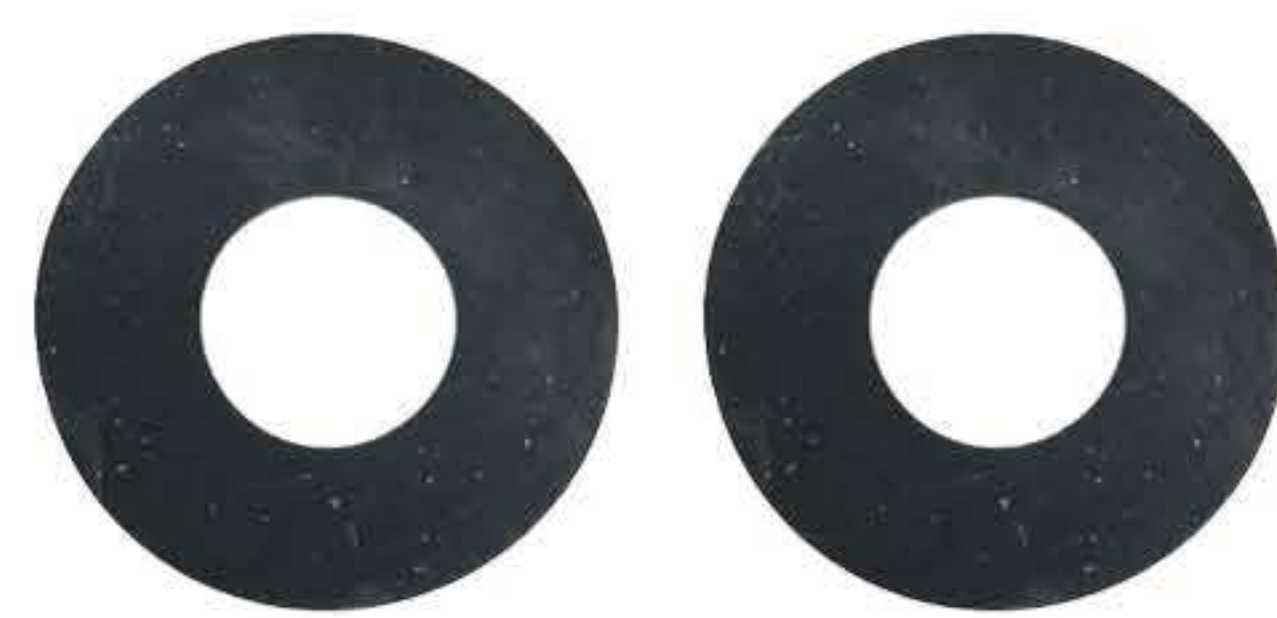

Insertion SBR Gaskets

Product Code: **SBR**

Made to order

- ✓ Manufactured from high end SBR
- ✓ Excellent water & air resistance
- ✓ High level of tensile strength
- ✓ Range of pressure ratings

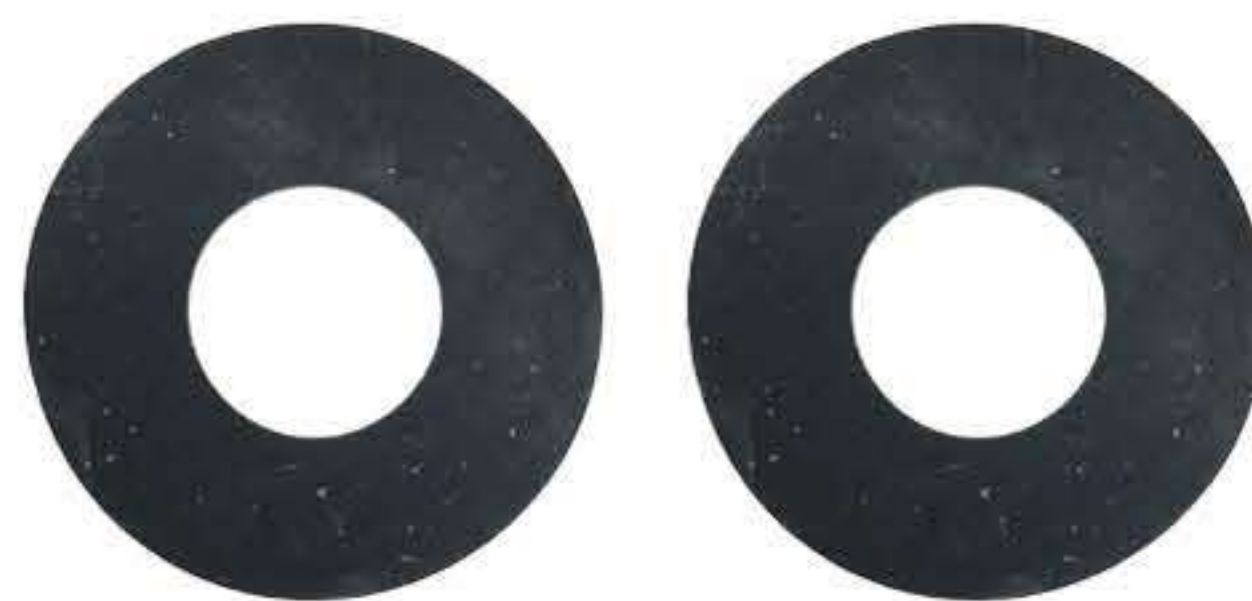

Rubber Cording

Product Code: **CORD**

3mm - 25mm

- ✓ Manufactured from a solid / sponge Neoprene
- ✓ Buffer to absorb vibrations and shock
- ✓ Compression seal to prevent ingress
- ✓ High level of general resistances



Custom Cording

Product Code: **CORD**

Made to order

- ✓ Call to enquire on 01233 713 581
- ✓ Available in a range of materials
- ✓ Made to requirements
- ✓ Custom lengths



O-Ring Kits

Product Code: **ORI**

4.1mm - 39.5mm

- ✓ Available in Nitrile or FPM from standard
- ✓ Ideal for sealing off an application
- ✓ Metric or imperial sizing stocked
- ✓ All in one Kit



Gasket Specification Form

If you require a custom size Gasket, please fill out the form below with your required type and sizing, and post it to us. Alternatively, head over to www.vital-parts.co.uk/gaskets to download an electronic version of the form and email it to sales@vital-parts.co.uk.

A member of our sales team will then get in contact with you.

Name / Company	
Email Address	
Telephone No. Gasket Type Gasket Material Specification <i>Please provide clear details around your project including any measurements and key points.</i>	
Comments <i>Please provide any extra details for your project, examples include quantity and lead time.</i>	

If you have any technical drawings for your project then please send / attach them with this form.



Our selection of **Industrial Hardware** Products includes many **high quality** solutions manufactured from materials such as Stainless Steel, Duroplast & Reinforced Nylon. Useful for **locking, positioning, clamping and operating** both basic and advanced functions, we have **carefully picked** each product for the properties that they provide.

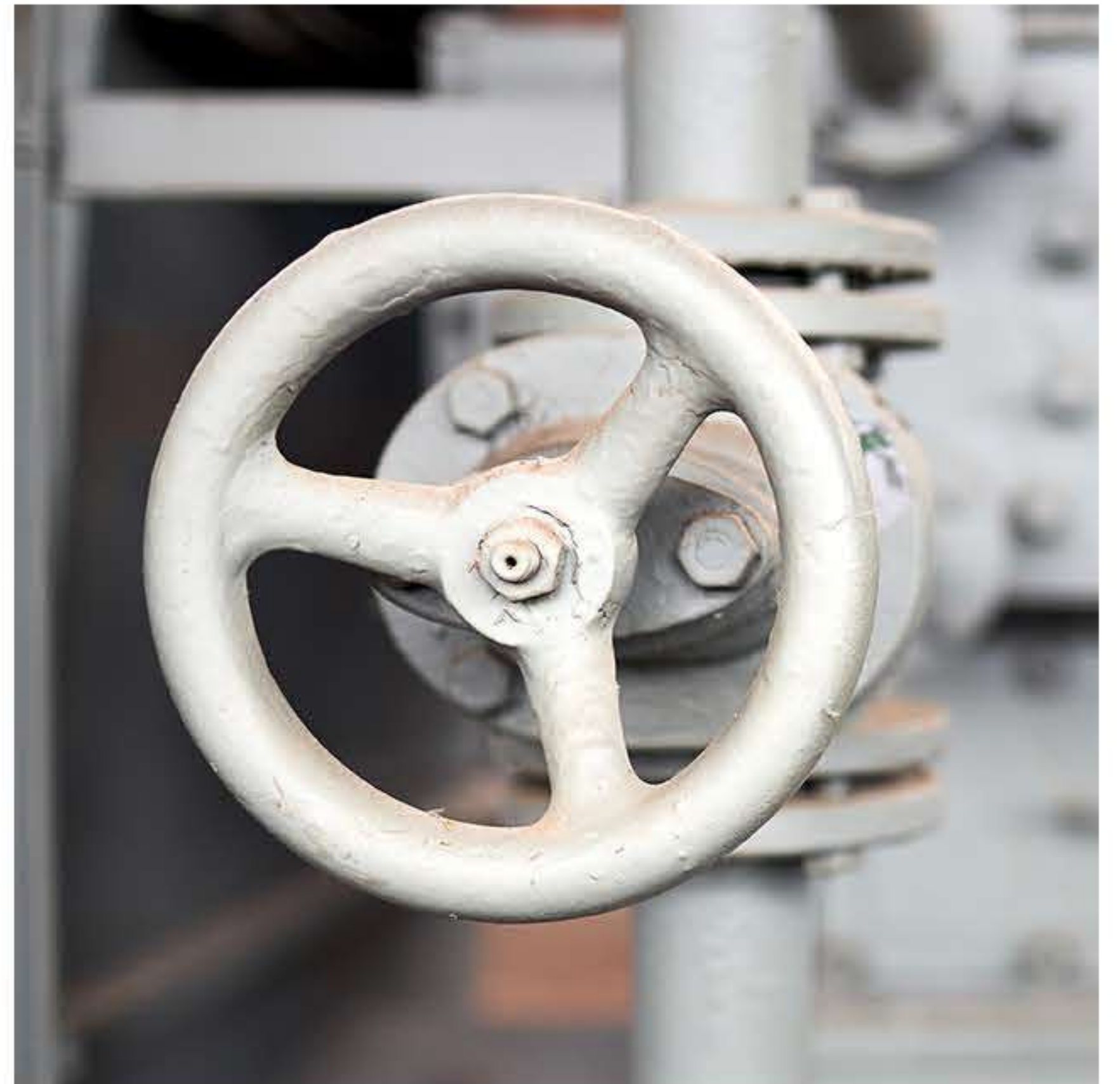
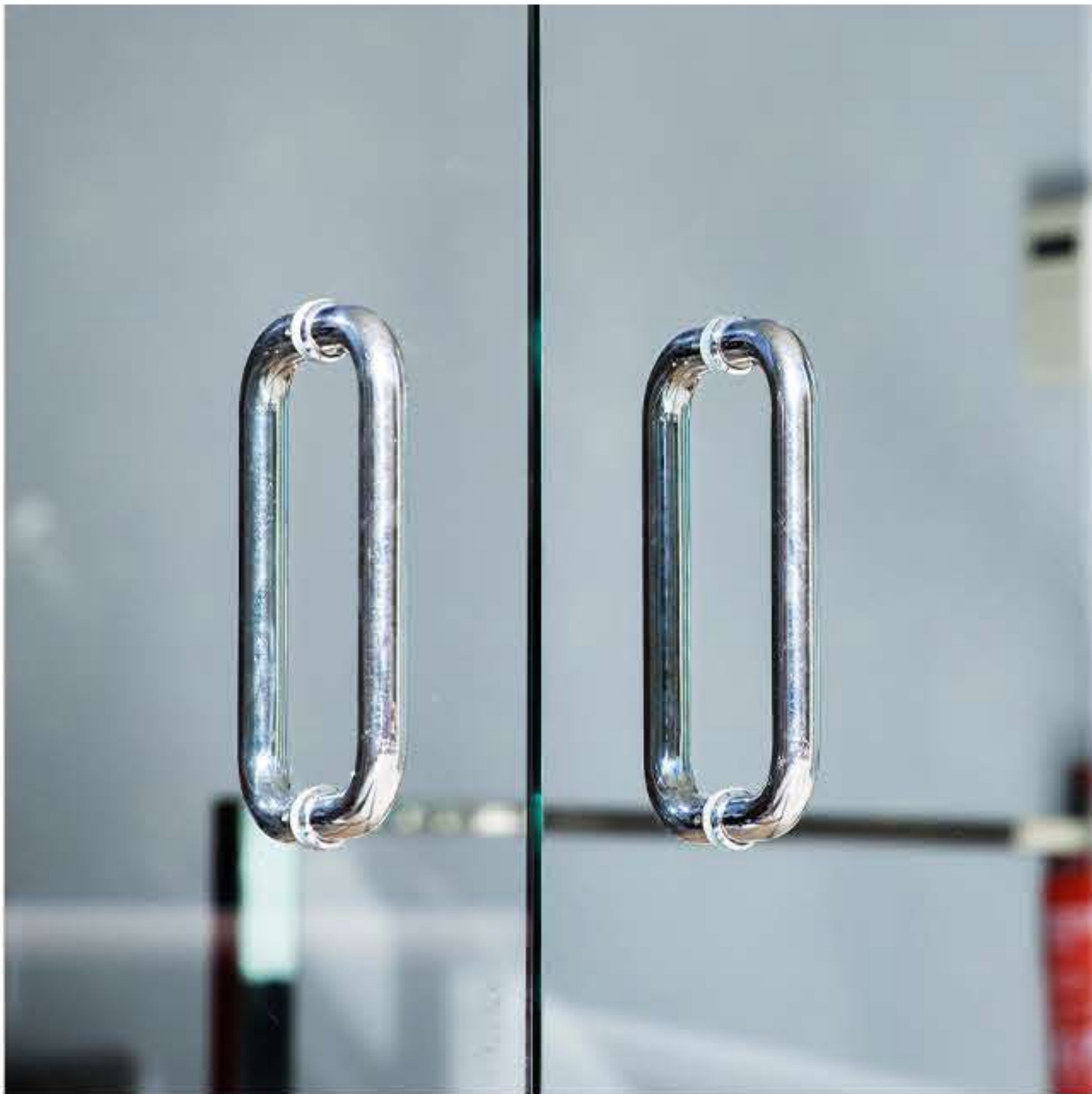

Material	Hygienic	Rust Proof	Lightweight	Cost Effective
Nylon	✓	✓	✓	✓
Steel	✗	✗	✗	✓
Duroplast	✓	✓	✗	-
Stainless Steel	✓	✓	✗	-
Aluminium	✓	✓	✓	✓

*Please note that these are only a few of the properties of each material



Bridge Handles



Index Plungers



Clamping Handles



Control Handwheels



Wing Screws & Knobs



Roof Support Feet



Unistrut End Caps

Aluminium Bridge Handles

Product Code: **HAND**

113mm - 209mm

- ✓ For use with household and industrial appliances
- ✓ Machined threads for installation from below
- ✓ Manufactured from a Matte Black Aluminium
- ✓ Provides a high end finish



Chrome Steel Bridge Handles

Product Code: **HAND**

93mm - 245mm

- ✓ Manufactured from a Polished Chrome Plated Steel
- ✓ Machined threads for installation from below
- ✓ Includes dress rings, screws and washers
- ✓ Adds to the aesthetic of an appliance



Duroplast Bridge Handles

Product Code: **HAND**

140mm - 185mm

- ✓ Manufactured from a Glossy Black Duroplast
- ✓ For installation onto industrial appliances
- ✓ Threaded inserts for fixing from below
- ✓ Resistant to chemicals, rust and heat



Nylon Bridge Handles

Product Code: **HAND**

120mm - 213mm

- ✓ Manufactured from a resistant Glass Reinforced Nylon
- ✓ Fixed from below, cover caps included
- ✓ Finished in an attractive Matte Black
- ✓ Good for basic operations



Stainless Steel Bridge Handles

Product Code: **HAND**

220mm - 325mm

- ✓ Manufactured from a polished form of Stainless Steel
- ✓ Machined threads for fixing from below
- ✓ Supplied with welded base plate
- ✓ Perfect for hygienic uses



Cam Index Plungers

Product Code: **IND**

47mm - 69mm

- ✓ Manufactured from Burnished Steel or Stainless Steel
- ✓ Spring loaded mechanism and threaded body
- ✓ Comes with locking notch from standard
- ✓ Great locking / positional element



Fixing Plate Index Plungers

Product Code: **IND**

25mm - 31mm

- ✓ Manufactured from a Zinc Plated Steel & Thermoplastic
- ✓ Available with or without a locking rest position
- ✓ Great locking / positional element
- ✓ Comes with fixing plate



Lock Position Index Plungers

Product Code: **IND**

21mm - 31mm

- ✓ Complete with impact resistant Thermoplastic Knob
- ✓ Available in Stainless Steel or Burnished Steel
- ✓ Standard 90 degree locking rest position
- ✓ Threaded body



Metal Body Index Plungers

Product Code: **IND**

18mm - 24mm

- ✓ Available in Stainless Steel / Zinc Plated Steel
- ✓ Comes with/without locking rest position
- ✓ Zinc plated die cast head from standard
- ✓ Threaded body



Retractable Index plungers

Product Code: **IND**

14mm - 17mm

- ✓ Manufactured from a high quality Aluminium
- ✓ Finished in either Chrome or Black
- ✓ Includes locking rest position
- ✓ Great for continued spaces



Ring Pull Index Plungers

Product Code: **IND**

14mm - 30mm

- ✓ Manufactured from Zinc Plated Steel & Stainless Steel
- ✓ Complete with ring pull for release
- ✓ Comes with locking nut
- ✓ Threaded body



Threaded Ball Index Plungers

Product Code: **IND**

1.5mm - 12mm

- ✓ Available in either Burnished Steel or Stainless Steel
- ✓ Threaded body with spring loaded bearing
- ✓ For locking or catching uses
- ✓ High load strength



Ergonomic Clamping Handles

Product Code: **HW**

M5 - M16

- ✓ Manufactured from a Nylon & Steel / Stainless Steel
- ✓ Comes with matching button cap
- ✓ Great for generic clamping uses
- ✓ Ergonomic design for comfort



Metal Clamping Handles

Product Code: **HW**

M4 - M16

- ✓ Manufactured from a Black Coated Die Cast Zinc Steel
- ✓ Heavy duty option for industrial clamping uses
- ✓ Allen key slot for fixing in position
- ✓ Ratchet button for rotation



Nylon Clamping Handles

Product Code: **HW**

M5 - M12

- ✓ Manufactured from a Glass Reinforced Nylon & Steel Stud
- ✓ Comes with push button ratchet for rotation
- ✓ For clamping or adjusting objects
- ✓ Allen key slot for adjustment



Stainless Steel Clamping Handles

Product Code: **HW**

M5 - M16

- ✓ Manufactured from a hygienic, non reactive Stainless Steel
- ✓ Comes with push button ratchet
- ✓ For adjusting or clamping
- ✓ Allen key adjustment slot



Stainless Control Handwheels

Product Code: **HW**

160mm - 250mm

- ✓ Manufactured from Pressed Stainless Steel
- ✓ Great for manual control operations
- ✓ Keyway slot for ease of installation
- ✓ Hygienic material properties



Steel Control Handwheels

Product Code: **HW**

125mm - 250mm

- ✓ Manufactured from Black Pressed Steel
- ✓ Resistant to many chemicals and acids
- ✓ To assist in manual control operations
- ✓ Keyway slot for ease of installation



Wing Screws

Product Code: **WING**

M5 - M10

- ✓ Manufactured from high strength, durable materials
- ✓ Offered in two ergonomic designs
- ✓ Comes with a threaded stud
- ✓ Bulk discounts available



Roof Support Feet

Product Code: **HW**

110mm - 160mm

- ✓ Capable of supporting heavy loads up to 1,350kg
- ✓ Manufactured from high quality materials
- ✓ Excellent load spreading properties
- ✓ TUV certified testing



Unistrut End Caps

Product Code: **GEN**

21mm - 42mm

- ✓ Manufactured from low density LDPE plastic
- ✓ Designed specifically for unistrut channels
- ✓ Square and rectangular sizes available
- ✓ Comes in black, white, and grey



Knobs, Grips & Handwheels are generic forms of hardware used both within household, and industrial settings. Great for **adjustment, control and finishing**, each product has varying properties which offer an **upgrade on existing solutions**, or a high quality option during manufacturing.



Style	Properties / Used For
Style 1	Used on standard round bars
Style 2	Used on round bars, ribbed for shok absorbing properties
Style 3	Good for 'turning' uses such as accelorators
Style 4	Slightly ribbed for added grip
Style 5	Finger nubs for extra grip
Style 6	Ergonomic design for strength
Style 7	Good for general uses
Style 8	Finger nubs for comfort, can be used as end stoper
Style 9	Used as replacement grips for prams and strollers
Style 10	Used on round bars as replacement handles
Style 11	Used as lever grips
Style 12	Ergonomic hand design



Standard Handwheels



Premium Handwheels



Soft Touch Handwheels



Control Handwheels



Silver Ball Knobs



Black Ball Knobs



Round Grips



Square PVC Grips



Flat PVC Grips



Wing Screws & Knobs



Push Fit Knobs

Standard Lobe Handwheels

Product Code: **HW**

45mm

- ✓ Manufactured from a high end Black Nylon
- ✓ As control knobs to adjust machinery
- ✓ Zinc plated metal thread
- ✓ Ergonomic design



Standard Scalloped Handwheels

Product Code: **HW**

30mm - 60mm

- ✓ Manufactured from Nylon and Zinc Plated Steel
- ✓ Available in both male and female thread types
- ✓ Excellent for machinery and appliances
- ✓ As handles to clamp or fasten



Standard Star Handwheels

Product Code: **HW**

40mm - 60mm

- ✓ Manufactured from a high end Thermoplastic
- ✓ Lightweight and durable product
- ✓ To control or adjust machinery
- ✓ 4 point 'star' design



Standard Triangle Handwheels

Product Code: **HW**

40mm - 60mm

- ✓ Manufactured from a high end Black Nylon
- ✓ As handles to control a basic
- ✓ Zinc Plated Steel thread
- ✓ Male / Female available



Premium Star Handwheels

Product Code: **HW**

32mm - 80mm

- ✓ Manufactured from a high quality Phenolic Plastic
- ✓ As handles to clamp or fasten heavy machinery
- ✓ Plated Male, Female & Through thread types
- ✓ Ergonomic 4 point design



Premium Scalloped Handwheels

Product Code: **HW**

32mm - 60mm

- ✓ As handwheels to adjust appliances / machinery
- ✓ Manufactured from a glossy phenolic plastic
- ✓ Excellent for adjusting or clamping
- ✓ Plated Steel insert/thread



Soft Touch Lobe Style

Product Code: **HW**

28mm - 60mm

- ✓ Manufactured from a Matte Black Polypropylene
- ✓ Replacements to enhance grip and comfort
- ✓ Soft touch Elastomer coating
- ✓ Best in class for grip



Handwheels For Machinery

Product Code: **HW**

125mm - 250mm

- ✓ Manufactured for industrial / professional uses
- ✓ Designed for operational functions
- ✓ Keywayed and plain bore options
- ✓ Variety of heavy duty materials



Aluminium Ball Knobs

Product Code: **HK**

16mm - 44mm

- ✓ Manufactured from DIN 319 Aluminium Alloy
- ✓ To act as a handle or grip knob
- ✓ Threaded / Knock In styles
- ✓ Provides a high end finish



Stainless Steel Hand Wheels

Product Code: **HK**

16mm - 44mm

- ✓ Manufactured from a premium Stainless Steel
- ✓ To finish off a piece of furniture
- ✓ Highly polished 'chrome' finish
- ✓ Threaded / Knock In styles



Thermoplastic Ball Knobs

Product Code: **HK**

15mm - 50mm

- ✓ Manufactured from a quality Thermoplastic
- ✓ Finished in matte black from standard
- ✓ Threaded / Knock In styles
- ✓ Brass or standard thread



Duroplast Ball Knobs

Product Code: **HK**

16mm - 51mm

- ✓ Manufactured from a high end Duroplast
- ✓ Glossy black finish from standard
- ✓ To add aesthetics to an object
- ✓ Brass and standard styles



Flat PVC Sleeves

Product Code: **RCAP**

3mm - 25.4mm

- ✓ To enhance the comfort properties of a lever
- ✓ Manufactured from a high quality PVC / Vinyl
- ✓ Comfortable slip on grip solution
- ✓ High gloss finish



Square PVC Sleeves

Product Code: **SCAP**

Made to order

- ✓ Produced from a quality Dip Moulded PVC
- ✓ To cover a square handle or lever
- ✓ Comfortable PVC Grip Solution
- ✓ Glossy finish from standard



Round Grips

Product Code: **GRIP**

Sizes depend on style

- ✓ Manufactured from a dip moulded Vinyl / PVC
- ✓ Perfect for adding comfort to a metal bar
- ✓ Available in 12 different styles
- ✓ Push fits onto most objects



Wing Knobs

Product Code: **WING**

M5 - M10

- ✓ Manufactured from high strength, durable materials
- ✓ Offered in two ergonomic designs
- ✓ Comes with a threaded stud
- ✓ Bulk discounts available



Knurled Push Fit Knobs

Product Code: **HW**

M3 - M8

- ✓ Made from a high strength Acetal Thermoplastic
- ✓ For installation onto a socket head cap screw
- ✓ Three styles available (Knurled, Rosette, Tee)
- ✓ Other colours upon request



Rosette Push Fit Knobs

Product Code: **HW**

M6 - M10

- ✓ Made from a high strength Acetal Thermoplastic
- ✓ For installation onto a socket head cap screw
- ✓ Three styles available (Knurled, Rosette, Tee)
- ✓ Other colours upon request



Tee Push Fit Knobs

Product Code: **HW**

M5 - M10

- ✓ Made from a high strength Acetal Thermoplastic
- ✓ For installation onto a socket head cap screw
- ✓ Three styles available (Knurled, Rosette, Tee)
- ✓ Other colours upon request



Pipe & Flange Protection is an essential process within many industries, especially Oil & Gas where large pipes and flanges may regularly be transported to external sites. Offering **best in class properties**, each product has been carefully designed to offer excellent coverage to meet your requirements.

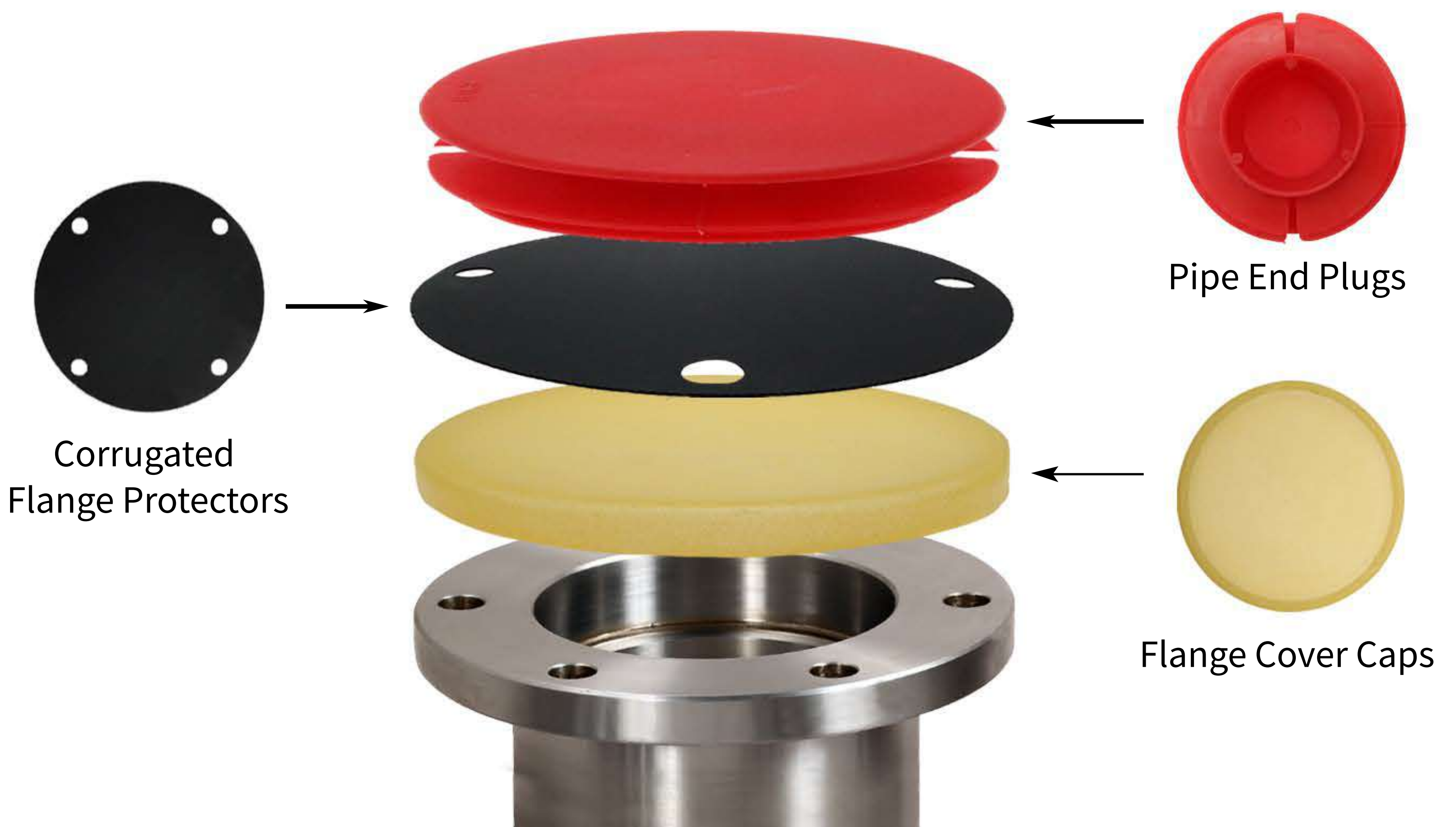
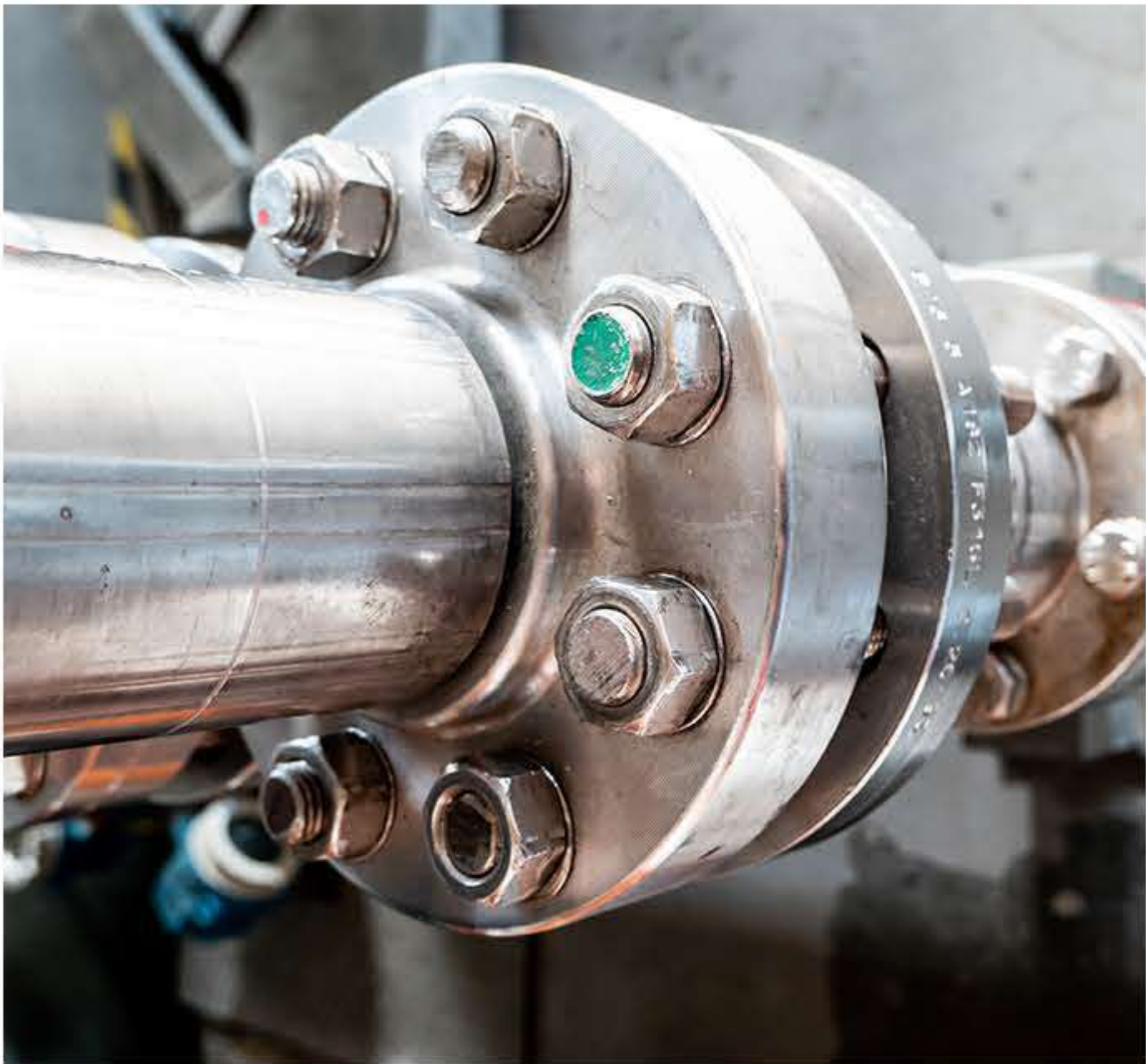



Stick on Flange
Disc

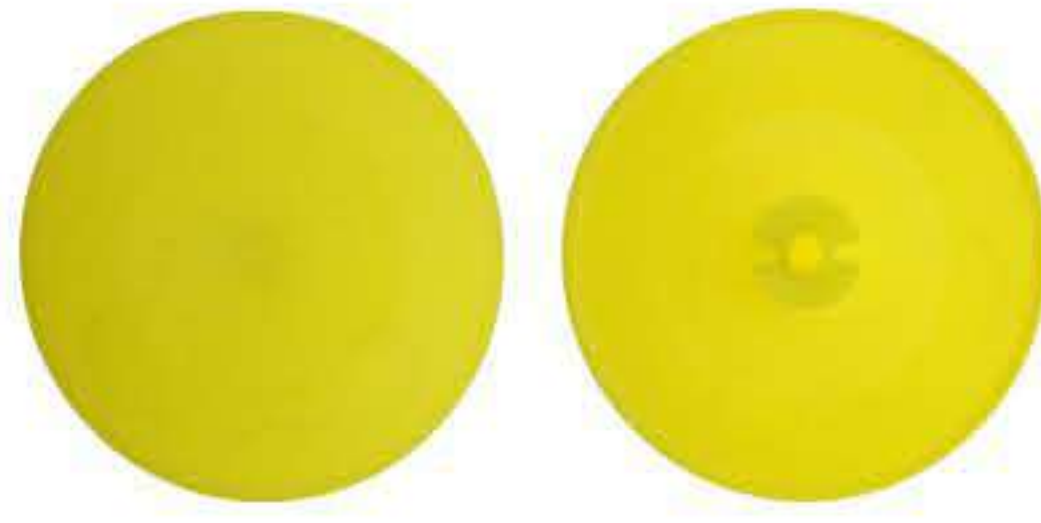

Full Face Flange
Protectors



Flange Stud Covers



Corrugated Flange
Protectors



Flange Cover Caps



Pipe Caps



Pipe End Plugs

Stick On Flange Discs

Product Code: **FD**

36mm - 857.2mm

- ✓ Resistant against Acids, Alkalis and Heat
- ✓ Manufactured from Neoprene Rubber
- ✓ Ideal for temporary flange protection
- ✓ Low-tack adhesive from standard



Full Face Flange Protectors

Product Code: **FFP**

86mm - 450mm

- ✓ Prevents damage during transport/storage
- ✓ Manufactured from a highly durable LDPE
- ✓ Flexible ribs for tight fitting to the bore
- ✓ Covers the full face of the flange



Flange Stud Covers

Product Code: **FLC**

1" - 12"

- ✓ Manufactured from a high quality LDPE
- ✓ Protects during storage or transport
- ✓ Push fits into defined bore holes
- ✓ Prevents excess wear/damage



Corrugated Flange Protectors

Product Code: **FPD**

75mm - 1168.4mm

- ✓ Made from a high quality Polycor Plastic
- ✓ Resistant, durable & long lasting
- ✓ Prevents damage during transit
- ✓ Protect the full face of a flange

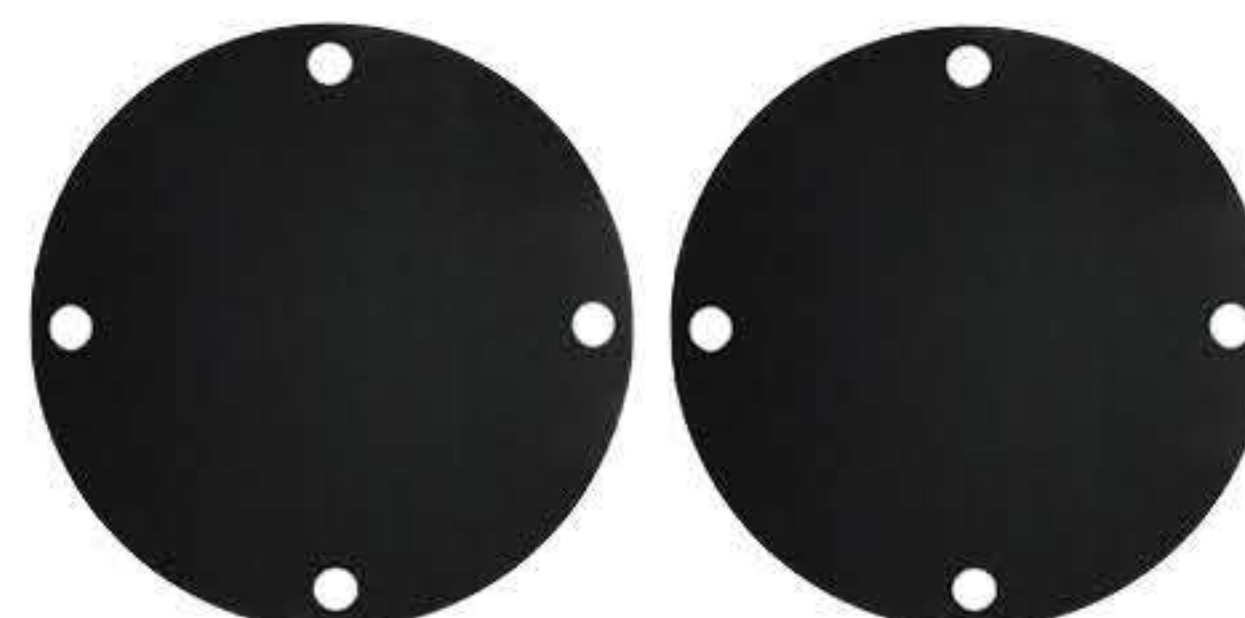

Flange Cover Caps

Product Code: **FCC**

75mm - 1041.4mm

- ✓ Manufactured from a flexible Polyethylene
- ✓ For covering/protection during storage
- ✓ Easily covers the full face of the flange
- ✓ Impact and moisture resistant



Pipe Caps

Product Code: **PIP**

37.7mm - 1642mm

- ✓ Manufactured from a resistant Polyethylene
- ✓ Easily fits over the face and lip of a pipe
- ✓ Slight flexibility for ease of installation
- ✓ Ribbed for a tight and secure fitting



Pipe End Plugs

Product Code: **RPP**

10mm - 114.3mm

- ✓ Manufactured using a hard wearing LDPE
- ✓ Multiple ribs to promote a secure fit
- ✓ Plugs in the end of a tube or pipe
- ✓ Ideal pipe protection solution



Priority Free Samples



Priority Free Delivery



Bulk Trade Pricing

Enjoy all these benefits when you set up a **Business Account** with us!

Our selection of **Scaffold Protection** products have been carefully chosen to adhere to **Health & Safety requirements** on-site. Each solution has been carefully designed, using **high visibility colours** and **heavy duty materials** to offer a well rounded solution.



Manufactured to meet strict **EN74/BS1139** Industry Standards
Adheres to **BS EN 12811-1** European Standards
Offered in bright and high visibility colours



Rebar Safety Caps



Scaffold Base Plates



Scaffold End Caps



Scaffold Inserts



Scaffold Stud Bolt
Caps

Rebar Safety Caps

Product Code: **SAFE**

8mm - 50mm

- ✓ Manufactured from a premium LDPE
- ✓ Covers exposed poles/rebar
- ✓ Temperature & UV Resistant
- ✓ Industry standard sizing



Scaffold Base Plates

Product Code: **SCAF**

220mm

- ✓ Manufactured from a high quality HDPE
- ✓ Prevents damage to the floor
- ✓ Supports the base of scaffold
- ✓ Heavy duty design



Scaffold End Caps

Product Code: **SCAF**

48.3mm

- ✓ Manufactured from a premium LDPE
- ✓ Meets health and safety guidelines
- ✓ Prevents damage and ingress
- ✓ Industry standard sizing



Scaffold Inserts

Product Code: **RO**

47.7mm - 48.4mm

- ✓ Designed to fit perfectly into Scaffold Poles
- ✓ Adheres to health and safety regulations
- ✓ Protects from weathering/damage
- ✓ Quick and easy to fit product



Scaffold Stud Bolt Caps

Product Code: **SCAF**

13mm

- ✓ Manufactured using a premium LDPE
- ✓ Meets all Health and Safety guidelines
- ✓ Fits over exposed scaffold studs
- ✓ Durable re-usable product

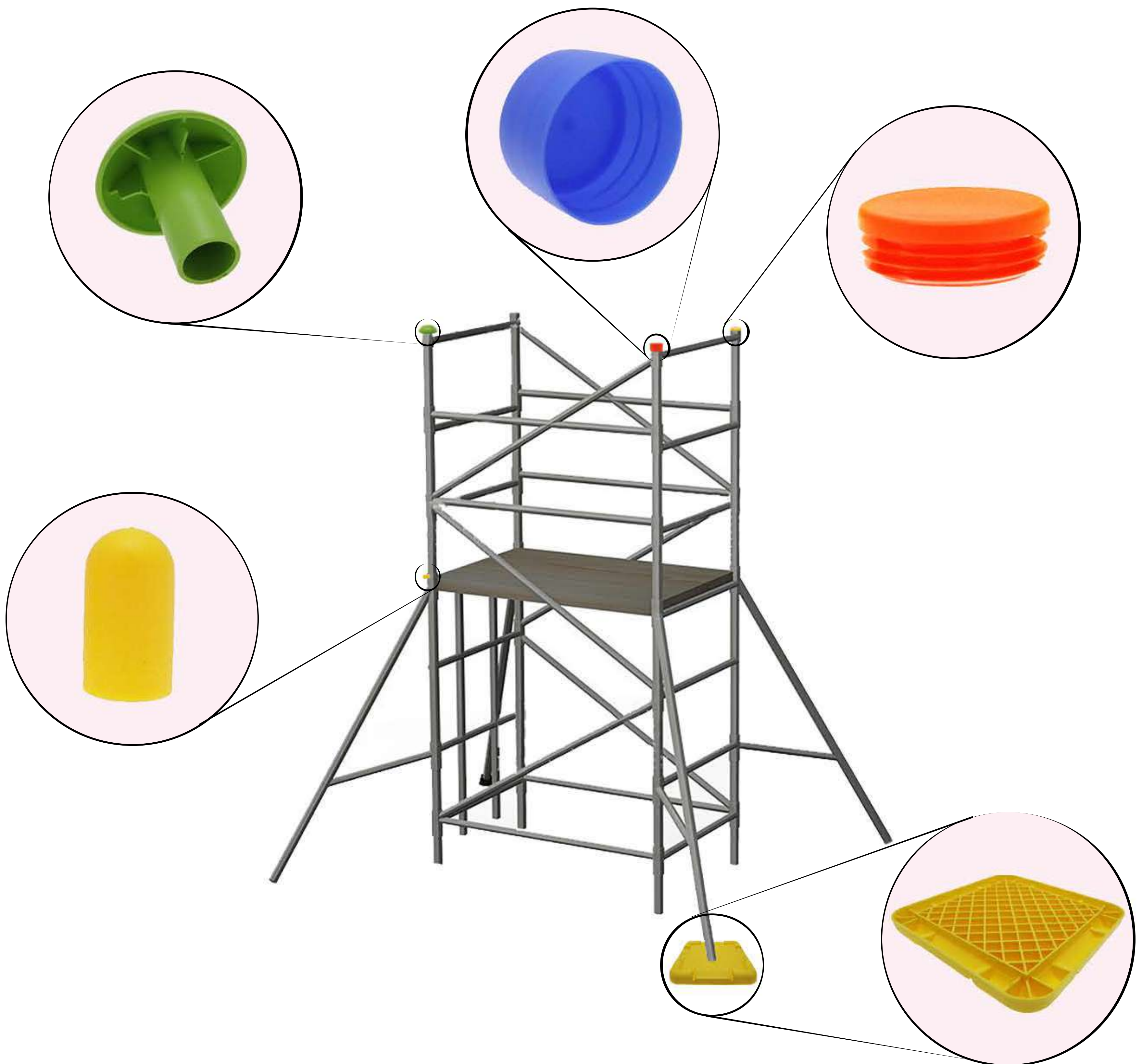

As a manufacturer of these **Anti Vibration Solutions**, we are able to provide a number of other premium materials across both Mount and Buffer styles. These include **High Temperature Rubber** and **Stainless Steel**, which are available upon request.



Product	Properties / Used For
Buffers	Designed to reduce excess vibrations within moving elements or components. Compatible with both shear and compression forces.
Mounts	Used within combustion engines, industrial machinery, transit cases, generators, and many more applications. Designed to be screwed into a threaded hole.
Feet	Widely used within industrial settings, where they provide an ideal level of shock absorbing and vibration dampening properties at a low cost.
Washers	Cut into ring shaped pieces which can then be used to dampen vibrations between mechanical components, or to provide a high level compression seal.



Flat Female Vibration Buffers



Flat Male Vibration Buffers



Tapered Vibration Buffers



Conical Vibration Buffers



Male - Male Mounts



Female - Female Mounts



Male - Female Mounts

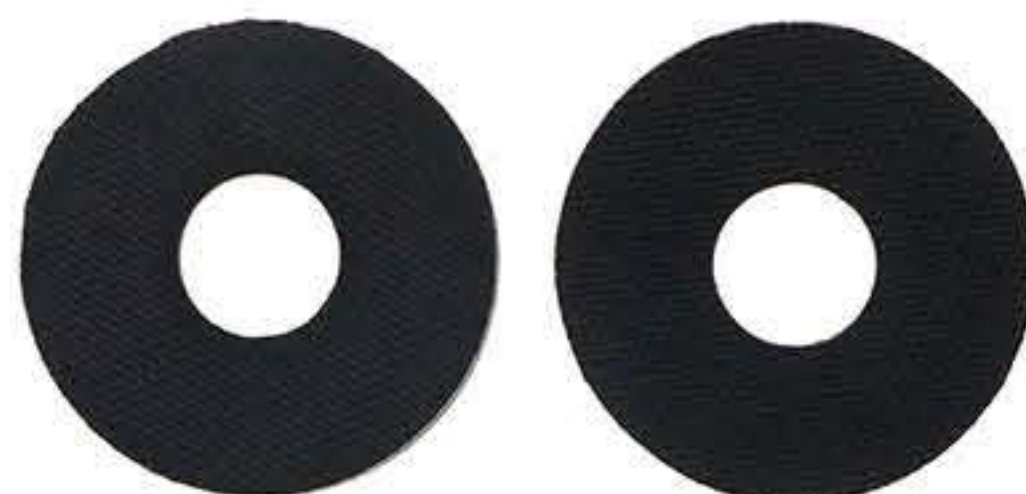

Rubber Washers



Octagonal Rubber Feet



Straight Rubber Feet



Tapered Rubber Feet



Screw On Rubber Feet



Turret Mounts



Hanger Mounts

Flat Female Vibration Buffers

Product Code: **AVM**

M46- M16

- ✓ Manufactured from high strength materials
- ✓ Custom materials available upon request
- ✓ Ideal for any shock absorbing roles
- ✓ Level of versatility



Flat Male Vibration Buffers

Product Code: **AVM**

M3 - M16

- ✓ Manufactured from corrosion resistant materials
- ✓ Available in a number of stud combinations
- ✓ Resistant to high temperatures
- ✓ Great for vibration and shock



Tapered Vibration Buffers

Product Code: **AVM**

3.8mm - 11.9mm

- ✓ Used for both sheer and compression forces
- ✓ Manufactured from a Zinc Plated Steel
- ✓ Male threaded stud from standard
- ✓ Designed with a tapered base



Conical Vibration Buffers

Product Code: **AVM**

0.89mm - 53.47mm

- ✓ Manufactured from a Zinc Plated Steel
- ✓ Easily screwed onto a female thread
- ✓ Commonly used with machinery
- ✓ Prevents excess vibration



Male - Male Mounts

Product Code: **AVM**

M3 - M20

- ✓ Made from corrosion resistant Zinc Plated Steel
- ✓ Available in a number of stud combinations
- ✓ Feature a male stud on either side
- ✓ High temperature resistant



Female - Female Mounts

Product Code: **AVM**

M4 - M20

- ✓ Used with both compression and shear forces
- ✓ Feature a double sided female thread
- ✓ Reduce excessive vibration and shock
- ✓ Common in industrial machinery



Male - Female Mounts

Product Code: **AVM**

M4 - M16

- ✓ Install onto both male and female threads
- ✓ Custom materials available upon request
- ✓ Paired with a natural rubber
- ✓ Great for vibration and shock



Rubber Washers

Product Code: **WASH**

3mm - 37mm

- ✓ Manufactured from quality TPR rubber
- ✓ Dampens vibrations and noise
- ✓ Provides an air tight seal
- ✓ Multipurpose product



Octagonal Rubber Feet

Product Code: **ADJ**

M6 - M10

- ✓ Ideal for adding height to an application
- ✓ Eight sided base for excellent stability
- ✓ Manufactured from a Nitrile Rubber
- ✓ Durable and resistant



Straight Rubber Feet

Product Code: **ADJ**

M6 - M12

- ✓ Manufactured from a premium rubber
- ✓ Designed to dampen vibrations
- ✓ Excellent anti slip properties
- ✓ Height adjustable thread



Tapered Rubber Feet

Product Code: **ADJ**

M6 - M12

- ✓ Features either a steel or stainless steel thread
- ✓ Designed with excellent gripping properties
- ✓ Used to stabilize and add height
- ✓ For use with a range of surfaces



Screw On Rubber Feet

Product Code: **SCOF**

13mm - 35mm

- ✓ Made from either a natural rubber or TPR
- ✓ Countersunk hidden screw head area
- ✓ Ideal for use with wooden furniture
- ✓ Great durability and strength



Turret Mounts

Product Code: **AVM**

M8 - M12

- ✓ Manufactured from Zinc Plated Steel & Rubber
- ✓ Compatible with multiple applications
- ✓ Rubber design prevents corrosion
- ✓ Optimal vibration reduction



Hanger Mounts

Product Code: **AVM**

M6 - M10

- ✓ Manufactured from Zinc Plated Steel & Rubber
- ✓ Three different shore hardness options
- ✓ For ceiling mounted applications
- ✓ Threaded for a secure mount



Our Quick Step Guide to Anti-Vibration Mounts

1. Determine the total weight of the equipment and number of mountings required.
2. Calculate the weight on each mounting (Consider that weight may not be evenly distributed).
3. Determine the running speed (or forcing frequency) of the equipment.
4. Determine the static deflection of the mounting from the chart below (Generally 70% Isolation is acceptable for most applications)

Running Speed (RPM)	% Vertical Isolation Required		
	70%	80%	90%
1000	4.0mm	5.4mm	10.0mm
1500	1.8mm	2.5mm	4.5mm
3000	0.5m	0.7mm	1.2mm

5. Based on the load per mounting, select a suitable mounting type to give the required static deflection, considering the specific application requirements, such as whether the equipment is Mobile or Static.
6. Ensure that all connections & services to the equipment, such as exhausts, pipework and ducting are flexible in order to allow the equipment to move freely.



Finding Us

Based in Maidstone, Kent we keep over 1,000,000 components in stock ready for next day delivery at all times, ensuring we have the product you require, when you need it.

 www.vital-parts.co.uk

 01233 713 581

