



Temporary construction signs with lasting quality

Construction
SIGNS
Catalogue



Call: 01737 774 077

Email: sales@stocksigns.co.uk

Stocksigns Construction

Providers of temporary signage for the construction industry



All our signs are manufactured here in the UK



Dedicated Account Manager



Next day delivery on orders before 1 pm



Free logo print on every sign

HOW TO ORDER

Call - 01737 774 077

Email - sales@stocksigns.co.uk

or order online - www.stocksigns.co.uk

Delivery will be charged at £9.75 per order

Payment

- Choose your payment method: Credit Card - We accept Mastercard & Visa.
- Cheques should be made payable to Stocksigns.
- We will be happy to open a credit account for you (subject to standard credit checks).
All such sales are payable no later than 30 days from invoice date.
- All prices are exclusive of Value Added Tax
- Phone, post or e-mail (sales@stocksigns.co.uk) your order.

Returns

- If for any reason you have to return products to us, please contact our Customer Services Team on 01737 774 741

See Page 62 for Terms & Conditions

CORREX SIGNS

Most of our signs are available in a choice of lightweight 4mm and a more durable 10mm thick corrugated PVC material which are ideal for temporary use.

We can also supply signs in the following materials

- Foamex - 2mm or 5mm
- Aluminium Composite - 3mm
- Rigid Plastic - 1mm or 3mm
- Self-adhesive Vinyl
- Non - PVC Bubble Board - 3mm

Our signs are also now available on NON - PVC BUBBLE BOARD

The Enviro Signs Bubble board is sturdy and rigid with a smooth print finish and excellent display appearance.

Being 100% recyclable the bubble board is 3mm thick and offers a hard-wearing temporary signage alternative to conventional plastic and foam boards.



More information on Page 62

Legislation and guidance	4
Artwork Guide	5
Main Site Board *	6
Sign Packs - Starter pack	7
Sign Packs - Main Sign pack *	8-9
Sign Packs - Health & Safety pack *	10
Sign Packs - Traffic Management pack *	11
Sign Packs - Waste Management pack *	12
Sign Packs - Pedestrian Route pack *	13
Scaffolding Signs *	14-17
Site Safety Signs	18-21
Site Access Signs	22-27
Site Hazard Signs	28-29
Site Security Signs	30-31
Parking Signs	32-33
Traffic Management Signs *	34-37
Waste Management Signs *	38-41
Hard Hat Labels	41
Fire Safety Signs	42-44
First Aid Signs	45
Site Information Signs	46-51
General Notices	52-53
Safety Noticeboards	54-57
Hoardings	58
Stackboards	59
Banners	60
Corporate Branded Signs	61
Extra Information	62



ARE YOUR SIGNS COMPLIANT?

Legislation and compliance has continued to play an increasingly important role in the concerns of signage consumers.

Whether you are health and safety manager, building contractor or the construction site manager – everyone has a duty of care to ensure pertinent and correct signage is put in place where legally required.

This British Standard was replaced in 2011 by BS EN ISO 7010, with this new standard effectively developed to provide a consistency in design across all EU countries.

All of the signs in the Stocksigns Construction catalogue comply with the current standard in place. By publicising this, it is our intention to help all customers understand and fulfil their health and safety obligations.

ARE YOU A MEMBER OF THE CONSIDERATE CONSTRUCTORS SCHEME?

We can print the CCS logo on your branded signs **FREE OF CHARGE**.

If you are part of the CCS scheme, including the logo is good practice and advertises your commitment to being as considerate to the local community and its surroundings as possible.

By promoting your membership:

- You will show that your company is keen to co-operate with the general public, which may help a smoother delivery of your project.
- It will illustrate you are managing your site to the highest standards of good housekeeping.
- As a considerate construction company, the logo shows your commitment to the environment in terms of waste management and noise levels.
- The logo also serves to demonstrate how seriously you take your responsibilities to safety, for your workers, visitors and the general public.



ACCEPTED FILE FORMATS

When supplying artwork for print it is important to check that files are suitable **before** submitting them. If unsure, please contact us on 01737 774 741

The following guidelines should assist with preparing acceptable files for print.

File formats

- jpg/jpeg, bmp or tiff (bitmap images)
- ai, eps or pdf (vector images)

Bitmap images

- Colours must be CMYK colour mode
- Images must be saved to maximum quality, with a resolution of at least 200dpi for small sized print, or at least 300dpi for large format print.
- Try to avoid compressing the image as this will reduce the quality.
- Minimum logo size for signs up to 400mm wide is 50mm high at 150dpi. For signs larger than 400mm wide, logo size must be no less than 100mm high at 150dpi.

Vector images

- Colours must be CMYK colour mode.
- Images must be saved as an ai, eps or pdf file.
- All text must be converted to curves, outlines or paths.

Very often these artwork formats are available from your Marketing team, just simply give them this guide and we can work together to provide you with high quality output every time.

If you require our Graphics team to rework your logo, this will be charged at a flat rate of £20

Same day bespoke artwork is charged at a flat rate of £40

Low-res jpg file format



High quality vector image



“Beard have worked closely with Stocksigns for 6 years and cannot fault the friendly service and speed of delivery. No matter how obscure the request if it is sign related they have never let us down.”

Darren Kent
(Services Division Team Leader)
Beard Construction

Our Main Site Boards are available in either Portrait or Landscape



YOUR LOGO HERE
SITE NAME

All drivers and visitors please report to site agents office

Safety helmets must be worn

High visibility jackets must be worn

Protective footwear must be worn

Parents Building sites are dangerous Please keep your children away

Any person caught pilfering or causing damage on this development may be liable for prosecution

First aid First aid equipment kept in site office

We apologise for any inconvenience caused during development works

Site Manager

Emergency Contact

EE10213 1220 x 2440mm £142.00

SITE NAME **YOUR LOGO HERE**

All drivers and visitors please report to site agents office

Safety helmets must be worn

High visibility jackets must be worn

Protective footwear must be worn

Parents Building sites are dangerous Please keep your children away

Any person caught pilfering or causing damage on this development may be liable for prosecution

First aid First aid equipment kept in site office

We apologise for any inconvenience caused during development works

Site Manager

Emergency Contact

EE10214 2440 x 1220mm £142.00

To offer an extra helping hand, Stocksigns, have created a selection of Sign Packs. The packs are a quick, easy and cost-effective way of ensuring you have all the signs needed for a safe construction site.

Whether you are in need of a basic starter pack, traffic management signs, or a full suite of health and safety signs, our packs have been carefully selected to suit any construction site and also help meet safety regulations.

Starter Pack

5 essential signs to help make your site safe and compliant.

Pack code - EE10000



from *
ONLY £55

YOUR LOGO HERE

YOUR LOGO HERE

600 x 400mm

YOUR LOGO HERE

Assembly point

600 x 400mm

YOUR LOGO HERE

No unauthorised access

400 x 300mm

YOUR LOGO HERE

Danger Construction site

Keep out

400 x 300mm

YOUR LOGO HERE

SITE SAFETY

All drivers and visitors please report to site agents office

Protective equipment must be worn by all personnel on this site

Parents Building sites are dangerous Please keep your children away

Any person caught pilfering or causing damage on this development may be liable for prosecution

First aid First aid equipment kept in site office

We apologise for any inconvenience caused during development works

600 x 800mm

5 signs starter pack

Correx	4 mm	10 mm
Prices	£55.00	£65.00

NEW
PRODUCT

Main Sign Pack

All the vital signs needed for a safe construction site.

Pack code - EE10216 38 Signs £700.00

YOUR LOGO HERE
SITE NAME

All drivers and visitors please report to site agents office

 Safety helmets must be worn

 High visibility jackets must be worn

 Protective footwear must be worn

 Parents Building sites are dangerous Please keep your children away

 Any person caught pilfering or causing damage on this development may be liable for prosecution

 First aid First aid equipment kept in site office

We apologise for any inconvenience caused during development works

Site Manager

Emergency Contact

1220 x 2440mm Qty 1

YOUR LOGO HERE

 **Danger**
Construction site

 **Keep out**

800 x 600mm Qty 5

YOUR LOGO HERE

 **Safety equipment must be worn**

800 x 600mm Qty 2

YOUR LOGO HERE

 **Task specific PPE must be worn when required**

800 x 600mm Qty 2

YOUR LOGO HERE

 **Construction site**

600 x 400mm Qty 2

YOUR LOGO HERE

Reserved parking

 **Main contractor staff**

600 x 400mm Qty 1

YOUR LOGO HERE

 **Site speed limit**

600 x 400mm Qty 3

YOUR LOGO HERE

 **Pedestrian access**

600 x 400mm Qty 5

YOUR LOGO HERE

Reserved parking

 **For site management**

400 x 300mm Qty 1

YOUR LOGO HERE

 **Car parking area**

400 x 300mm Qty 1

YOUR LOGO HERE

 **Reserved parking**

400 x 300mm Qty 1

YOUR LOGO HERE

Canteen

400 x 300mm Qty 1

YOUR LOGO HERE

Site office

400 x 300mm Qty 1

YOUR LOGO HERE

Drying room

400 x 300mm Qty 1

YOUR LOGO HERE

Site entrance

600 x 400mm Qty 2

YOUR LOGO HERE

 **Assembly point**

600 x 400mm Qty 1

YOUR LOGO HERE

 **Highly flammable**

 **No smoking**

 **No naked lights**

600 x 400mm Qty 1

YOUR LOGO HERE

Toilet

400 x 300mm Qty 1

YOUR LOGO HERE

 **No smoking**

400 x 300mm Qty 4

YOUR LOGO HERE

Keep this facility clean It is for your benefit

400 x 300mm Qty 2

Health & Safety Pack

A selection of hazard, prohibition, mandatory and information signs for a safe site.

Pack code - EE10217 22 Signs £265.00



400 x 300mm Qty 1



400 x 300mm Qty 1



400 x 300mm Qty 1



400 x 300mm Qty 1



400 x 300mm Qty 4



400 x 300mm Qty 2



600 x 400mm Qty 3



600 x 400mm Qty 1



600 x 400mm Qty 2



600 x 400mm Qty 2



600 x 400mm Qty 1



600 x 400mm Qty 2



600 x 400mm Qty 1

NEW
PRODUCT

Traffic Management Pack

Manage speed and traffic flows with these fourteen essential signs.

Pack code - EE10218 14 Signs £215.00



600 x 400mm Qty 2



600 x 400mm Qty 2



600 x 400mm Qty 2



600 x 400mm Qty 2



600 x 400mm Qty 2



600 x 400mm Qty 2



600 x 400mm Qty 1



600 x 400mm Qty 1



Waste Management Pack

Vital signs to help maintain a tidy site with effective site waste management.

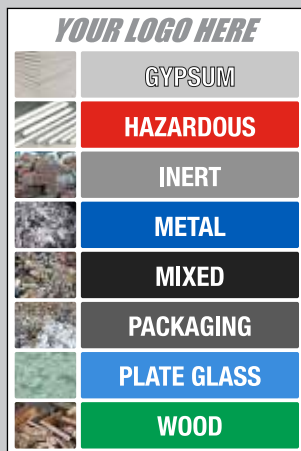
Pack code - EE10219 9 Signs **£150.00**

800 x 1200mm Qty 1



600 x 400mm Qty 1



600 x 400mm Qty 1



600 x 400mm Qty 1



600 x 400mm Qty 1



600 x 400mm Qty 1



600 x 400mm Qty 1



600 x 400mm Qty 1

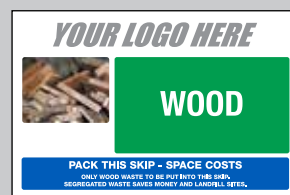

600 x 400mm Qty 1

NEW
PRODUCTNEW
PRODUCT

Pedestrian Route Pack

Minimise accidents involving pedestrians with clear guidance on your site.

Pack code - EE10220 25 Signs **£350.00**

600 x 400mm Qty 2



600 x 400mm Qty 4



600 x 400mm Qty 2



600 x 400mm Qty 2



600 x 400mm Qty 3



600 x 400mm Qty 3



600 x 400mm Qty 3



400 x 300mm Qty 4



600 x 400mm Qty 1



600 x 400mm Qty 1

Cost effective and easy to fit scaffolding signs are the perfect solution for when normal sign fixing is impractical. Being lightweight but rigid, the signs are made of 4mm Correx, using pre-cut tabs and slots the signs will remain secure in all weather conditions.



How to assemble



Remove your scaffolding sign from the packaging



Fold the top along the pre-pressed lines and wrap around scaffold pole



Insert tabs into the pre-cut slots to secure in place

£14.99 per sign

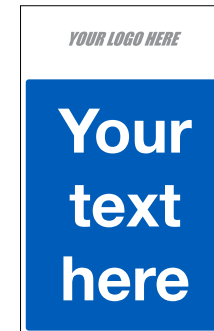

EE20100 400 x 600mm

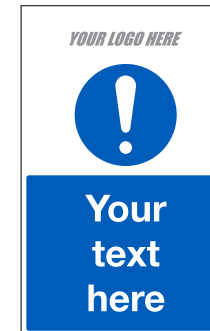

EE20102 400 x 600mm



EE20103 400 x 600mm



EE20104 400 x 600mm



EE20105 400 x 600mm



EE20106 400 x 600mm



EE20107 400 x 600mm



EE20108 400 x 600mm

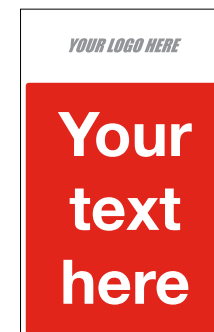

EE20109 400 x 600mm



EE20110 400 x 600mm

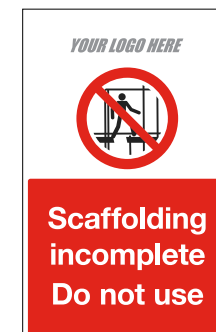

EE20111 400 x 600mm



EE20112 400 x 600mm

£14.99 per sign



EE20113 400 x 600mm



EE20114 400 x 600mm



EE20115 400 x 600mm



EE20116 400 x 600mm

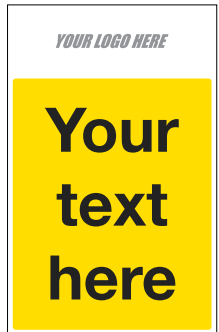

EE20117 400 x 600mm



EE20118 400 x 600mm



EE20119 400 x 600mm



EE20120 400 x 600mm



EE20121 400 x 600mm



EE20122 400 x 600mm



EE20123 400 x 600mm



EE20124 400 x 600mm

£14.99 per sign



EE20125 400 x 600mm



EE20126 400 x 600mm



EE20127 400 x 600mm



EE20128 400 x 600mm



EE20129 400 x 600mm



EE20130 400 x 600mm

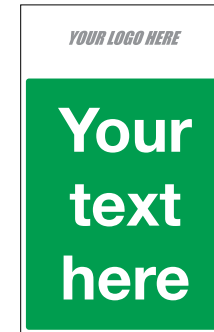

EE20131 400 x 600mm

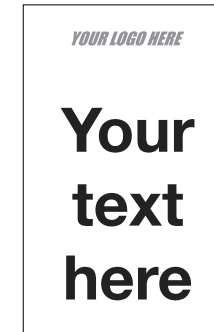

EE20132 400 x 600mm



SITE NAME *YOUR LOGO HERE*

All drivers and visitors please report to site agents office

Parents Building sites are dangerous Please keep your children away

Any person caught pilfering or causing damage on this development may be liable for prosecution

First aid First aid equipment kept in site office

Safety helmets must be worn

High visibility jackets must be worn

Protective footwear must be worn

We apologise for any inconvenience caused during development works

Site Manager

Emergency Contact

EE10214 2440 x 1220mm £142.00

YOUR LOGO HERE

SITE SAFETY

No hat, no boots, no job!
All visitors and delivery drivers must report to the site office

Danger Construction hazardous area

Head protection must be worn

Foot protection must be worn

Hi-viz clothing must be worn

No unauthorised persons beyond this point

Site speed limit

Emergency 24 hour telephone contact No.

EE10067 300 x 400mm
EE10068 400 x 600mm
EE10069 600 x 800mm

YOUR LOGO HERE

SITE SAFETY

Top quality is what our customers deserve - we provide it

Think quality - Get it right first time

Take pride in your work

Protect and re-cover all unfixed materials

We promote site safety

Please place your rubbish and packaging in the skips provided

No parking is permitted on site roads

We promote 'teamwork' on this development

EE10025 300 x 400mm
EE10026 400 x 600mm
EE10027 600 x 800mm

YOUR LOGO HERE

SITE SAFETY

All drivers and visitors please report to site agents office

Protective equipment must be worn by all personnel on this site

Parents Building sites are dangerous Please keep your children away

Any person caught pilfering or causing damage on this development may be liable for prosecution

First aid First aid equipment kept in site office

We apologise for any inconvenience caused during development works

EE10028 300 x 400mm
EE10029 400 x 600mm
EE10030 600 x 800mm

YOUR LOGO HERE

SITE NAME

All drivers and visitors please report to site agents office

Safety helmets must be worn

High visibility jackets must be worn

Protective footwear must be worn

Parents Building sites are dangerous Please keep your children away

Any person caught pilfering or causing damage on this development may be liable for prosecution

First aid First aid equipment kept in site office

We apologise for any inconvenience caused during development works

Site Manager

Emergency Contact

EE10213 1220 x 2440mm £142.00

YOUR LOGO HERE

This is the minimum required P.P.E. for this site!

Safety Helmet

Eye Protection

Protective Gloves

High Visibility Vest

Safety Footwear

NO EXCUSES

EE10215 800 x 1200mm £46.48



YOUR LOGO HERE

SITE SAFETY

Under the Health & Safety at Work Act 1974 all persons entering this site must comply with all regulations under this act. All visitors must report to the site office and obtain permission to proceed on to the site or any work area. Safety signs and procedures must be observed and personal protection and safety equipment must be used at all times.

Construction work in progress. Parents are advised to warn children of the dangers of entering this site.

Safety helmets must be worn

Protective footwear must be worn

High visibility jackets must be worn beyond this point

Unauthorised entry to this site is strictly forbidden

EE10196 300 x 400mm
EE10197 400 x 600mm
EE10198 600 x 800mm

YOUR LOGO HERE

SITE SAFETY

Heavy plant and machinery operate on this site

Vehicles must not enter the site without authority of the site supervisor. Unsupervised reversing in and out is strictly forbidden

Speed and parking restrictions must be observed

EE10199 400 x 300mm
EE10200 600 x 400mm
EE10201 800 x 600mm

Size in mm	300 x 400 400 x 300	400 x 600 600 x 400	600 x 800 800 x 600
Correx	4 mm 10mm	4 mm 10mm	4 mm 10mm
Prices	£7.99 £9.87	£13.45 £15.56	£19.79 £22.86

Please state thickness of correx required at time of ordering (10 mm or 4mm) using code /10 or /4 after product code. Example EE10001/10





EE10001 400 x 300mm
 EE10002 600 x 400mm
 EE10003 800 x 600mm



EE20031 400 x 300mm
 EE20032 600 x 400mm
 EE20033 800 x 600mm



EE20058 400 x 300mm
 EE20059 600 x 400mm
 EE20060 800 x 600mm



EE20061 400 x 300mm
 EE20062 600 x 400mm
 EE20063 800 x 600mm



EE10004 400 x 300mm
 EE10005 600 x 400mm
 EE10006 800 x 600mm



EE10013 400 x 300mm
 EE10014 600 x 400mm
 EE10015 800 x 600mm



EE30061 400 x 300mm
 EE30062 600 x 400mm
 EE30063 800 x 600mm



EE20082 400 x 300mm
 EE20083 600 x 400mm
 EE20084 800 x 600mm



EE10049 400 x 300mm
 EE10050 600 x 400mm
 EE10051 800 x 600mm



EE10193 400 x 300mm
 EE10194 600 x 400mm
 EE10195 800 x 600mm



EE20019 400 x 300mm
 EE20020 600 x 400mm
 EE20021 800 x 600mm



EE20085 400 x 300mm
 EE20086 600 x 400mm
 EE20087 800 x 600mm

Size in mm	300 x 400 400 x 300		400 x 600 600 x 400		600 x 800 800 x 600	
Correx	4 mm	10mm	4 mm	10mm	4 mm	10mm
Prices	£7.99	£9.87	£13.45	£15.56	£19.79	£22.86

Please state thickness of correx required at time of ordering (10 mm or 4mm) using code /10 or /4 after product code. Example EE10001/10



EE20022 400 x 300mm
 EE20023 600 x 400mm
 EE20024 800 x 600mm



EE20025 400 x 300mm
 EE20026 600 x 400mm
 EE20027 800 x 600mm



EE20028 400 x 300mm
 EE20029 600 x 400mm
 EE20030 800 x 600mm



EE20088 400 x 300mm
 EE20089 600 x 400mm
 EE20090 800 x 600mm

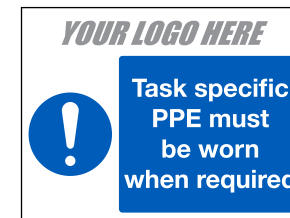

EE20091 400 x 300mm
 EE20092 600 x 400mm
 EE20093 800 x 600mm

We can print the CCS Logo on your branded signs FREE OF CHARGE





EE10007 400 x 300mm
 EE10008 600 x 400mm
 EE10009 800 x 600mm



EE10010 400 x 300mm
 EE10011 600 x 400mm
 EE10012 800 x 600mm



EE10019 400 x 300mm
 EE10020 600 x 400mm
 EE10021 800 x 600mm



EE10022 400 x 300mm
 EE10023 600 x 400mm
 EE10024 800 x 600mm



EE10016 400 x 300mm
 EE10017 600 x 400mm
 EE10018 800 x 600mm



EE10037 400 x 300mm
 EE10038 600 x 400mm
 EE10039 800 x 600mm



EE10031 400 x 300mm
 EE10032 600 x 400mm
 EE10033 800 x 600mm

Size in mm	300 x 400 400 x 300		400 x 600 600 x 400		600 x 800 800 x 600	
	4 mm	10mm	4 mm	10mm	4 mm	10mm
Prices	£7.99	£9.87	£13.45	£15.56	£19.79	£22.86

Please state thickness of correx required at time of ordering (10 mm or 4mm) using code /10 or /4 after product code. Example EE10016/10



EE10040 400 x 300mm
 EE10041 600 x 400mm
 EE10042 800 x 600mm



EE10043 400 x 300mm
 EE10044 600 x 400mm
 EE10045 800 x 600mm



EE10034 400 x 300mm
 EE10035 600 x 400mm
 EE10036 800 x 600mm



EE10070 400 x 300mm
 EE10071 600 x 400mm
 EE10072 800 x 600mm



EE10073 400 x 300mm
 EE10074 600 x 400mm
 EE10075 800 x 600mm



EE10076 400 x 300mm
 EE10077 600 x 400mm
 EE10078 800 x 600mm



EE10046 400 x 300mm
 EE10047 600 x 400mm
 EE10048 800 x 600mm



EE10052 400 x 300mm
 EE10053 600 x 400mm
 EE10054 800 x 600mm



EE10055 400 x 300mm
 EE10056 600 x 400mm
 EE10057 800 x 600mm



EE10079 400 x 300mm
 EE10080 600 x 400mm
 EE10081 800 x 600mm



EE10082 400 x 300mm
 EE10083 600 x 400mm
 EE10084 800 x 600mm



EE10085 400 x 300mm
 EE10086 600 x 400mm
 EE10087 800 x 600mm



EE10088 400 x 300mm
 EE10089 600 x 400mm
 EE10090 800 x 600mm



EE10091 400 x 300mm
 EE10092 600 x 400mm
 EE10093 800 x 600mm



EE10094 400 x 300mm
 EE10095 600 x 400mm
 EE10096 800 x 600mm



EE10121 400 x 300mm
 EE10122 600 x 400mm
 EE10123 800 x 600mm



EE10124 400 x 300mm
 EE10125 600 x 400mm
 EE10126 800 x 600mm



EE10127 400 x 300mm
 EE10128 600 x 400mm
 EE10129 800 x 600mm



EE10209 400 x 300mm
 EE10210 600 x 400mm
 EE10211 800 x 600mm



EE10097 400 x 300mm
 EE10098 600 x 400mm
 EE10099 800 x 600mm



EE10100 400 x 300mm
 EE10101 600 x 400mm
 EE10102 800 x 600mm



EE10130 400 x 300mm
 EE10131 600 x 400mm
 EE10132 800 x 600mm

Size in mm	300 x 400 400 x 300		400 x 600 600 x 400		600 x 800 800 x 600	
Correx	4 mm	10mm	4 mm	10mm	4 mm	10mm
Prices	£7.99	£9.87	£13.45	£15.56	£19.79	£22.86

Please state thickness of correx required at time of ordering (10 mm or 4mm) using code /10 or /4 after product code. Example EE10088/10



EE10103 400 x 300mm
 EE10104 600 x 400mm
 EE10105 800 x 600mm



EE10109 400 x 300mm
 EE10110 600 x 400mm
 EE10111 800 x 600mm



EE10112 400 x 300mm
 EE10113 600 x 400mm
 EE10114 800 x 600mm



EE10133 400 x 300mm
 EE10134 600 x 400mm
 EE10135 800 x 600mm



EE10136 400 x 300mm
 EE10137 600 x 400mm
 EE10138 800 x 600mm



EE10139 400 x 300mm
 EE10140 600 x 400mm
 EE10141 800 x 600mm



EE10106 400 x 300mm
 EE10107 600 x 400mm
 EE10108 800 x 600mm



EE10115 400 x 300mm
 EE10116 600 x 400mm
 EE10117 800 x 600mm



EE10118 400 x 300mm
 EE10119 600 x 400mm
 EE10120 800 x 600mm



EE10142 400 x 300mm
 EE10143 600 x 400mm
 EE10144 800 x 600mm



EE10145 400 x 300mm
 EE10146 600 x 400mm
 EE10147 800 x 600mm



EE10151 400 x 300mm
 EE10152 600 x 400mm
 EE10153 800 x 600mm



EE10148 400 x 300mm
 EE10149 600 x 400mm
 EE10150 800 x 600mm



EE10212 1000 x 600mm £34.00



EE10154 400 x 300mm
 EE10155 600 x 400mm
 EE10156 800 x 600mm



EE10157 400 x 300mm
 EE10158 600 x 400mm
 EE10159 800 x 600mm



EE10160 400 x 300mm
 EE10161 600 x 400mm
 EE10162 800 x 600mm

Size in mm	300 x 400 400 x 300		400 x 600 600 x 400		600 x 800 800 x 600	
Correx	4 mm	10mm	4 mm	10mm	4 mm	10mm
Prices	£7.99	£9.87	£13.45	£15.56	£19.79	£22.86

Please state thickness of correx required at time of ordering (10 mm or 4mm) using code /10 or /4 after product code. Example EE10154/10

Extend your safety messages to ALL access routes



EE10163 400 x 300mm
 EE10164 600 x 400mm
 EE10165 800 x 600mm



EE10166 400 x 300mm
 EE10167 600 x 400mm
 EE10168 800 x 600mm



EE10169 400 x 300mm
 EE10170 600 x 400mm
 EE10171 800 x 600mm



EE10181 400 x 300mm
 EE10182 600 x 400mm
 EE10183 800 x 600mm



EE10184 400 x 300mm
 EE10185 600 x 400mm
 EE10186 800 x 600mm



EE20034 400 x 300mm
 EE20035 600 x 400mm
 EE20036 800 x 600mm



EE10172 400 x 300mm
 EE10173 600 x 400mm
 EE10174 800 x 600mm



EE10175 400 x 300mm
 EE10176 600 x 400mm
 EE10177 800 x 600mm



EE10178 400 x 300mm
 EE10179 600 x 400mm
 EE10180 800 x 600mm

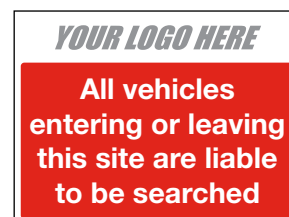

EE10187 400 x 300mm
 EE10188 600 x 400mm
 EE10189 800 x 600mm



EE10190 400 x 300mm
 EE10191 600 x 400mm
 EE10192 800 x 600mm



EE20094 400 x 300mm
 EE20095 600 x 400mm
 EE20096 800 x 600mm



EE20001 400 x 300mm
EE20002 600 x 400mm
EE20003 800 x 600mm



EE20004 400 x 300mm
EE20005 600 x 400mm
EE20006 800 x 600mm



EE20007 400 x 300mm
EE20008 600 x 400mm
EE20009 800 x 600mm



EE10064 400 x 300mm
EE10065 600 x 400mm
EE10066 800 x 600mm



EE10061 400 x 300mm
EE10062 600 x 400mm
EE10063 800 x 600mm



EE20055 400 x 300mm
EE20056 600 x 400mm
EE20057 800 x 600mm



EE20043 400 x 300mm
EE20044 600 x 400mm
EE20045 800 x 600mm



EE20046 400 x 300mm
EE20047 600 x 400mm
EE20048 800 x 600mm



EE20052 400 x 300mm
EE20053 600 x 400mm
EE20054 800 x 600mm



EE30058 400 x 300mm
EE30059 600 x 400mm
EE30060 800 x 600mm



EE20067 400 x 300mm
EE20068 600 x 400mm
EE20069 800 x 600mm



EE20049 400 x 300mm
EE20050 600 x 400mm
EE20051 800 x 600mm



EE20040 400 x 300mm
EE20041 600 x 400mm
EE20042 800 x 600mm



EE20010 400 x 300mm
EE20011 600 x 400mm
EE20012 800 x 600mm



EE20070 400 x 300mm
EE20071 600 x 400mm
EE20072 800 x 600mm

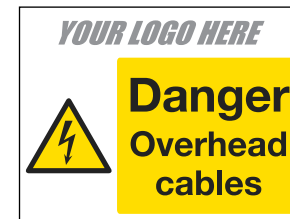

EE20079 400 x 300mm
EE20080 600 x 400mm
EE20081 800 x 600mm



EE20076 400 x 300mm
EE20077 600 x 400mm
EE20078 800 x 600mm



EE20013 400 x 300mm
EE20014 600 x 400mm
EE20015 800 x 600mm



EE20016 400 x 300mm
EE20017 600 x 400mm
EE20018 800 x 600mm



EE10058 400 x 300mm
EE10059 600 x 400mm
EE10060 800 x 600mm



EE20097 400 x 300mm
EE20098 600 x 400mm
EE20099 800 x 600mm

Size in mm	300 x 400		400 x 600		600 x 800	
	400 x 300	400 x 400	600 x 400	600 x 600	800 x 600	800 x 800
Correx	4 mm	10mm	4 mm	10mm	4 mm	10mm
Prices	£7.99	£9.87	£13.45	£15.56	£19.79	£22.86

Please state thickness of correx required at time of ordering (10 mm or 4mm) using code /10 or /4 after product code. Example EE10154/10

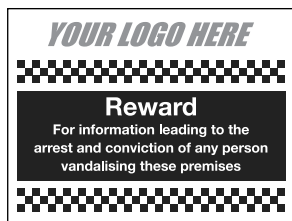

EE30001 400 x 300mm
 EE30002 600 x 400mm
 EE30003 800 x 600mm



EE30004 400 x 300mm
 EE30005 600 x 400mm
 EE30006 800 x 600mm



EE30007 400 x 300mm
 EE30008 600 x 400mm
 EE30009 800 x 600mm

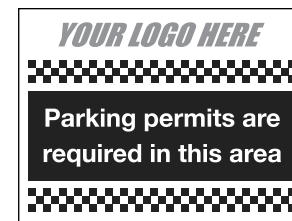

EE30034 400 x 300mm
 EE30035 600 x 400mm
 EE30036 800 x 600mm



EE30010 400 x 300mm
 EE30011 600 x 400mm
 EE30012 800 x 600mm



EE30013 400 x 300mm
 EE30014 600 x 400mm
 EE30015 800 x 600mm



EE30037 400 x 300mm
 EE30038 600 x 400mm
 EE30039 800 x 600mm



EE30040 400 x 300mm
 EE30041 600 x 400mm
 EE30042 800 x 600mm



EE30043 400 x 300mm
 EE30044 600 x 400mm
 EE30045 800 x 600mm

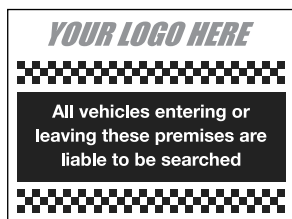

EE30016 400 x 300mm
 EE30017 600 x 400mm
 EE30018 800 x 600mm



EE30019 400 x 300mm
 EE30020 600 x 400mm
 EE30021 800 x 600mm



EE30022 400 x 300mm
 EE30023 600 x 400mm
 EE30024 800 x 600mm



EE30046 400 x 300mm
 EE30047 600 x 400mm
 EE30048 800 x 600mm



EE30049 400 x 300mm
 EE30050 600 x 400mm
 EE30051 800 x 600mm



EE30052 400 x 300mm
 EE30053 600 x 400mm
 EE30054 800 x 600mm



EE30025 400 x 300mm
 EE30026 600 x 400mm
 EE30027 800 x 600mm



EE30028 400 x 300mm
 EE30029 600 x 400mm
 EE30030 800 x 600mm



EE30031 400 x 300mm
 EE30032 600 x 400mm
 EE30033 800 x 600mm



EE30055 400 x 300mm
 EE30056 600 x 400mm
 EE30057 800 x 600mm

Size in mm	300 x 400 400 x 300	400 x 600 600 x 400	600 x 800 800 x 600
Correx	4 mm 10mm	4 mm 10mm	4 mm 10mm
Prices	£7.99 £9.87	£13.45 £15.56	£19.79 £22.86

Please state thickness of correx required at time of ordering (10 mm or 4mm) using code /10 or /4 after product code. Example EE30001/10



EE40001 400 x 300mm
 EE40002 600 x 400mm
 EE40003 800 x 600mm



EE40004 400 x 300mm
 EE40005 600 x 400mm
 EE40006 800 x 600mm



EE40007 400 x 300mm
 EE40008 600 x 400mm
 EE40009 800 x 600mm



EE40037 400 x 300mm
 EE40038 600 x 400mm
 EE40039 800 x 600mm



EE40010 400 x 300mm
 EE40011 600 x 400mm
 EE40012 800 x 600mm



EE40013 400 x 300mm
 EE40014 600 x 400mm
 EE40015 800 x 600mm



EE40016 400 x 300mm
 EE40017 600 x 400mm
 EE40018 800 x 600mm



EE40040 400 x 300mm
 EE40041 600 x 400mm
 EE40042 800 x 600mm



EE40019 400 x 300mm
 EE40020 600 x 400mm
 EE40021 800 x 600mm



EE40022 400 x 300mm
 EE40023 600 x 400mm
 EE40024 800 x 600mm



EE40025 400 x 300mm
 EE40026 600 x 400mm
 EE40027 800 x 600mm



EE40043 400 x 300mm
 EE40044 600 x 400mm
 EE40045 800 x 600mm



EE40028 400 x 300mm
 EE40029 600 x 400mm
 EE40030 800 x 600mm



EE40031 400 x 300mm
 EE40032 600 x 400mm
 EE40033 800 x 600mm



EE40034 400 x 300mm
 EE40035 600 x 400mm
 EE40036 800 x 600mm



EE40046 400 x 300mm
 EE40047 600 x 400mm
 EE40048 800 x 600mm



Size in mm	300 x 400 400 x 300		400 x 600 600 x 400		600 x 800 800 x 600	
Correx	4 mm	10mm	4 mm	10mm	4 mm	10mm
Prices	£7.99	£9.87	£13.45	£15.56	£19.79	£22.86

Please state thickness of correx required at time of ordering (10 mm or 4mm) using code /10 or /4 after product code. Example EE40001/10



EE40049 130 x 600mm £6.50 x1
 EE40050 130 x 600mm £52.00 x10
 EE40051 130 x 600mm £260.00 x50

**CALL US FREE ON
01737 774 077**



EE40052 130 x 600mm £6.50 x1
 EE40053 130 x 600mm £52.00 x10
 EE40054 130 x 600mm £260.00 x50

CABLE TIES

For attaching signs to railings, fencing or equipment where screw fixing or self-adhesive backing is impractical. Each tie is 280mm long and they are sold in packs of 100.

EE90119 £6.80



EE40055 130 x 600mm £6.50 x1
 EE40056 130 x 600mm £52.00 x10
 EE40057 130 x 600mm £260.00 x50



EE40058 130 x 600mm £6.50 x1
 EE40059 130 x 600mm £52.00 x10
 EE40060 130 x 600mm £260.00 x50



EE30064 600 x 450mm



EE30065 600 x 450mm



EE30066 600 x 450mm



EE30076 600 x 450mm



EE30077 600 x 450mm



EE30078 600 x 450mm



EE30067 600 x 450mm



EE30068 600 x 450mm



EE30069 600 x 450mm



EE30079 600 x 450mm



EE30080 600 x 450mm



EE30081 600 x 450mm



EE30070 600 x 450mm



EE30071 600 x 450mm



EE30072 600 x 450mm



EE30082 1050 x 750mm



EE30083 1050 x 750mm



EE30084 1050 x 750mm



EE30073 600 x 450mm



EE30074 600 x 450mm



EE30075 600 x 450mm



EE30085 1050 x 750mm

Size in mm	600 x 450	1050 x 750
Aluminium Composite	£18.00	£38.00



FREE STANDING FRAMES

Frames are available in 2 sizes:

- 1050 x 750mm
- 600 x 450mm

Frame prices only

Size in mm	1050 x 750	600 x 450
Code	6727299	6726153RN(B)
Prices	£30.65	£22.50



EE30086 1050 x 750mm



EE30087 1050 x 750mm



EE30088 1050 x 750mm



EE30098 1050 x 750mm



EE30099 1050 x 750mm



EE30100 1050 x 750mm



EE30089 1050 x 750mm



EE30090 1050 x 750mm



EE30091 1050 x 750mm



EE30101 1050 x 750mm



EE30102 1050 x 750mm



EE30103 1050 x 750mm



EE30092 1050 x 750mm



EE30093 1050 x 750mm



EE30094 1050 x 750mm



EE30095 1050 x 750mm



EE30096 1050 x 750mm



EE30097 1050 x 750mm



Size in mm	600 x 450	1050 x 750
Aluminium Composite	£18.00	£38.00

Would your site benefit from LED Signs?

Turn to page 63 to find out more.



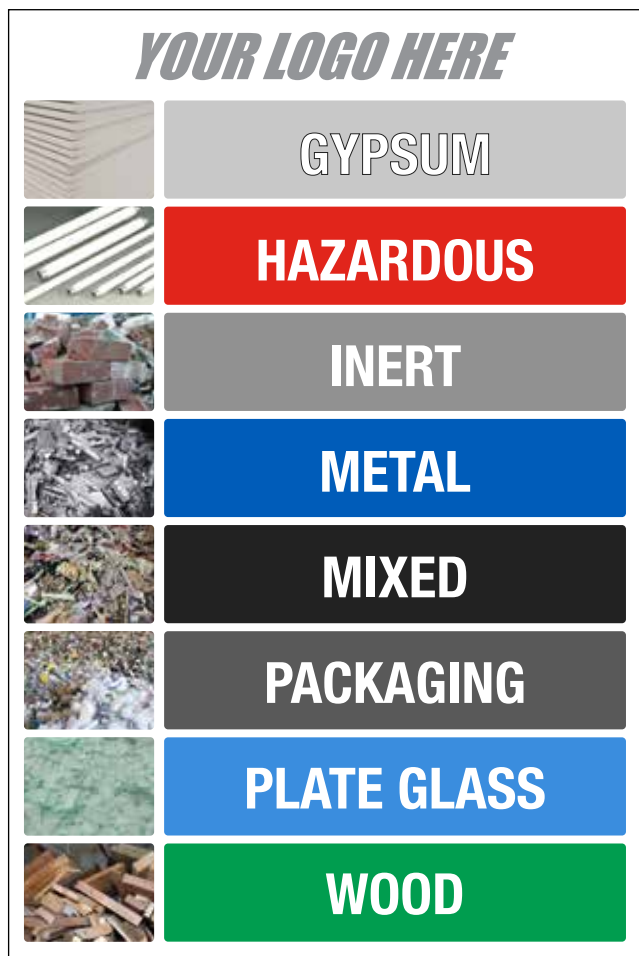

EE50040 800 x 1200m

Size in mm	600 x 400	800 x 1200
Correx 10mm	£15.56	£46.48

**CALL US FREE ON
01737 774 077**



EE50041 600 x 400mm



EE50042 600 x 400mm



EE50043 600 x 400mm



EE50044 600 x 400mm

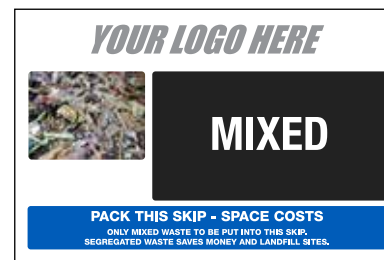

EE50045 600 x 400mm



EE50046 600 x 400mm



EE50047 600 x 400mm

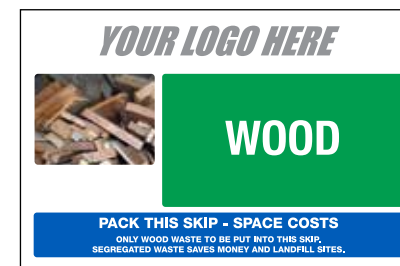

EE50048 600 x 400mm



Size in mm	300 x 400 400 x 300		400 x 600 600 x 400		600 x 800 800 x 600		
	Correx	4 mm	10mm	4 mm	10mm	4 mm	10mm
Prices	£7.99	£9.87	£13.45	£15.56	£19.79	£22.86	

Please state thickness of correx required at time of ordering (10 mm or 4mm) using code /10 or /4 after product code. Example EE50001/10



- EE50001 400 x 300mm
- EE50002 600 x 400mm
- EE50003 800 x 600mm



- EE50019 400 x 300mm
- EE50020 600 x 400mm
- EE50021 800 x 600mm



- EE50022 400 x 300mm
- EE50023 600 x 400mm
- EE50024 800 x 600mm



- EE50025 400 x 300mm
- EE50026 600 x 400mm
- EE50027 800 x 600mm



- EE50004 400 x 300mm
- EE50005 600 x 400mm
- EE50006 800 x 600mm



- EE50028 400 x 300mm
- EE50029 600 x 400mm
- EE50030 800 x 600mm



- EE50031 400 x 300mm
- EE50032 600 x 400mm
- EE50033 800 x 600mm



- EE50037 400 x 300mm
- EE50038 600 x 400mm
- EE50039 800 x 600mm



- EE50007 400 x 300mm
- EE50008 600 x 400mm
- EE50009 800 x 600mm



- EE50010 400 x 300mm
- EE50011 600 x 400mm
- EE50012 800 x 600mm



- EE50034 400 x 300mm
- EE50035 600 x 400mm
- EE50036 800 x 600mm



- EE50013 400 x 300mm
- EE50014 600 x 400mm
- EE50015 800 x 600mm



- EE50016 400 x 300mm
- EE50017 600 x 400mm
- EE50018 800 x 600mm



Fast identification of personnel



- EE60001 50 x 50mm £5.50 x10
- EE60002 50 x 50mm £45.00 x100
- EE60003 50 x 50mm £80.00 x250



- EE60004 50 x 50mm £5.50 x10
- EE60005 50 x 50mm £45.00 x100
- EE60006 50 x 50mm £80.00 x250

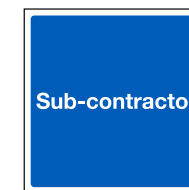

- EE60007 50 x 50mm £5.50 x10
- EE60008 50 x 50mm £45.00 x100
- EE60009 50 x 50mm £80.00 x250



- EE60010 50 x 50mm £5.50 x10
- EE60011 50 x 50mm £45.00 x100
- EE60012 50 x 50mm £80.00 x250



- EE60013 50 x 50mm £5.50 x10
- EE60014 50 x 50mm £45.00 x100
- EE60015 50 x 50mm £80.00 x250

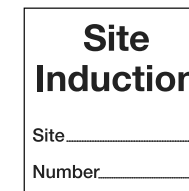

- EE60016 50 x 50mm £5.50 x10
- EE60017 50 x 50mm £45.00 x100
- EE60018 50 x 50mm £80.00 x250



EE70001 400 x 300mm
 EE70002 600 x 400mm
 EE70003 800 x 600mm



EE70004 400 x 300mm
 EE70005 600 x 400mm
 EE70006 800 x 600mm



EE70007 400 x 300mm
 EE70008 600 x 400mm
 EE70009 800 x 600mm



EE70037 400 x 300mm
 EE70038 600 x 400mm
 EE70039 800 x 600mm



EE70034 400 x 300mm
 EE70035 600 x 400mm
 EE70036 800 x 600mm



EE70040 400 x 300mm
 EE70041 600 x 400mm
 EE70042 800 x 600mm



EE70010 400 x 300mm
 EE70011 600 x 400mm
 EE70012 800 x 600mm



EE70013 400 x 300mm
 EE70014 600 x 400mm
 EE70015 800 x 600mm



EE70016 400 x 300mm
 EE70017 600 x 400mm
 EE70018 800 x 600mm



EE70043 400 x 300mm
 EE70044 600 x 400mm
 EE70045 800 x 600mm



EE70046 400 x 300mm
 EE70047 600 x 400mm
 EE70048 800 x 600mm



EE70091 400 x 300mm
 EE70092 600 x 400mm
 EE70093 800 x 600mm



EE70019 400 x 300mm
 EE70020 600 x 400mm
 EE70021 800 x 600mm



EE70022 400 x 300mm
 EE70023 600 x 400mm
 EE70024 800 x 600mm



EE70025 400 x 300mm
 EE70026 600 x 400mm
 EE70027 800 x 600mm



EE70094 400 x 300mm
 EE70095 600 x 400mm
 EE70096 800 x 600mm



EE70097 400 x 300mm
 EE70098 600 x 400mm
 EE70099 800 x 600mm



EE70100 400 x 300mm
 EE70101 600 x 400mm
 EE70102 800 x 600mm



EE70028 400 x 300mm
 EE70029 600 x 400mm
 EE70030 800 x 600mm



EE70031 400 x 300mm
 EE70032 600 x 400mm
 EE70033 800 x 600mm

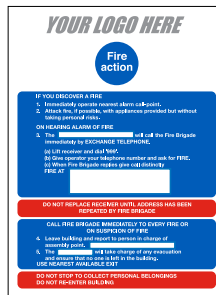

EE70070 300 x 400mm
 EE70071 400 x 600mm
 EE70072 600 x 800mm



EE70103 400 x 300mm
 EE70104 600 x 400mm
 EE70105 800 x 600mm

Size in mm	300 x 400		400 x 600		600 x 800	
	400 x 300	600 x 400	600 x 400	800 x 600	800 x 600	800 x 600
Correx	4 mm	10mm	4 mm	10mm	4 mm	10mm
Prices	£7.99	£9.87	£13.45	£15.56	£19.79	£22.86

Please state thickness of correx required at time of ordering (10 mm or 4mm) using code /10 or /4 after product code. Example EE70001/10



Signs are essential to your evacuation procedure

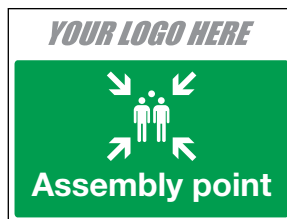

EE70049 400 x 300mm
 EE70050 600 x 400mm
 EE70051 800 x 600mm

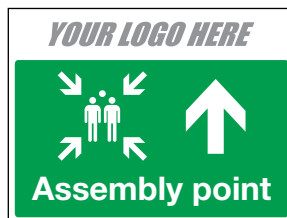

EE70052 400 x 300mm
 EE70053 600 x 400mm
 EE70054 800 x 600mm



EE70073 400 x 300mm
 EE70074 600 x 400mm
 EE70075 800 x 600mm



EE70076 400 x 300mm
 EE70077 600 x 400mm
 EE70078 800 x 600mm

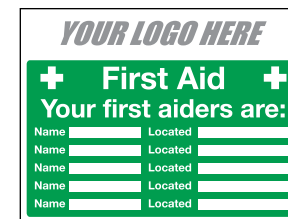

EE70079 400 x 300mm
 EE70080 600 x 400mm
 EE70081 800 x 600mm



EE70082 400 x 300mm
 EE70083 600 x 400mm
 EE70084 800 x 600mm



EE70085 400 x 300mm
 EE70086 600 x 400mm
 EE70087 800 x 600mm



EE70088 400 x 300mm
 EE70089 600 x 400mm
 EE70090 800 x 600mm



EE70055 400 x 300mm
 EE70056 600 x 400mm
 EE70057 800 x 600mm

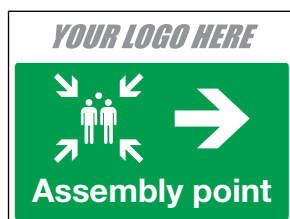

EE70058 400 x 300mm
 EE70059 600 x 400mm
 EE70060 800 x 600mm

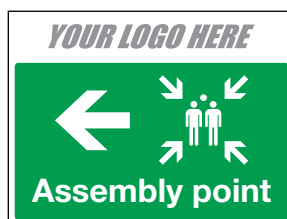

EE70061 400 x 300mm
 EE70062 600 x 400mm
 EE70063 800 x 600mm



EE70064 400 x 300mm
 EE70065 600 x 400mm
 EE70066 800 x 600mm



EE70067 400 x 300mm
 EE70068 600 x 400mm
 EE70069 800 x 600mm



EE70106 400 x 300mm
 EE70107 600 x 400mm
 EE70108 800 x 600mm

Enviro Signs
 Recyclable display boards & hoarding

Our signs are also now available on NON - PVC BUBBLE BOARD

The Enviro Signs Bubble board is sturdy and rigid with a smooth print finish and excellent display appearance.

Being 100% recyclable the bubble board is 3mm thick and offers a hard-wearing temporary signage alternative to conventional plastic and foam boards.

Size in mm	300 x 400 400 x 300	400 x 600 600 x 400	600 x 800 800 x 600
Correx	4 mm 10mm	4 mm 10mm	4 mm 10mm
Prices	£7.99 £9.87	£13.45 £15.56	£19.79 £22.86

Please state thickness of correx required at time of ordering (10 mm or 4mm) using code /10 or /4 after product code. Example EE70055/10

“The signs are very durable and look good as they incorporate the company logo at no extra cost. Service is very good and delivery is very quick.”
 David Morgan, Buyer (AD Construction Group)





EE80001 400 x 300mm
EE80002 600 x 400mm
EE80003 800 x 600mm



EE80004 400 x 300mm
EE80005 600 x 400mm
EE80006 800 x 600mm



EE80007 400 x 300mm
EE80008 600 x 400mm
EE80009 800 x 600mm



EE80031 400 x 300mm
EE80032 600 x 400mm
EE80033 800 x 600mm

Size in mm	300 x 400 400 x 300	400 x 600 600 x 400	600 x 800 800 x 600
Correx	4 mm 10mm	4 mm 10mm	4 mm 10mm
Prices	£7.99 £9.87	£13.45 £15.56	£19.79 £22.86

Please state thickness of correx required at time of ordering (10 mm or 4mm) using code /10 or /4 after product code. Example EE80001/10



EE80010 400 x 300mm
EE80011 600 x 400mm
EE80012 800 x 600mm



EE80013 400 x 300mm
EE80014 600 x 400mm
EE80015 800 x 600mm



EE80016 400 x 300mm
EE80017 600 x 400mm
EE80018 800 x 600mm



EE80034 400 x 300mm
EE80035 600 x 400mm
EE80036 800 x 600mm



EE80037 400 x 300mm
EE80038 600 x 400mm
EE80039 800 x 600mm



EE80040 400 x 300mm
EE80041 600 x 400mm
EE80042 800 x 600mm



EE80019 400 x 300mm
EE80020 600 x 400mm
EE80021 800 x 600mm



EE80022 400 x 300mm
EE80023 600 x 400mm
EE80024 800 x 600mm

CABLE TIES



For attaching signs to railings, fencing or equipment where screw fixing or self-adhesive backing is impractical. Each tie is 280mm long and they are sold in packs of 100.

EE90119 | £6.80



EE80043 400 x 300mm
EE80044 600 x 400mm
EE80045 800 x 600mm



EE80046 400 x 300mm
EE80047 600 x 400mm
EE80048 800 x 600mm



EE80049 400 x 300mm
EE80050 600 x 400mm
EE80051 800 x 600mm



EE80025 400 x 300mm
EE80026 600 x 400mm
EE80027 800 x 600mm



EE80028 400 x 300mm
EE80029 600 x 400mm
EE80030 800 x 600mm

CALL US FREE ON
01737 774 741



EE80052 400 x 300mm
EE80053 600 x 400mm
EE80054 800 x 600mm



EE80055 400 x 300mm
EE80056 600 x 400mm
EE80057 800 x 600mm



EE80058 400 x 300mm
EE80059 600 x 400mm
EE80060 800 x 600mm

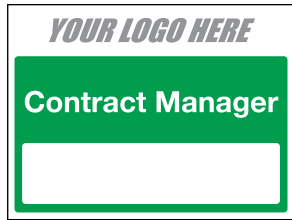

EE80061 400 x 300mm
 EE80062 600 x 400mm
 EE80063 800 x 600mm



EE80064 400 x 300mm
 EE80065 600 x 400mm
 EE80066 800 x 600mm



EE80067 400 x 300mm
 EE80068 600 x 400mm
 EE80069 800 x 600mm



EE80166 £4.76



EE80070 400 x 300mm
 EE80071 600 x 400mm
 EE80072 800 x 600mm



EE80073 400 x 300mm
 EE80074 600 x 400mm
 EE80075 800 x 600mm



EE80076 400 x 300mm
 EE80077 600 x 400mm
 EE80078 800 x 600mm

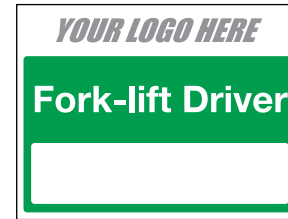

EE80079 400 x 300mm
 EE80080 600 x 400mm
 EE80081 800 x 600mm

Size in mm	300 x 400 400 x 300		400 x 600 600 x 400		600 x 800 800 x 600	
Correx	4 mm	10mm	4 mm	10mm	4 mm	10mm
Prices	£7.99	£9.87	£13.45	£15.56	£19.79	£22.86

Please state thickness of correx required at time of ordering (10 mm or 4mm) using code /10 or /4 after product code. Example EE80061/10



EE80082 400 x 300mm
 EE80083 600 x 400mm
 EE80084 800 x 600mm



EE80085 400 x 300mm
 EE80086 600 x 400mm
 EE80087 800 x 600mm



EE80088 400 x 300mm
 EE80089 600 x 400mm
 EE80090 800 x 600mm



EE80091 400 x 300mm
 EE80092 600 x 400mm
 EE80093 800 x 600mm



EE80094 400 x 300mm
 EE80095 600 x 400mm
 EE80096 800 x 600mm



EE20064 400 x 300mm
 EE20065 600 x 400mm
 EE20066 800 x 600mm

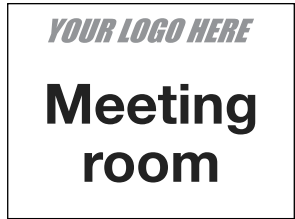

EE80097 400 x 300mm
 EE80098 600 x 400mm
 EE80099 800 x 600mm



EE80100 400 x 300mm
 EE80101 600 x 400mm
 EE80102 800 x 600mm



EE80103 400 x 300mm
 EE80104 600 x 400mm
 EE80105 800 x 600mm



EE80106 400 x 300mm
 EE80107 600 x 400mm
 EE80108 800 x 600mm



EE80109 400 x 300mm
 EE80110 600 x 400mm
 EE80111 800 x 600mm



EE80112 400 x 300mm
 EE80113 600 x 400mm
 EE80114 800 x 600mm

Size in mm	300 x 400		400 x 600		600 x 800	
	400 x 300	600 x 400	400 x 300	600 x 400	800 x 600	600 x 800
Correx	4 mm	10mm	4 mm	10mm	4 mm	10mm
Prices	£7.99	£9.87	£13.45	£15.56	£19.79	£22.86

Please state thickness of correx required at time of ordering (10 mm or 4mm) using code /10 or /4 after product code. Example EE80097/10



EE80115 400 x 300mm
 EE80116 600 x 400mm
 EE80117 800 x 600mm

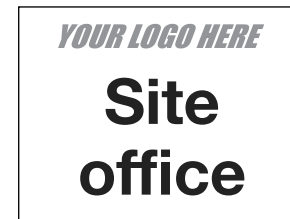

EE80118 400 x 300mm
 EE80119 600 x 400mm
 EE80120 800 x 600mm



EE80121 400 x 300mm
 EE80122 600 x 400mm
 EE80123 800 x 600mm



EE80124 400 x 300mm
 EE80125 600 x 400mm
 EE80126 800 x 600mm



EE80167 400 x 300mm
 EE80168 600 x 400mm
 EE80169 800 x 600mm



EE20037 400 x 300mm
 EE20038 600 x 400mm
 EE20039 800 x 600mm





EE80145 400 x 300mm
 EE80146 600 x 400mm
 EE80147 800 x 600mm



EE80148 400 x 300mm
 EE80149 600 x 400mm
 EE80150 800 x 600mm



Size in mm	300 x 400 400 x 300		400 x 600 600 x 400		600 x 800 800 x 600	
Correx	4 mm	10mm	4 mm	10mm	4 mm	10mm
Prices	£7.99	£9.87	£13.45	£15.56	£19.79	£22.86

Please state thickness of correx required at time of ordering (10 mm or 4mm) using code /10 or /4 after product code. Example EE80127/10

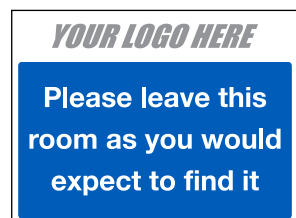

EE80127 400 x 300mm
 EE80128 600 x 400mm
 EE80129 800 x 600mm



EE80130 400 x 300mm
 EE80131 600 x 400mm
 EE80132 800 x 600mm



EE80133 400 x 300mm
 EE80134 600 x 400mm
 EE80135 800 x 600mm



EE80151 400 x 300mm
 EE80152 600 x 400mm
 EE80153 800 x 600mm

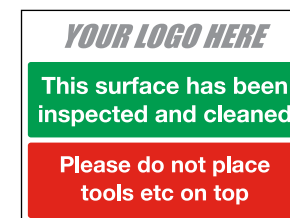

EE80154 400 x 300mm
 EE80155 600 x 400mm
 EE80156 800 x 600mm



EE80157 400 x 300mm
 EE80158 600 x 400mm
 EE80159 800 x 600mm



EE80136 400 x 300mm
 EE80137 600 x 400mm
 EE80138 800 x 600mm



EE80139 400 x 300mm
 EE80140 600 x 400mm
 EE80141 800 x 600mm



EE80142 400 x 300mm
 EE80143 600 x 400mm
 EE80144 800 x 600mm



EE80160 400 x 300mm
 EE80161 600 x 400mm
 EE80162 800 x 600mm



EE80163 400 x 300mm
 EE80164 600 x 400mm
 EE80165 800 x 600mm



YOUR LOGO HERE

Site Name:	Date:
Site Hazards:	Control Measures:
Site News / Initiatives / Safety Critical Operations	
If you see anything unsafe, please contact:	

YOUR LOGO HERE

DAILY ACTIVITY BRIEFING BOARD

Task	Location Area	Contractor Name	Supervisor Name	Documentation <small>(Permit - Permit - Safety Documents)</small>
Site Hazards	Control Measures	Weather Risks		

EE90001 1220 x 900mm £54.00 Correx

EE90010 1200 x 900mm £54.00 Correx

YOUR LOGO HERE

Site Rules

Principal Contractor

Under the Health and Safety at Work Act, All persons entering this site must comply with all regulations under this act.

All visitors must report to the site office and obtain permission to proceed on to site or the work area.

Safety signs and procedures must be observed and personal protection and safety equipment must be used at all times.

Prior to entering the site all persons must undergo a specific site induction.

All incidents/hazards/near misses must be reported to site management.

- Safety helmets must be worn at all times
- Protective footwear must be worn at all times
- High visibility clothing must be worn at all times
- Eye protection must be worn at all times
- Hand protection must be worn at all times
- Protective clothing must be worn at all times

Unauthorized entry to this site is strictly forbidden

EE90002 1800 x 1220mm £125.00 Correx

YOUR LOGO HERE

Do you need an induction?

Company name	YES
Visitor	YES
3rd party Contractor	YES
Everyone	YES

EE90003 400 x 300mm £9.87
 EE90004 600 x 400mm £15.56
 EE90005 800 x 600mm £22.86

YOUR LOGO HERE

What you said:	What we did:

EE90007 400 x 300mm £9.87
 EE90008 600 x 400mm £15.56
 EE90009 800 x 600mm £22.86

MARKER PENS

EE80166 £4.76



EE90203 2440 x 1220mm £145.00

Material - 10mm correx
 Includes Health and Safety Law poster

- Includes digitally printed:
- Electric Shock Emergency Action Notice
 - Fire Action Notice
 - First Aider Details
 - Emergency Service Details

Plastic pockets for:

- F10 Form
- Insurance Certificate
- Health and Safety Policy
- Site Induction Register
- Scaffold & Plant Register
- Lifting Equipment Register
- Fire Evacuation / Fire Plan
- Accident Book

It is also possible to amend/ bespoke this Site Safety Notice Board and tailor it to your individual needs.

CABLE TIES

For attaching signs to railings, fencing or equipment where screw fixing or self-adhesive backing is impractical. Each tie is 280mm long and they are sold in packs of 100.

EE90119 £6.80

HEALTH & SAFETY LAW POSTER

You have a legal obligation to display this poster in a prominent position in each workplace.

The poster is available in A2 size £17.50 per poster.

YOUR LOGO HERE

CONSTRUCTION SITE SAFETY SITE MANAGERS SAFETY CHECKLIST

This checklist reviews sites of the highest risk currently based on construction sites. The intention is only to help you decide whether your site is a safe and healthy place to work. It is not an exhaustive list. More detailed information can be found in HSE's Health and Safety in Construction and other HSE publications.

Safe places of work	Manual handling	Hazardous substances
Cranes and lifting appliances	Hoists	Noise
Powered access equipment	Scaffolds	Wellbeing
Ladders	Plant and machinery	Electricity
Roof work	Traffic and vehicles	Fire and emergencies
Excavations	Protecting the public	Fire

EE90202 600 x 900mm £29.00
Correx

YOUR LOGO HERE

ACCIDENT MAN

HEAD INJURIES THIS MONTH
IN TOTAL

EYE INJURIES THIS MONTH
IN TOTAL

BACK INJURIES THIS MONTH
IN TOTAL

ARM INJURIES THIS MONTH
IN TOTAL

LEG INJURIES THIS MONTH
IN TOTAL

HAND/FINGER INJURIES THIS MONTH
IN TOTAL

OTHER INJURIES THIS MONTH
IN TOTAL

FOOT/ANKLE INJURIES THIS MONTH
IN TOTAL

STATISTICS COMMENCE FROM

EE90204 800 x 1200mm £46.48
Correx

YOUR LOGO HERE **CRANE INFORMATION BOARD**

Information Updated: _____ Commencement Date: _____ Completion Date: _____

PERSONNEL INFORMATION	TOWER CRANE 1	TOWER CRANE 2	TOWER CRANE 3	LIFT PLAN
DRIVER				LIFT PLAN
RELIEF DRIVER				
SLINGER / SIGNALLER				LIFT PLAN
BANKSMAN 1				
BANKSMAN 2				
LIFT SUPERVISOR				
APPOINTED PERSON				
RESCUE TEAM				
EMERGENCY RESCUE TEAM TELEPHONE NUMBER				
CRANE INFORMATION	TOWER CRANE 1	TOWER CRANE 2	TOWER CRANE 3	
SERIAL NUMBER				
DATE OF LAST THOROUGH EXAMINATION				
DATE OF NEXT THOROUGH EXAMINATION				

EE90205 900 x 600mm £60.00
Aluminium Composite

COMPANY LOGOS INCLUDED FREE OF CHARGE

At time of ordering just send us a high-res PDF/ jpeg or an eps/ai file of your logo

SITE TRAFFIC & ENVIRONMENTAL PLAN

Traffic Plan Updates

1
2
3
4
5
6
7
8
9
10

Compound Plan

Key: Pedestrian Route Crossing Point Storage Area Boundary Fence
 Car Parking Compound Sales Centre Traffic Route(s)

YOUR LOGO HERE

EE90206 1200 x 800mm £85.00
Aluminium Composite

Subcontractor SHEQ Performance Monitor **YOUR LOGO HERE**

Guide to individual ratings	5 Excellent	4 Good	3 Acceptable	2 Poor	1 Unacceptable	0 Total / repeated failure to deliver							
Guide to overall ratings	37-44 = Good (green)			25-36 = Average (amber)		0-28 = Poor (red)							
Sub Contractor	Method Statements / Risk Assessments	Safe Working Practices	Supervision	Housekeeping	PPE	Tool Box Talks	HSE/DAE Inspections	Quality of Documentation	Quality of Workmanship	Excavations - Control of SWMP	Waste / SWMP	Previous Months Score	Total Monthly Score

The project Manager must complete the company standards section below at the end of month

Company Standards	Red / Amber / Green / Blue Status	Reasons / Actions
Non Company Standards		
Improvement Required		
Standards Achieved		

EE90207 1800 x 1200mm £160.00
Aluminium Composite

Occupational welfare board **YOUR LOGO HERE**

EE90208 1200 x 800mm £90.00
Aluminium Composite

Local information board **YOUR LOGO HERE**

EE90209 1200 x 800mm £90.00
Aluminium Composite

A selection of the main principal contractor signs and safety noticeboards are pictured, but we can produce bespoke signs and boards in different materials and sizes on request.

We can print the CCS Logo on your branded signs FREE OF CHARGE



MARKER PENS

EE80166 £4.76



Stackboards are used to advertise larger projects with longer lead times. Our Graphics and Production teams will be able to help collate the artwork required and produce a finished aluminium composite product that will last the site duration.

Stackboards consist of:

- Aluminium composite signs – various sizes, but normally in the format in the diagram below right
- Posts – Generally 5m, but other lengths available
- Channel – to affix the dibond signs to the posts
- Clips – to secure the signs to the channel



Printed site hoardings have effectively been the domain of the corporate construction company, but have been increasingly more accessible to all construction companies.

Our Graphics team has a wealth of knowledge and experience with construction projects, being able to ensure that all artwork is co-ordinated. Hoarding panels are manufactured to the highest standard in our UK factory

All of the hoarding panels are produced in 8ft x 4ft (2440mm x 1220mm) aluminium composite material to ensure lasting quality finish.

Pricing and lead times vary depending on design and individual requirements. We offer an installation service if required.

Please contact us on 01737 774 741 for a no obligation quote.



Pricing and lead times vary depending on individual requirements. We offer an installation service if required.

Please call us on 01737 774 741 for a no obligation quote.

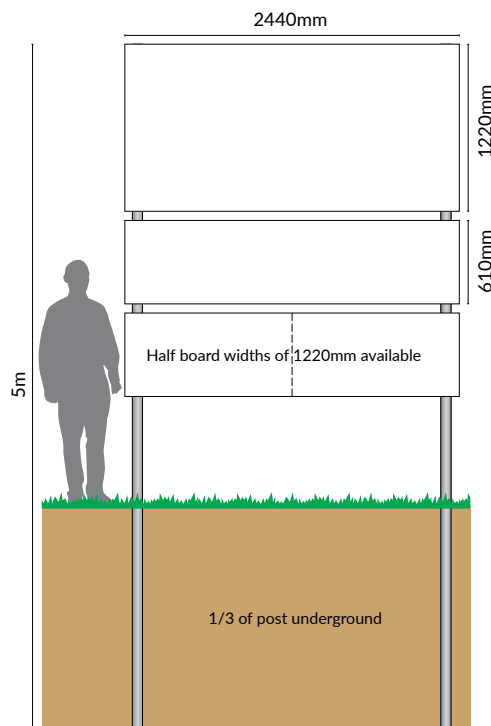
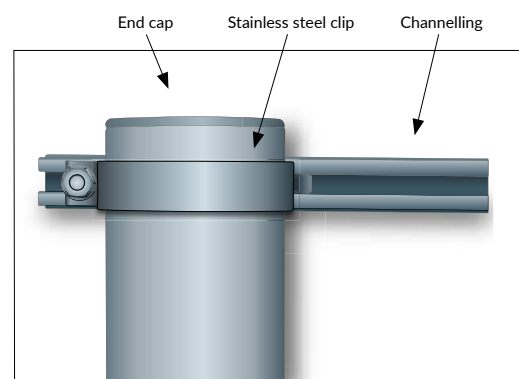



Construction site banners are an easy and effective way to advertise any build. As well as improving the external site aesthetics, banners can also be used to communicate important health and safety messages to both your staff and the public.

Whether banners are needed for internal site wayfinding or to fully cover construction site fencing, these durable banners are available in an unlimited range of sizes.

Banner options available;

Material: • 340gsm Mesh Banner • 440gsm Solid Banner • 710gsm Double Sided

Fixing: • Eyelets • Pole Pockets

Delivery time is 5-7 working days.

Below is a selection of our standard banners which can be modified to fit your requirements.



We can also 'custom make' any design and size to suit your needs, see examples below.



Advertise your company with name-boards on site entrances, hoardings and perimeter fencing.

Choose from our simple layouts or create your own custom designs.

If you do **not have** your company logo as a high-resolution bitmap (PDF/ jpeg format) or a vector graphic (eps/ai format) then we can help with this – for a small artwork charge of £20 we can redraw your logo, allowing a high quality print on all your signs.

For more information please call 01737 774 741



YOUR LOGO HERE

*Phone number here
Website here*

EE80176 600 x 400mm £18.67
EE80177 800 x 600mm £27.43

YOUR LOGO HERE

EE80174 600 x 400mm £15.56
EE80175 800 x 600mm £22.86



“Very good company, makes ordering signage very easy, quick delivery/turnaround and more importantly they price competitively. Free company logo on each sign also looks very professional on site.
Alan O’Grady, Buyer (J.Coffey)”

For extra large corporate boards please see the grid below

Code	Size in 10mm Correx	Price
EE80178	1220 x 400mm	£23.24
EE80179	1220 x 800mm	£46.48
EE80180	1220 x 1220mm	£71.00
EE80181	2440 x 1220mm	£142.00



Enviro Signs, a range of environmentally friendly sign alternatives for the conscientious contractor. We now offer all signs in two eco-materials; FSC certified display board and non PVC bubble board, both of which are 100% recyclable.

Non PVC Bubble Board

The Enviro Signs bubble board is sturdy, rigid with a smooth print finish and excellent display appearance. Being 100% recyclable the bubble board offers a hard-wearing temporary signage alternative to conventional plastic and foam boards.



Recyclable display boards & hoarding

Key Features

- Environmentally friendly Non PVC Product - 100% Recyclable
- Lightweight and water resistant
- Smooth print surface and excellent fabrication properties (Routable and Foldable)
- White Centred Finish with UV additive to improve exterior performance
- Guarantees 36 month lifespan when used outdoors with a board thickness of 3mm
- Maximum standard panel size - 1220 x 2440mm



For more information on the Enviro Signs Range please contact our sales team on 01737 774 077

Terms and conditions

- Please supply a high quality jpeg/PDF or an eps/ai file of your logo at time of first order to avoid delay in delivery.
- We will accept your order even if you have not ordered from us before. Our sales staff will be pleased to help in your enquiry and will process your order by the quickest possible method. By placing an order with us, you accept our terms of business.
- If the situation arises where your terms of business conflict with ours, our terms will prevail.
- Orders are dispatched complete whenever possible. In the event of shortages, part shipment will be made unless otherwise instructed from customer.
- We make no guarantee that our goods will conform exactly to their descriptions and illustrations. We have a policy of continual improvement and this may lead to amendments and deletions of our products from the catalogue. We reserve the right to make these changes if and when they may occur.
- We make every effort to ensure that the information we supply is correct.
- Although every effort will be made to maintain the prices stated in the catalogue, they are subject to change without notice.
- We supply our goods strictly on a 'retention of title' basis. Title will not be passed until the goods supplied have been paid for in full with cleared funds.
- We do not operate settlement discounts, all quoted prices are net.
- All of our products are subject to VAT.
- Settlement Terms are strictly 30 days from invoice date.
- Claims will only be entertained if we are advised in writing within seven days from the date of delivery or collection.
- Non standard signs that are supplied correctly may not be returned for credit.
- No part of our catalogue, literature or web site may be copied, stored on any type of retrieval system, or be reproduced.



The Stocksigns Group has over 60 years experience in the signage industry.

When choosing to buy from Stocksigns you can be assured you are purchasing a high quality product complying to the latest UK legislation.



Market leading supplier of quality LED signs and displays.



- ▶ Digital Accident Boards
- ▶ Trailer Mounted Messaging
- ▶ Traffic & Speed Awareness
- ▶ Single & Multi-line Messaging
- ▶ Mobile BMS
- ▶ Production Displays



call: 01737 774738

email: sales@messagemaker.co.uk

visit: messagemaker.co.uk





43 Ormside Way, Redhill, Surrey, RH1 2LG

Call: 01737 774 077

Email: sales@stocksigns.co.uk

Visit: www.stocksigns.co.uk