

# Locker Range

## Personal Storage Solutions

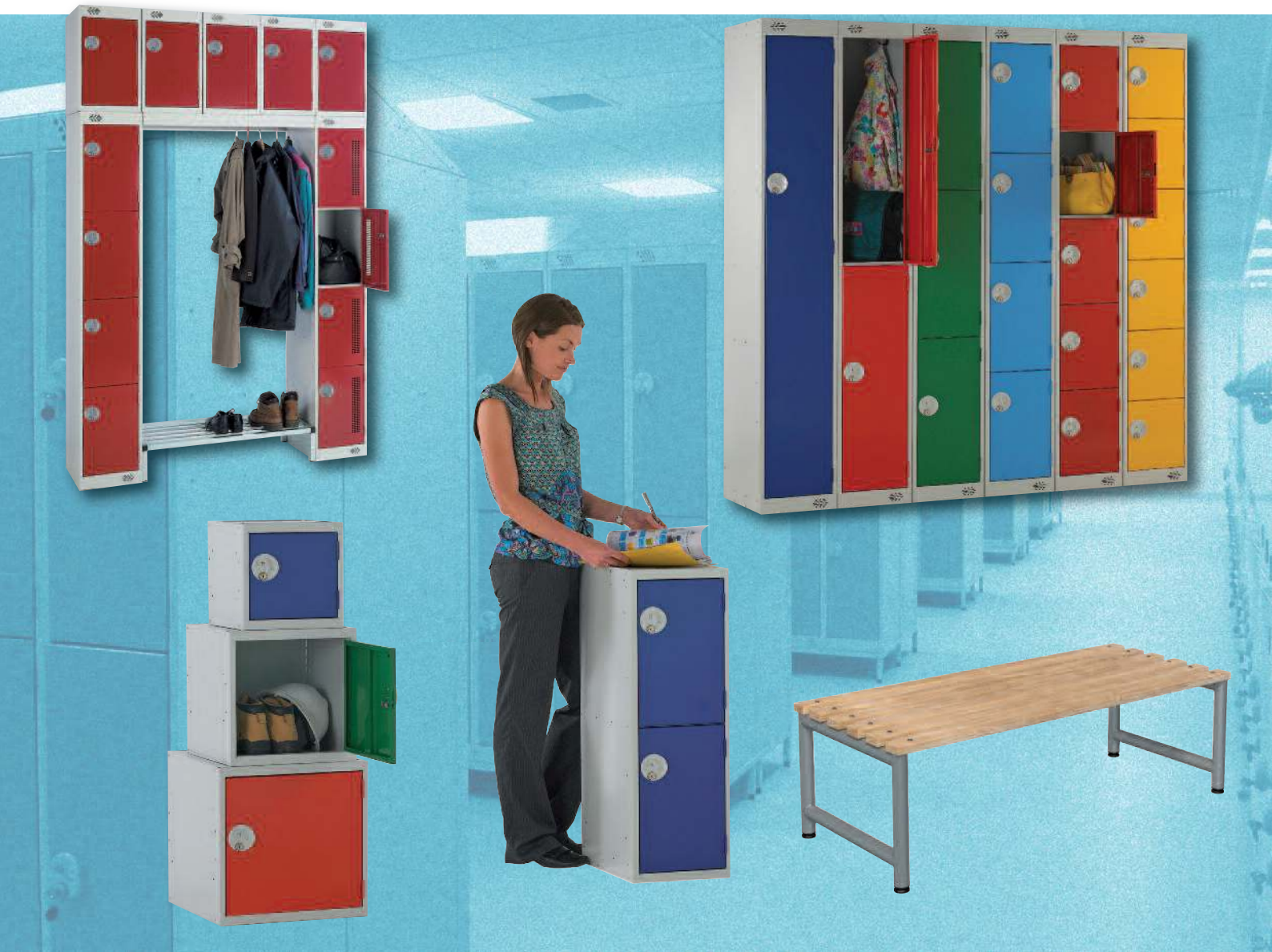

**LINK51**  
TRADE

## Contents

- 3 Locker Features
- 4 Accessories
- 5 Locker Room Design
- 6 Full height lockers
  - Colour Options
  - Door Options
- 8 Three-quarter height lockers
  - Half height lockers
  - Lock Options
  - Quarto lockers
  - Sixto lockers
  - Cube lockers
- 10 Utility Lockers
  - Crew Lockers
- 12 Medium Duty Lockers
- 13 Heavy Duty Lockers
- 14 Garment Dispensers
- 15 Laptop Lockers
  - Personal Item Lockers
  - Post Lockers
- 16 Laminate Door Lockers
- 17 Wooden Door Lockers
- 18 Seating and Benching
- 19 Plastic Lockers

# Delivering the right solution for you

**Our lockers and cupboards are designed and manufactured to a high specification to meet any personal storage requirements.**

They are built for a long efficient working life in factories, hospitals, schools, colleges, retail outlets - in fact anywhere needing tough, reliable and aesthetic storage. Their modular design makes these lockers and cupboards extremely adaptable and cost effective. Units can be specified from a wide range with a choice of locks, doors, colours and accessories, allowing lockers and cupboards to be tailored to a customers precise needs.

Our experience and expertise has enabled us to put together a proven product range, designed to conform to BS 4680 standards and manufactured in the UK to internationally recognised quality and environmental ISO standards. This reflects our commitment to producing the best products whilst reducing environmental impact in the design and manufacturing process.

### Free site visit and design

We will gladly come and discuss your requirements and help you plan your locker or cupboard needs. We will survey the room or area and produce a layout for your approval. Installation, if required, is undertaken by our appointed fitters, who ensure your job is installed to your satisfaction with the minimum of disruption and mess.



# Proven Products



## Robust Design

- All doors have an all-round reinforcing edge, spot-welded at each corner to enhance strength and rigidity.
- A welded vertical channel section stiffens the door for protection against impact damage.
- Steel three-knuckle hinges are welded to the door and riveted to the frame to give added strength and allow for easy replacement of damaged doors.
- Complying with BS 4680, a close fit between the door and the frame of less than 2mm protects against leverage in attempted forced entry.
- Colours are applied electro-statically as an epoxy-polyester powder coat, then baked to provide a high quality, durable finish.



## Integral Security

### Locking

- Features in-frame locking through the door with a hooked cam engaging into the frame.
- This provides extra security by significantly increasing resistance to forced entry.



### Anti-theft shelf

- The design of the intermediate shelf prevents access to compartments above and below an open door.



### Lock plate

- The lock cover plate and handle provides recesses to accept compartment numbering or identification.



## BS 4680 - the standard for clothes lockers



Our standard duty lockers have been tested and conform to the requirements of the British Standard for Clothes Lockers BS 4680: 1996 'Standard Duty'.

## Bacteria locked out

- Antimicrobial technology is incorporated into all lockers and cupboards at the time of manufacture, offering constant protection against a wide range of bacteria.





# Accessories for tailored solutions



## Sloping Tops for lockers

Sloping tops are essential in hygiene-sensitive locations such as hospitals and the food industry. The 22 degree slope prevents litter being left on locker tops and makes cleaning easier.

Dimensions mm	
Locker Depth	Top Height
300	125
380	158
450	187
500	207
550	228
600	240

## Support Frame with seat

Seat units are incorporated into the locker frame as well as slatted seats to the front. They can include a mesh shelf for footwear. Standard height is 400mm to match freestanding bench seating units.

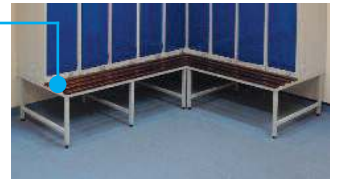

## Bridge Unit for Modular Lockers

### Bridge Unit Top

This is fitted to adjacent lockers with nuts & bolts supplied. Incorporates a central full-length hanging rail with the option of 'captive' clothes hangers which cannot be removed, thereby preventing theft and accidental loss.

Height - 60mm	
Widths mm	Depths mm
600	300
900	450
1200	500
	550

### Bridge Unit Base

A free-standing rack to support footwear or other items 150mm above the floor.



## Support Frame

Locker support frames and seat units raise lockers off the floor, reducing impact damage and making cleaning easier. Support frames are manufactured from 25mm square steel tube in a welded construction and are painted light grey as standard to match the lockers. Standard height is 150mm, and widths and depths are designed to match the locker installation.



# Locker Room Design

## Features of the locker room

The size, location, fixtures & fittings of the area or room designated for the lockers will affect the positioning and layout of the lockers. Take into account the following:

- Is the room or area large enough to accommodate the number (and size) of lockers required, whilst still leaving enough space for users to have easy access?

*Note:* ensure that the space is not confined, making the lockers awkward or uncomfortable to use, and the room potentially hazardous in an emergency evacuation situation (in response to a fire alarm, for example).

- Is the room or area accessible to groups of people who may all arrive at one time? Are any adjacent corridors, stairs or lifts easy to get to and move through? Is the room readily accessible for delivery and installation of the lockers?
- Take into account the position of doors and windows and their effect on the locker layout.

*Note:* the position of fixtures and fittings which could either obstruct the lockers or be obstructed by them. For example: ceiling pillars, low ceilings, alcoves, beams, skirting boards, radiators & heating pipes, light switches, sockets and other power outlets, lighting fixtures, ventilators and air-conditioning units, any access to service points.

- Check the condition of the floor - What is it made of? Is the surface suitable and in good condition? Is it level: lockers should always be located on a level, even floor. If there is significant slope, consider locating the lockers on support frames with adjustable feet.
- How are the floors cleaned? Even in a generally 'dry' changing area, the floor may be washed or mopped down from time to time. Where floors may be left damp for some time and on a regular basis, consider raising the lockers from the floor on a support frame which has a protective finish against corrosion.
- Assess the lighting - ill-lit locker rooms can appear oppressive and unwelcoming. Carefully assess the positioning of lockers and their effect on lighting - avoid creating areas of dark or shadow in the room, particularly in corners. If there is natural light, make the best use of it. How is the artificial light provided? Will it conflict with the locker layout? If so, can the lighting be altered or the locker layout changed?

## Locker Run Spacing

Lockers standing on the floor should be positioned so that there is a clear space or aisle at least 900mm wide - but preferably 1000mm - between the locker fronts and the opposing fixture - this could be a parallel run of lockers, or a corridor wall. Always allow clearance for wide-open doors - this varies according to the locker width.

Where space is available, the width of the aisle can be increased up to 1500mm where facing lockers are likely to be used simultaneously.

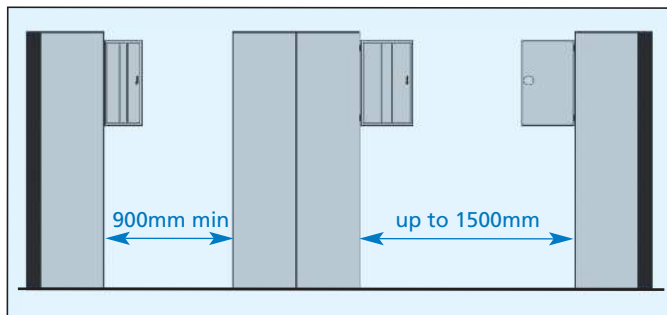

Lockers standing on support frames fitted with a seat should have a minimum aisle width of 900-1000mm between seats, but a spacing of 1200mm is desirable if facing lockers are to be used simultaneously.

## Requirements for usage

**Consider the following at the initial planning stage:**

- How many people in all have a requirement for a locker?
- Do people require their own personal locker or can the lockers be shared? - for example, to cater for shift workers
- When will the lockers be used? - are they required on a regular daily basis, or infrequently?
- Accessibility: what would be the maximum number of people requiring access to the lockers at any one time? - is additional space required to prevent overcrowding at 'peak times' - during the changeover of work shifts, for example
- What kinds of items of clothing, equipment, personal possessions or carrying bags will users bring into the locker room? This will help determine the size of compartment/s required and also the locker and floor spacing - for example, where bulky clothing or equipment is involved, more floor space may be necessary for ease of movement
- What kind of access and 'ownership' is required for the lockers? This will influence the type of lock used: where an individual has their own locker, a cam-lock or padlock can be fitted, operated by the owner's key; where lockers are for shared use, coin or token-operated locks may be preferred as easier to administer
- What degree of privacy is appropriate? - people may need to change their clothes, in part or in full
- Is there a requirement for seating?
- Is there a requirement for 'shared' clothes hanging facilities within the locker room?

## Locker Nesting

Lockers are supplied as nested units - lockers of the same overall dimensions, sharing common side panels, manufactured and supplied fitted together.

This saves on the steel used, giving you the most economical solution.



Initial locker  
Nest of 1

Nest of 2 lockers

Nest of 3 lockers

## Overall Dimensions

When planning a locker room layout, allowance should also be made for the incremental increase in the overall length of locker runs, where nested units are butted together.

2mm is added to the overall length at each point where two nested units join together (refer to example illustrated, below).

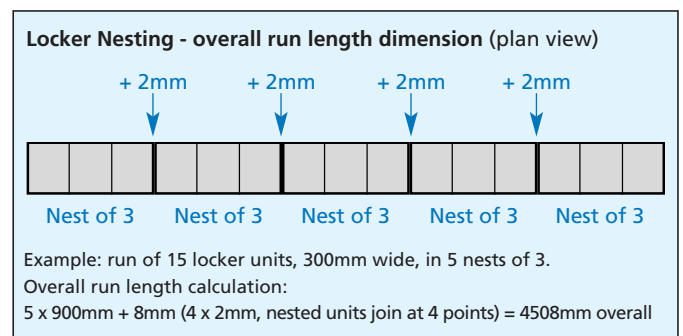

# Colours and Finishes

## Paint Finish

Epoxy-polyester powder coat colours.

**Standard Body colour is Light Grey (RAL 7035)**

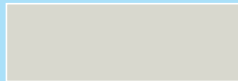

Light Grey (RAL 7035)

## Standard Door Colours

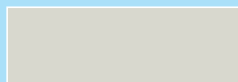

Light Grey (RAL 7035)



Red (RAL 3020)

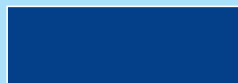

Blue (RAL 5002)



Green (RAL 6001)



Carmine Red (RAL 3002)



Yellow (RAL 1003)

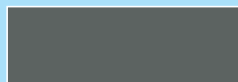

Dark Grey (BS 00A11)

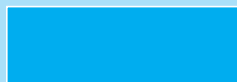

Electric Blue (BS 20 E 51)

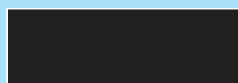

Black (RAL 9005)

## Pastel Door Colours



Sunburst Yellow (BS 10 E 50)



Candy Pink (BS 02 C33)



Light Violet (BS 381 C 797)



Turquoise (RAL 6034)

*Note: due to the limitations of matching painted steel to the printing process, colours illustrated on this page offer a good, but approximate guide. For exact colour reference, painted steel samples are available upon request.*

# Mild Steel Modular

## Full Height



### Single-Door

#### Internal fittings:

- Fixed top shelf.
- Fixed garment hanging rail (except for 300mm deep).
- Two coat hooks.

Height - 1800mm	
Widths mm	Depths mm
225	300
300	380
380	450
450	500
	550
	600



### Two-Door

#### Internal fittings:

- One intermediate fixed shelf.
- Each compartment has a fixed garment hanging rail (except for 300mm deep).
- Each compartment has two coat hooks.

Height - 1800mm	
Widths mm	Depths mm
225	300
300	380
380	450
450	500
	550
	600

## Door Options

You can choose from a variety of door styles to tailor the locker to your specific situation.



### Standard Duty Door

This flat mild steel door fits flush within the door frame – less than 2mm between door and frame (for compliance with BS 4680) to protect against leverage in attempted forced entry.



### Perforated Door

Particularly useful where damp clothes and odours pose a problem.



### Vision Door

Incorporates a toughened polycarbonate view panel set within a steel door with an all-round strengthened edge - allows you to see items stored in locker compartments without compromising security.

# lockers for maximum versatility



### Three-Door

**Internal fittings:**  
 ● Two intermediate fixed shelves.

Height - 1800mm	
Widths mm	Depths mm
225	300
300	380
380	450
450	500
	550
	600



### Four-Door

**Internal fittings:**  
 ● Three intermediate fixed shelves.

Height - 1800mm	
Widths mm	Depths mm
225	300
300	380
380	450
450	500
	550
	600



### Five-Door

**Internal fittings:**  
 ● Four intermediate fixed shelves.

Height - 1800mm	
Widths mm	Depths mm
225	300
380	380
450	450
	500



### Six-Door

**Internal fittings:**  
 ● Five intermediate fixed shelves.

Height - 1800mm	
Widths mm	Depths mm
225	300
300	380
380	450
450	500
	550
	600



**Insight Door**  
 These shatter proof polycarbonate doors allow 100% visibility while maintaining the highest level of security.



Full height lockers with Sixto lockers for additional under-seat storage.

Quarto and Sixto lockers can be fitted on top of lockers to increase available storage height with additional compartments.



Cube lockers are ideal for stacking, creating banks of individual compartments.



# Mild Steel Lockers for maximum versatility

## Three Quarter Height

## Half Height



### Single-Door

**Internal fittings:**

- Compartment has a fixed garment hanging rail with two coat hooks.

Height - 1382mm	
Widths mm	Depths mm
225	300
300	380
380	450
450	500
	550
	600



### Three-Door

**Internal fittings:**

- Two intermediate fixed shelves.

Height - 1382mm	
Widths mm	Depths mm
225	300
300	380
380	450
450	500
	550
	600



### Single-Door

**Internal fittings:**

- Compartment has a fixed garment hanging rail with two coat hooks.

Height - 900mm	
Widths mm	Depths mm
225	300
300	380
380	450
450	500
	550
	600



### Two-Door

**Internal fittings:**

- One intermediate fixed shelf.

Height - 900mm	
Widths mm	Depths mm
225	300
300	380
380	450
450	500
	550
	600

## Lock Options



### Standard Deadlock

This simple and economical cam lock provides user access with a small, easily replaced key. The lock is supplied with two keys and a master key is available.



### Coin/Token Return Lock

Ideal when lockers have 'shared' users. The key is released when coin (£/€) or token is inserted. Key is captive again when the door is reopened and the coin/token is returned to the user.



### Hasp & Staple Padlock Fitting

Transfers responsibility for locking to the user. The user is required to secure the locker with a padlock (not supplied). This system provides flexibility at the loss of some control over allocation of lockers.



### Coin/Token Retain Lock

Generates revenue from 'shared' user lockers. The key is released when coin (£/€) or token is inserted. Key is captive again when the door is reopened. Coin/token is retained in the box.



# Small Modular lockers

## Quarto

## Sixto

## Cube



### Three-Door

#### Internal fittings:

- Two intermediate fixed shelves.



Quarto and Sixto lockers can be stacked, their modular design also allowing them to be used with standard lockers



Cubes - as the name suggests - have an equal height, width and depth allowing combined stacking of units on the floor or on support frames.

Height - 900mm	
Widths mm	Depths mm
225	300
300	380
380	450
450	500
	550
	600

Height - 511mm	
Widths mm	Depths mm
225	300
300	380
380	450
450	500
	550

Height - 372mm	
Widths mm	Depths mm
225	300
300	380
380	450
450	500
	550

Heights - 300, 380 or 450mm	
Widths mm	Depths mm
300	300
380	380
450	450



#### Multi-user Combination Lock

Ideal for facilities where keys are not desirable. The lock can be reset whenever it is open. This allows the locker to be used by several people at different times throughout the day, reducing the number of locker compartments required and the need for keys.



#### Magnetic Catch Lock

For use in Primary schools or environments where risk of key loss is high and security minimal. Offers positive closure of the door.



#### Digital Combination Lock

Simple-to-use, battery-operated keyless lock. Can be programmed for dedicated single-user or multi-user 'open access' mode. Personal entry code can be set and changed, whilst a master key ensures supervisor access.

# Utility Lockers

## Utility



### Uniform Locker

**Internal fittings:**

- Fixed top shelf.
- Central divider.
- Hanging rail and hook.
- Three fixed shelves.

Height - 1800mm	
Width mm	Depth mm
450	450



### Clean & Dirty Locker

**Internal fittings:**

- Fixed top shelf.
- Central divider.
- Both divided compartments have a garment hanging rail and coat hook.

Height - 1800mm	
Width mm	Depth mm
450	450



### Two Person Locker

**Internal fittings:**

- Users have a three quarter length compartment with a separate full width compartment opened with the same key.
- Hanging compartment has two coat hooks.

Height - 1800mm	
Width mm	Depth mm
450	450

- Also available sloping tops, see page 4.
- Choice of door colours, see page 6.
- Fitted with Deadlock as standard. Optional locks, see page 8 for details.



## Police

We also offer a variety of Police locker solutions. From the storage of 'Airwave' radios to PSU bags we have the right solution for Police forces throughout the UK.

Height - 1800mm	
Width mm	Depth mm
450	600
600	600

## Crew



### Work Wear Locker

**Internal fittings:**

- Top shelf, divided compartment below, with one fixed shelf and hanging rail to either side.

Height - 1800mm	
Width mm	Depth mm
380	450



### Two compartment

**Internal fittings:**

- Fixed heavy-duty top shelf.
- The hanging compartment has a heavy duty hanging rail.

Height - 1800mm	
Width mm	Depth mm
450	600
600	600



### Four compartment

**Internal fittings:**

- Fixed heavy duty top and lower shelves.
- Divided compartments.
- Heavy duty hanging rail.

Height - 1800mm	
Width mm	Depth mm
600	600



### Police Locker with:

- Lockable cube on door with clear perspex front



### Police Locker with:

- Airwaves compartment
- CS Cannister holder



### Police Locker with:

- CS Cannister holder





# Medium Duty Lockers

The medium duty design raises the standard duty ranges to a higher level of protection.

Enhancing the already robust design of the Standard Duty steel locker, the uprated medium duty versions have an additional vertical reinforcement channel and a shielded front of double-gauge steel for triple thickness protection.

This toughened design provides additional defence against the twin problems of vandalism and theft.

- Second channel section welded to the inside of the door to provide triple thickness strength.
- This significantly increases the reinforced area of the door's width and height and makes the door extremely difficult to deform, providing additional protection against forced entry.
- The form of the of the channel is extended across both sides of the door it doubles the gauge of the steel to resist impact damage.
- Also available sloping tops, see page 4.
- Choice of door colours, see page 6.
- Fitted with Deadlock as standard. Optional locks, see page 8 for details.



Height - 1800mm	
Widths mm	Depths mm
300	300
380	380
450	450
	500
	550
	600

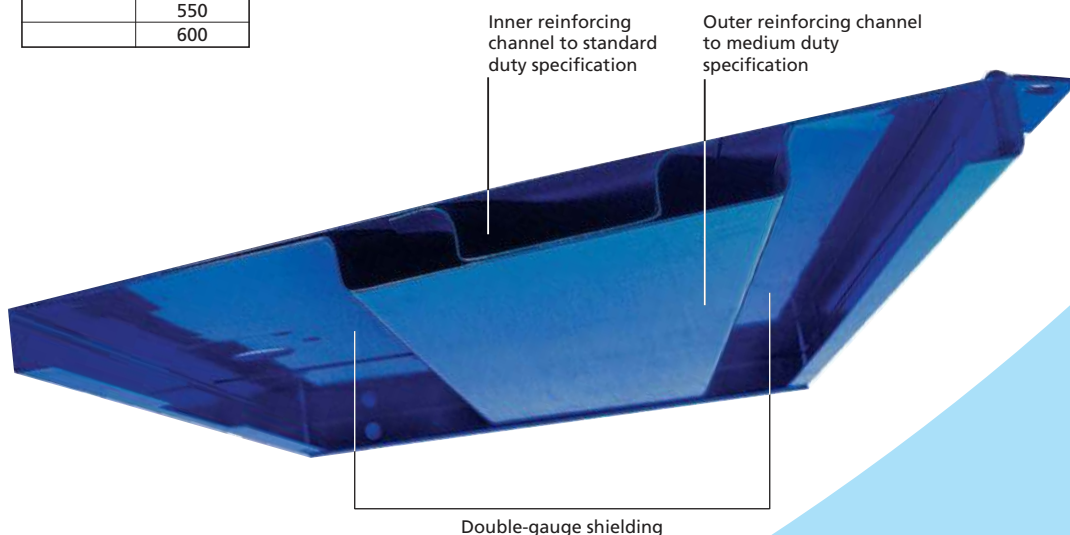

# Heavy Duty Lockers

Combining robust design with a heavy gauge 'double skin' door to guard against leverage and impact, heavy duty lockers are hard to beat when it comes to long-lasting security.

- Heavy-duty 5-knuckle hinge welded to the door, but riveted to the frame to allow for easy replacement.
  - Single compartment lockers, fitted with hat shelf and hanging rail with double coat hook as standard.
  - Two compartment lockers have double coat hook in each compartment.
  - Choice of door colours, see page 6.
  - Fitted with Deadlock as standard.
- Optional locks.  
 Hasp & staple fitting (for use with own padlock).  
 Coin/token operated locks.  
 See page 8 for details.

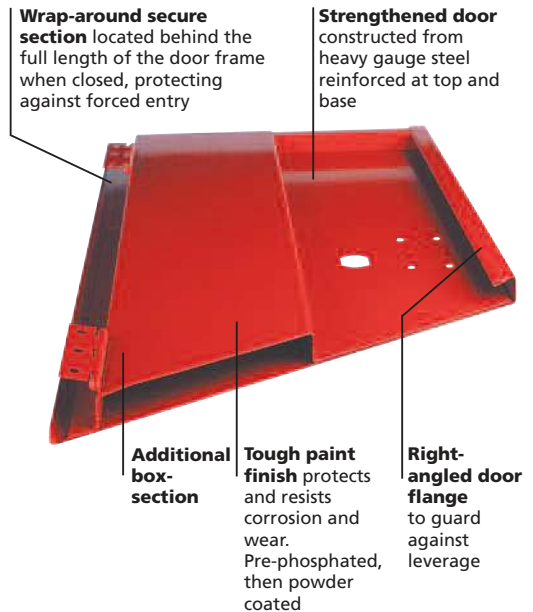

Two Door



Three Door



Four Door



Six Door

Height - 1778mm	
Width mm	Depths mm
305	305
	457

Single Door

# Garment Dispensers and Collectors

The managed issue of workplace clothing - often via third party laundries - is an essential part of hygiene procedure in many sectors. Integral anti-bacterial protection (see page 3) on all our garment issue lockers provides a valuable additional benefit to these industries.

- Also available sloping tops, see page 4.
- Choice of door colours, see page 6.
- Fitted with Deadlock, with 2 keys.



Designed initially for work wear, these lockers are equally suitable for the controlled issue of safety equipment, consumables or specific materials required for a working day or shift.

### Individual Access

Garment issue lockers provide each worker with key access to their secure compartment to collect a freshly laundered issue of clothing. Compartment doors are inset within the main full-height door, which remains locked.

### Convenient Re-supply

The full-height main door allows access to all of the individual compartments for re-stocking with laundered clothing.

### Laundry Collection

Workers 'post' their used garments into an adjacent Collection locker. These are collected in a laundry bag (not supplied with lockers). This separation of clean and used items can make a major contribution to maintaining a hygienic working environment.



Height - 1778mm	
Width mm	Depth mm
381	457

**10-Door Dispenser**  
**15-Door Dispenser**

### Collector

- Full-height door.
- Galvanised anti-theft shelf, angled inside 'post slot'.
- Hooks for laundry collection sack (sack not included).



**5-Door Dispenser**



**20-Door Dispenser**

### 5-Door Collector & Dispenser

- Half-height upper 'issue' door with 5 compartments.
- Lower 'collector' door with 'post slot'.
- Hooks for laundry collection sack (sack not included).





# Laptop Lockers

These purpose-designed locker units provide a safe sanctuary for laptops and real peace of mind for users.

- 15 compartment locker has each door reinforced fitted with its own key-operated cam lock ('dead locking').
  - Single door locker version allows access to all compartments under one key.
  - 15 compartment lockers accept laptops WITHOUT carry cases.
  - Laptop lockers are available with optional hardwiring for power and networking, allowing computers to be recharged while being stored.
  - Also available sloping tops, see page 4.
  - Choice of door colours, see page 6.
  - Fitted with Deadlock as standard.
- Optional locks.
- Hasp & staple fitting (for use with own padlock)
  - Digital combination lock (4 door only).
  - Coin return lock (4 door only).
- See page 8 for details.



**Single-Door Locker**

Compartment size  
● 90h x 285w x 425d mm

Height - 1778mm	
Width mm	Depth mm
381	457



**Fifteen-Door Locker**

Compartment size  
● 90h x 285w x 425d mm

Height - 1778mm	
Width mm	Depth mm
381	457

# Personal Item Lockers

Personal item lockers provide secure storage for small but valuable possessions in public areas and throughout the working environment.

- Choose from 4 or 8 doors in nests of 1 or 2.
  - Units can be hung on walls, fitted on top of each other or side to side.
  - Choice of door colours, see page 6.
  - Fitted with Deadlock as standard.
- Optional locks.

Hasp & staple fitting (for use with own padlock).  
Digital combination lock (4 door only).  
Coin return lock (4 door only).  
See page 8 for details.



Height - 915mm*	
Width mm	Depth mm
250	155

\*Height rises to 975mm with sloping top.



Perforated Door



Plain Door

# Post Lockers

- Allows sorted mail to be posted into secure compartments which are opened on the recipients key.
- 10 or 15 tier lockers.
- Individual doors are set within a main door, which is opened on its own key giving access to all of the interior.
- Choice of door colours, see page 5.
- Fitted with Deadlock, with 2 keys.



Height - 1800mm	
Width mm	Depth mm
381	457

# Laminate Door Lockers

Combines the versatility of steel lockers with the durability of solid grade laminate doors.

- Solid grade laminate material offers a robust, elegant solution with a range of colours and material designs, to satisfy all requirements.
- Plant-on doors cover the front face of the locker carcass creating a wall of colour.
- 180° hinge offers unparalleled levels of access to each compartment making full use of clear entry.
- Fitted with Deadlock.



## Standard Solid 10mm Grade Laminate



Single and two tier doors subject to minimum quantity.

### Door Finish

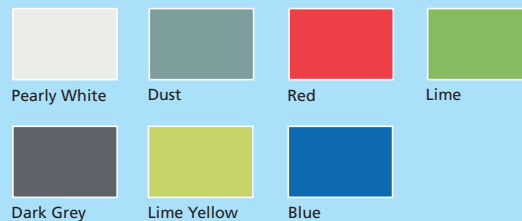

Height - 1780mm	
Widths mm	Depths mm
305	390
	470



Available in 1, 2, 3 and 4 doors.

# MDF Wood Laminate Door Lockers

Lockers combine the strength and durability of steel lockers with the aesthetic appearance of wooden lockers.

Economical alternative to all wooden facilities, providing a clean, professional finished line presenting an all wood front. Matching end panels ensure the finished installation has a quality 'all wood' effect.

- Easy access hinges open through a wide 164° for ease of access.
- Durable 10mm MDF timber effect with 2mm pvc edging.
- Fitted with Deadlock as standard. Optional lock range available - ask for details.
- Optional end panels available.



Numbering system available at additional cost. Number plates will be recessed into door if ordered with lockers.

## 10mm MDF Wood Effect Finish

Due to printing restrictions colours represented may differ from original product.



Ash



Beech



Maple



Oak



Height - 1780mm	
Widths mm	Depths mm
305	315
380	390
	470



# Seating & Benching

Hook Bench and Benches are available with 3 seat heights making them the perfect solution for schools, whatever age group they teach.



**Ash Solid Timber Slats**  
Sourced from sustainable forests.



**Black Polymer Slats**  
Manufactured with Active-Coat additive, these food grade slats are also ideal for educational or leisure wet area changing areas.

Choice of frame colours .....  
all with ActiveCoat  
anti-bacterial protection



50mm diameter welded  
tube frames for strength  
and durability

Adjustable feet are fitted .....  
to all floor standing units

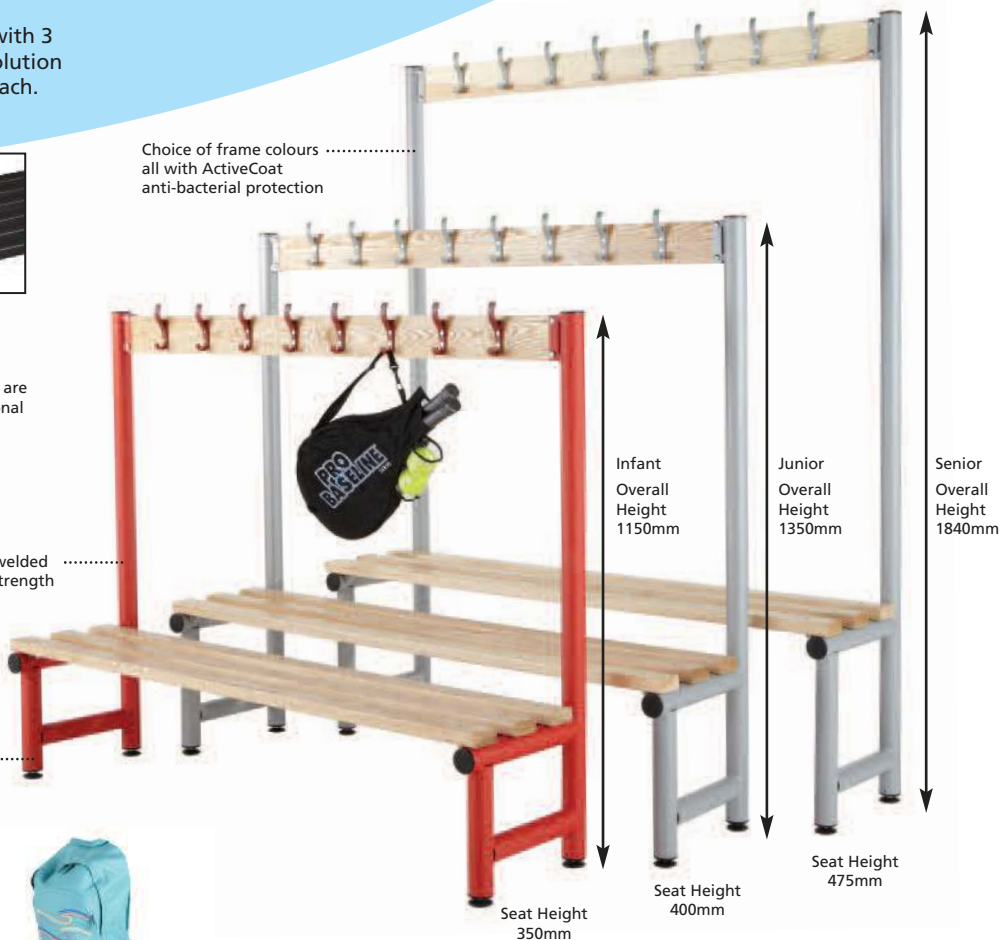

## Frame Colours



## HOOK BENCHES

A single and double sided hook bench with 5, 8, 10, 16 or 20 hooks. Available in five frame colours.

Three overall height sizes; Senior - 1840mm, Junior - 1350mm and Infant - 1150mm with three bench heights 475mm, 400mm and 350mm respectively

- Light Ash or Black Polymer slats
- 50mm welded tubular frame



Light Ash slats on Silver, White and Black frames will be supplied with black hooks unless otherwise specified. Red and blue frames will have matching hook colour.



Black Polymer hook benches are fitted with grey hooks unless stated otherwise.



Double sided  
Black Polymer  
1500mm wide  
hook bench



Single sided Black  
Polymer 1500mm wide  
hook bench



Single sided Light Ash  
2000mm wide hook bench



Double sided Light Ash 2000mm wide  
hook bench

**BENCHES**

Single and double sided modern cloakroom benches with 5 frame colour options to suit any cloakroom.

Three overall height sizes; Senior - 1840mm, Junior - 1350mm and Infant - 1150mm with three bench heights 475mm, 400mm and 350mm respectively

- Light Ash or Black Polymer slats
- 50mm welded tubular frame



Single sided Black Polymer 1500mm wide bench



Double sided Light Ash 2000mm wide bench



Double sided Light Ash 1500mm wide bench



Single sided Black Polymer 2000mm wide bench

**OVERHEAD HANGING BENCHES**

Single and Double Sided Overhead Hanging Benches have an overall height of 1840mm and a bench height of 475mm.

- Light Ash or Black Polymer slats
- Anti-theft coat hangers
- 50mm welded tubular frame



Single sided Light Ash 2000mm wide overhead hanging bench



Double sided Black Polymer 1500mm wide overhead hanging bench

Our range of seating and benching also includes a range of cantilever units, seat & stands and seat units all of which can be used to enhance the changing room experience.



**Locker Seat & Stand**  
Two hardwood slats and metal framework form a bench seat in front of the locker, allowing full height access. Complete with adjustable feet



Wall Mounted Cantilever Seating



**Wall Hook Strip**  
Cloakroom bench accessories. Wall fixings NOT included. Black Polymer strips are fitted with grey hooks unless stated otherwise



**Low Seats**  
Single or Double sided



Wall Mounted Shelf & Rail



**Shoe Baskets**  
Single silver grey robust shoe baskets - 305mm in height. Fixings NOT included. Can provide extra space by adding shoe baskets.

# Plastic Lockers



**Two-Door**

**Three-Door**

**Four-Door**

Height - 1800mm	
Widths mm	Depths mm
325	450

Weather proof polyethylene locker includes neoprene internal door seal and waterproof locks that can with stand water jets to IP55 rating.



**Two-Door Mini**



**Single-Door Mini**

Height - 900mm	
Widths mm	Depths mm
325	450

Height - 450mm	
Widths mm	Depths mm
325	450

A robust and rust proof polyethylene locker that makes it highly vandal resistant and ideal for wet area changing rooms and outdoor storage.

Often educational environments will use the half size locker and place a colourful wall of lockers on outdoor corridors meaning bags and books are quickly retrieved by pupils as the move to diferent classrooms. Also found in swimming pool areas where rust resistance is a key requirement.

Made of polyethylene with an antibacterial additive coating.

## Door Colours Colours



Blue



Grey



Red



Yellow



**LINK51**  
TRADE

For further information contact your local distributor