

**FloPlast**  
building the future

## Roofline, Window and Cladding Systems



[www.floplast.co.uk](http://www.floplast.co.uk)



## Introduction to FloPlasts Roofline, Window and Cladding Systems

**FloPlast**, a name synonymous with high quality PVC-UE roofline products for new build and home improvement projects, with its wide range of rainwater systems, cellular foam and rigid PVC-UE building profiles.

FloPlasts has rainwater Systems include **Half Round**, **Square Line** and **MiniFlo** and are complemented with the choice of three high capacity systems:-

**Hi-Cap**, a semi-elliptical profile with a high capacity suitable for large roof areas.

**Niagara Ogee**, a traditional ogee style profile - probably the highest capacity domestic PVC-U Rainwater System on the market.

**XtraFlo**, a 170mm semi-elliptical System, for large Commercial/Industrial buildings, which links to a 110mm downpipe system.

A comprehensive selection of co-extruded cellular foam and rigid PVC-UE building profiles completes the FloPlast range of Roofline products.

FloPlast Roofline, Window and Cladding extrusions are manufactured on state of the art machinery and extrusion dies at the group's Cork plant, which has over 40 years extrusion experience behind it.

For CE DOP's (Declaration of Performance), please refer to our website at [www.floplast.co.uk](http://www.floplast.co.uk).

FloPlast operations embrace quality, environment and energy management systems which have been accredited by BSI to  
BS EN ISO 9001:2015 Certificate No. FM 501414,  
BS EN ISO 14001:2015 Certificate No. EMS 538445,  
BS EN ISO 45001:2018 Certificate No. OHS 593622 and  
ISO 50001:2011 Certificate No. ENMS 638370.



Both the white roof trim and white cladding systems have been assessed and achieved Agrément Certification as follows:-



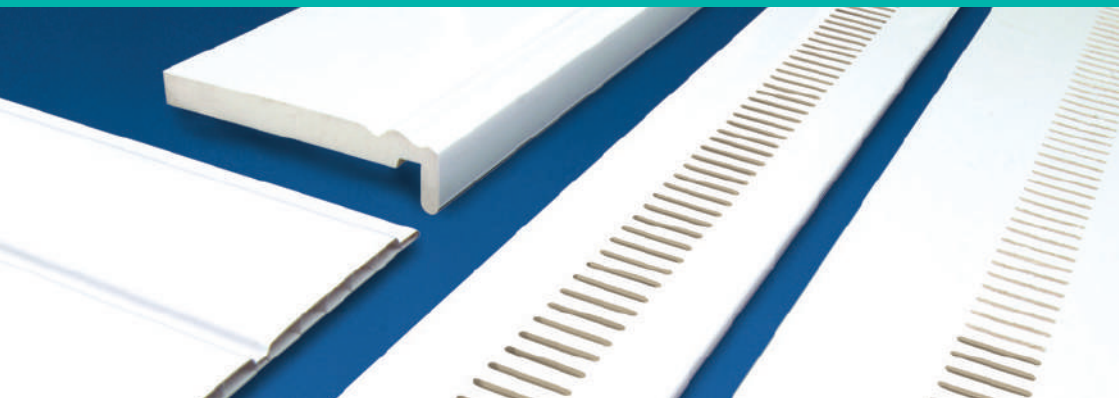

## Features and Guarantee

**Maintenance** - Will not rot, warp, crack or erode.

They do not require painting or any other protective treatment. To restore to an 'as new' surface appearance, occasional washing with a non-scratch mild detergent and water will remove surface grime particularly in polluted atmosphere.

**Weather resistance** - The impermeable outer skin and closed-cell composition of the boards are unaffected by moisture and will not rot or corrode.

**Durability** - The combined cellular core and Co-extruded PVC-U surface skin ensure high durability in all conditions.

**Thermal efficiency** - Good insulating properties, improves overall thermal insulation of composite wall construction.

**Compatibility** - No chemical reaction with other common building materials.

**Workable** - Cutting, drilling, nailing and shaping are easily achieved.

**Finish** - High gloss finish with blemish free surface.

**Guarantee** - FloPlast Co-extruded White Cellular and Woodgrain PVC-UE boards come with a 20 year product guarantee for white roofline and a 10 year product guarantee for laminate roofline in respect of performance and significant discolouration. The guarantee is subject to registration of the installation. Full details of the guarantee are available upon request.

**Behaviour in relation to fire:**

**Boards** - The cellular boards achieve a Class 2Y surface-spread-of-flame rating when tested in accordance with BS 476-7.

**Hollow Soffit** - The hollow soffits achieve a Class 1Y surface-spread-of-flame rating when tested in accordance with BS 476-7.

**Foiled Products** - The Renolit foil applied to FloPlast's cladding, boards or hollow soffit systems has been tested and achieved the following fire rating:

When tested in accordance with DIN4012-B2 and DIN EN ISO13501-1, the requirements according to RAL-GZ716/1 Section I Part 7 are fully met.

**General** - On exposure to fire, PVC-U tends to char and may fall away. The spread of flame along its surface is limited. It is unlikely that the roof trim system will significantly affect the overall fire performance of any roof in which it is installed.

Where it is normal practice to carry the eaves box over, between dwellings, it is important that the box is fire-stopped at compartment walls with a proprietary fire stop material.

For more information please refer to our BBA certificate 00/3771 and 00/3772.



## White PVC-UE Roofline Board

### Fascia, Soffit, Bargeboard and Trims

FloPlast offer a range of Fascia Boards for use in both new build work, total replacement or refurbishment by covering existing timber. The range of fascia profiles comprise:

- A traditional 9mm Universal Board which requires a backing board.
- An Ogee Fascia Board which offers an attractively designed alternative to the Universal Board.
- An 18mm Mammoth Board which does not require a backing board to support it, because of its rigid linear strength, and thickness. This makes it extremely suitable for total replacement and new build applications when it is fixed directly to the rafter ends.
- Ogee Mammoth Board which again offers the attractive alternative to the plain mammoth board.

A range of matching PVC-U mouldings caters for all joints and corners.

Soffits can be formed using a number of options:

- Multi-Purpose Board up to a width of 600mm combined with Soffit Vent Strip or Circular Disc Ventilators.
- Pre-vented Soffit Board with air slots to provide ventilation to a 10mm or 25mm wide clear air gap, which conform to current building regulations.
- Cladded Soffit using the 150mm Shiplap Cladding or 100mm V Joint Cladding to give an attractive ribbed effect.
- Rigid PVC-U Hollow Soffit in 300mm widths provide a cost competitive and effective alternative to cellular boards. These should not be used as an external cladding system.

Product	Size	Code
---------	------	------

### Universal Board - 9mm

Suitable as fascia (refurbishment - install over timber support), window board or reveal liner.

	Single Leg:	100mm	U100
		150mm	U150
		175mm	U175
		200mm	U200
		225mm	U225
		250mm	U250
	275mm	U275	
	300mm	U300	
Double Leg:		354mm	U350
		450mm	U450

### Square Edge Universal Board - 9mm

Suitable as fascia (refurbishment - install over timber support), window board or reveal liner.

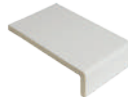
	Single Leg:	150mm	L150
		175mm	L175
		200mm	L200
		225mm	L225
		250mm	L250
Double Leg:	400mm	L400	

### Ogee Fascia Board - 10mm

Suitable as fascia (refurbishment - install over timber support).

	Single Leg:	150mm	O150
		175mm	O175
		200mm	O200
		225mm	O225
		250mm	O250
Double Leg:	404mm	O404	

Product	Size	Code
---------	------	------

### Box End Boards

Universal Board	454mm	UB454
Mammoth Board	404mm	MB404
Ogee Mammoth Board	454mm	GB454



## White PVC-UE Roofline Board, Soffit & Fixings

Product	Size	Code
---------	------	------

### Mammoth Board - 18mm

Suitable as fascia (replacement/new build install direct to rafters), window board or reveal liner.

Single Leg: 	150mm	M150
	175mm	M175
	200mm	M200
	225mm	M225
	250mm	M250
	300mm	M300
Double Leg:	404mm	M404

### Ogee Mammoth Board - 18mm

Suitable as fascia (replacement/new build, install direct to rafters).

Single Leg: 	150mm	G150
	175mm	G175
	200mm	G200
	225mm	G225
	250mm	G250
	300mm	G300
	Double Leg:	454mm

### Multi-Purpose Soffit Board - 10mm

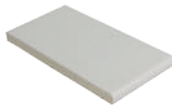
Single Round Edge: 	100mm	S100
	150mm	S150
	175mm	S175
	200mm	S200
	225mm	S225
	250mm	S250
	500mm	S500
Double Round Edge:	304mm	S304
	404mm	S404
	600mm	S600

### Hollow Soffit

To be used as a soffit only.

	300mm	H300
--	-------	------

Product	Size	Code
---------	------	------

### Hollow Soffit Trims

	'J'	HJ
	'H'	HH

### Vented Soffit - 10mm

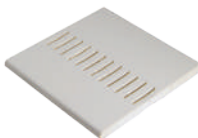
	100mm	V100
	150mm	V150
	175mm	V175
	200mm	V200
	225mm	V225
	250mm	V250
	304mm	V304
	404mm	V404
	600mm	V600

### Double Vented Soffit - 10mm

	175mm	DV175
	200mm	DV200
	250mm	DV250
	304mm	DV304
	404mm	DV404

Vented soffit with a double row of vents is available for special order.

### FloTop Pins

	30mm	FP30
	40mm	FP40

### FloTop Nails



	50mm	FN50
	65mm	FN65

### Clad Pins

	30mm	CP30
	50mm	CP50







## White Roofline Joints and Trims

Product	Size	Code
<b>In-Line Joints</b>		
	300x42mm Leg	RT1
	500x35mm Leg	RT2*
	500x42mm Leg	RT3*

\*Double ended joint - cut to 2 sizes as required. To be used with Mammoth Board.

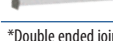

†Double ended joint - cut to 2 sizes as required. To be used with Universal Board.



Product	Size	Code
<b>Corner Joints</b>		
	300x42mm Leg	RT4
	500x35mm Leg	RT5*
	500x42mm Leg	RT6†
	300x42mm Leg Internal Corner	RT7
	300x42mm Leg External Corner 135	RT10

\*Double ended joint - cut to 2 sizes as required. To be used with Mammoth Board.



†Double ended joint - cut to 2 sizes as required. To be used with Universal Board.

Product	Size	Code
<b>Square In-Line Joints</b>		
	300x42mm Leg	RT16

Product	Size	Code
<b>Square Corner joints</b>		
	300x42mm Leg	RT13
	300x42mm Leg Internal Corner	RT18

Product	Size	Code
<b>Ogee In-Line Joints</b>		
	300x50mm	RT11
	500x50mm	RT12*



\*Double ended ogee joint - cut to 2 sizes as required.

Product	Size	Code
<b>Ogee Corner Joints</b>		
	300x50x50mm	RT14
	500x50x50mm	RT15*
	300x42mm leg Ogee Internal Corner	RT17

\*Double ended ogee joint - cut to 2 sizes as required.

Product	Size	Code
<b>Ogee Box End Cover</b>		
	404x60mm	RT19

Product	Size	Code
<b>Bargeboard Moulding Trim</b>		
	500mm	RT22

Product	Size	Code
<b>Finials</b>		
	340mm	RT23
	900mm	RT29

Product	Size	Code
<b>Disc Soffit Ventilator</b>		
	75mm Diameter	RT25

Product	Size	Code
<b>In-Line Jointing Trim</b>		
		RT20

Product	Size	Code
<b>Edge Capping Trims</b>		
		RT21

Product	Size	Code
<b>Soffit Ventilator</b>		
		RT24

Product	Size	Code
<b>Soffit Ventilator with Mesh</b>		
	Internal Corner	RT27

Product	Size	Code
<b>Over Fascia Ventilation 0.5 metre</b>		
	10mm	OFV10

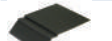
Product	Size	Code
<b>Eaves protection system 1.5 metre</b>		
		EPS

# ROOFLINE, WINDOW & CLADDING SYSTEMS



## Woodgrain PVC-UE Roofline Board and Soffit



Golden Oak (WG)



Black Ash (WB)



Rosewood (WR)



Anthracite Grey (WA)

Product	Foil	Size	Code
---------	------	------	------

### Universal Board - 9mm

Suitable as fascia (refurbishment - install over timber support), window board or reveal liner.

Single Leg

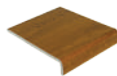

Foil	Size	Code
WG WB WR WA	150mm	U150
WG WB WR WA	175mm	U175
WG WB WR WA	200mm	U200
WG WB WR WA	225mm	U225
WG WB WR WA	250mm	U250
WG WB WR	300mm	U300

Double Leg

WG WB WR WA	454mm	U454
-------------	-------	------

### Mammoth Board - 18mm

Suitable as fascia (replacement/new build install direct to rafters), window board or reveal liner.

Single Leg

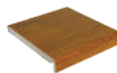

Foil	Size	Code
WG WB WR WA	150mm	M150
WG WB WR WA	175mm	M175
WG WB WR WA	200mm	M200
WG WB WR WA	225mm	M225
WG WB WR WA	250mm	M250

Double Leg

WG WB WR WA	404mm	M404
-------------	-------	------

### Multi-Purpose Soffit Board - 10mm

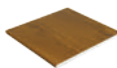

Foil	Size	Code
WG WB WR	100mm	S100
WG WB WR WA	150mm	S150
WG WB WR WA	175mm	S175
WG WB WR WA	200mm	S200
WG WB WR WA	225mm	S225
WG WB WR	250mm	S250
WG WB WR WA	304mm	S304
WG WB WR WA	404mm	S404

Product	Foil	Size	Code
---------	------	------	------

### Vented Soffit - 10mm

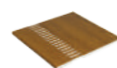

Foil	Size	Code
WG WB WR WA	150mm	V150
WG WB WR WA	175mm	V175
WG WB WR WA	200mm	V200
WG WB WR WA	225mm	V225
WG WB WR	250mm	V250
WG WB WR WA	304mm	V304
WG WB WR WA	404mm	V404

### Double Vented Soffit - 10mm

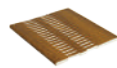

Foil	Size	Code
WG WB WR	175mm	DV175
WG WB WR	200mm	DV200
WG WB WR	250mm	DV250
WG WB WR	304mm	DV304
WG WB WR	404mm	DV404

Vented soffit with a double row of vents is available to special order.

### Hollow Soffit

To be used as a soffit only.



WG WB WR WA	300mm	H300
-------------	-------	------

### Hollow Soffit Trims



WG WB WR WA	'J'	HJ
-------------	-----	----



WG WB WR WA	'H'	HH
-------------	-----	----

### Box End Boards

Universal Board	WG WB WR WA	454mm	UB454
Mammoth Board	WG WB WR WA	404mm	MB404



## Window System Trims

The FloPlast range of Fascia and Soffits, when used in conjunction with the window system trims of quadrants and architraves, provide the means to achieve a high quality dry fix finish to window openings and rooms.

Our flat back 6mm pencil round range of architraves produce an aesthetically pleasing finish to your room. The product is suitable for internal and external use. It is traditionally used for skirting, covering broken plaster around windows and for joints around door linings.

Flexible angles 25mm, 35mm and 75mm wide, have a nitrile modified PVC joint and are suitable as a cover trim for bay window mullions for example.



During installation it is important that the products in the Window System Trims are fixed to a dry and sound substrate. Ensure that the profiles are mitred for external corners and scribe and cut for internal corners. All joints should be fixed using a suitable adhesive or silicone sealant.

Cellular PVC-UE has a thermal expansion similar to rigid PVC, so if secured correctly there should be no relative movement of individual profiles.

When used in accordance with the manufacturers instructions neoprene/rubber solutions, silicone sealant and anaerobic adhesives are suitable for the fixing of cellular PVC-UE trims.

FloTop Stainless Steel plastic headed nails provide a maintenance free fixing in some applications.



Product	Size	Code
<b>Architrave-Pencil Round</b>		
	45x6mm	WT1
	65x6mm	WT2
	95x6mm	WT3
<b>D Section</b>		
	28x6mm	WT4
<b>Edge Fillet</b>		
	20mm	WT5
<b>Quadrant</b>		
	12mm	WT6
	19mm	WT7
<b>Square</b>		
	15x13mm	WT8
<b>Window Board Channel</b>		
	10x5mm	RT21
<b>Angle</b>		
	100x80mm 90° Hollow	WT30
	25x25mm 90° Rigid	WT31
	50x50mm 90° Rigid	WT32
	25x25mm Flexi	WT36
	35x35mm Flexi	WT37
	75x75mm Flexi	WT38





## Woodgrain Window System Trims



Golden Oak (WG)



Black Ash (WB)



Rosewood (WR)



Anthracite Grey (WA)

Product	Foil	Size	Code
---------	------	------	------

### Architrave-Pencil Round

	WG WB WR WA	45x6mm	WT1
	WG WB WR WA	65x6mm	WT2
	WG WB WR WA	95x6mm	WT3

### D Section

	WG WB WR WA	28x6mm	WT4
--	-------------	--------	-----

### Edge Fillet

	WG WB WR	20mm	WT5
--	----------	------	-----

### Quadrant

	WG WB WR	12mm	WT6
	WG WB WR WA	19mm	WT7

Product	Foil	Size	Code
---------	------	------	------

### Square

	WG WB WR	15x13mm	WT8
--	----------	---------	-----

### Angle

	WG WB WR	100x80mm 90° Hollow	WT30
	WG WB WR	25x25mm 90° Rigid	WT31
	WG WB WR	50x50mm 90° Rigid	WT32





## Eaves Box Ends

The versatility and range of FloPlast profiles and accessories allows an extensive choice of detail and appearance when dealing with box ends. The illustrations detailed show some of the industry standard arrangements. Provision should be made for supporting all free edges of the box ends and box end returns as well as soffit boards. Treated softwood battens, securely fixed or tied back to the main structure, will provide a suitable means of support.

### Box End Detail 1: Ogee Board fascia, and bargeboard cut from a section of fascia.



- The box end is usually deeper than the normal fascia run, because of this we offer our 454mm Universal and 404mm Mammoth boards in 1.25 mtr lengths.
- Use corner joints at the front and the back of the box end, and close the back of the box with a section of fascia (if this is deeper than the fascia, use the material supplied for the box end section) this should be slightly deeper than the measured height so that there is no gap between it and the bargeboard soffit.
- Cut the rear corner joint to suit.
- Where the back of the box end exceeds 300mm in height use the double ended 500mm Corner joint.
- Mitre the soffit at 45° and the soffit joint trim (RT20) at both ends.

### Box End Detail 2: Mammoth Board fascia, bargeboard, and box end cut from a section of fascia.



- The box end is usually deeper than the normal fascia run, because of this, we offer our 454mm Universal and 404mm Mammoth boards in 1.25 mtr lengths.
- Use corner joints at the front and the back of the box end, and close the back of the box with a section of fascia (if this is deeper than the fascia, use the material supplied for the box end section) this should be slightly deeper than the measured height so that there is no gap between it and the bargeboard soffit.
- Cut the rear corner joint to suit.
- Where the back of the box end exceeds 300mm in height use the double ended 500mm Corner joint.
- The soffit is extended into the box end by butt jointing Multi Purpose Board cut to suit.

### Box End Detail 3: Mammoth Board fascia, bargeboard, and box end cut from a section of fascia.



- The box end is usually deeper than the normal fascia run, because of this we offer our 454mm Universal and 404mm Mammoth boards in 1.25 mtr lengths.
- Use corner joints at the front and the back of the box end, and an In-line Joint between the bargeboard and the box end section. Close the back of the box with a section of fascia (if this is deeper than the fascia, use the material supplied for the box end section) this should be slightly deeper than the measured height so that there is no gap between it and the bargeboard soffit.
- Cut and mitre the rear corner joint to suit.
- Where the back of the box end exceeds 300mm in height use the double ended 500mm Corner joint.
- Mitre the soffit at 45° and the soffit joint trim (RT20) at both ends.



## Eaves Box Ends

### Box End Detail 1a

Standard Ogee Board with a vertical cut end, fixed directly to the gable rafter

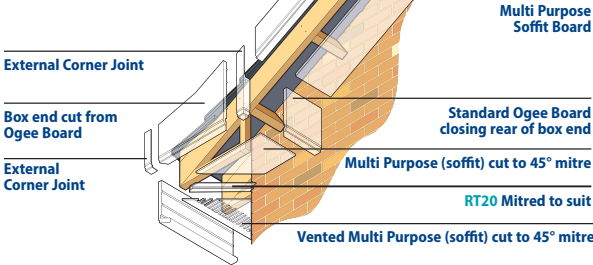

1b

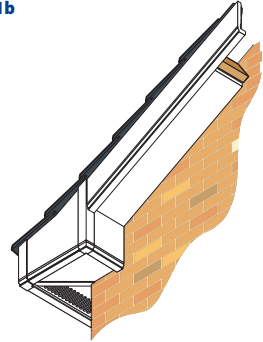

### Box End Detail 2a

Mammoth/Universal Board with a vertical cut end, fixed directly to the gable rafter

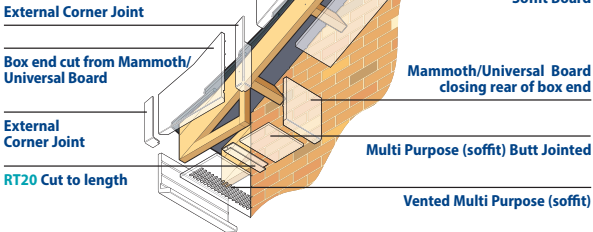

2b

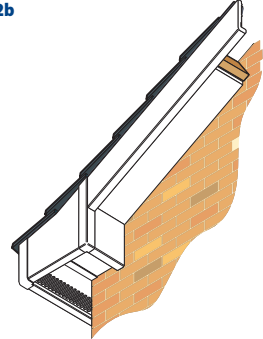

### Box End Detail 3a

Mammoth/Universal Board with a square cut end, fixed directly to the gable rafter

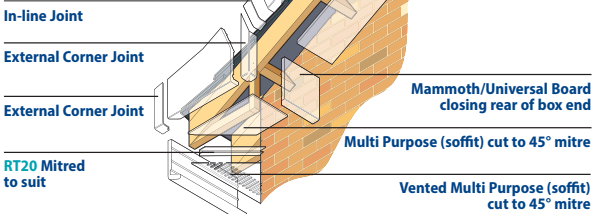

3b

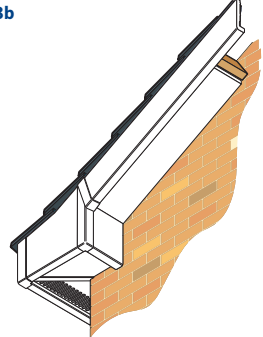



## Eaves Box Ends and Decorative Bargeboard

### Box End Detail 4: Mammoth Board fascia, bargeboard, and box end cut from a section of fascia.



- The box end is usually deeper than the normal fascia run, because of this we offer our 454mm Universal and 404mm Mammoth boards in 1.25 mtr lengths.
- Use corner joints at the front of the box end, a Board End Moulding to finish the rear edge of the box end, and an In-Line Joint between the bargeboard and the box end section.
- Close the back of the box with a section of fascia (if this is deeper than the fascia, use the material supplied for the box end section) this should be slightly deeper than the measured height so that there is no gap between it and the bargeboard soffit.

### Box End Detail 5: Bargeboard extending to meet the fascia.



- A triangular fillet cut from a suitable piece of FloPlast board is set above the bargeboard, and fixed with FloTop nails to the tilt fillet on the gable rafter, another fillet, with either the return leg intact or removed, is fixed with FloTop nails to timber framing supported by the gable ladder, if the return leg is removed the bottom cut edge is protected by attaching a Board End Moulding. The triangular off cuts may be closely butt jointed and finished with low modulus silicone to the top and bottom edges of the bargeboard.
- Use corner joints at the front and the back of the box end cut to suit.
- Close the back of the box with a section of fascia (if this is deeper than the fascia, use the material supplied for the box end section) this should be lightly deeper than the measured height so that there is no gap between it and the bargeboard soffit.

### FloPlast Decorative Bargeboard Moulding

The FloPlast Decorative Bargeboard Moulding offers style and character to most roofline installations. Once installed, it will require very little maintenance, as it will not rot, warp or require painting.

A variety of patterns can be achieved at the bargeboard apex, and two suggested examples are shown below. A finial joint is available to add that extra touch of elegance to your home.

### Decorative Moulding Installation

Measure the length of your bargeboard and calculate how many mouldings are required at 500mm per moulding, making an allowance for design and plumb cuts at the ridge and barge ends.

Cut to size and screw using four 15mm x 6 self tapping screws, to the underside of the existing FloPlast PVC-UE bargeboard. Seal the joint between the moulding and bargeboard with either a low modulus silicone, or an appropriate adhesive.

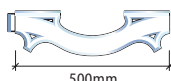



## Eaves Box Ends and Decorative Bargeboard

**Box End Detail 4a**

Mammoth/Universal Board with a square cut end, fixed directly to the gable rafter

In-Line Joint

External Corner Joint

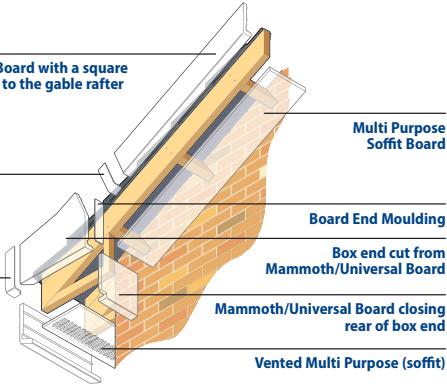

Multi Purpose Soffit Board

Board End Moulding

Box end cut from Mammoth/Universal Board

Mammoth/Universal Board closing rear of box end

Vented Multi Purpose (soffit)

**4b**

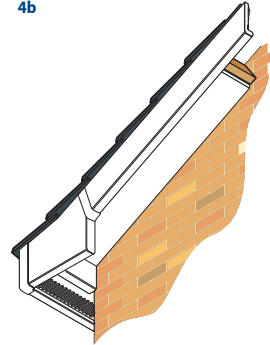

**Box End Detail 5a**

Mammoth/Universal Board with a vertical cut end, fixed directly to the gable rafter

External Corner Joint

Fillets cut from a suitable piece of FloPlast board

External Corner Joint

Alternative Board End Moulding

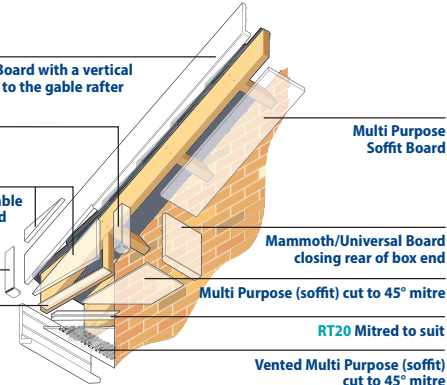

Multi Purpose Soffit Board

Mammoth/Universal Board closing rear of box end

Multi Purpose (soffit) cut to 45° mitre

RT20 Mitred to suit

Vented Multi Purpose (soffit) cut to 45° mitre

**5b**

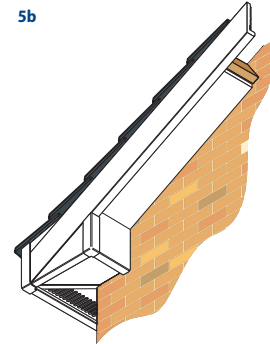

### Decorative Bargeboard Moulding

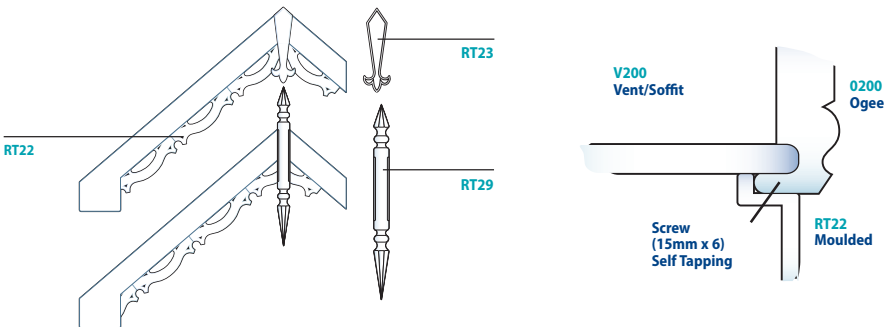

RT22

RT23

RT29

V200 Vent/Soffit

O200 Ogee

Screw (15mm x 6) Self Tapping

RT22 Moulded



## Installation Details

### Refurbishment

#### Universal/Ogee Board and Multi-Purpose Soffit

The Fascia should have a suitable existing or new backboard. The universal/ogee board should be fixed so that the weight of the eaves course of tiles is distributed across the backboard and/or tilt fillets.

The soffit board should be supported on bearers at the foot of every rafter and be securely supported at each end. A preferred method is to support them by battens nailed or screwed to the rafters as shown in the diagrams. The bearers should be checked for line and level and suitable packing installed where necessary. All timbers should be treated with preservative.

When installing laminated woodgrain products, fixing centres should be reduced to a maximum of 400mm.

Eaves course of tiles taken up and replaced on completion

Eaves Protection System

Universal Board fixed to existing sound timber fascia or min 12mm marine ply with 50mm FloTop nails

Sarking felt

Multi-Purpose soffit fixed to bearers with 40mm FloTop pins at max. 600mm c/c

### New Build/Replacement

#### Mammoth Board and Vented Soffit

When Mammoth Fascia is specified the roof covering should be supported by adequate means at the rafter ends. This can be by means of a tilt fillet, lay board or a shaped batten which extends the full length of the roof line. A lay board is particularly desirable in the case of pitches less than 30° as it will prevent any sagging of the Sarking felt.

Vented soffit boards are available in a range of sizes when roof ventilation via the soffit is specified. The boards fit into the groove of the Mammoth Board and should be fixed to suitable soffit bearers.

When installing laminated woodgrain products, fixing centres should be reduced to a maximum of 400mm.

Tilt fillet or batten

Eaves Protection System

Soffit board engages between fascia/backboard and overcapping

Sarking felt

Vented multi-purpose soffit fixed to bearers with 40mm FloTop pins at max. 600mm c/c



## Installation Details

### New Build/Replacement

#### (C) Mammoth Board and Multi-Purpose Soffit

It is not always necessary for the soffit to fit into the groove at the back of the Mammoth board. Diagram (c) shows a deeper Mammoth fascia, which has been chosen for design or appearance criteria, the Multi-Purpose soffit butts against the back of the Mammoth board and is fixed to each soffit bearer with two 40mm FloTop Pins.

When installing laminated woodgrain products, fixing centres should be reduced to a maximum of 400mm.

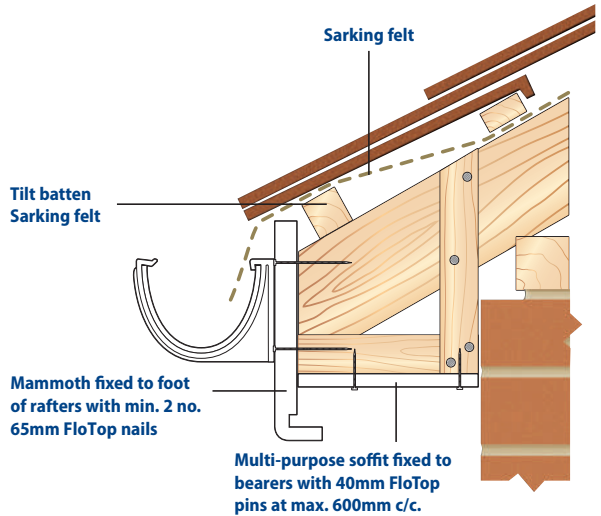

### New Build/Replacement

#### (D) Mammoth Ogee Board and Vented Soffit

The diagram shows the Ogee style Mammoth Fascia; the appearance of this board makes it particularly favourable for the specifier and homeowner alike when trying to achieve a period appearance.

When used in conjunction with Decorative Bargeboard Mouldings and Niagara® gutter, an otherwise mundane appearance can be transformed into an aesthetically pleasing feature to a property.

When installing laminated woodgrain products, fixing centres should be reduced to a maximum of 400mm.

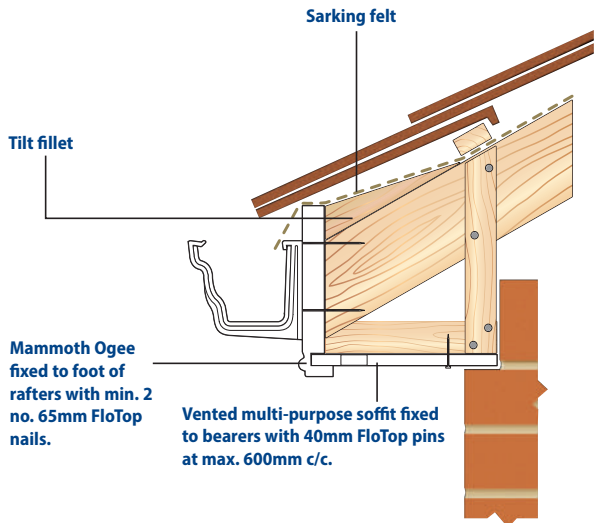



## Cladding Systems BS EN 13245-2 Attestation Level 4



The FloPlast PVC-UE Cladding Systems are suitable for external use on buildings as a decorative and protective facing, fixed vertically, horizontally or diagonally over both brick, block, masonry and timber framed walling. When installed correctly this will reduce thermal loss by providing an additional external barrier.

Available in two designs (**Shiplap** and **Open Vee**) resembling existing timber profiles. The weather tight joint provided prevents penetration from the elements.

The systems are completed with a range of trims to suit all applications.

The tough and durable finish has a high impact strength and a weather resistant skin which requires little maintenance to retain its excellent appearance.

PVC Cladding Systems has been assessed and given an A+ rating, which allows the specifier/housebuilder to claim the code for sustainable homes maximum of three points when using PVC cladding on an external wall system.

For more information please refer to our BBA certificate 00/3772



### Performance in relation to fire

The system achieved a reaction to fire classification\* of D-s3, d2/(AHM) to BS EN 13501-1 : 2007.

The system is not classified as non-combustible and may be used on buildings with no storey 18m or more above the ground and 1m or more from a boundary. With minor exceptions, the system should be included in calculations of unprotected area.

## White PVC-UE Cladding Systems

Product	Code
<b>100mm V Joint Cladding</b> 	C100
<b>150mm Shiplap Cladding</b> 	C150
<b>Top Edge Trim (two part)</b> 	CT1
<b>Starter Trim</b> 	CT2

Product	Code
<b>Universal Channel</b> 	CT3
<b>Drip Trim</b> 	CT4
<b>Internal/External Corner (two part)</b> 	CT5
<b>Centre Joint Trim</b> 	CT7







## Woodgrain Foiled PVC-UE Cladding Systems



Product	Code	Foil	Price*
<b>100mm V Joint Cladding</b>			
	C100	WG WB WR	83.38

<b>150mm Shiplap Cladding</b>			
	C150	WG WB WR WA	113.32

<b>Top Edge Trim (two part)</b>			
	CT1	WG WB WR WA	95.14

<b>Starter trim</b>			
	CT2	WG WB WR WA	51.30

<b>Universal Channel:</b>			
	CT3	WG WB WR WA	57.70

Product	Code	Foil	Price*
<b>Drip Trims</b>			
	CT4	WG WB WR WA	57.70

<b>External Corner (two part) External corner foiled</b>			
	CT5	WG WB WR WA	143.25

<b>Internal Corner (two part) Internal corner foiled</b>			
	CT6	WG WB WR WA	143.25

<b>Centre Joint Trim</b>			
	CT7	WG WB WR WA	65.23





## Cladding Installation

### Horizontal Fixing

FloPlast 150mm Shiplap and 100mm V Joint Cladding, should be fixed at centres not exceeding 600mm. If installation is to be above second storey height, then this should be reduced to 400mm.

When installing laminated woodgrain products, fixing centres should also be a maximum of 400mm.

Working from a level line, the starter trim (A) is fixed to timber studs or battens using the specified 30mm cladding pins. All other framing trims are then fitted. Where two-part Trims are required (Top edge trim, or external and internal corners (B)), only the back half is fixed at this stage (C&D).

The bottom cladding plank is then located firmly in the starter trim and vertical trims, and fixed into place using the specified 30mm cladding pins, starting at one end, or working from the centre outwards. At the end of each plank a 5mm gap should be allowed for expansion.

Where necessary, trims and planks are cut to size and shape (e.g. along the verge) with a fine toothed saw.

Subsequent planks are fitted into the preceding planks, ensuring that the tongue-and-groove joint is firmly closed and nail heads are concealed.

If it becomes necessary to cut the top plank to fit the remaining space, then off cuts of Cladding should be placed behind the cut plank at each fixing centre.

Where sections longer than 5m are to be clad, Butt Joints of adjacent cladding planks should be concealed with an individual butt joint trim or by a centre Joint trim fixed to a batten or stud, and a 10mm expansion gap should be allowed between the planks. For aesthetic reasons the positioning of any centre Joint trims should be taken into account at the planning stage.

Where two-part trims have been used, fastening the front part of the Trim completes the installation.

If individual butt joint trims are used to join two or more cladding planks they should be spaced so that they do not impede the expansion of another butt joint above or below.

### Bottom (Starter) edge detail (A) - Side Section

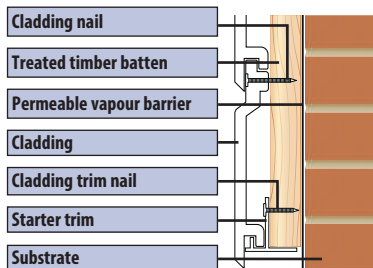

### Bottom (Starter) edge detail (A) - Side Section

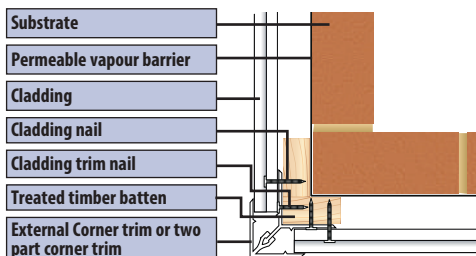

\*Note: A horizontal-cladding batten must support the Top edge trim. At least 8mm clearance must be allowed between the top of the last plank and the inside of the male extrusion of the top-edge trim. This allows for the last plank to be located and thermal movement to take place.

### Top edge detail (B) - Side Section

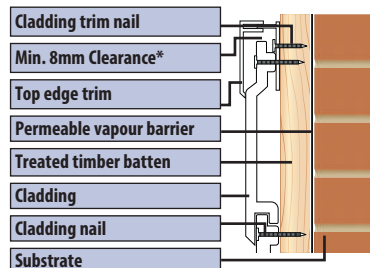

### Top edge detail (B) - Side Section

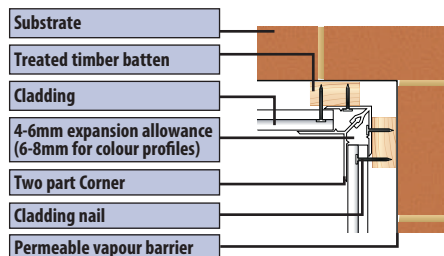



## Cladding Installation



1. Fix perimeter frame and intermediate vertical battens to wall

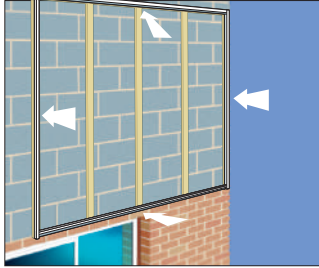

2. Fix all perimeter trims



3. Fit first plank at base



4. Fit remaining planks and engage male part of two-part trims



5. Ideal joint design when using individual butt joints.



### Ventilation

A minimum clear air space of 38mm must be provided behind the cladding, and this can be achieved, by using 50 x 38mm recommended battens. If insulation material is used the gap must be kept clear to allow air to circulate at all times.

### Weatherproofing

The FloPlast cladding system is not air or water vapour tight, but will withstand normal weather conditions owing to its interlocking joint. It is advised that when used on timber studding, or walls which are not fully weathertight or subject to exposed conditions, that the system should be backed by a vapour permeable membrane.

Requirements for drainage must be made to allow for any driving water that has penetrated. To achieve this 10mm holes should be positioned every metre in the horizontal lower batten.

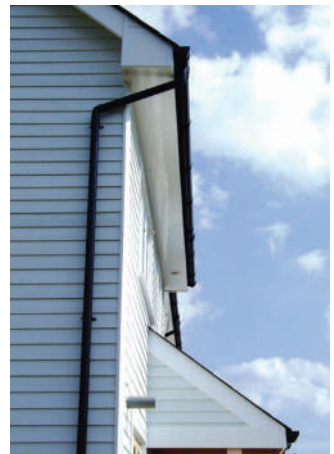



## Over Fascia Ventilation and Eaves Protection System

FloPlast offer a range of ventilation options which comply with the current Building Regulations 1991 (England and Wales) requirement F2, the Building Regulations (Northern Ireland) 1990 and NHBC recommendations.

The regulations are designed to limit condensation risks in a roof void constructed above an insulated ceiling.

Available in 1.5 metre lengths, Eaves Protection System can be used for refurbishment projects to replace rotted gutter felt and, in new build applications, it reduces long term eaves maintenance problems by directing water away from the underlay into the gutter. It also supports the underlay which prevents 'ponding' behind the fascia board.

Adjoining strips should be overlapped by 150mm and fixed at 200mm centres.

### Over Fascia Vent Strip

Available with the equivalent of 10mm continuous air gap to suit current regulations. The 10mm is supplied in 5 metre packs, each section measuring 28mm H x 35mm D x 500mm L interlinks and has fixing points for ease of installation.

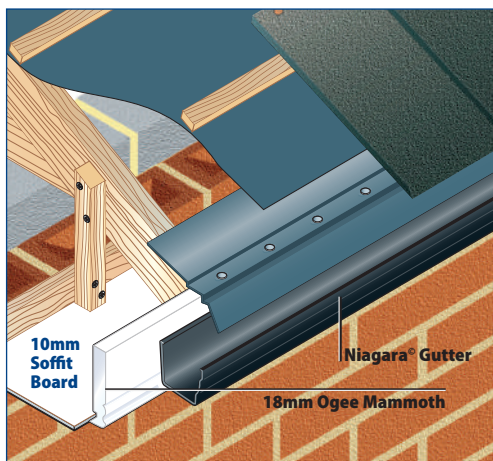





Because of the added height, when using over fascia ventilation, an allowance to reduce the size of the fascia board should be considered.

Pitched Roof	Allowance
0° - 50°	10mm
51° - 55°	20mm
56° - 60°	30mm
61° - 65°	35mm
66° - 70°	40mm

Over fascia vent strip has an integral inhibitor to exclude large insects and vermin from the roof void. 65mm x 3.35mm diameter galvanised steel nails, fixed at 200mm centres should be used to fix the Over Fascia Ventilation System.

Pre-vented Soffit boards are also available with the equivalent of 10mm and 25mm continuous air gap. The disc and soffit ventilator strips add variety and flexibility for the specifier and installer ensuring building regulations are met in all situations.

Product	Size	Code
<b>Soffit Ventilator:</b>		
		RT24
<b>Disc Soffit Ventilator:</b>		
		RT25
<b>Soffit Ventilator with Mesh:</b>		
		RT27
<b>Over Fascia Ventilation &amp; Eaves protection system</b>		
Over Fascia Ventilation:		
	10mm	OFV10
Eaves Protection System:		
		EPS



## Technical Specification

### Composition

FloPlast Cellular PVC Profiles are manufactured by a co-extrusion process in which a high impact PVC-U (unplasticised expanded polyvinyl chloride) compound is co-extruded onto the outer surface of a foamed PVC-UE Cellular Core, cooled and formed to section, then cut to length and width as required.

PVC-UE has a high degree of thermal insulation and is resistant to acids, alkalis, seawater and atmospheric pollution.

### Maintenance

Cellular PVC components have a consistent self-finish and colour and are low maintenance. To restore to an 'as new' surface appearance, occasional washing with a non-scratch mild detergent and water will remove surface grime particularly in polluted atmosphere. Do not use solvents or abrasive cleaners.

Painting is not recommended as it can effect the impact strength of the product and the application of dark colours could lead to thermal distortion. However should painting be required for design or style considerations, use a good quality satin polyurethane paint.

### Durability

The tough co-extruded outer skin provides excellent all year round weathering. Some natural shading over a number of years will occur due to the natural weathering process. Any slight colour change or surface dulling which might occur will be uniform over the visible exposed surfaces of the products and will remain an effective system for a period in excess of 35 years.

### Site Work/Fixing

FloPlast products undergo rigorous quality control checks in the factory, during and after manufacture. Should there be any defect for whatever reason, it should be reported to FloPlast immediately to enable us to carry out an inspection.

The protective film on the co-extrusion should be removed just prior to fitting. Should a defect become apparent at this stage the product should not be fitted.

FloPlast Cellular Boards are easily cut, routed and drilled using conventional woodworking tools. Stainless steel pins/nails should be used for fixing.

Saws with fine-toothed blades should be used and power tools should be operated at the same or higher speeds to those normally used for timberwork, with carbide tipped blades. Ensure that a face mask and eye protectors are worn. Take additional care with the product close to or below freezing point, as low temperatures tend to make the product brittle. The product should not be fixed in temperatures above 25°C, or exposed to direct sunlight prior to fixing which may cause thermal distortion.

Correct fixings and fixing procedures should always be followed and the product secured to a sound substructure.

A 10mm gap must be provided for thermal expansion at joints and plank ends.

### Behaviour in relation to fire:

- **Boards**  
The cellular boards achieve a Class 2Y surface-spread-of-flame rating when tested in accordance with BS 476-7.
- **Hollow Soffit**  
The hollow soffits achieve a Class 1Y surface-spread-of-flame rating when tested in accordance with BS 476-7
- **Foiled Products**  
The Renolit foil applied to FloPlast's cladding, boards or hollow soffit systems has been tested and achieved the following fire rating:

When tested in accordance with DIN4012-B2 and DIN EN ISO13501-1, the requirements according to RAL-GZ716/1 Section I Part 7 are fully met.

### General

On exposure to fire, PVC-U tends to char and may fall away. The spread of flame along its surface is limited. It is unlikely that the roof trim system will significantly affect the overall fire performance of any roof in which it is installed.

Where it is normal practice to carry the eaves box over, between dwellings, it is important that the box is fire-stopped at compartment walls with a proprietary fire stop material.

PVC-UE Fascia soffit and cladding should not be installed on applications above 18mtrs in height.



## General Information

### Transport, Handling and Storage

FloPlast products are wrapped in polythene sleeving in specified pack quantities to guard against damage during transportation and storage. Care should be taken in their handling and they should be stored in stacks not exceeding one metre in height.

It is important that products are stored flat and fully supported on a firm base at temperatures below 30° C. Screen from direct sunlight to avoid rapid build-up of temperatures inside polythene sleeves.

The co-extruded surfaces are protected by a polythene film which should be removed just prior to installation.

### Quality Control

FloPlast Cellular and rigid boards are manufactured within a quality management system which has been assessed by BSI and complies with the requirements of BS EN ISO 9001:2015 (Certificate no. FM501414).

Continuous quality control procedures are in place during and after manufacture to check appearance, dimensions, weight per metre, heat reversion, heat ageing and impact strength.

### Terms and Conditions of sale

Goods are sold subject to our Standard Terms and Conditions of Sale, which are available upon request. FloPlast Limited reserves the right to modify or extend any product range or published information without prior notice.

## Model Specification

Fascias, Soffit's and Bargeboards are to be constructed using FloPlast Cellular and Rigid PVC Roof Trim System Profiles manufactured in accordance with BS7619 - Cellular PVC-UE, approved by the British Board of Agrément 00/3771 and within the requirements of BS EN ISO 9001.

Boards are white or have a woodgrain effect laminated finish and fixing should be in accordance with normally accepted practice. Boards are to be fixed using plastic-

### Summary

- Boards to be fixed only at temperatures above 5°C and below 25°C.
- Fixings at a maximum of 600mm (400mm for cladding above two storey height, and laminated woodgrain products).
- Secure boards to sound timber only replacing any rotten timber with new treated softwood.
- Use adequate length of nails/pins.
- A 5mm gap to be allowed for thermal movement at joints and at box ends.

### FloPlast Fascia Systems are not load bearing

- Eaves tiles should be adequately supported.
- Provide ventilation to roof space in accordance with current Building Regulations.
- Use eye protection when using power tools to cut or drill boards.
- Leave a clear air space of 38mm behind the Cladding.
- Ensure battens for Cladding are secured to a firm substrate.
- Remove all offcuts and dispose of environmentally.

headed stainless steel nails of an appropriate length, and secured to rafter feet, noggins and gable ladders.

Old Fascias, Soffit's and Bargeboards should preferably be removed, existing timber rafters and supports are to be inspected, and any rotten timber replaced with new treated softwood.

The Sarking felt should be examined, and replaced if any signs of damage or wear are found.



## Fixing Details

**Fascia (I) - Universal/Ogee Board** are to be constructed from Universal/Ogee Board with a nominal thickness of 10mm or Hockey Board with a nominal thickness of 9mm, secured at 600mm centres, to treated battens or a backing board, with 50mm plastic-headed nails, with a minimum of 2 fixings per centre. 400mm centres for laminated woodgrain.

Joints to be supported and made at rafter feet, with both ends fixed, leaving a 10mm air gap and be covered with a joint trim, secured in position with Silicone Sealant, a proprietary adhesive or pins.

Gutter brackets are fixed through the Fascia into supporting timberwork, normally the rafter feet or backing board, with 40mm x 10 stainless steel screws.

**Fascia (II) - Mammoth/Ogee Mammoth Board** are to be constructed from Mammoth/Ogee Mammoth Board with a nominal thickness of 18mm or Mammoth Bullnose Fascia with a nominal thickness of 16mm, secured at 600mm centres to rafter feet with 65mm plastic-headed nails, 400mm centres for laminated woodgrain with a minimum of 2 fixings per rafter.

Joints to be supported and made at rafter feet, with both ends fixed, leaving a 10mm expansion gap and be covered with a joint trim, secured in position with Silicone sealant, a proprietary adhesive or nails.

Gutter brackets are fixed through the Fascia, with 40mm x 10 stainless steel screws.

**Bargeboards (I) - Universal/Ogee Board** are to be constructed from Universal/Ogee Board with a nominal thickness of 10mm or Hockey Board with a nominal thickness of 9mm, secured at 600mm centres to noggins and gable ladders with 50mm plastic-headed nails, with a minimum of 2 fixings per centre. 400mm centres for laminated woodgrain.

Joints are to be supported and secured as per Fascia Boards detail.

The ridge is to be joined using an appropriate trim with boards cut to the required angle.

**Bargeboards (II) - Mammoth/Ogee Mammoth Board** are to be constructed from Mammoth/Ogee Mammoth Board with a nominal thickness of 18mm or Mammoth Bullnose Fascia with a nominal thickness of 16mm, secured at 600mm centres to noggins and gable ladders, with 65mm plastic-headed nails, with a minimum of 2 fixings per centre. 400mm centres for laminated woodgrain.

Joints are to be supported and secured as per Fascia boards detail.

The ridge is to be joined using an appropriate trim with boards cut to the required angle.

**Soffits - Multi-Purpose Board/Hollow Soffit/Cladding Soffit** are to be constructed from PVC-UE Multi-Purpose Board, Rigid PVC-U Hollow Soffit or Cladded Soffit, and secured at 600mm centres to timber eave hangers, noggins or underside of rafters with 40mm plastic-headed nails, with a minimum of 2 fixings per centre, and 30mm stainless steel nails for Cladded profiles. 400mm centres for laminated woodgrain.

Soffit corner returns are made by cutting the boards to the appropriate angle and joining with an 'H' Trim. Soffit widths are not to exceed 200mm unsupported.

Extra widths are to be joined using a Longitudinal Coupling Trim, leaving a 5mm gap at each end for thermal expansion. Soffits are to be positioned on the cover board lip or secured within the Fascia groove of Mammoth Board, butt jointed with a 5mm gap at each end for expansion and secured by trim.



# FloPlast

building the future

## Contact Details:

FloPlast Limited  
 Castle Road  
 Eurolink Business Park  
 Sittingbourne  
 Kent ME10 3FP  
 UK

**Tel**  
 01795 431731

**Sales Office Direct Line**  
 01795 421422

**Fax**  
 01795 431188

**E-mail**  
 sales@floplast.co.uk

**Website**  
 www.floplast.co.uk



April 2020

## Brochures available:

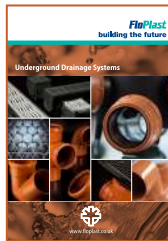
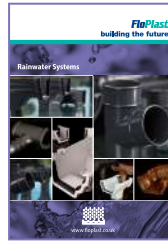

Roofline, Window and Cladding Systems



Rainwater Systems



Soil & Waste Systems



Underground Drainage Systems



MDPE Systems



Hot & Cold Plumbing Systems