



SPECIFICATION GUIDE



Tel 03443 715 523
www.domusventilation.co.uk



Contents

Introduction	3	DUCTING RANGE	39
Best Practice Guide	4	Rigid Ducting	40
Indoor Air Quality	8	Rigid Duct Flow Control Plenum for Architectural Grilles	74
Mechanical Ventilation Products	9	Flexible and Semi-Rigid	76
DME100	10	Ducting Ancillaries	83
Controls Options	13	Domus Radial	86
System 3 CMX-S	14	Domus Adapt	89
System 3 CMX-MULTI	17	Thermal Duct Insulation	95
System 4 HRXE	20	Fire Solutions	97
System 4 HRX2D	23	Grilles and Terminals	100
System 4 HRX-aQ	26	Attenuation	108
System - NOX-FILT	30		
Intermittent Extract Fans	32		



► Introduction

Domus Ventilation is a manufacturer of market-leading ventilation systems that save energy and improve indoor air quality.



From project concept through to completion Domus Ventilation can guide you through the whole process

Formerly Polypipe Ventilation, the company has been reborn as Domus Ventilation, with new management and customer service teams, an expanded sales network and state-of-the-art production facilities in South Wales.

Domus Ventilation will continue to offer the multi award-winning Domus ducting, that has been a UK market leader for over 50 years, as well as energy-efficient ventilation and indoor air quality systems.

Under the new name, and with an enhanced customer service team and increased sales force, Domus Ventilation is primed for growth and aims to be the number one supplier of ventilation products and accessories.

As a leading manufacturer of energy-saving ventilation systems, we offer high quality solutions for domestic and light commercial applications.

► Technical Support

Understanding your ventilation requirements is integral to ensuring that we tailor our solutions to meet your needs.

► Product Specification

Having established technical requirements you will be supported each step of the way from order placement through to time planning.

► Stockists

Two significant manufacturing facilities that help guarantee quick availability through a loyal nationwide network of Merchant and Electrical Wholesaler stockists.

► Delivery

Our national network of stockists, we offer a dedicated and managed logistics fleet, who are dedicated to providing efficient, quick and reliable delivery.

► Customer Services

We believe at Domus Ventilation we have the best people within the industry working together to support all our customers providing you with expert advice and guidance.



► Best Practice Guide

The following is offered as Best Practice guidance only, with information taken from statutory body's including 'Approved Document F – Ventilation (2010 edition incorporating 2010 and 2013 amendments).

All Domus Ventilation products comply with the latest regulatory governance, with supporting literature such as Installation & Maintenance manuals.

Duct arrangement

External vents should be separated by a minimum of 300mm horizontally if placed on the same façade.

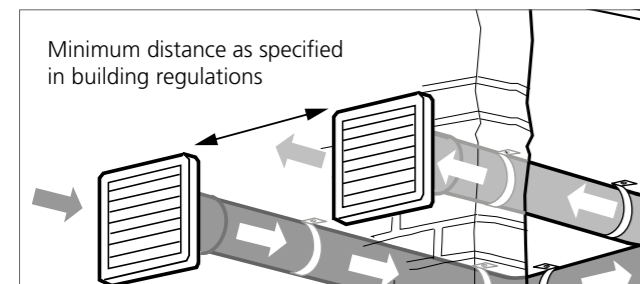

Fixing and supporting ducts

Duct clips or support banding should be positioned at equal distances and no more than 750mm apart. Ducting should not be positioned in direct contact with other surfaces, such as plasterboard ceilings, to prevent noise transfer into the dwelling.

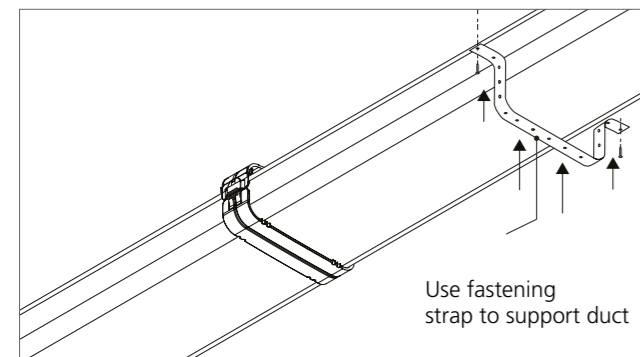

Joining of ducts

We recommend that all ducts be connected and sealed using a non-hardening sealant to minimise air leakage. Consideration should be made to ducts installed in non-accessible areas, such as a ceiling void, to have a permanent fixing in place to supplement the sealing preventing dislodging or movement during or after installation. The use of duct tape is permitted but should not be used as the only method of providing an airtight seal.

Sizing of ducts

All ducting should be sized in accordance with current building regulations. When using MEV and MVHR systems, the cutting selected should be suitable for use with the product types.

Domus Ventilation recommends that a minimum duct size of 204x60mm or 125mm be used with MEV and MVHR systems to maintain an even distribution of airflow and low duct velocity.

Please see pages 39-71 for all pressure drop calculations on our rigid ducting systems.

Domus semi-rigid radial ducting systems may also be used, contact Domus Ventilation for further information.

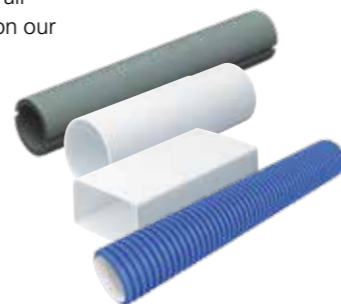

Installation best practice

Installation and positioning of air valves and external grilles:

- The air valve shall be located on the opposite side of the room from internal opening doors creating a cross flow of air
- Should not be located less than 200mm to walls when installed on a ceiling
- Should not be located less than 400mm from a ceiling when installed on a wall
- Kitchen extract grilles should be a minimum of 600mm away from the hob

Air Valves should be lockable to prevent tampering once the system has been installed and commissioned.

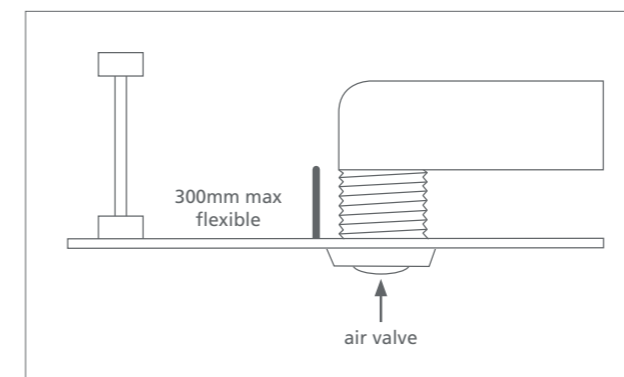

All grille locations should take into consideration room layouts and be positioned in such a way to minimise down draughts over seating and sleeping areas.

Image	Part No	Diameter	Application		
			Wall	Sus Ceiling	Fire Rated
	136-04	100mm	✓		
	136-05	125mm			
	136-06	150mm			
	136-24	100mm		✓	
	136-25	125mm			
	136-26	150mm			
	136FR-24m	100mm			✓
	136FR-25m	125mm			
	136FR-26m	150mm			

Extract ventilation rates

Room	Extract Ventilation Rates		Minimum low rate
	Intermittent Extract	Continuous Extract	
	Minimum rate	Minimum high rate	
Kitchen	30l/s adjacent to hob, or 60l/s elsewhere	13l/s	Total extract rate should be at least the whole dwelling ventilation rate given in the table below.
Utility Room	30l/s	8l/s	
Bathroom	15l/s	8l/s	
Sanitary Accommodation	6l/s	6l/s	

	Whole Dwelling Ventilation Rates				
	Number of bedrooms in dwelling				
	1	2	3	4	5
Whole dwelling ventilation rate a.b. (l/s)	13	17	21	25	29

Note:

- a. In addition, the minimum ventilation rates should be no less than 0.3l/s per m² of internal floor area (this includes all floors, e.g. for a two-storey building, add the ground and first floor areas).
- b. This is based on two occupants in the main bedroom and a single occupant in all other bedrooms. This should be used as the default value. If a greater level of occupancy is expected, add 4l/s per occupant.

Flexible ducting use with intermittent fans

For flexible duct connected to axial fans the length is limited to 1.5 metres; for centrifugal fans the length limit is 6 metres (for extract rates 6 to 30l/s), and 3 metres (for extract rates 31-60l/s).

The number of bends is limited to two for up to 30l/s, and reduces to one bend for higher extract rates.

Flexible duct should be pulled taught to ensure that the full internal diameter is obtained and flow resistance minimised.

This is considered to have been achieved if the duct is extended to 90% of its maximum length.

Flexible ducting generally requires more support than rigid ducting.

It is suggested that flexible ducts should be supported at intervals not exceeding 600mm.

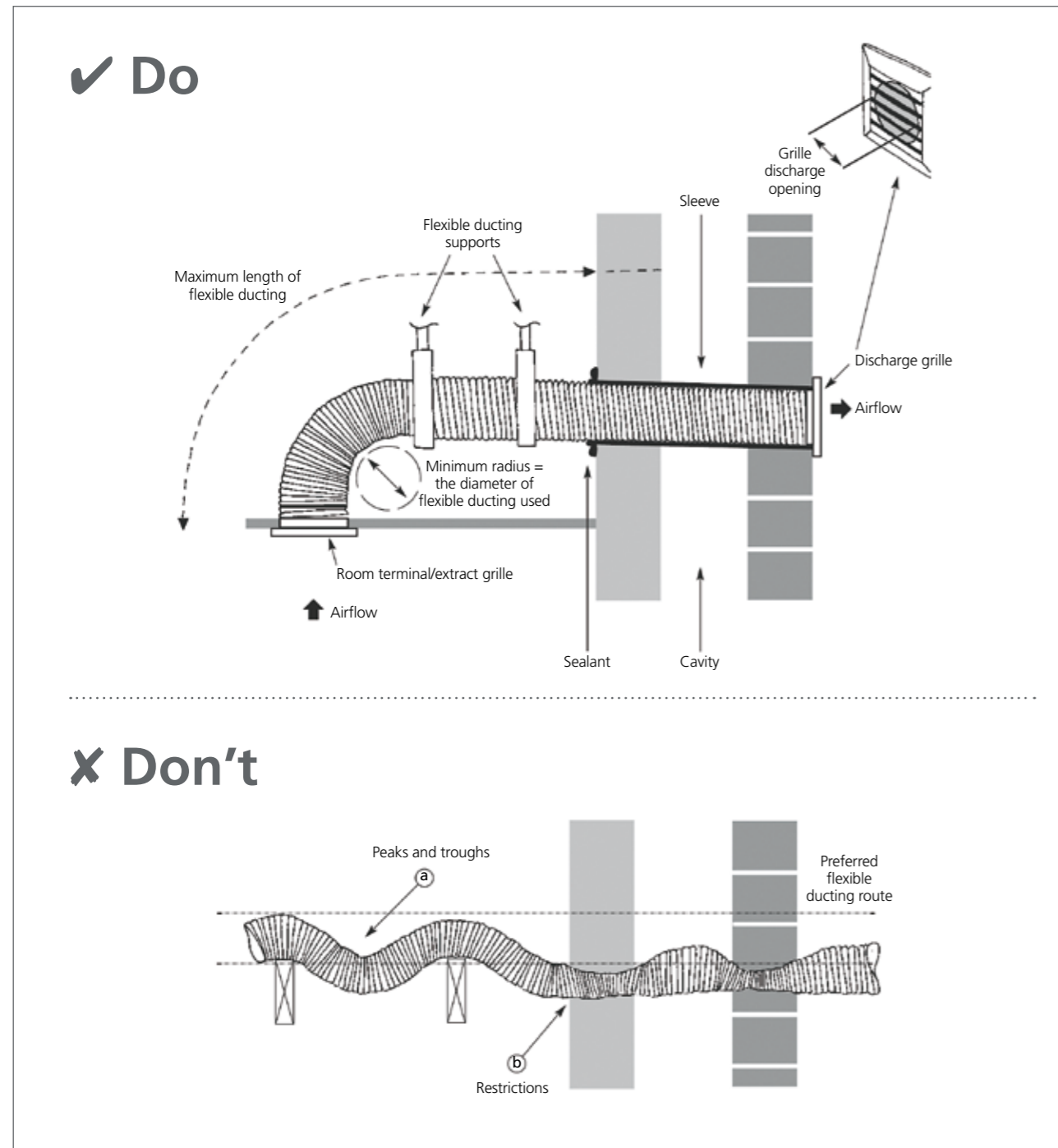

Flexible ducting use with MVHR

Flexible duct should be:

- ▶ Not more than 300mm in length
- ▶ Located adjacent to fan units or air valves
- ▶ Not used to form bends

Position of terminals

To prevent cross-contamination, supply ductwork terminals should normally be separated from exhaust ductwork terminals and other potential sources of pollution by a minimum of 1m measured on plan. Increased separation distances may be required between the supply and any:

- ▶ Soil and vent pipe terminal
- ▶ Boiler flue outlet
- ▶ Biomass or solid fuel chimney terminal

Fire stopping

Proprietary fire components should be suitably tested and specified to take account of the test conditions. Appropriate standards include:

- ▶ BS 476 Fire tests on building materials and structures (relevant parts)
- ▶ BS EN 1365-2 Fire resistance tests for loadbearing elements. Floors and roofs
- ▶ BS EN 1366-3 Fire resistance tests for service installations. Penetration seals

Air valves and terminals

Air valves and terminals should be specified to be suitable for their location and function, and the velocity of the system. Airflow resistance should be calculated in accordance with BS EN 13141-2 Ventilation for buildings. Performance testing of components/products for residential ventilation. Exhaust and supply air terminal devices.

Adjustable air valves should be lockable, to prevent building users from altering them.

Terminals should be designed to prevent the entry of birds and animals.



Control of condensation

Condensate can form where ducts pass through spaces outside of the insulated parts of the home (such as a roof void) or when ductwork carrying cold air passes through spaces within the insulated parts of the home. Ductwork should be insulated to reduce the risk of condensation formation.

Where insulation is required to prevent condensation formation, it should be continuous and vapour resistant. This can be achieved by using either suitable pre-insulated ductwork or a proprietary insulation system with a thermal resistance equivalent to a minimum of 25mm of insulating material with a thermal conductivity of 0.04W/(m.k).

Type of duct	Ductwork continuously insulated	
	Ductwork located inside the insulated part of the home	Ductwork located outside of the insulated part of the home
Supply	Yes	Yes
Extract	Yes	Yes
Service (supply and extract)	No	Yes

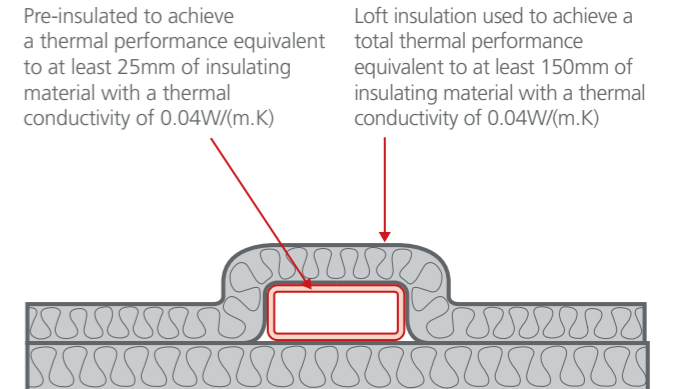

Indoor Air Quality (IAQ)

Whilst there are currently no regulations concerning the quality of air inside a property, the subject of IAQ has been well publicised over the last few years due to rising health concerns.

Statistics such as **Contaminants in the indoor environment are more than 1,000 times more likely to be inhaled than outdoor air** (Levin, 2007) and can be **up to 10 times more polluted than outside air** (US EPA, 2001) have worked well to shock the Construction industry in to adopting continuous Mechanical Ventilation such as MVHR and MEV as standard.

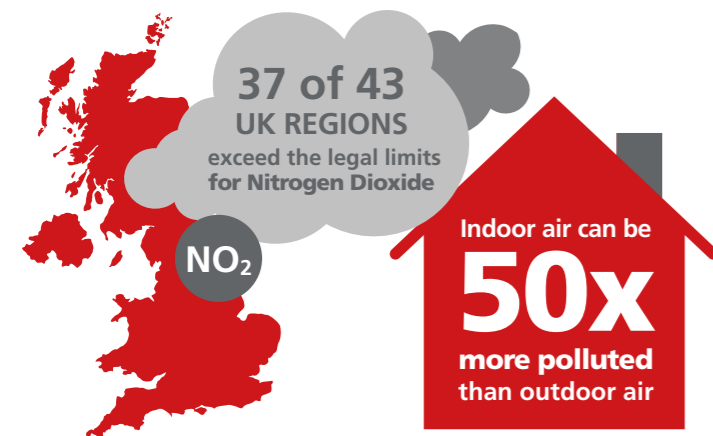

Overheating in new-build properties



MEV and MVHR systems are increasingly being installed into new properties.

As a cost-effective means of lowering Dwelling Emission Rates to gain points towards achieving a higher SAP rating (as listed in the Product Characteristics Database), many developers and specifiers are seeing the benefit of adopting a whole house ventilation system, whilst also being able to improve the indoor environment for their clients.

Mechanical Ventilation Products

When specifying or installing a ventilation system, consideration must be given to the total floor area, national Building Regulations, air permeability, occupancy levels, installation standards and ease of user operation and maintenance.

Select the most optimum system for your property and ensure your appliance's performance is maximised by installing the most suitable Domus duct system.



SYSTEM 3 Decentralised Mechanical Extract Ventilation (dMEV)

The highly efficient dMEV range offers continuous low level ventilation – to a single wet room, coupled with virtually silent operation.

Also known as System 3 in Approved Document F of the Building Regulations, decentralised Mechanical Extract Ventilation (dMEV) systems incorporate continuously running extract fans, designed to remove waste and moist air from a single wet room.

dMEV fans continuously extract the waste air at both low trickle or boost speeds, as determined by the homeowner through a range of control options. Replacement fresh air is then drawn into the dwelling via background ventilators located in the habitable rooms.

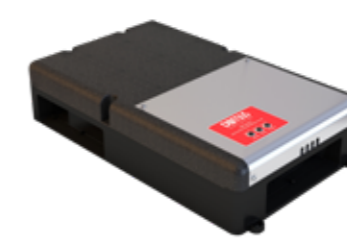

SYSTEM 3 Mechanical Extract Ventilation (MEV)

A continuous, effective and efficient means of maintaining the indoor air quality that you breathe and live in.

Also referred to as System 3 in Approved Document F of the Building Regulations, an MEV system consists of a centralised ventilation unit that continuously extracts waste, polluted and moist air from wet rooms and can be discreetly positioned in either a cupboard, utility room, ceiling or loft space.

An MEV system can be ducted throughout the dwelling and operated by the homeowner through a range of control options. Typically dual speed, MEV systems provide both low speed continuous trickle ventilation and high speed boost flow when required. Replacement fresh air is drawn into the dwelling through background ventilators i.e. air inlets, located in the living areas.



SYSTEM 4 Mechanical Ventilation with Heat Recovery (MVHR)

Helps to create a healthy and clean indoor air environment whilst reducing household energy consumption.

Also referred to as System 4 in Approved Document F of the Building Regulations, MVHR efficiently combines supply and extract ventilation into one centralised system.

As its primary function, waste, polluted and moist air is extracted from a dwelling's wet rooms via a duct system and is passed through a heat exchanger before being exhausted outside. Fresh incoming air is filtered and as an added benefit, pre-warmed via the heat exchanger and evenly distributed to the habitable rooms, thus reducing household energy consumption and the demand on existing heating systems.

The technology is most effective when installed in an air-tight dwelling as the effect is not compromised by external leakage.

Modular Construction... The Next Generation in Ventilation

The HRXE range is ideal for off-site modular construction. Prefabrication construction has been at the forefront when designing this range of MVHR systems; at just 507mm high they comply with the tight space restrictions and simple access required in Residential New-build today.



Controls located on the front panel make for simple commissioning and maintenance access



- ▶ The HRXE-AV Anti-Vibration tray is suitable for all models within the range and can be used in both floor and wall installation.
- ▶ It is perfect for application where transfer of sound is a concern.

System 3 Decentralised Mechanical Extract Ventilation (dMEV)

DME 100mm (4") Energy Efficient

Stylishly designed to discreetly complement modern interior design schemes, the DME100C from our Sapphire range offers exceptionally high levels of energy efficient performance and operates almost silently; ensuring homeowners are not disturbed whilst maintaining continuous and effective balanced ventilation.



Key features

- ▶ Provides very quiet levels of continuous ventilation to a single wet room
- ▶ Comply with Building Regulation requirements
- ▶ Stylish fascia to fit interior design scheme
- ▶ Very low SFP down to 0.30 (W/l/s)
- ▶ Suitable for bathroom, toilet, utility and kitchen
- ▶ Ideal for new-build and replacement

Dimensions

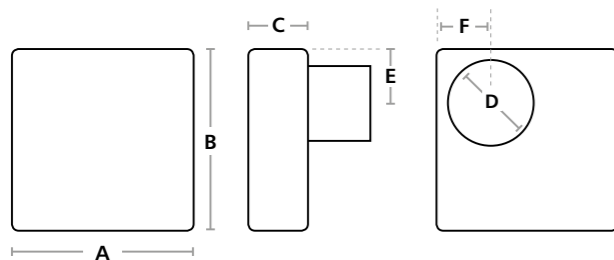

Measured in mm
 A: 170 C: 110 E: 72
 B: 170 D: 99 F: 69

Models	SELV	Timer	Humidistat
DME100C	•	•	•
DME100LVC	•	•	•

Technical Data	
Supply Frequency (Hz)	50
Weight (kg)	0.85
IP Rating	X4
Max Operating Temperature (°C)	40
Wall-Fit Hole Diameter (mm)	110
Max Airflow (l/s)	18.5
Max Airflow (m ³ /h)	66.6
Max Sound (dBA @ 3m)	38
Max Power (w)	8
Warranty	2 yrs

Specific Fan Power (W/l/s)	
Rooms	SFP (W/l/s)
In-room fan - kitchen	0.35
In-room fan - other wet room	0.45
Through-wall fan - kitchen	0.30
Through-wall fan - other wet room	0.38

Sound dB(A)@3m	Kitchen 34/OWR 25	Kitchen 34/OWR 25
Supply Frequency (Hz)	50	50
Weight (kg)	0.85	0.85
IP Rating	X4	X4
Max Operating Temperature (°C)	40	40
Wall-Fit Hole Diameter (mm)	110	110
Warranty	2 yrs	2 yrs

Performance

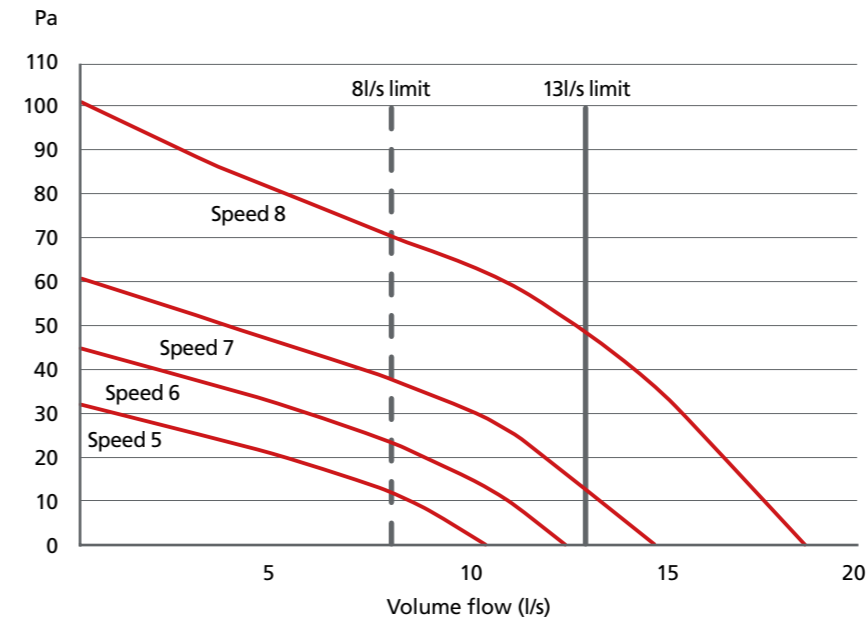

Speed	Air volume flowrate (l/s)
Speed 5	10.3
Speed 6	12.3
Speed 7	14.6
Speed 8	18.5

Consultant specification for DME100C & DME100LVC

The units shall be manufactured by Domus Ventilation.

PCDB listed for inclusion within (SAP) & the identifier for this product is Decentralised Mechanical Ventilation Equipment (dMEV).

The unit shall be capable of being surface mountable or Ceiling mounted. The fan fascia shall appear as a single smooth finish for discreet integration within the wet room. The unit shall have 2 speed settings - low or high & the range shall include low voltage, timer and humidistat options.

The DME100 range set at low speed (Trickle) shall be selectable from 4l/s to 7l/s. The DME100 range at high speed shall (boost) shall be selectable from 10l/s to 18l/s.

Maximum specific fan powers shall be achieved using the DME100 range in line with the following:

Unit noise level shall not exceed 34dBA @ 3m at maximum speed and 18dBA for other wet rooms (normal running).

The unit shall incorporate an injection moulded, centrifugal impeller. The impeller shall be directly driven by a low energy, high efficiency EC motor, fitted with sealed, self-lubricating ball bearings.

IPX4 rated.

Suitable for bathroom zone 1 applications.

Motors shall have locked rotor protection to prevent overheating in the event of fan failure.

Each unit is capable of being set to comply with new edition (2010).

Part F – ventilation building regulations for (System 3) continuous mechanical extract (MEV) and new edition (2010) Part L - conservation of fuel and power.

The unit will meet the requirements of Part F for the following installations:

Fan mounted within room with a maximum of 2m of rigid PVC ducting (Domus part number 1200-4)

2 off 90° bends (Domus part number 490)

1 off low resistance extract grille (Domus part number 4904).

Fan mounted through a wall with 350mm rigid PVC ducting (Domus Part Number 135-4) & 1 off external louvre (Domus part number 4904)

Unit can comply with BRE digest 398 under continuous mechanical extract ventilation.

Meets Specific Fan Power requirement in the 'Domestic Building Services Compliance Guide' (2010 edition).

The unit shall be designed for quietest operation to ensure occupant satisfaction. The unit shall incorporate electrical connections to allow for the unit's "boost" airflow to be triggered by switched live. The unit shall be supplied with a 2 year warranty; 1 year parts and labour, remaining year parts only.



CONTACT DOMUS VENTILATION FOR A FREE OF CHARGE MVHR AND MEV TECHNICAL DRAWING SERVICE!

Domus Ventilation have a dedicated, in-house Technical team offering a range of services from duct take-off's and estimations, to Revit MVHR and MEV drawings. You will be met with ongoing support throughout your project, from initial enquiry through to a detailed delivery plan which suits you.

And the best part is, these services are completely **free of charge!**

Send us your project details and receive:

- ▶ An assigned Estimator/Designer who will become your direct point of contact
- ▶ **FREE OF CHARGE** drawings available in AutoCAD or Revit
- ▶ A full Bill of Materials
- ▶ Scheduled, nation-wide delivery
- ▶ Ongoing technical support when our kit is on site



Mechanical Extract Ventilation, CMX-MULTI unit

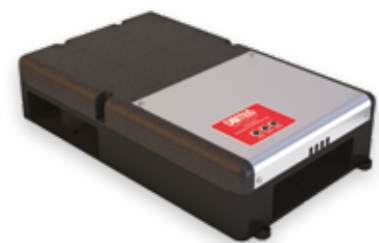

Mechanical Ventilation with Heat Recovery, HRXE unit



Domus Ventilation also offer BPEC approved facilities for installer training.

Enquire now for course dates at our 3 Professional Development Centres!



Controls Options

The Domus Ventilation range of control options are ideal for mechanical extract appliances designed for remote switch operation.



All products can be flush or surface mounted using a standard single pattress box.



Humidistat with Overrun Timer Switch

More sensitive than traditional humidistat controls, Intelligent Humidity Control (IHC) identifies a significant change in humidity. Timer adjustable between 2-25 minutes. **W89mm x H89mm x D54mm* 5 amps**

Code	ANC802A
------	---------

Humidistat with Overrun Timer & Pullcord Switch

More sensitive than traditional humidistat controls, Intelligent Humidity Control (IHC) identifies a significant change in humidity. Neon indicator and pull cord override. **W89mm x H89mm x D54mm* 5 amps**

Code	ANC808A
------	---------

Duct Mounted Humidistat with Remote Sensor and Overrun Timer Switch

More sensitive than traditional humidistat controls, Intelligent Humidity Control (IHC) identifies a significant change in humidity. Timer adjustable between 2-25 minutes. **W89mm x H89mm x D54mm* 5 amps**

Code	ANC846A
------	---------

PIR Switch with Overrun Timer Switch

Activates by detecting movement. Detection distance of up to 5 metres. Timer adjustable between 2-25 minutes. **W89mm x H89mm x D54mm* 5 amps**

Code	ANC813A
------	---------

Overrun Timer Switch

Adjustable time delay between 2-25 minutes after the light switch has been turned off. **W89mm x H89mm x D54mm* 5 amps**

Code	ANC108A
------	---------

Two Speed Rocker Switch

Provides two speed operation for twin speed fans. **W89mm x H89mm x D54mm* 5 amps**

Code	ANC812A
------	---------

Low/ Boost Switch

Branded switch that provides two speed options. **W87mm x H87mm x D30mm**

Code	ANC848A
------	---------

Low/ Boost Purge Switch

Branded switch that provides three speed options. **W87mm x H87mm x D30mm**

Code	ANC850A
------	---------

*Includes 35mm surface mounted pattress box (supplied).

Contact us:

Tel 03443 715 523 | vent.projects@domusventilation.co.uk | www.domusventilation.co.uk

**System 3
Mechanical Extract Ventilation (MEV)**

CMX-S

With an impressive airflow performance of up to 120l/s, the CMX-S is suitable for both Residential and Light Commercial applications. At just 125mm in depth, the CMX-S is one of the most versatile, easy to install and energy efficient MEV solutions available on the market.

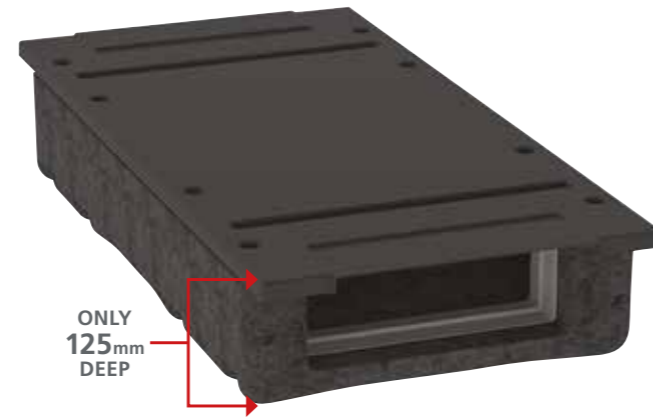

Key features

- ▶ High air flow performance up to 120l/s
- ▶ In-line ports enable straightforward duct connection
- ▶ Flexible home owner control (3 speed options)

Dimensions (mm)

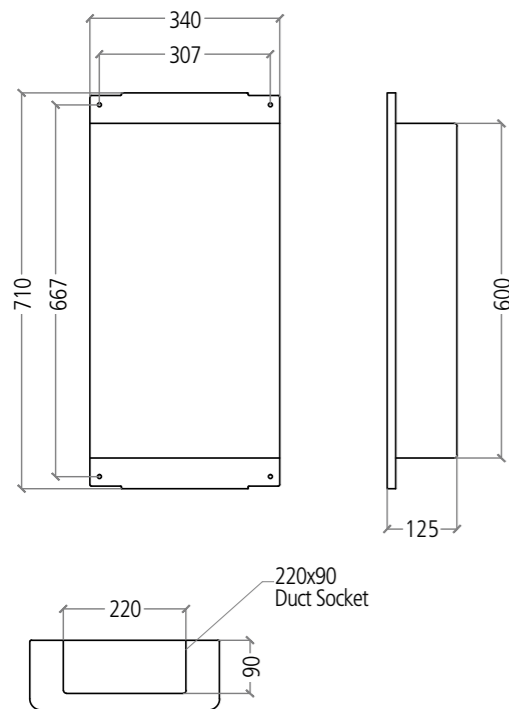

Codes	Description	Unit
CMX-S	Domus CMX-S Mechanical Extract Ventilation Unit	1

Technical data	
Max Extract Volume (m ³ /h)	430
Max Extract Volume (l/s)	120
Max Pressure (Pa)	650
Max Power (W)	83
Supply Frequency (Hz)	50
Max Sound dB(A) @ 3m	51
Socket Size (mm)	220 x 90
Insulation Class	1
Weight (kg)	3.25
Max Operating Temperature (°C)	40

Installation

- ▶ Floor area up to 275m²
- ▶ Flexible installation. Can be fitted horizontally or vertically:
 - Inside a kitchen cupboard or utility room
 - Direct to a ceiling or in a loft space
 - Within a joist space

Performance

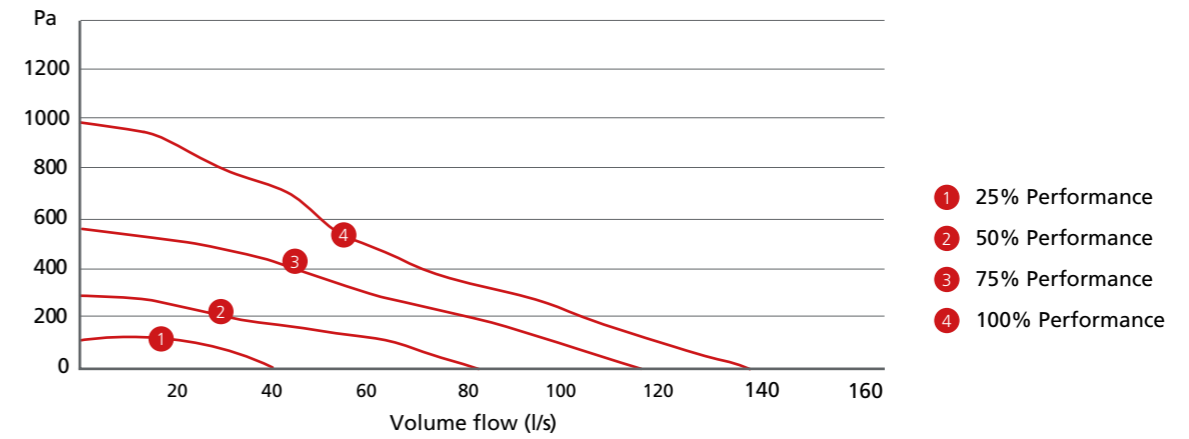

CMX-S PRODUCT CHARACTERISTICS DATABASE (SAP 2012)

	Specific Fan Power (W/l/s)
Kitchen + 1 wet room	0.24
Kitchen + 2 wet rooms	0.25
Kitchen + 3 wet rooms	0.29
Kitchen + 4 wet rooms	0.35
Kitchen + 5 wet rooms	0.43
Kitchen + 6 wet rooms	0.54

BREAKOUT SOUND PERFORMANCE

Speed Setting	Sound Power Levels dB re 1pW								Sound Pressure (dB(A) @ 3m)
	63	125	250	500	1K	2K	40K	8K	
25%	43	41	37	42	41	30	23	24	27
50%	49	53	54	58	57	51	41	31	43
75%	68	61	62	66	65	61	53	45	52
100%	71	64	62	69	68	64	57	49	55

The breakout case-radiated dBA values are given for Hemispherical free field radiation at 3m – to obtain the Spherical radiated data, subtract 3 dBA.

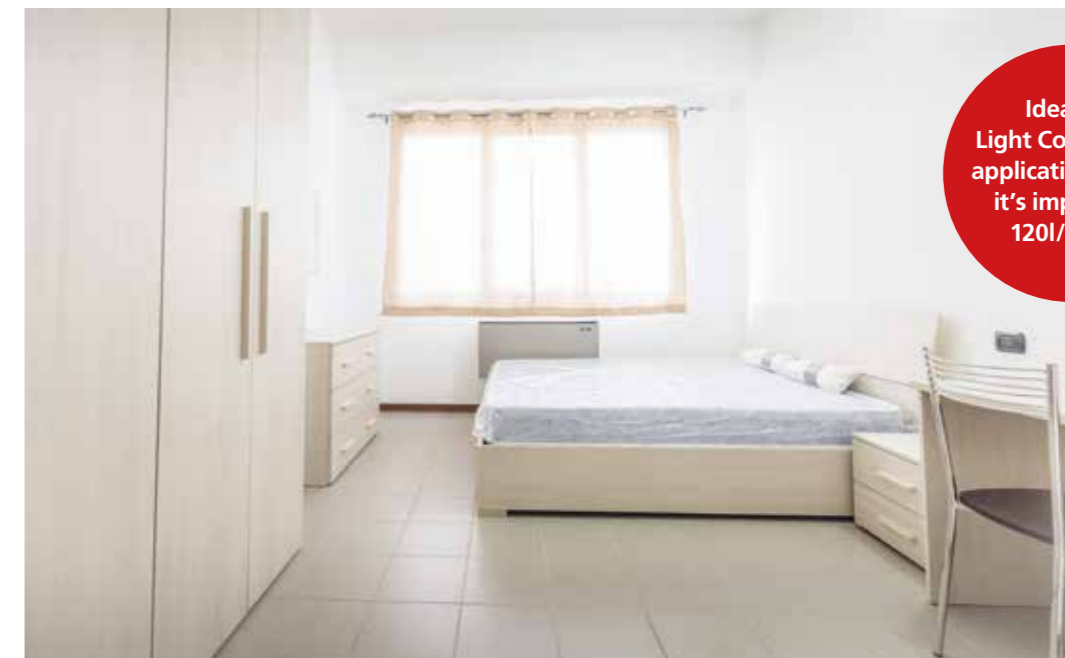

Ideal for Light Commercial application due to its impressive 120l/s duty

Consultant Specification for CMX-S

The unit shall be designed specifically for incorporation within a system designed to comply with the requirements of Part F Building Regulations. Ducting and grilles forming part of the system are specified elsewhere. Unit shall be CMX-S as manufactured by Domus Ventilation and shall be listed on the SAP PCDB.

The unit shall be manufactured by a BSI Registered Firm with ISO 9000 certification. The unit's casing shall be of ABS, moulded plastic and EPP moulded foam. The unit shall incorporate 4 mounting hole points for mounting to a rigid surface. When installed the unit shall not project any more than 125mm from the surface onto which it is installed. Air discharge from the unit shall be via a tapered rectangular spigot for easy connection to ducting. The unit shall be capable of a single inlet format. The unit casing shall have the facility to allow the connection, via tapered air inlet spigots supplied with one 220mm x 90mm spigot.

The unit shall be constructed with one removable panel allowing full maintenance access. The unit shall incorporate a fully speed adjustable (note: stepped speed control shall not be acceptable) low energy, high efficiency EC fan/motor assembly with sealed for life bearings designed to operate continuously at a pre-set "background" design airflow rate with the ability to increase to a pre-set "boost" or a pre-set "Purge" design airflow rate as and when required. It shall operate up to an ambient temperature of 40°C and be fitted with a locked rotor protection device.

The impeller should be a centrifugal backward curved type, dynamically balanced and mounted directly onto the motor. The unit shall incorporate electrical connections to allow for the unit's "boost" airflow to be triggered by a switched live signal, 230V.

The CMX-S unit shall be offered with a 2 year warranty; 1 year parts and labour, remaining years parts only.

System 3 Mechanical Extract Ventilation (MEV)

CMX-MULTI

The CMX-MULTI showcases the **BEST SFP** on the market whilst maintaining a unique 125mm depth for simple, flexible installation.

Aimed at the Residential market its shape and size conform with New-Build restrictions, whilst also making it ideal for retro-fit projects due to direct duct runs and wall or ceiling void fixings. Quiet running, whilst comfortably providing impressive airflow rates and with a choice of models with and without integral humidistat, the CMX-MULTI range provide the solution in Mechanical Extract Ventilation.



Key features

- ▶ SFP down to 0.14 (W/l/s) at K+1
- ▶ CMX-MULTI-H has integral humidistat, ideal for specification works
- ▶ 3 inlet spigots for simplified multi-room extraction
- ▶ 204x60mm spigots allowing direct duct runs from the unit, saving time and money on site

Dimensions (mm)

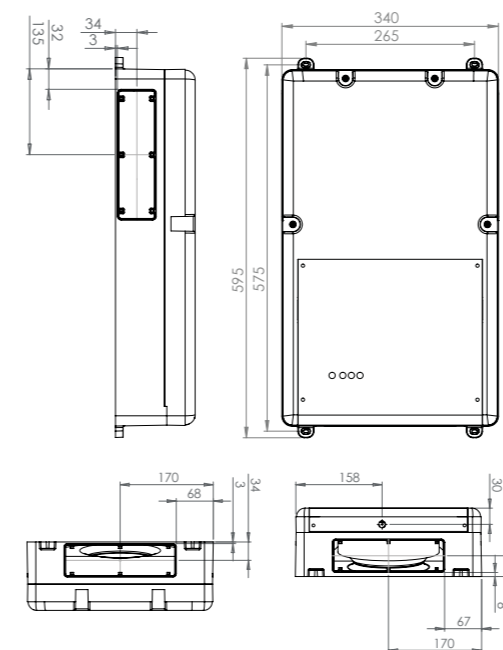

Slimmest and lightest MEV on the UK Market!

Codes	Description	Unit
CMX-MULTI	Domus CMX-MULTI Mechanical Extract Ventilation Unit	1
CMX-MULTI-H	Domus CMX-MULTI Mechanical Extract Ventilation Unit with integral Humidstat	1

Technical data	
Max Extract Volume (m³/h)	409
Max Extract Volume (l/s)	113.5
Max Pressure (Pa)	460
Max Power (W)	63.5
Supply Frequency (Hz)	50
Max Sound dB(A) @ 3m	45
Socket Size (mm)	204 x 60
Insulation Class	1
Weight (kg)	3.1
Max Operating Temperature (°C)	40



Performance – 3 open outlets

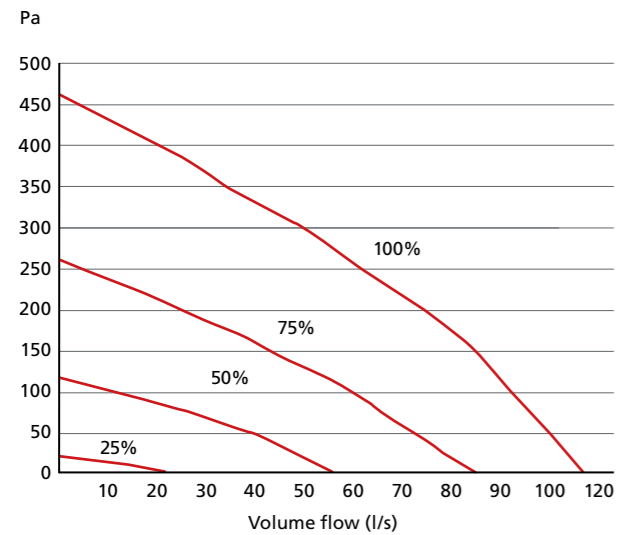

Sound performance

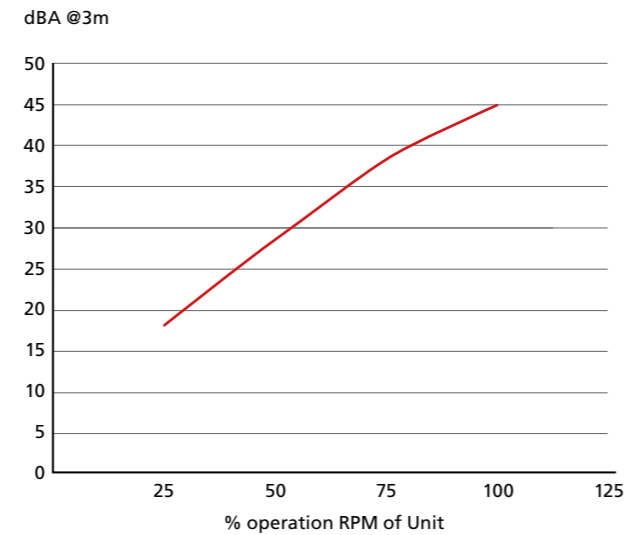

Consultant Specification for CMX-MULTI/CMX-MULTI-H

The unit shall be designed specifically for incorporation within a system designed to comply with the requirements of Part F Building Regulations. Ducting and grilles forming part of the system are specified elsewhere. Units shall be CMX-MULTI as manufactured by Domus Ventilation and shall be listed on the SAP PCDB.

The unit shall be manufactured by a BSI Registered Firm with ISO 9000 certification. The unit's casing shall be of ABS, moulded plastic and EPP moulded foam.

The unit shall incorporate mounting hole points located at each corner for mounting to a rigid surface. When installed the unit shall not project any more than 125mm from the surface onto which it is installed. Air discharge from the unit shall be via a tapered rectangular spigot for easy connection to ducting.

The unit shall be capable of a three-inlet format. The unit casing shall have the facility to allow the connection, via tapered air inlet spigots supplied with three 204mm x 60mm spigots.

The unit shall be constructed with one removable panel allowing full maintenance access, but it is not required to be removed for installation as the unit is supplied with a flying lead. The unit shall incorporate a fully speed adjustable (note: stepped speed control shall not be acceptable) low energy, high efficiency DC fan/motor assembly with sealed for life bearings designed to operate continuously at a pre-set "background" design airflow rate with the ability to increase to a pre-set "boost" or a pre-set "Purge" design airflow rate as and when required. It shall operate up to an ambient temperature of 40°C and be fitted with a locked rotor protection device.

The impeller should be a centrifugal backward curved type, dynamically balanced and mounted directly onto the motor. The unit shall incorporate electrical connections to allow for the units "boost" airflow to be triggered by a switched live signal, 230V. The CMX-MULTI-H has an integral humidity sensor which operates the "boost" function. Both the CMX-MULTI & CMX-MULTI-H shall be offered with a 2 year warranty; 1 year parts and labour, remaining years parts only.

Performance – CMX-MULTI 3 open inlets

Fan speed	Test	Frequency/Hz								Breakout (dB(A) @ 3m)	LwA
		63	125	250	500	1K	2K	4K	8K		
		Sound Power Levels dB re 1pW									
25%	Open inlet	48	48	33	28	34	28	13	13	-	38
25%	Open inlet	46	46	38	36	33	29	22	21	-	39
25%	Breakout	46	52	35	30	27	19	6	2	17	37
50%	Open inlet	48	49	55	49	53	48	38	29	-	56
50%	Open inlet	46	47	58	54	54	52	42	32	-	58
50%	Breakout	40	49	53	48	42	37	25	13	28	49
75%	Open inlet	54	58	63	60	63	59	52	44	-	66
75%	Open inlet	49	53	66	69	66	65	57	48	-	71
75%	Breakout	49	59	61	57	53	49	40	28	38	59
100%	Open inlet	61	55	66	70	69	66	61	54	-	73
100%	Open inlet	56	56	69	75	72	71	65	57	-	77
100%	Breakout	56	59	64	65	59	56	49	37	45	65

CMX-MULTI Product Characteristics Database (SAP 2012)

Kitchen + n wet rooms	Power (W)	Flow (l/s)	SFP (W/l/s)
Kitchen + 1 wet room	2.89	21	0.14
Kitchen + 2 wet rooms	4.5	29	0.16
Kitchen + 3 wet rooms	7.22	37	0.20
Kitchen + 4 wet rooms	11.13	45	0.24
Kitchen + 5 wet rooms	16.3	53	0.31
Kitchen + 6 wet rooms	22.42	61	0.37

System 4 Mechanical Ventilation with Heat Recovery (MVHR)

HRXE

All HRXE models have been designed with 100% automatic bypass, as listed on the SAP Product Characteristics Database (PCDB).

The HRXE range operate by continuously extracting moisture-laden air from 'wet' rooms within the property and at the same time drawing in fresh supply air from outside.

The heat from the extracted stale air is recovered via a heat exchanger inside the heat recovery unit which becomes tempered and filtered, before supplied in to the habitable rooms, creating comfortable and well ventilated homes.

Key features

- ▶ The heat exchanger block within these units can recover up to 90% of the normally wasted heat. The two independent fans have full-speed control for background and boost ventilation rates.
- ▶ All models have a 100% automatic bypass function, utilised in warmer months. By entering in to Bypass mode the HRXE unit no longer recovers heat from extracted air and simply allows cooler air from outside to pass through its G3 filters and enter the home via the supply valves.
- ▶ Due to its intelligent and smart design, there will be no reduction in airflow when operating in bypass mode resulting in enhanced performance.
- ▶ Weight: 20kg

Accessories

Code	Description
HRXE-AV	Anti-Vibration tray suitable for all HRXE models
397	Condensate Drain Kit for all HRXE models
SPR428	Replacement filters (pair)



Codes	Description
HRXE	Standard unit with 100% bypass
HRXE-H	Standard unit with 100% bypass and integral humidistat
HRXE-OP	Opposite handed unit with 100% bypass
HRXE-OPH	Opposite handed unit with 100% bypass and integral humidistat

Dimensions (mm)

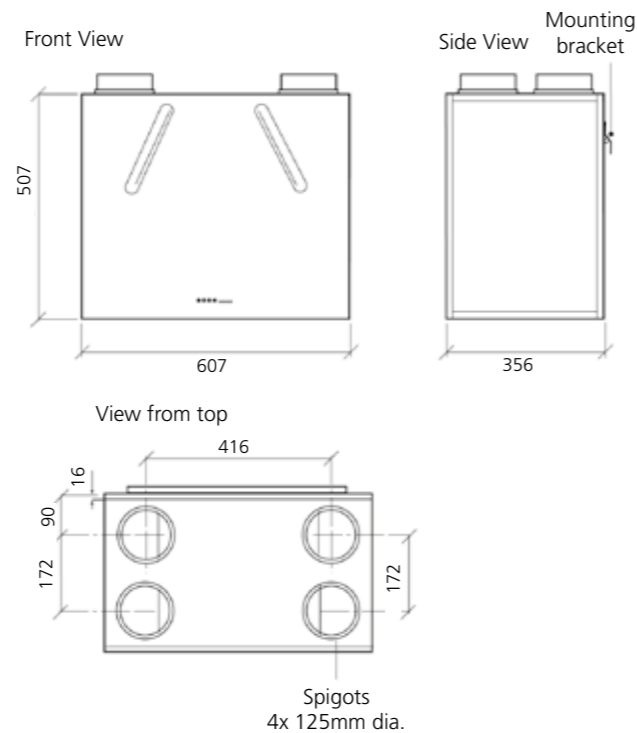

Performance

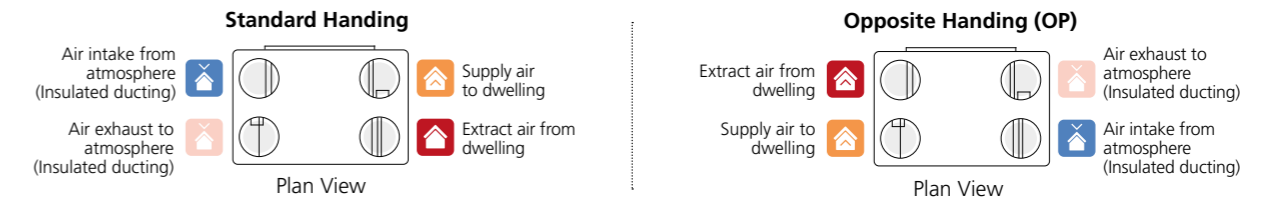
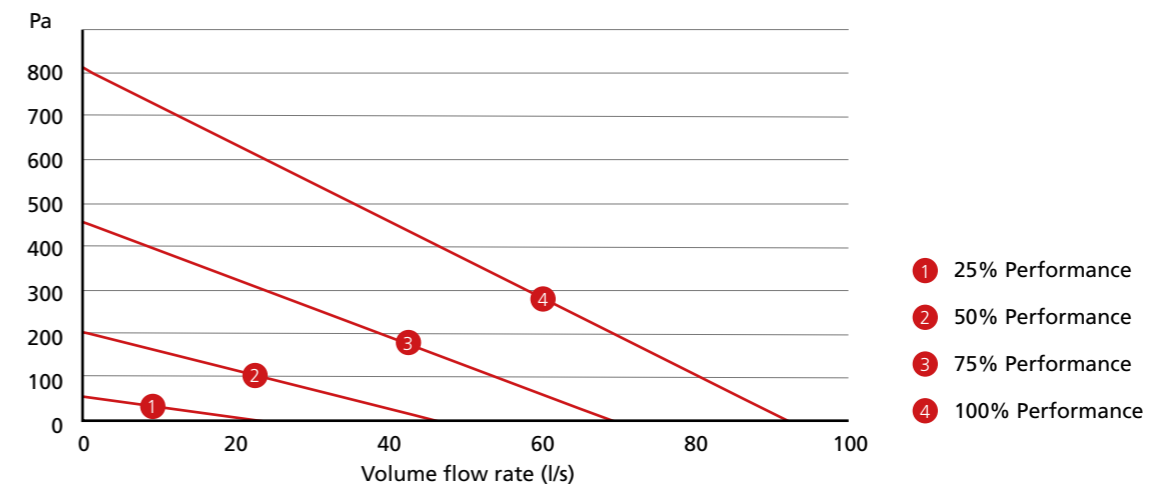

HRXE PRODUCT CHARACTERISTICS DATABASE (SAP 2012)			
	Specific Fan Power (W/l/s)	Heat Exchange Efficiency (%)	Energy Saving Trust Best Practice Compliant
Kitchen + 1 wet room	0.57	90%	Yes
Kitchen + 2 wet rooms	0.64	88%	Yes
Kitchen + 3 wet rooms	0.81	87%	Yes
Kitchen + 4 wet rooms	1.05	86%	Yes
Kitchen + 5 wet rooms	1.29	86%	Yes

BREAKOUT SOUND PERFORMANCE											
Curve	Maximum power consumption (Watts)		Sound Power Levels dB re 1pW								Breakout (dB(A) @ 3m)
			63	125	250	500	1000	2000	4000	8000	
1	7	Open inlet	38	31	27	23	<16	<16	<16	<16	
		Open outlet	38	34	31	31	22	<16	<16	<16	
		Breakout	37	31	24	20	<16	<16	<16	<16	<16
2	19	Open inlet	39	38	48	40	35	29	16	<16	
		Open outlet	48	54	53	55	49	47	35	24	
		Breakout	43	48	44	42	34	29	<16	<16	24
3	69	Open inlet	44	47	57	50	45	41	30	21	
		Open outlet	55	63	63	65	60	59	49	40	
		Breakout	56	57	53	52	44	40	28	18	34
4	155	Open inlet	48	52	59	55	50	46	35	27	
		Open outlet	60	67	69	69	64	64	54	46	
		Breakout	59	60	58	59	49	46	35	27	40

The maximum power consumption shown above (Watts) is consumed on units running continuously, not taking into account any heat recovery saving and based on SAP Product Characteristic Database (PCDB) testing. The breakout case-radiated dBA values are given for Hemispherical free field radiation at 3m - to obtain the Spherical radiated data, subtract 3 dBA.

Consultant Specification for HRXE

Specification

The unit shall be fully insulated providing excellent thermal and acoustic characteristics and shall be complete with a multi-plate, counter-flow, high-efficiency heat exchanger block, with a thermal efficiency of up to 90%. The heat exchanger shall be protected by G3 grade filters on fresh air inlet and system extract. The heat exchanger and filters shall be accessible via the front access panel, enabling quick and easy maintenance.

The unit shall have low energy, high-efficiency EC fan/motor assemblies with sealed for life bearings, the impellers shall be backward-curved centrifugal type. The motors shall be suitable for an ambient temperature of 40°C.

The unit shall be supplied complete with an insulated condensate drip tray and 21.5mm drain connection.

The unit shall be suitable for 125mm circular ducting.

Note: The unit is also available in opposite handed format, refer to spigot configuration for set up.

The breakout noise level and power requirements shall be as detailed by the unit manufacturer and in accordance with the ventilation equipment schedule.

Units shall be HRXE or HRXE-H as manufactured by Domus Ventilation and shall be listed on the SAP PCDB.

HRXE-OP and HRXE-OP-H are opposite handed assemblies compliant as per standard handed versions listed in SAP PCDB.

Operation

The supply and extract system shall be positioned as indicated on the drawings and shall be in accordance with the particular fan schedule in the specification.

The combined supply and extract with heat recovery unit shall supply filtered fresh air to each of the habitable rooms and moisture-laden air shall be extracted from all wet areas, e.g. bathroom, en suite, w.c, kitchen, utility rooms etc. The supply air shall be pre-heated by the warm extract air via the integrated counter-flow heat exchanger element. The extracted air shall also be filtered before it reaches the heat exchanger block.

The ventilation unit shall vary its speed and therefore the ventilation rate, as it receives signals from one of the following:

Switched live signal from light/remote switches. When signals are received, the fan shall alter its speed to adjustable, normal and boost rates. The unit shall have the facility to commission the supply and extract fans independently on minimum speed (continuous background ventilation) and boost speed via inbuilt minimum and maximum speed adjustment. The fans shall have infinitely variable speed control.

Integral Automatic HX Bypass with no reduction in airflow

The bypass damper shall open automatically via a wax actuator, allowing the air to bypass the heat exchanger to deliver fresh filtered air during the warmer months.

The automatic bypass diverts 100% airflow around the heat exchanger with no reduction in airflow as independently tested by the BRE.

The integral humidity sensor incorporated within the extract fan chamber will automatically boost both the extract and supply fan, to the commissioned boost speed, when the humidity level exceeds that set by the front panel mounted adjustment potentiometer.

The integral humidity sensor incorporated within the extract fan chamber will automatically boost both the extract and supply fan, to the commissioned boost speed, when the humidity level exceeds that set by the front panel mounted adjustment potentiometer.

Control Options

All versions shall have the following functions integrally mounted within the fan unit on a purpose made PCB, all such components are pre-wired and factory fitted by the manufacturer:

- ▶ Independent control of background supply and extract flow rates
- ▶ Independent control of boost speed supply and extract flow rates
- ▶ Integral heat exchanger frost protection
- ▶ Fan failure indication
- ▶ Integral S/L terminal for boost from remote switch, e.g. light switch
- ▶ Additional S/L terminal for 100% boost speed from remote switch, e.g. plate switch
- ▶ Discreet daily run monitor
- ▶ Indication and controls – The unit shall have clear LED visual indication for maintenance, servicing and operation mode, i.e. HX bypass, frost protection

System 4 Mechanical Ventilation with Heat Recovery (MVHR)

HRX2D

Ideal for larger developments, the HRX2D is a powerful yet highly efficient MVHR unit. Operation is automated with an integral humidistat to boost performance if necessary. The HRX2D comes complete with Domus Ventilation's unique Bluebrain controller which is used to commission the system, but also allows home-owner management of system operation with settings such as Holiday Mode and a warning for filter replacement.

Key features

- ▶ Extremely low Specific Fan Power (SFP) down to 0.57 (W/l/s)
- ▶ Bluebrain control optimises the unit's functionality and allows for quick and easy commissioning through simple speed adjustment buttons
- ▶ High heat exchange efficiency up to 94%
- ▶ Very quiet in operation, down to 35dB(A)
- ▶ Effectively extracts up to 113l/s at 150 Pa

Dimensions (mm)

Weight: 20kg

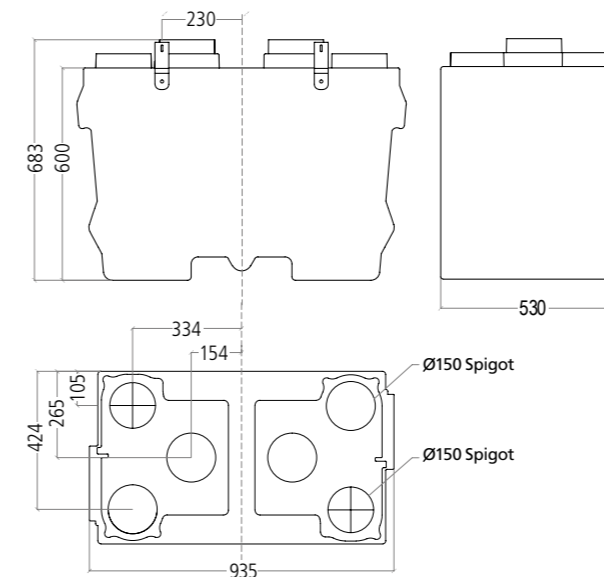

Code	Description	Unit depth	Thermal (Summer) Bypass
HRX2D	Domus HRXD Mechanical Ventilation with Heat Recovery Unit	530mm	✓

Accessories

Code	Description
297	Condensate Drain
HRX2C-AF	Air Filters
HRX2-CK1	Hose Connection Kit (included)
AQHC-CC8	8 Metre Data Cable (not included)

Centralised mechanical systems are fast becoming the preferred method of ventilation in the UK

Performance

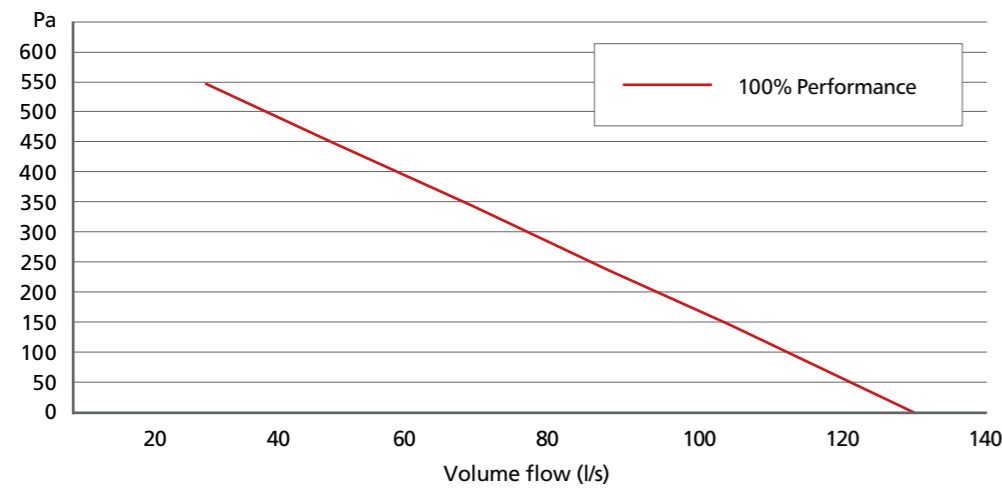

HRX2D PRODUCT CHARACTERISTICS DATABASE (SAP 2012)				
	Thermal Bypass	Specific Fan Power (W/l/s)	Air Flow (l/s)	Heat Exchange Efficiency (%)
Kitchen + 1 wet room	✓	0.61	21	94
Kitchen + 2 wet rooms	✓	0.57	29	94
Kitchen + 3 wet rooms	✓	0.62	37	92
Kitchen + 4 wet rooms	✓	0.70	45	92
Kitchen + 5 wet rooms	✓	0.82	53	91
Kitchen + 6 wet rooms	✓	0.98	61	90
Kitchen + 7 wet rooms	✓	1.15	69	90

BREAKOUT SOUND PERFORMANCE								
Speed Setting	Sound Power Levels dB re 1pW							Sound Pressure (dB(A) @ 3m)
	125	250	500	1000	2000	4000	8000	
25%	34	31	27	23	20	19	25	10
50%	45	43	40	36	30	20	25	21
75%	49	61	51	47	42	31	26	33
100%	53	62	58	54	50	41	30	39

INDUCT SUPPLY SOUND PERFORMANCE								
Speed Setting	Sound Power Levels dB re 1pW							Sound Pressure (dB(A) @ 3m)
	125	250	500	1000	2000	4000	8000	
25%	49	42	38	28	22	20	26	26
50%	61	56	52	44	38	24	26	26
75%	65	68	63	56	51	39	31	31
100%	70	78	71	64	60	50	42	42

INDUCT EXTRACT SOUND PERFORMANCE								
Speed Setting	Sound Power Levels dB re 1pW							Sound Pressure (dB(A) @ 3m)
	125	250	500	1000	2000	4000	8000	
25%	46	37	27	18	17	19	25	25
50%	53	49	38	28	22	20	25	25
75%	55	61	51	39	33	22	25	25
100%	59	68	55	48	41	31	27	27

The breakout case-radiated dBA values are given for Hemispherical free field radiation at 3m - to obtain the Spherical radiated data, subtract 3 dBA.

Consultant Specification for HRX2D

Specification

The unit shall be fully insulated providing excellent thermal and acoustic characteristics and shall be complete with a multi-plate, counter-flow, high-efficiency heat exchanger block; with a thermal efficiency of up to 94%. The heat exchanger shall be protected by G3 grade filters at fresh air inlet and system extract.

The heat exchanger filters shall be accessible via the front access panel, enabling quick and easy maintenance.

The unit shall have low energy, high-efficiency EC fan/motor assemblies with sealed for life bearings; the impellers shall be backward-curved centrifugal type. The motors shall be suitable for an ambient temperature of 40°C. The unit shall be supplied complete with a condensate drip tray. The unit shall be suitable for 150mm circular ducting. The breakout noise level and power requirements shall be as detailed by the unit manufacturer and in accordance with the ventilation equipment schedule.

Units shall be HRX2D as manufactured by Domus Ventilation and shall be listed on the SAP PCDB.

Operation

The supply and extract system shall be positioned as indicated on the drawings and shall be in accordance with the fan schedule in the specification.

The combined supply and extract with heat recovery unit shall supply filtered fresh air to each of the habitable rooms and moisture-laden air shall be extracted from all wet areas, e.g. bathroom, ensuite, kitchen, utility rooms etc. The supply air shall be pre-heated by the warm extract air via the integrated counter-flow heat exchanger element. The extracted air shall also be filtered before it reaches the heat exchanger block. The ventilation unit shall vary its speed and therefore the ventilation rate, as it receives signals from one of the following:

Switched live signal from light/remote switches via the Bluebrain Controller. When signals are received, the fan shall alter its speed to adjustable, normal and boost rates. The unit shall have the facility to commission the supply and extract fans independently on minimum speed (continuous background ventilation) and boost speed via inbuilt minimum and maximum speed adjustment. The fans shall have infinitely variable speed control.

Integral Automatic HX Bypass with no reduction in airflow

The bypass damper shall open automatically via a wax actuator, allowing the air to bypass the heat exchanger to deliver fresh filtered air during the warmer months. The automatic bypass diverts 100% airflow around the heat exchanger with no reduction in airflow as independently tested by the BRE.

Integral Humidity Sensor

The integral humidity sensor incorporated within the extract fan chamber will automatically boost both the extract and supply fan, to the commissioned boost speed, when the humidity level exceeds that set by the Bluebrain Controller.

Control Options

The HRX2D shall have the following functions integrally mounted within the separate fan wiring centre and controlled by the Bluebrain control Panel, which is

- ▶ Independent control of background supply and extract flow rates
- ▶ Independent control of boost speed supply and extract flow rates
- ▶ Integral heat exchanger frost protection
- ▶ Fan failure indication
- ▶ Integral S/L terminal for boost from remote switch, e.g. light switch
- ▶ Additional S/L terminal for 100% boost speed from remote switch, e.g. plate switch
- ▶ Discreet daily run monitor
- ▶ Indication and controls – The unit shall have clear LCD visual indication for maintenance, servicing and operation mode, i.e. HX bypass, frost protection

Bluebrain Control Panel

The controller comes complete with commissioning and end user functions. The display will be a 2.75" LCD display and will remain on standby until such time a control button is engaged.

The initial display will show the MVHR system status as listed below:

- ▶ Current fan speed
- ▶ Current indoor/outside temperature
- ▶ Indicate when the Summer bypass is activated
- ▶ Indicate when frost protection is activated
- ▶ Indicate when the filters require cleaning/changing

The unit shall come with a 2 year warranty which starts from the day of delivery.

System 4 Mechanical Ventilation with Heat Recovery (MVHR)

HRX-aQ

The most compact and intelligent MVHR ceiling unit on the market. HRX-aQ models enable contractors to deliver quick installation of a unique ventilation system; complete with Bluebrain controller.



Key features

- ▶ Specific Fan Power (SFP) down to 0.72(W/l/s)
- ▶ Bluebrain control optimises the unit's functionality and allows for quick and easy commissioning through simple speed adjustment buttons
- ▶ High heat exchange efficiency up to 87%
- ▶ Extremely quiet in operation, 24dB(A)
- ▶ Compact and lightweight – weighs 7.9kg and measures 199mm in depth
- ▶ Effectively extract up to 30l/s at boost (for a kitchen and two wet rooms)

Dimensions (mm)

Weight: 7.9kg

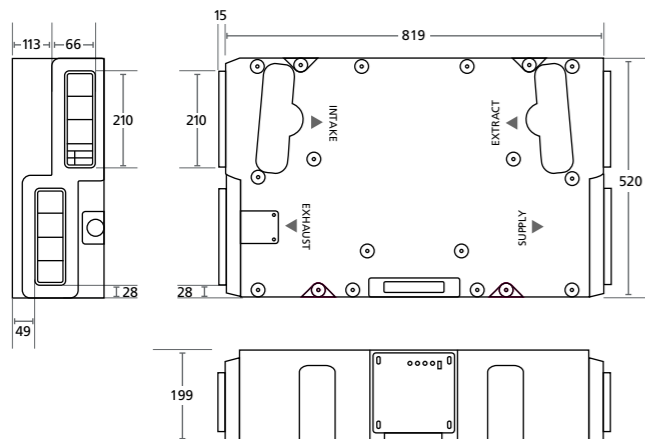

Ideal for restrictive application such as ceiling voids or tight spaces

Codes	Description	Unit depth	Thermal (Summer) Bypass
AQH200-S	Void Mounted MVHR unit	199mm	
AQH200-B	Void Mounted MVHR unit bypass	199mm	✓

Codes	Accessories
297	Condensate Drain (not included)
AQHC-CC8	8 metre data cable (not included)
SPR442	Replacement filters for AQH200-B & AQH200-S units (pair)

Sound performance

AQH200-S

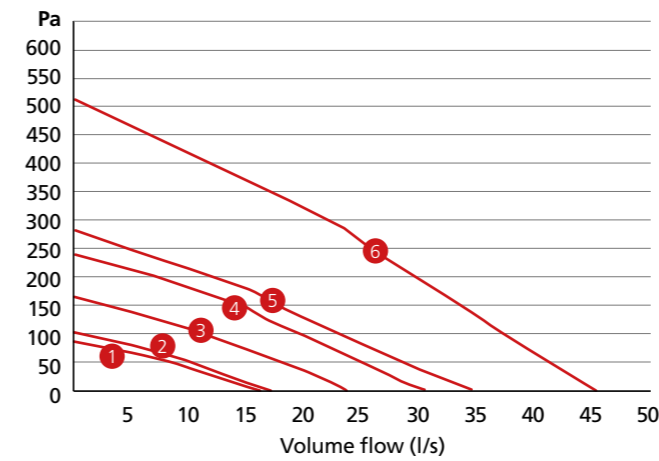

AQH200-B

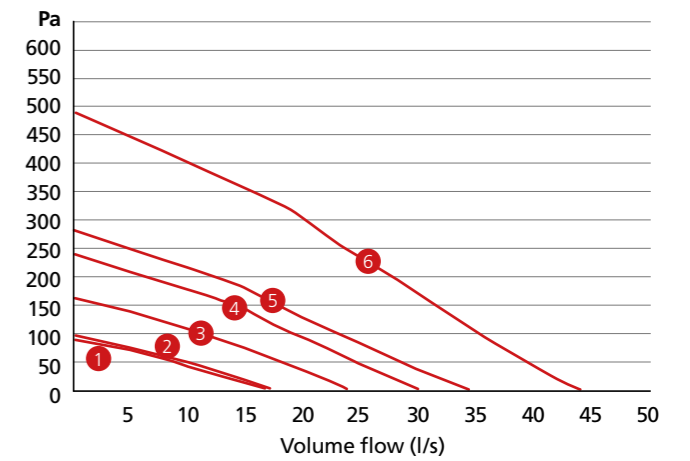

- ① 30% Performance
- ② 33% Performance
- ③ 50% Performance
- ④ 60% Performance
- ⑤ 70% Performance
- ⑥ 100% Performance

HRX-aQ PRODUCT CHARACTERISTICS DATABASE (SAP 2012)			
	Thermal Bypass	Specific Fan Power (W/l/s)	Heat Exchange Efficiency (%)
AQH200-S			
Kitchen + 1 wet room	✗	0.72	87
Kitchen + 2 wet rooms	✗	0.88	84
AQH200-B			
Kitchen + 1 wet room	✓	0.75	83
Kitchen + 2 wet rooms	✓	0.95	81

BREAKOUT SOUND PERFORMANCE												
Speed Setting	Sound Power Levels dB re 1pW								Sound Pressure (dB(A) @ 3m)	Flow Rate (l/s)	Pressure (Pa)	Power (W)
	63	125	250	500	1000	2000	4000	8000				
AQH200-S												
100%	46	55	54	62	53	44	41	34	44	38	96	52
70%	40	50	54	50	42	39	34	21	34	27	47	22
50%	*	46	53	43	38	37	31	12	30	21	28	15
33%	*	41	46	39	34	35	26	6	25	15	16	10
AQH200-B												
100%	49	57	55	59	51	44	42	33	41	37	83	52
70%	43	49	55	53	41	36	32	21	35	27	40	20
50%	48	44	53	46	36	30	24	11	30	21	23	15
33%	46	40	47	40	32	27	17	3	24	15	13	10

The breakout case-radiated dBA values are given for Hemispherical free field radiation at 3m - to obtain the Spherical radiated data, subtract 3 dBA. *Noise not normally heard by the human ear.

Consultant Specification for AQH200-B and AQH200-S

Specification

The unit shall be fully insulated providing excellent thermal and acoustic characteristics and shall be complete with a multi-plate, counter-flow, high-efficiency heat exchanger block, with a thermal efficiency of up to 88%. The heat exchanger shall be protected by G3 grade filters at fresh air inlet and system extract.

The heat exchanger filters shall be accessible via the front access panel, enabling quick and easy maintenance.

The unit shall have low energy, high-efficiency EC fan/motor assemblies with sealed for life bearings, the impellers shall be backward-curved centrifugal type. The motors shall be suitable for an ambient temperature of 40°C. The unit shall be supplied complete with a condensate drip tray. The unit shall be suitable for 204mm x 60mm rectangular ducting. The breakout noise level and power requirements shall be as detailed by the unit manufacturer and in accordance with the ventilation equipment schedule.

Units shall be AQH200-S and AQH200-B as manufactured by Domus Ventilation and shall be listed on the SAP PCDB.

Operation

The supply and extract system shall be positioned as indicated on the drawings and shall be in accordance with the fan schedule in the specification.

The combined supply and extract with heat recovery unit shall supply filtered fresh air to each of the habitable rooms and moisture-laden air shall be extracted from all wet areas, e.g. bathroom, en suite, kitchen, utility rooms etc. The supply air shall be pre-heated by the warm extract air via the integrated counter-flow heat exchanger element. The extracted air shall also be filtered before it reaches the heat exchanger block. The ventilation unit shall vary its speed and therefore the ventilation rate, as it receives signals from one of the following:

Switched live signal from light/remote switches via the Bluebrain Controller. When signals are received, the fan shall alter its speed to adjustable, normal and boost rates. The unit shall have the facility to commission the supply and extract fans independently on minimum speed (continuous background ventilation) and boost speed via inbuilt minimum and maximum speed adjustment. The fans shall have infinitely variable speed control.

Integral Automatic Bypass (AQH200-B only)

The bypass damper shall open automatically via a wax actuator, allowing the air to bypass the heat exchanger to deliver fresh filtered air during the warmer months. The automatic bypass diverts 100% airflow around the heat exchanger with no reduction in airflow as independently tested by the BRE.

Integral Humidity Sensor

The integral humidity sensor incorporated within the extract fan chamber will automatically boost both the extract and supply fan, to the commissioned boost speed, when the humidity level exceeds that set by the Bluebrain Controller.

Control Options

The AQH200-S and AQH200-B shall have the following functions integrally mounted within the separate fan wiring centre and controlled by the Bluebrain Control Panel, which is:

- ▶ Independent control of background supply and extract flow rates
- ▶ Independent control of boost speed supply and extract flow rates
- ▶ Integral heat exchanger frost protection
- ▶ Fan failure indication
- ▶ Integral S/L terminal for boost from remote switch, e.g. light switch
- ▶ Additional S/L terminal for 100% boost speed from remote switch, e.g. plate switch
- ▶ Discreet daily run monitor
- ▶ Indication and controls – The unit shall have clear LCD visual indication for maintenance, servicing and operation mode, i.e. HX bypass, frost protection

Bluebrain Control Panel

The controller comes complete with commissioning and end user functions. The display will be a 2.75" LCD display and will remain on standby until such time a control button is engaged.

The initial display will show the MVHR system status as listed below:

- ▶ Current fan speed
- ▶ Current indoor/outside temperature
- ▶ Indicate when the Summer bypass is activated
- ▶ Indicate when frost protection is activated
- ▶ Indicate when the filters require cleaning/changing

The unit shall come with a 2 year warranty which starts from the day of delivery.

Supporting your projects FROM CONCEPT TO COMPLETION

- ▶ Technical Support
- ▶ Nationwide sale coverage
- ▶ National distribution
- ▶ After sales support



NOX-FILT

The **NOX-FILT** range is Domus Ventilation's answer to the increasing demand for improved indoor air quality in the construction industry.

This range of in-line carbon filters are designed to be situated on the supply leg of a mechanical ventilation system, negating the need for thermal insulation, and preventing up to 99.5% of airborne contaminants entering the property. Whilst the immediate emphasis is on the filtration of harmful NO₂, often found in high levels within cities across the UK, there is also the option of a PM2.5 pre-filter to maximise the filtration of Particulate Matter equal or larger in size to 2.5 microns.



Removes up to **99.5%** of harmful NO₂

Range of Options

There are two units available in the range with the only difference being what filters are included at purchase. The **NOX-FILT** houses a carbon filter cell only, whereas the **NOX-FILT2.5** includes a PM2.5 pre-filter.

To specify the **NOX-FILT** with or without a PM2.5 pre-filter, choose the relevant code from the table opposite.

Dimensions (mm)

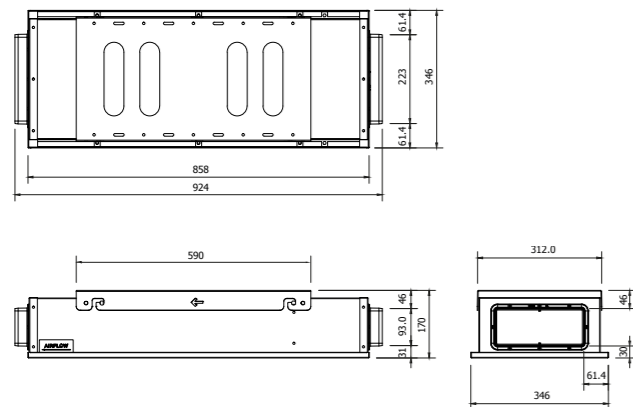

Key features

- ▶ Up to 99.5% NO₂ filtration
- ▶ Simple to replace, single carbon filter cartridge
- ▶ Low resistance meaning ventilation systems are not affected
- ▶ Optional PM2.5 pre-filter offering increased Particulate Matter filtration
- ▶ Low profile for space restrictions
- ▶ Tested in accordance with BS EN ISO 7235:2009



Performance

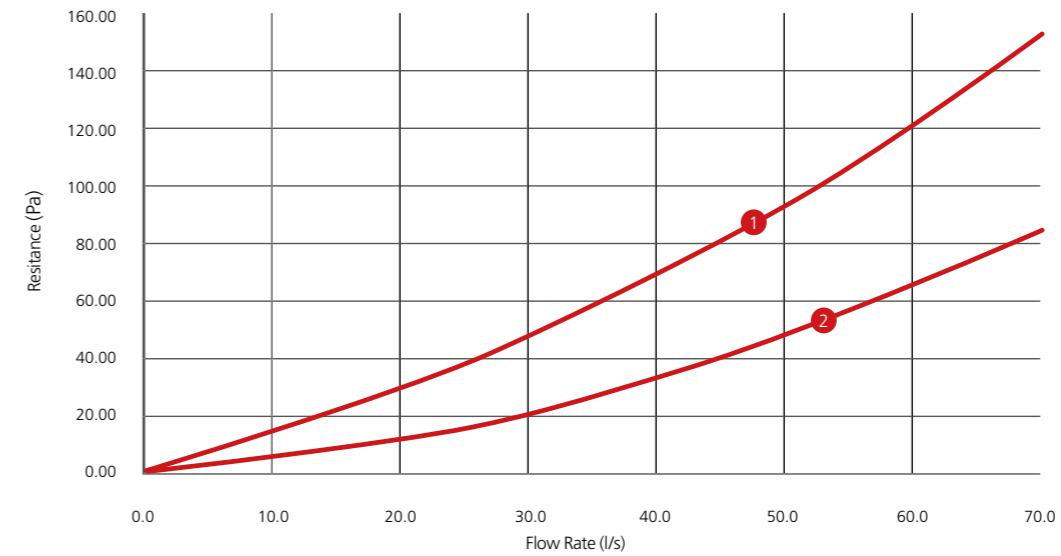

KEY

- 1 NOX-FILT2.5
Carbon filter with PM2.5 pre-filter included
- 2 NOX-FILT
Carbon filter only

Code	Description
NOX-FILT	Inline carbon filter
NOX-FILT2.5	Inline carbon filter with additional PM2.5 pre-filter

Code	Accessories
NOX-PM2.5	Replacement PM2.5 filter
NOX-CF	Replacement carbon filter cell

Consultant Specification for NOX-FILT

The **NOX-FILT** shall be manufactured in sheet metal, with an integral foam lining to reduce noise & provide internal sealing. Each inline filter shall have the ability to have an optional PM10 or PM2.5 pre-filter inserted into the filter box to be capable of additional particulate filtration; particularly from diesel vehicle fumes.

The **NOX-FILT** shall come complete with a removable mounting bracket.

The **NOX-FILT** shall come complete with a plastic construction carbon filter, containing two 30mm (approx.) beds of activated carbon pellets providing a large surface to filter the airflow. The filters shall be easily removed and replaced when required. The filter shall have a minimum efficiency of between 96% and 99.5% effectiveness in the removal of Nitrogen Dioxide.

The unit efficiency shall be confirmed and independently verified by a BRE (Building Research Establishment) test method and the information shall be provided by the filter manufacturer for approval.

The unit shall be suitable for 220x90mm ducting.

The unit shall be installed in conjunction with the manufacturer's installation and maintenance guidelines.

Bulk Destiny	kg/m ³	480 (+/-5%)
Nominal diameter of cylindrical pellets	mm	4.0
Nominal length of cylindrical pellets	mm	8.0
Moisture content (approx.)	%	3
Crush strength (minimum)	kg	2
Removal capacity for Cl2 of own weight	%	10
Minimum design efficiency	%	99.5
Typical air velocity	m/s	0.3 - 2.5
Suitable for relative humidities	%	10 - 95
Temperature range	°C	-20 - +51

The unit shall be offered with a 5 year warranty; 1 year parts and labour, remaining years parts only. This warranty is void if the equipment is modified without authorisation, is incorrectly applied, misused, disassembled or not installed, commissioned and maintained in accordance with the details contained in the I&M manual and general good practice.

► Intermittent Extract Fans

Our range of bathroom and kitchen fans provide rapid local extraction and include axial, in-line and centrifugal options. The Domus range has earned itself a superb reputation for quality, reliability and ease of installation.

How a fan works

Also known as System 1 in Approved Document F of the Building Regulations, intermittent extract is a classic method of ventilating a home, either under occupant or automatic control i.e. a timer or a pull cord.



Our Sapphire range

- ▶ Ultra quiet ventilation
- ▶ Stylish design
- ▶ Complies with Building Regulations and the ErP Directive
- ▶ Optional fascias for axial 100mm fans
- ▶ UK manufactured

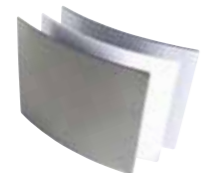

Electrical safety zones

Where is it safe to install a fan?

Fans are commonly 240 Volts, however to protect occupants who need a fan installing close to a shower or bath, there are Separated Extra Low Voltage (SELV), 12 Volt, fans available.

Please use our illustration to help you know where you should and SHOULDN'T install a fan, as well as knowing where you need a 240 or 12 Volt fan.

For more information, see section 701 of British Standard 7671:2008.

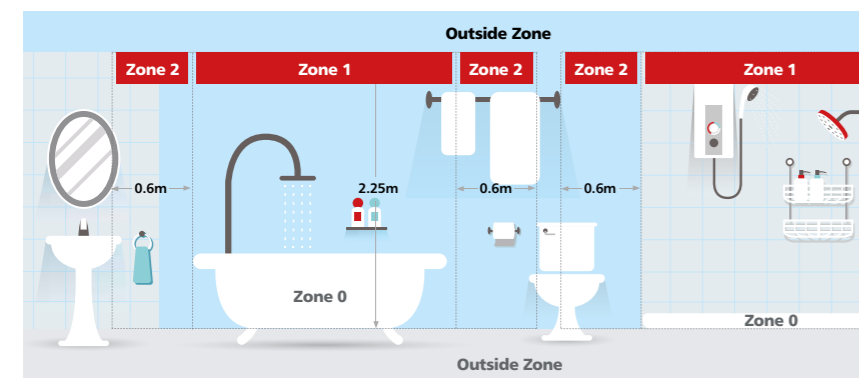

- Zone 0**
No fans permitted.
- Outside Zone**
Fans positioned in this area will be less effective.
- Zone 1**
12 Volt (SELV) fans. Must be positioned above Zone 0 over 2.25m from the floor.
- Zone 2**
230 Volt fans. Must be positioned horizontally 0.6m from Zone 1.

If in doubt, contact a qualified electrician for installation.

How to choose the right fan

1 Step one

What sort of property are you installing into:

A new-build property?  NEW-BUILD & REPLACING FANS

An existing property?  REPLACING FANS

2 Step two

What wet room are you installing into:

 BATHROOM

 TOILET

 KITCHEN

 UTILITY ROOM

3 Step three

What sort of fan and model do you want:

Axial models



Connect to a short duct run, up to 1.5m in length, typically running through a wall to an external grille.

Typical axial installation

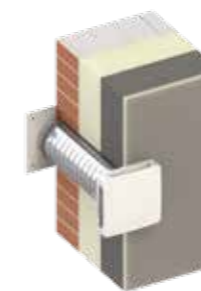

In-Line models



Perfect for shower applications and commonly mounted in a loft or ceiling void with up to 3m of duct.

Typical in-line installation

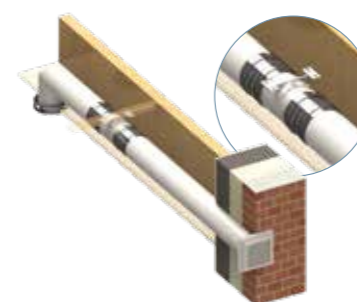

Centrifugal models



Suitable for longer duct runs up to 6m in length and can be wall or ceiling mounted.

Typical centrifugal installation



4 Step four

What voltage your fan should be:

240V or 12V (SELV).

For more information on whether you need a 240V or a 12V (SELV) fan, see page 30 (left).



5 Step five

What extra options do you need:



Timer



Pull Cord



Humidistat



PIR



LED



Retail Pack



Duct Kit



Twin Speed

SYSTEM 1

Intermittent Extract | Axial Fans | Sapphire Range

GTF 100mm (4") Energy Efficient

Key features

- ▶ Extract rates comply with current Building Regulation requirements
- ▶ Offers very low SFP down to 0.22 (W/l/s)
- ▶ Provides effective ventilation
- ▶ Quiet in operation
- ▶ Stylish fascia to fit interior design scheme
- ▶ Suitable for bathroom and toilet
- ▶ Ability to mix and match fascia options



Technical data

Description	230V	SELV (230/12V)
Max Extract Volume (l/s)	23	24
Max Extract Volume (m³/h)	83	86
Max Pressure (Pa)	30	27
Supply Frequency (Hz)	50	50
Specific Fan Power (W/l/s)	0.37	0.22
Max Power (W)	8.5	4/Standby 0.2
Max Sound dB(A) @ 3m	32	32
Weight (kg)	0.7	0.8 inc transformer
IP Rating	X4	X4
Max Operating Temperature (°C)	40	40
Wall-Fit Hole Diameter (mm)	110	110
Warranty	2 yrs	2 yrs

Accessories

1K	Wall Fitting Kit
TFF100-CF1W	Fascia, Curved, Gloss White Finish, 202x202mm
TFF100-CF1S	Fascia, Curved, Silver Finish, 210x202mm
TFF100-CF1BM	Fascia, Curved, Brushed Metal Finish, 210x202mm
TFF100-DT1W	Fascia, Circular Indent, Gloss White Finish, 210x202mm
TFF100-DT1S	Fascia, Circular Indent, Silver Finish, 210x202mm

Dimensions

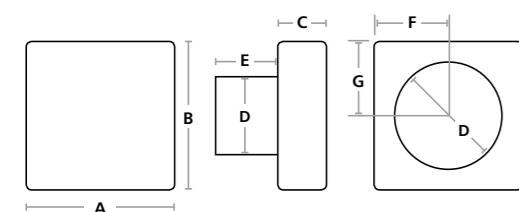

Measured in mm
A: 150 B: 150 C: 37 D: 99 E: 139 F: 75 G: 25

Models

Product Code	SELV	Back Draught	Retail Pack	Pull Cord	Timer	Humidistat
GTF100-S						
GTF100-SBS		•				
GTF100LV-SBS	•	•				
GTF100-SR			•			
GTF100-PCBS		•		•		
GTF100LV-PCBS	•	•		•		
GTF100-PCR			•	•		
GTF100-T					•	
GTF100LV-T	•				•	
GTF100-TBS		•			•	
GTF100LV-TBS	•	•			•	
GTF100-TR			•		•	
GTF100-H					•	•
GTF100LV-H	•				•	•
GTF100LV-HBS	•	•			•	•

Performance

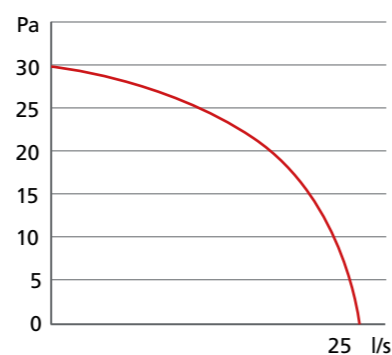

System 1 Intermittent Extract | Axial Fans | Sapphire Range

GTF 150mm (6") Energy Efficient

Key features

- ▶ Comply with current Building Regulation requirements
- ▶ Offers a very low SFP down to 0.48 (W/l/s)
- ▶ Quiet in operation
- ▶ Style fascia to fit interior design scheme
- ▶ Reduces carbon emissions
- ▶ Suitable for kitchen and utility
- ▶ Ideal for new-build and replacement



Technical data

Description	230V
Max Extract Volume (l/s)	60
Max Extract Volume (m³/h)	216
Max Pressure (Pa)	50
Supply Frequency (Hz)	50
Specific Fan Power (W/l/s)	0.48
Max Power (W)	29/Standby 0.2
Max Sound dB(A) @ 3m	49
Weight (kg)	0.8
IP Rating	X4
Max Operating Temperature (°C)	40
Wall-Fit Hole Diameter (mm)	160
Warranty	2 yrs

Dimensions

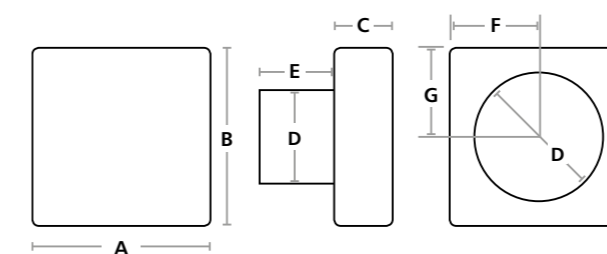

Measured in mm
A: 201 C: 44 E: 61 G: 100.5
B: 201 D: 150 F: 100.5

Models

Product Code	Pull Cord	Timer	Humidistat	PIR
GTF150-S				
GTF150-PC	•			
GTF150-T		•		
GTF150-H		•	•	

Accessories

15K	Wall Fitting Kit
-----	------------------

Performance

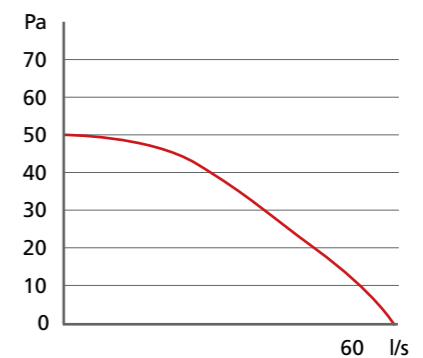

Centrifugal Fans | Sapphire Range

GCF 100mm (4")

Energy Efficient

Key features

- ▶ Comply with current Building Regulation requirements
- ▶ Offers a very low SFP down to 0.39 W/(l/s)
- ▶ Quiet in operation
- ▶ Stylish fascia to fit interior design scheme
- ▶ Reduces carbon emissions



Suitable for **BATHROOM** **TOILET**
Ideal for new build and replacement

Technical data

Description	230V	SELV (230/12V)
Max Extract Volume (l/s)	19	19
Max Extract Volume (m³/h)	69	69
Max Pressure (Pa)	91	91
Supply Frequency (Hz)	50	50
Specific Fan Power (W)/(l/s)	0.39	0.39
Max Power (W)	7.4	7.4
Max Sound Level dB(A) @3m	38	38
Weight (kg)	0.85	0.95
IP Rating	X4	X4
Max Operating Temperature (°C)	40	40
Warranty	2 yrs	2 yrs

Dimensions

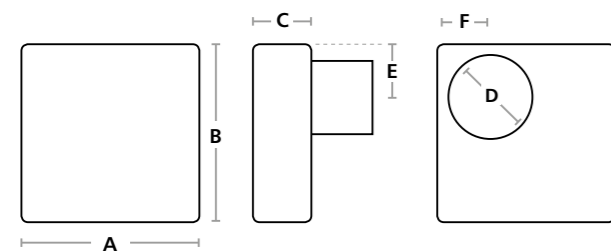

Measured in mm
A: 170 D: 99
B: 170 E: 72
C: 110 F: 69

Models

	SELV	Pull Cord	Timer	Humidistat
GCF100-S				
GCF100-T			•	
GCF100LV-T	•		•	
GCF100LV-HPC	•	•	•	•

Accessories

SAPFD | Fire Damper Back Plate

Performance

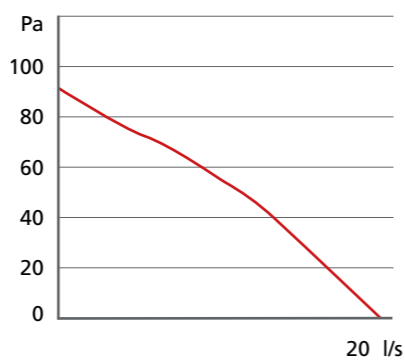

IN-LINE FANS MIXED FLOW

Extract Fans | Vitalis Range

VIT 100mm (4")

High Performance

Key features

- ▶ Very high air flow performance
- ▶ Concealed fan for discreet operation
- ▶ Ideal for longer duct runs
- ▶ Suitable for bathroom, toilet and utility
- ▶ Ideal for replacement



Technical Data

Description	230V
Max Extract Volume (l/s)	High 44.4/Low 39.5
Max Extract Volume (m³/h)	High 187/Low 145
Max Pressure (Pa)	116
Supply Frequency (Hz)	50
Max Power (W) (Fan Only)	High 28/Low 25
Max Sound dB(A) @ 3m	High 34/Low 27
Weight (kg) (Fan Only)	1.4
IP Rating	X4
Max Operating Temperature (°C)	40
Warranty	2 yrs

Dimensions

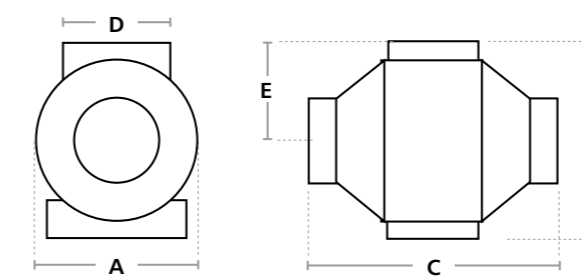

100mm (4")

Measured in mm
A: 160 D: 96
B: 195 E: 102
C: 260

Models

	Duct Kit	Timer	LED Light
VIT100B			
VIT100TB		•	
DVF831ET	•		
DVF832ET	•	•	
SPV831ETLED	•		•
SPV832ETLED	•	•	•

Accessories

SPV801TWCG | Spotvent Ceiling Light Grille

Performance

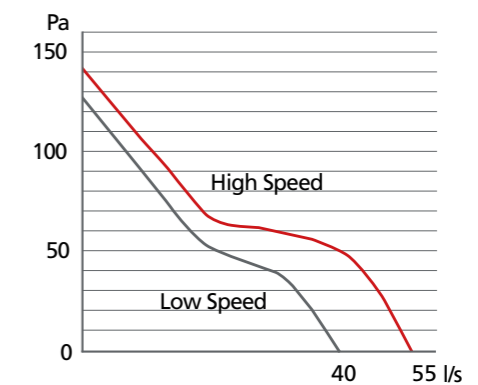

IN-LINE FANS MIXED FLOW

Extract Fans | Vitalis Range

VIT 150mm (6") High Performance

Key features

- ▶ High air flow performance
- ▶ Concealed fan for discreet operation
- ▶ Ideal for longer duct runs
- ▶ Suitable for bathroom, toilet and utility
- ▶ Ideal for replacement



Suitable for
 BATHROOM TOILET KITCHEN
 UTILITY ROOM REPLACING FANS
 Ideal for new build and replacement



Models

VIT100B	Timer
VIT100TB	•

Example Duct Kit



Technical Data

Description	230V
Max Extract Volume (l/s)	High 44.4/Low 39.5
Max Extract Volume (m³/h)	High 187/Low 145
Max Pressure (Pa)	116
Supply Frequency (Hz)	50
Max Power (W) (Fan Only)	High 28/Low 25
Max Sound dB(A) @ 3m	High 34/Low 27
Weight (kg) (Fan Only)	1.4
IP Rating	X4
Max Operating Temperature (°C)	40
Warranty	2 yrs

Dimensions

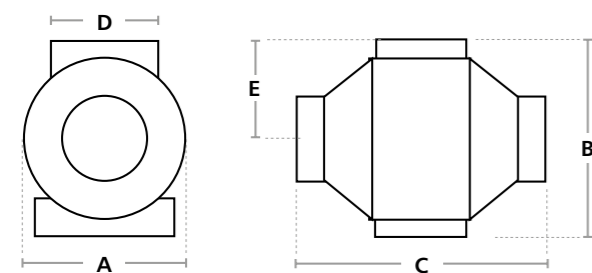

Measured in mm
 A: 220 D: 145
 B: 250 E: 130
 C: 295

Performance

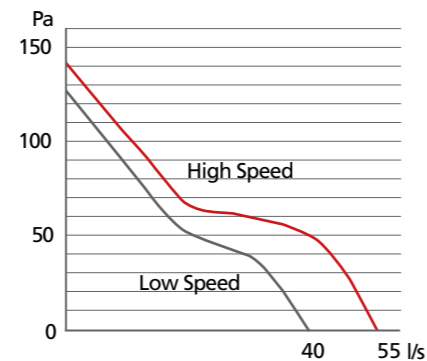

Ducting Range

Our range of Domus ducting offer a high quality solution for domestic and commercial applications.

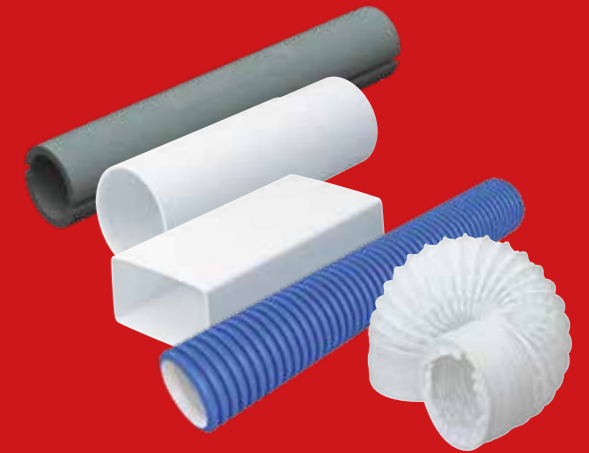

- ▶ **Rigid Ducting** 38
High quality, market leading range of uPVC ducting with a vast selection, available in six different profiles
- ▶ **Domus Adapt** 87
A unique duct solution, allowing for simple connections between PCDB listed Domus Radial semi-rigid duct and standard uPVC
- ▶ **Rigid Duct Flow Control Plenum for Architectural Grilles** 72
Includes an integral flow control device, allowing connection to a range of stylish grilles and single fix commissioning
- ▶ **Thermal Duct Insulation** 92
A unique and patented duct insulation system, designed specifically to radically improve the thermal insulation of rigid ducting in domestic properties
- ▶ **Fire Solutions** 95
Intumescent Fire Sleeves and Ceiling Air Valves, preventing the spread of fire where Domus rigid ducting penetrates fire compartment walls
- ▶ **Flexible and Semi Rigid** 74
A vast range to use in all type of application, available in all ducting size from 110x54mm to 150mm (including Hose, Insulated Hose and Aluminium Hose)
- ▶ **Grilles and Terminals** 98
Available in a variety of colours with aesthetically pleasing designs
- ▶ **Ducting Ancillaries** 81
Ancillary items to complete your installations
- ▶ **Domus Radial** 84
Award-winning radial semi-rigid duct system, which can be up to 60% quicker to install, saving both time & money
- ▶ **Attenuation** 106
Attenuators which significantly reduce transmitted noise from centralised appliances and prevent cross talk travelling between rooms in duct systems



► Rigid Ducting

As a branch based system, rigid duct is ideal for new-build or for where space isn't restricted and can be used with MVHR, MEV, dMEV or intermittent extract.

Key features

- Available in six different profiles to suit any application
- Comes with a full set of adapters to enable a simple or complex system
- High levels of air tightness and system efficiency
- Supported by patented duct insulation, fire stopping & sound attenuation components
- Range includes high efficiency duct bends, designed to reduce duct resistance and overall system energy usage

Profile selector & application

Appliance duct connection size					
100mm (4")		125mm (5")		150mm (6")	
What depth is available for the duct?		What depth is available for the duct?		What depth is available for the duct?	
60-105mm	105mm+	65-130mm	130mm+	97-155mm	155mm+
110x54mm	Ø100mm	204x60mm	Ø125mm	220x90mm	Ø150mm

When a profile has been specified and the duct layout designed, the system resistance must be calculated to ensure that the appliance has sufficient power to more than match the resistance of the complete system.

Product	Size	Range	Free Area	Density	Operating Temp
Rectangular					
	110x54mm	System 100	5,300mm ²	1.51g/cm ³	-15° - 60°
	204x60mm	Supertube	11,200mm ²	1.51g/cm ⁴	-15° - 60°
	220x90mm	Megaduct	17,968mm ²	1.51g/cm ⁵	-15° - 60°
Round					
	Ø100mm	EasiPipe 100	7,850mm ²	1.51g/cm ³	-15° - 60°
	Ø125mm	EasiPipe 125	12,266mm ²	1.51g/cm ⁴	-15° - 60°
	Ø150mm	EasiPipe 150	17,263mm ²	1.51g/cm ⁵	-15° - 60°

i Where components are listed with one of three connection profiles; Male, Female or Duct.



Male:
The fitting will fit inside duct.

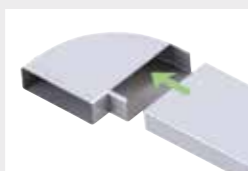

Female:
The fitting will fit around duct.



Duct:
The connection profile is the same as the duct and may need a Female or Male straight connector to couple to duct.

Rigid Ducting | Rectangular

All performance data has been taken from BRE Test Report PR0393-1004:2015.

Duct – 1m

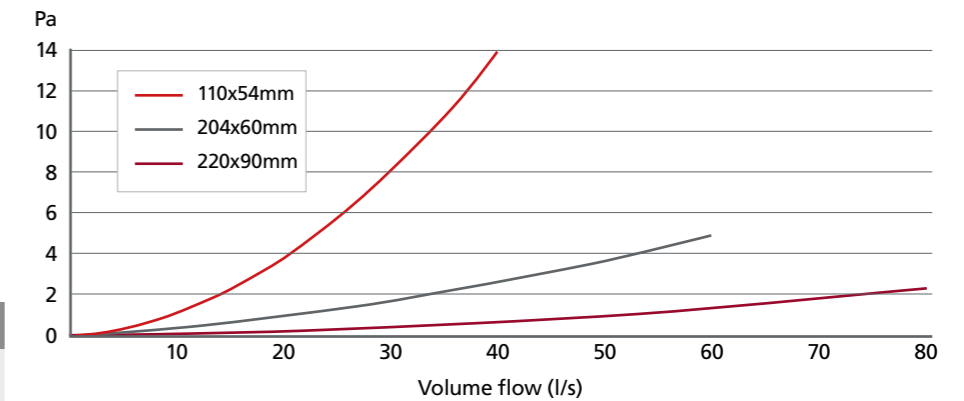

110x54mm System		Free area 5,300mm ²
204x60mm System		Free area 11,200mm ²
220x90mm System		Free area 17,968mm ²

Size	@5l/s	@10l/s	@15l/s	@20l/s	@25l/s	@30l/s	@35l/s	@40l/s
110x54mm	0.3	1	2.1	3.7	5.5	8.3	10.2	13.5
Size	@10l/s	@20l/s	@30l/s	@40l/s	@50l/s	@60l/s	@70l/s	@80l/s
204x60mm	0.3	0.9	1.6	2.6	3.7	4.7	-	-
220x90mm	0	0.3	0.3	0.5	1.1	1.4	1.6	2.3

Code	Duct Size	Description	Connection	Material	Colour	Fire Standards	Manufactured to
DD010	110x54mm	1m straight length of ducting	Duct	Extruded uPVC	White	UL94V0	ISO9001
510	204x60mm	1m straight length of ducting	Duct	Extruded uPVC	White	UL94V0	ISO9001
910	220x90mm	1m straight length of ducting	Duct	Extruded uPVC	White	UL94V0	ISO9001

Duct – 1.5m



110x54mm System		Free area 5,300mm ²
204x60mm System		Free area 11,200mm ²
220x90mm System		Free area 17,968mm ²

Code	Duct Size	Description	Connection	Material	Colour	Fire Standards	Manufactured to
DD015	110x54mm	1.5m straight length of ducting	Duct	Extruded uPVC	White	UL94V0	ISO9001
515	204x60mm	1.5m straight length of ducting	Duct	Extruded uPVC	White	UL94V0	ISO9001
915	220x90mm	1.5m straight length of ducting	Duct	Extruded uPVC	White	UL94V0	ISO9001

Rigid Ducting | Rectangular

Duct – 2m

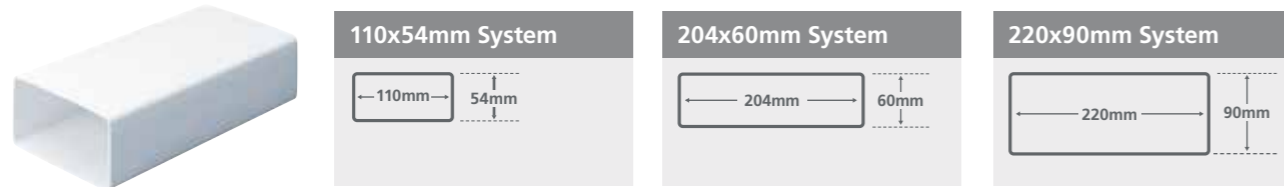

Code	Duct Size	Description	Connection	Material	Colour	Fire Standards	Manufactured to
D1-2000	110x54mm	2m straight length of ducting	Duct	Extruded uPVC	White	UL94V0	ISO9001
D3-2000	204x60mm	2m straight length of ducting	Duct	Extruded uPVC	White	UL94V0	ISO9001
D4-2000	220x90mm	2m straight length of ducting	Duct	Extruded uPVC	White	UL94V0	ISO9001

Straight Duct Connector

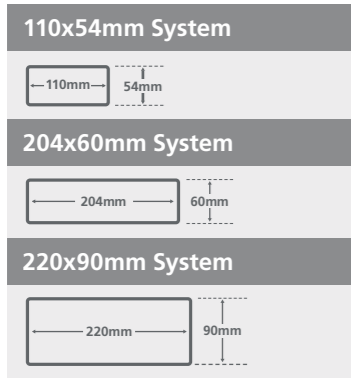
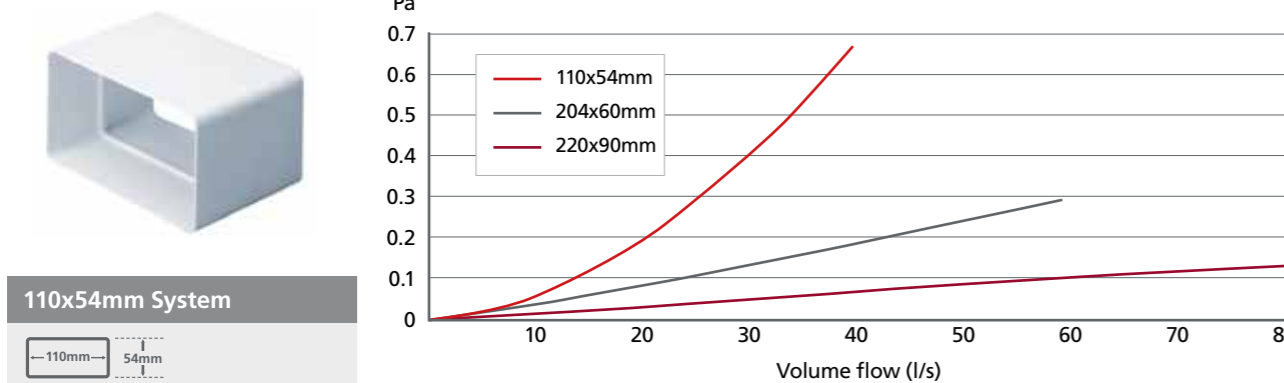

Size	@5l/s	@10l/s	@15l/s	@20l/s	@25l/s	@30l/s	@35l/s	@40l/s	-
110x54mm	0	0	0.2	0.1	0.3	0.2	0.7	0.6	-
Size	@10l/s	@20l/s	@30l/s	@40l/s	@50l/s	@60l/s	@70l/s	@80l/s	@90l/s
204x60mm	0	0	0.2	0.2	0.2	0.3	0.4	0.5	0.3
220x90mm	0	0	0.1	0.1	0	0.1	0.2	0.1	-

Code	Duct Size	Description	Connection	Material	Colour	Fire Standards	Manufactured to
DD020	110x54mm	Straight Duct Connector	Female	HIPS (High Impact Polystyrene)	White	UL94HB	ISO9001
520	204x60mm	Straight Duct Connector	Female	HIPS (High Impact Polystyrene)	White	UL94HB	ISO9001
920	220x90mm	Straight Duct Connector	Female	HIPS (High Impact Polystyrene)	White	UL94HB	ISO9001

Rigid Ducting | Rectangular

Straight Duct Connector with Damper

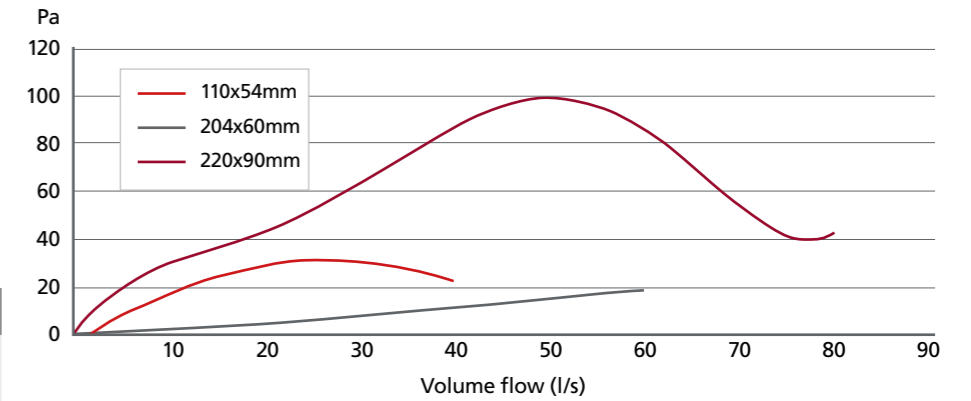

Size	@5l/s	@10l/s	@15l/s	@20l/s	@25l/s	@30l/s	@35l/s	@40l/s	-
110x54mm	9.4	10.6	13.1	21.9	31.4	41	51.7	0.6	-
Size	@10l/s	@20l/s	@30l/s	@40l/s	@50l/s	@60l/s	@70l/s	@80l/s	@90l/s
204x60mm	0.8	2.9	6.5	11.1	17.1	16.8	17.7	17.8	18
220x90mm	23.6	47.3	68.6	77.5	94.9	102.1	43.8	44.6	-

Code	Duct Size	Description	Connection	Material	Colour	Fire Standards	Manufactured to
DD027	110x54mm	Straight Duct Connector with Damper	Female	HIPS (High Impact Polystyrene)	White	UL94HB	ISO9001
527	204x60mm	Straight Duct Connector with Damper	Female	HIPS (High Impact Polystyrene)	White	UL94HB	ISO9001
927	220x90mm	Straight Duct Connector with Damper	Female	HIPS (High Impact Polystyrene)	White	UL94HB	ISO9001

Universal Duct Connector

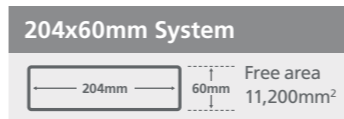
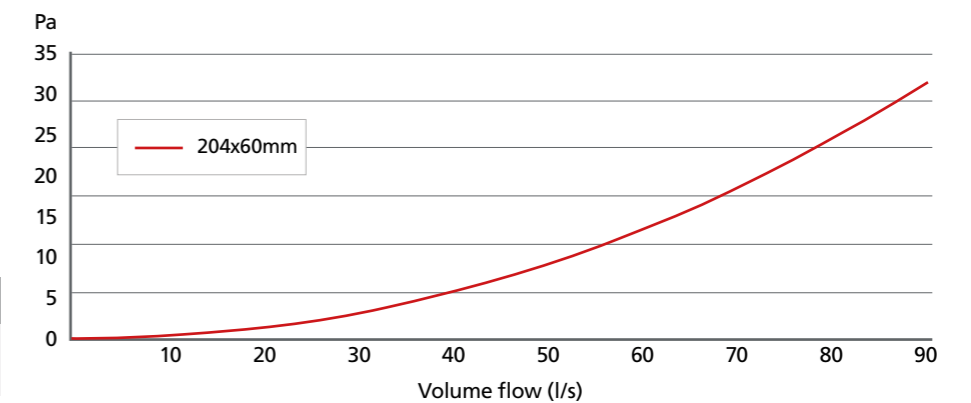

Size	@10l/s	@20l/s	@30l/s	@40l/s	@50l/s	@60l/s	@70l/s	@80l/s	@90l/s
204x60mm	0.3	1.4	3.5	6	8.9	13.5	18.8	24.4	32.3

Code	Duct Size	Description	Connection	Material	Colour	Manufactured to
5B303	204x60mm	Universal Duct Connector	Male	Santroprene	Black	ISO9001

*Includes two Domus Ventilation 520 straight connectors in test data

Rigid Ducting | Rectangular

90° Horizontal Green Line High Efficiency Bend

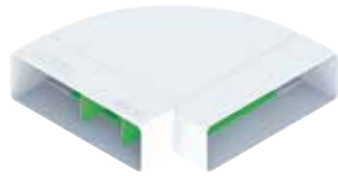

The colour of the internal vanes as shown in the image is illustrative (manufactured in white).

204x60mm System



220x90mm System

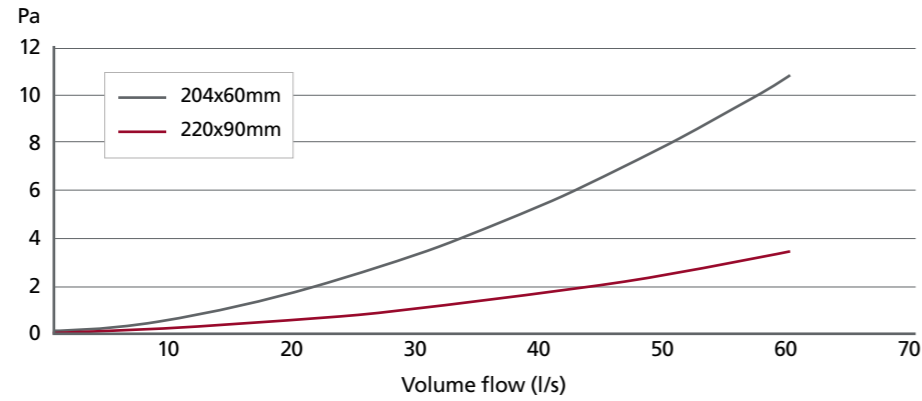

Size	@10l/s	@20l/s	@30l/s	@40l/s	@50l/s	@60l/s	@70l/s	@80l/s
204x60mm	0.4	1.5	3.5	5.4	7.5	10.5	-	-
220x90mm	0.2	0.5	1.0	1.5	2.4	3.3	4.4	5.4

Code	Duct Size	Description	Connection	Material	Colour	Fire Standards	Manufactured to
550-GL	204x60mm	90° Horizontal Bend High Efficiency	Female	Injection Moulded Hips (High Impact Polystyrene)	White	UL94HB	ISO9001
950-GL	220x90mm	90° Horizontal Bend High Efficiency	Female	Injection Moulded Hips (High Impact Polystyrene)	White	UL94HB	ISO9001

Why they are needed:

Due to the profile of a duct bend, air travelling through it can become turbulent, causing increased resistance and system noise. As a consequence, the mechanical ventilation appliance will need to work harder in order to meet the required air flow rates; therefore consuming more energy.

Domus Ventilation Green Line high efficiency 90° duct bends have been specifically designed to enable a uniform flow of air through the section of duct, reducing the duct resistance by up to 60% and lowering the air speed. All of which results in a quieter and more efficient ventilation system.

Performance has been tested by the Building Research Establishment (BRE).

Performance

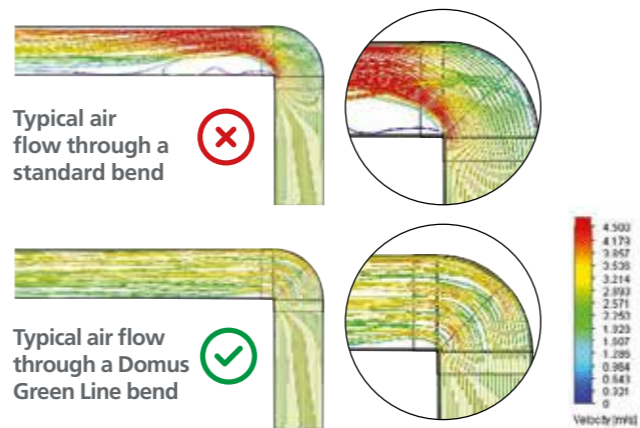

Rigid Ducting | Rectangular

90° Horizontal Bend



110x54mm System



204x60mm System



220x90mm System

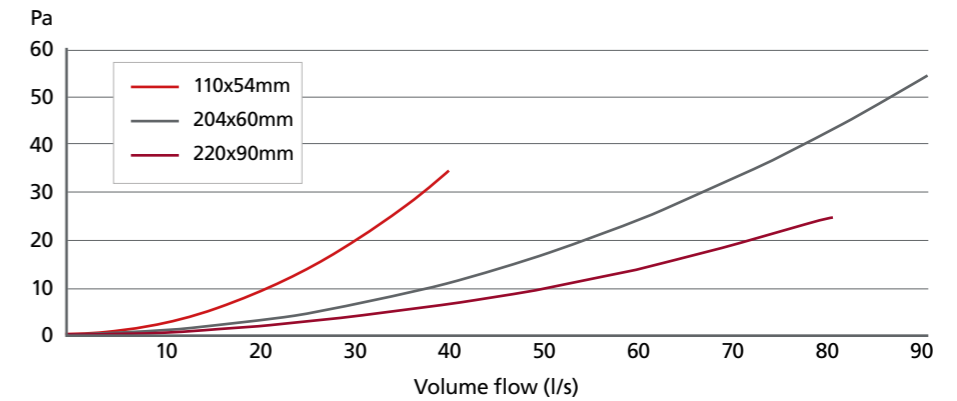

Size	@5l/s	@10l/s	@15l/s	@20l/s	@25l/s	@30l/s	@35l/s	@40l/s	-
110x54mm	0.7	2.3	5.0	8.7	13.4	19.3	26.2	34.3	-

Size	@10l/s	@20l/s	@30l/s	@40l/s	@50l/s	@60l/s	@70l/s	@80l/s	@90l/s
204x60mm	0.8	2.9	6.4	10.9	16.8	23.9	32.7	43.1	54.2
220x90mm	0.3	0.9	2.3	3.5	5.5	7.7	10.7	13.8	-

Code	Duct Size	Description	Connection	Material	Colour	Fire Standards	Manufactured to
DD050	110x54mm	90° Horizontal Bend	Female	HIPS (High Impact Polystyrene)	White	UL94HB	ISO9001
550	204x60mm	90° Horizontal Bend	Female	HIPS (High Impact Polystyrene)	White	UL94HB	ISO9001
950	220x90mm	90° Horizontal Bend	Female	HIPS (High Impact Polystyrene)	White	UL94HB	ISO9001

Rigid Ducting | Rectangular

45° Horizontal Bend

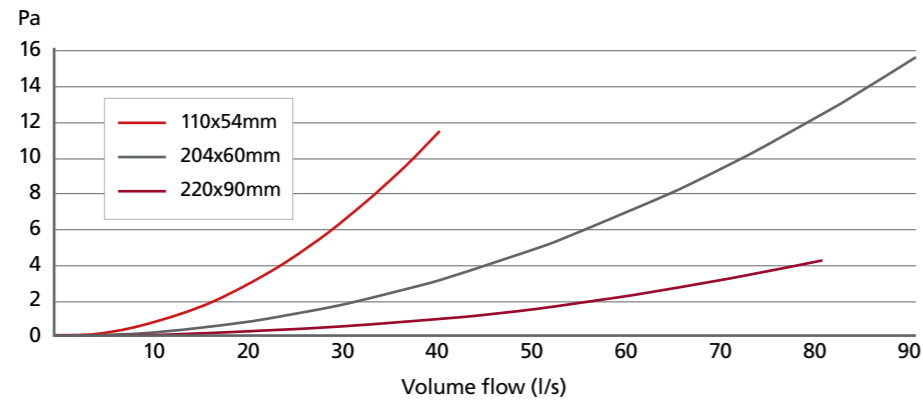

110x54mm System

204x60mm System

220x90mm System

Size	@5l/s	@10l/s	@15l/s	@20l/s	@25l/s	@30l/s	@35l/s	@40l/s	-
110x54mm	0.3	0.8	1.6	3	4.6	6.5	9	11.6	-
Size	@10l/s	@20l/s	@30l/s	@40l/s	@50l/s	@60l/s	@70l/s	@80l/s	@90l/s
204x60mm	0.3	0.8	1.9	3.1	4.9	7.1	9.6	12.6	15.7
220x90mm	0.1	0.3	0.6	1	1.6	2.3	3.3	4.3	-

Code	Duct Size	Description	Connection	Material	Colour	Fire Standards	Manufactured to
DD055	110x54mm	45° Horizontal Bend	Female	HIPS (High Impact Polystyrene)	White	UL94HB	ISO9001
555	204x60mm	45° Horizontal Bend	Female	HIPS (High Impact Polystyrene)	White	UL94HB	ISO9001
955	220x90mm	45° Horizontal Bend	Female	HIPS (High Impact Polystyrene)	White	UL94HB	ISO9001

Horizontal T Piece



110x54mm System

204x60mm System

220x90mm System

Code	Duct Size	Description	Connection	Material	Colour	Fire Standards	Manufactured to
DD080	110x54mm	Horizontal T Piece	Female	HIPS (High Impact Polystyrene)	White	UL94HB	ISO9001
582	204x60mm	Horizontal T Piece	Female	HIPS (High Impact Polystyrene)	White	UL94HB	ISO9001
982	220x90mm	Horizontal T Piece	Female	HIPS (High Impact Polystyrene)	White	UL94HB	ISO9001

For further information please contact our Design Team at vent.projects@domusventilation.co.uk

Rigid Ducting | Rectangular

90° Vertical Bend

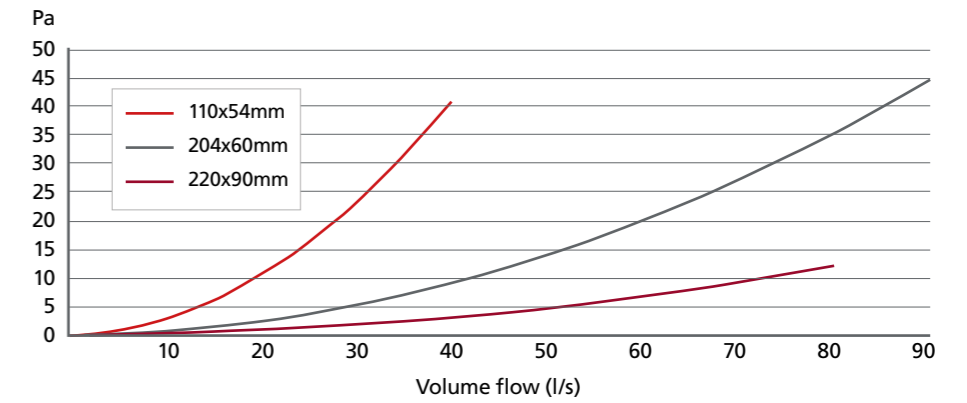

110x54mm System

204x60mm System

220x90mm System

Size	@5l/s	@10l/s	@15l/s	@20l/s	@25l/s	@30l/s	@35l/s	@40l/s	-
110x54mm	0.8	2.5	5.8	10.6	15.6	22.7	31.3	40.2	-
Size	@10l/s	@20l/s	@30l/s	@40l/s	@50l/s	@60l/s	@70l/s	@80l/s	@90l/s
204x60mm	0.7	2.4	5.2	8.9	13.9	19.7	26.7	35.4	44.1
220x90mm	0.3	0.9	1.8	3.1	4.6	6.6	9.2	11.9	-

Code	Duct Size	Description	Connection	Material	Colour	Fire Standards	Manufactured to
DD060	110x54mm	90° Vertical Bend	Female	HIPS (High Impact Polystyrene)	White	UL94HB	ISO9001
560	204x60mm	90° Vertical Bend	Female	HIPS (High Impact Polystyrene)	White	UL94HB	ISO9001
960	220x90mm	90° Vertical Bend	Female	HIPS (High Impact Polystyrene)	White	UL94HB	ISO9001

Rigid Ducting | Rectangular

45° Vertical Bend

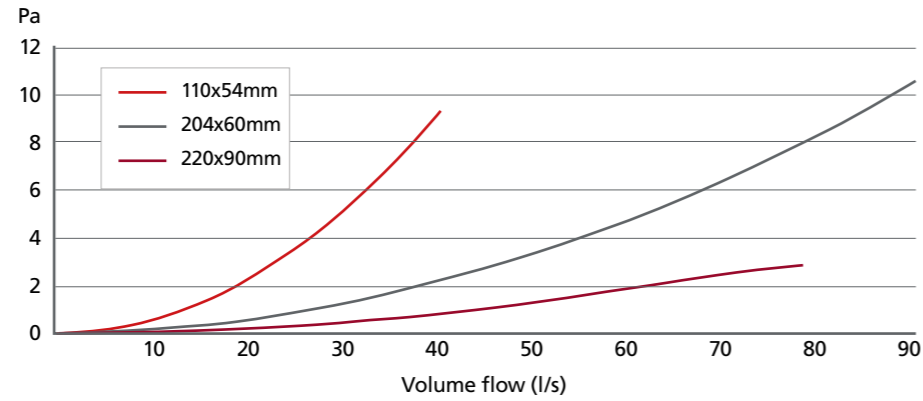

110x54mm System

204x60mm System

220x90mm System

Code	Duct Size	Description	Connection	Material	Colour	Fire Standards	Manufactured to
DD075	110x54mm	45° Vertical Bend	Female	HIPS (High Impact Polystyrene)	White	UL94HB	ISO9001
575	204x60mm	45° Vertical Bend	Female	HIPS (High Impact Polystyrene)	White	UL94HB	ISO9001
975	220x90mm	45° Vertical Bend	Female	HIPS (High Impact Polystyrene)	White	UL94HB	ISO9001

Rigid Ducting | Rectangular

End Caps

Domus Ventilation End Caps provide a quick and easy way of terminating a duct run with an air tight seal.

Product	Code	Description	Connection	Material	Colour	System
	DD018	Rigid Duct End cap	Male	HIPS (High Impact Polystyrene)	White	110x54mm
	518	Rigid Duct End cap	Male	HIPS (High Impact Polystyrene)	White	204x60mm

Wall Plates

For installation between the duct run and external terminal, these wall plates are a simple way to ensure the duct is securely supported and held in place.

110x54mm System

204x60mm System

220x90mm System

Product	Code	Description	Material	Colour	System
	115-4	Rigid Duct Wall Plate	HIPS (High Impact Polystyrene)	White	110x54mm
	115-5W	Rigid Duct Wall Plate	HIPS (High Impact Polystyrene)	White	204x60mm
	115-5B	Rigid Duct Wall Plate	HIPS (High Impact Polystyrene)	Brown	204x60mm
	115-5C	Rigid Duct Wall Plate	HIPS (High Impact Polystyrene)	Cotswold	204x60mm
	115-5T	Rigid Duct Wall Plate	HIPS (High Impact Polystyrene)	Terracotta	204x60mm
	115-6	Rigid Duct Wall Plate	HIPS (High Impact Polystyrene)	White	220x90mm

Duct Clips

Duct clips are effective part of the overall duct system and quick and easy to fasten into place. Domus Ventilation Duct Clips securely hold duct runs and prevent them from bobbing.



Product	Code	Description	Material	Colour	System
	122-4	Rigid Duct Clip	HIPS (High Impact Polystyrene)	White	110x54mm
	522*	Rigid Duct Clip	HIPS (High Impact Polystyrene)	White	204x60mm
	922*	Rigid Duct Clip	HIPS (High Impact Polystyrene)	White	220x90mm

*Two components per fitting required

Rigid Ducting | Round

Domus rigid duct is manufactured from exacting tolerances to virtually eliminate air leakage and reduce pressure drop.

Domus EasiPipe 100 is suitable Bathroom, Toilet and Utility room applications

Ø100mm EasyPipe 100	Ø125mm EasyPipe 125	Ø150mm EasyPipe 150
		
Free Area 7,850mm ²	Free Area 12,266mm ²	Free Area 17,263mm ²

Telescopic Assembly Duct – 0.25-0.45m



Code	Duct Size	Connection	Material	Colour	Fire Standards	Manufactured to
130-4	Ø100mm	Duct	Extruded uPVC	White	UL94V0	ISO9001
130-5	Ø125mm	Duct	Extruded uPVC	White	UL94V0	ISO9001
130-6	Ø150mm	Duct	Extruded uPVC	White	UL94V0	ISO9001

Duct – 0.35m Straight Length of Ducting



Code	Duct Size	Connection	Material	Colour	Fire Standards	Manufactured to
135-4	Ø100mm	Duct	Extruded uPVC	White	UL94V0	ISO9001
135-5	Ø125mm	Duct	Extruded uPVC	White	UL94V0	ISO9001
135-6	Ø150mm	Duct	Extruded uPVC	White	UL94V0	ISO9001

Duct – 1m Straight Length of Ducting



Ø100mm EasyPipe 100

Free Area 7,850mm ²
Ø125mm EasyPipe 125

Free Area 12,266mm ²
Ø150mm EasyPipe 150

Free Area 17,263mm ²

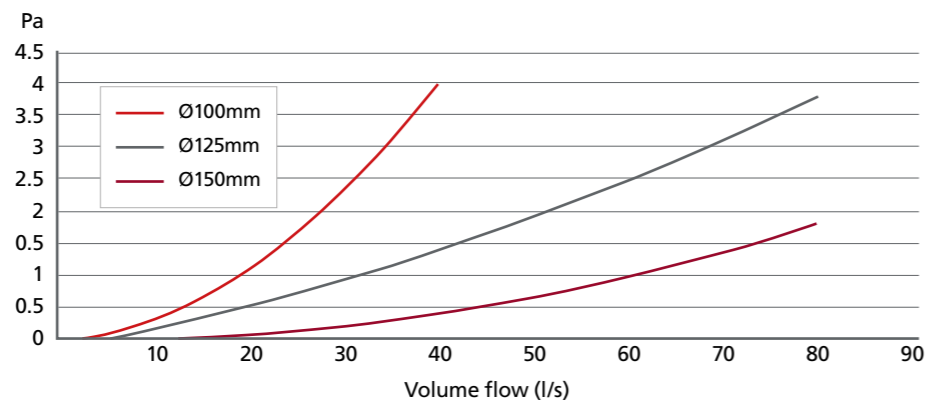

Size	@10l/s	@20l/s	@30l/s	@40l/s	@50l/s	@60l/s	@70l/s	@80l/s
Ø125mm	0.1	0.5	0.8	1.4	2	2.7	3.2	3.7
Ø150mm	0	0.2	0.3	0.3	0.7	1	1.3	1.9

Code	Duct Size	Description	Connection	Material	Colour	Fire Standards	Manufactured to
1100-4	Ø100mm	1m straight length of ducting	Duct	Extruded uPVC	White	UL94V0	ISO9001
1100-5	Ø125mm	1m straight length of ducting	Duct	Extruded uPVC	White	UL94V0	ISO9001
1100-6	Ø150mm	1m straight length of ducting	Duct	Extruded uPVC	White	UL94V0	ISO9001

Rigid Ducting | Round

Duct Sleeve – 1m



Code	Duct Size	Connection	Material	Colour	Fire Standards	Manufactured to
2100-4	Ø100mm	N/A	Extruded uPVC	White	UL94V0	ISO9001
2100-5	Ø125mm	N/A	Extruded uPVC	White	UL94V0	ISO9001
2100-6	Ø150mm	N/A	Extruded uPVC	White	UL94V0	ISO9001



Duct – 2m Straight Length of Ducting



Code	Duct Size	Connection	Material	Colour	Fire Standards	Manufactured to
1200-4	Ø100mm	Duct	Extruded uPVC	White	UL94V0	ISO9001
1200-5	Ø125mm	Duct	Extruded uPVC	White	UL94V0	ISO9001
1200-6	Ø150mm	Duct	Extruded uPVC	White	UL94V0	ISO9001

Straight Duct Connector

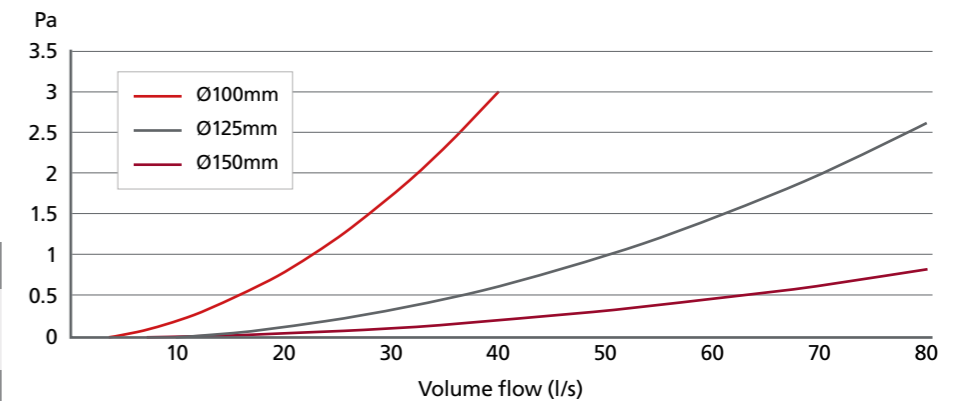

Ø100mm EasyPipe 100

Free Area 7,850mm ²
Ø125mm EasyPipe 125

Free Area 12,266mm ²
Ø150mm EasyPipe 150

Free Area 17,263mm ²



Size	@5l/s	@10l/s	@15l/s	@20l/s	@25l/s	@30l/s	@35l/s	@40l/s
Ø100mm	0	0.2	0.4	0.8	1.3	1.8	2.3	3
Size	@10l/s	@20l/s	@30l/s	@40l/s	@50l/s	@60l/s	@70l/s	@80l/s
Ø125mm	0	0.1	0.3	0.6	1	1.5	2.1	2.5
Ø150mm	0	0.1	0.1	0.2	0.3	0.5	0.7	0.8

Code	Duct Size	Description	Connection	Material	Colour	Fire Standards	Manufactured to
493	Ø100mm	Straight duct connector	Male	HIPS (High Impact Polystyrene)	White	UL94HB	ISO9001
593	Ø125mm	Straight duct connector	Male	HIPS (High Impact Polystyrene)	White	UL94HB	ISO9001
693	Ø150mm	Straight duct connector	Male	HIPS (High Impact Polystyrene)	White	UL94HB	ISO9001

Rigid Ducting | Round

Straight Connector with Damper



Ø100mm EasyPipe 100	 Free Area 7,850mm ²
Ø125mm EasyPipe 125	 Free Area 12,266mm ²
Ø150mm EasyPipe 150	 Free Area 17,263mm ²

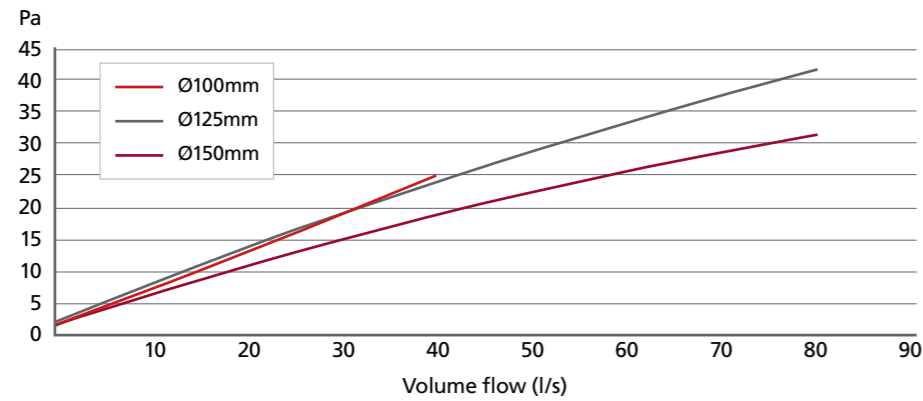



Size	@5l/s	@10l/s	@15l/s	@20l/s	@25l/s	@30l/s	@35l/s	@40l/s
Ø100mm	5.5	7.7	9.9	12.1	14.8	18	20.8	24.9
Ø125mm	10.1	14.5	18.3	23.5	27.5	32.5	38.6	41.3
Ø150mm	7.7	11.5	14.8	18.4	21.4	25	28.9	31.5

Code	Duct Size	Description	Connection	Material	Colour	Fire Standards	Manufactured to
494	Ø100mm	Straight Connector with Damper	Male	HIPS (High Impact Polystyrene)	White	UL94HB	ISO9001
594	Ø125mm	Straight Connector with Damper	Male	HIPS (High Impact Polystyrene)	White	UL94HB	ISO9001
694	Ø150mm	Straight Connector with Damper	Male	HIPS (High Impact Polystyrene)	White	UL94HB	ISO9001

Rigid Ducting | Round

Straight Connector with Damper and Wall Plate



Ø100mm EasyPipe 100	 Free Area 7,850mm ²
Ø125mm EasyPipe 125	 Free Area 12,266mm ²
Ø150mm EasyPipe 150	 Free Area 17,263mm ²

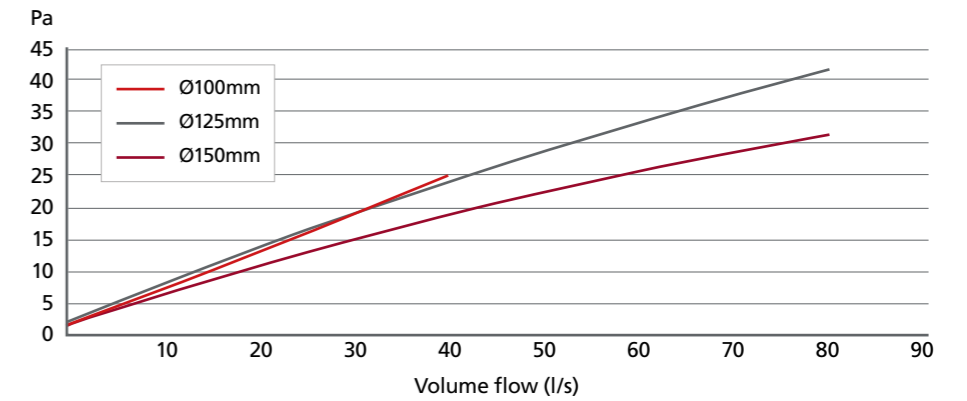

Size	@10l/s	@20l/s	@30l/s	@40l/s	@50l/s	@60l/s	@70l/s	@80l/s
Ø100mm	5.5	7.7	9.9	12.1	14.8	18	20.8	24.9
Ø125mm	10.1	14.5	18.3	23.5	27.5	32.5	38.6	41.3
Ø150mm	7.7	11.5	14.8	18.4	21.4	25	28.9	31.5

Code	Duct Size	Description	Connection	Material	Colour	Fire Standards	Manufactured to
495	Ø100mm	Straight Connector with Damper and Wall Plate	Male	HIPS (High Impact Polystyrene)	White	UL94HB	ISO9001
595	Ø125mm	Straight Connector with Damper and Wall Plate	Male	HIPS (High Impact Polystyrene)	White	UL94HB	ISO9001
695	Ø150mm	Straight Connector with Damper and Wall Plate	Male	HIPS (High Impact Polystyrene)	White	UL94HB	ISO9001

Rigid Ducting | Round

90° Horizontal Bend



Ø100mm EasyPipe 100		Free Area 7,850mm ²
Ø125mm EasyPipe 125		Free Area 12,266mm ²
Ø150mm EasyPipe 150		Free Area 17,263mm ²

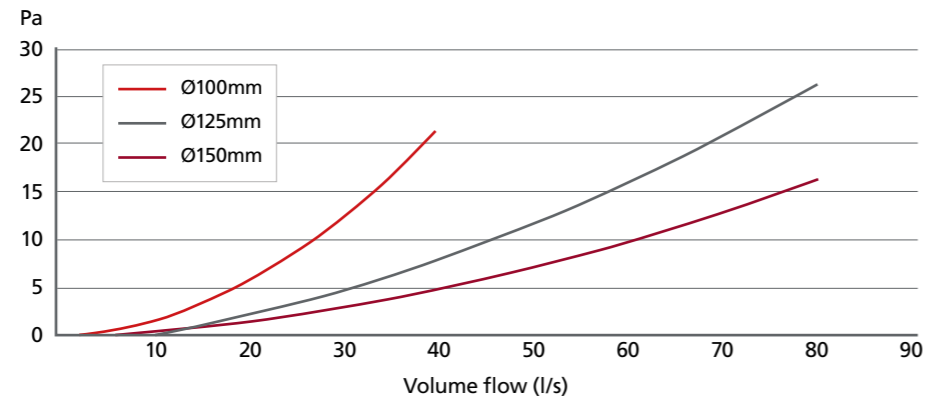

Resistance data in Pascals (Pa)								
Size	@5l/s	@10l/s	@15l/s	@20l/s	@25l/s	@30l/s	@35l/s	@40l/s
Ø100mm	0.4	1.3	3	5.3	8.6	12.2	16	20.8
Size	@10l/s	@20l/s	@30l/s	@40l/s	@50l/s	@60l/s	@70l/s	@80l/s
Ø125mm	0.5	1.8	3.9	7.6	11.3	16.2	21	25
Ø150mm	0.3	1.2	2.5	4.6	7.2	9.9	13.2	15.4

Code	Duct Size	Description	Connection	Material	Colour	Fire Standards	Manufactured to
490	Ø100mm	Rigid Duct 90° Horizontal Bend	Male	HIPS (High Impact Polystyrene)	White	UL94HB	ISO9001
590	Ø125mm	Rigid Duct 90° Horizontal Bend	Male	HIPS (High Impact Polystyrene)	White	UL94HB	ISO9001
690	Ø150mm	Rigid Duct 90° Horizontal Bend	Male	HIPS (High Impact Polystyrene)	White	UL94HB	ISO9001

Rigid Ducting | Round

45° Horizontal Bend



Ø100mm EasyPipe 100		Free Area 7,850mm ²
Ø125mm EasyPipe 125		Free Area 12,266mm ²
Ø150mm EasyPipe 150		Free Area 17,263mm ²

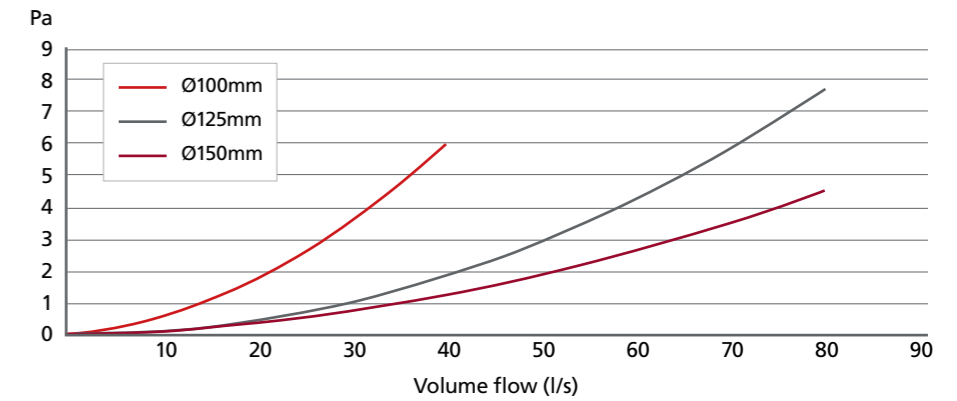

Resistance data in Pascals (Pa)								
Size	@5l/s	@10l/s	@15l/s	@20l/s	@25l/s	@30l/s	@35l/s	@40l/s
Ø100mm	0.2	0.5	1.1	1.7	2.4	3.7	4.7	5.9
Size	@10l/s	@20l/s	@30l/s	@40l/s	@50l/s	@60l/s	@70l/s	@80l/s
Ø125mm	0.1	0.4	1	1.9	2.9	4.2	5.8	7.8
Ø150mm	0.1	0.3	0.7	1.1	1.9	2.8	3.6	4.4

Code	Duct Size	Description	Connection	Material	Colour	Fire Standards	Manufactured to
491	Ø100mm	Rigid Duct 45° Horizontal Bend	Male	HIPS (High Impact Polystyrene)	White	UL94HB	ISO9001
591	Ø125mm	Rigid Duct 45° Horizontal Bend	Male	HIPS (High Impact Polystyrene)	White	UL94HB	ISO9001
691	Ø150mm	Rigid Duct 45° Horizontal Bend	Male	HIPS (High Impact Polystyrene)	White	UL94HB	ISO9001

Rigid Ducting | Round

Horizontal T Piece

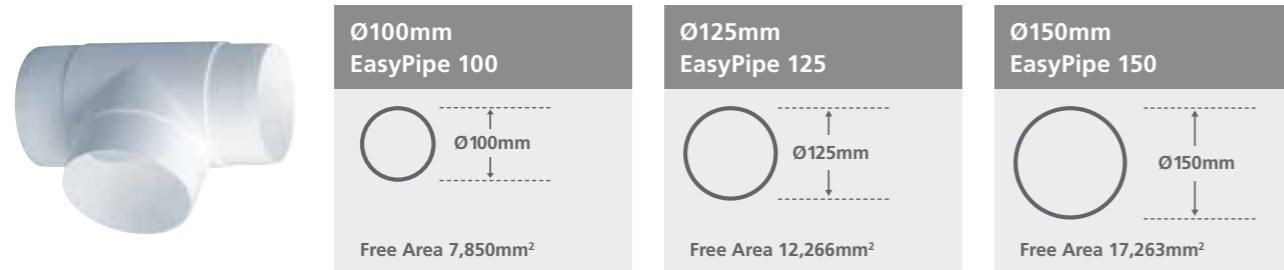

Code	Duct Size	Description	Connection	Material	Colour	Fire Standards	Manufactured to
492	Ø100mm	Rigid Duct Horizontal T Piece	Male	HIPS (High Impact Polystyrene)	White	UL94HB	ISO9001
592	Ø125mm	Rigid Duct Horizontal T Piece	Male	HIPS (High Impact Polystyrene)	White	UL94HB	ISO9001
692	Ø150mm	Rigid Duct Horizontal T Piece	Male	HIPS (High Impact Polystyrene)	White	UL94HB	ISO9001

For further information please contact our Design Team at vent.projects@domusventilation.co.uk

Y Piece – PVC

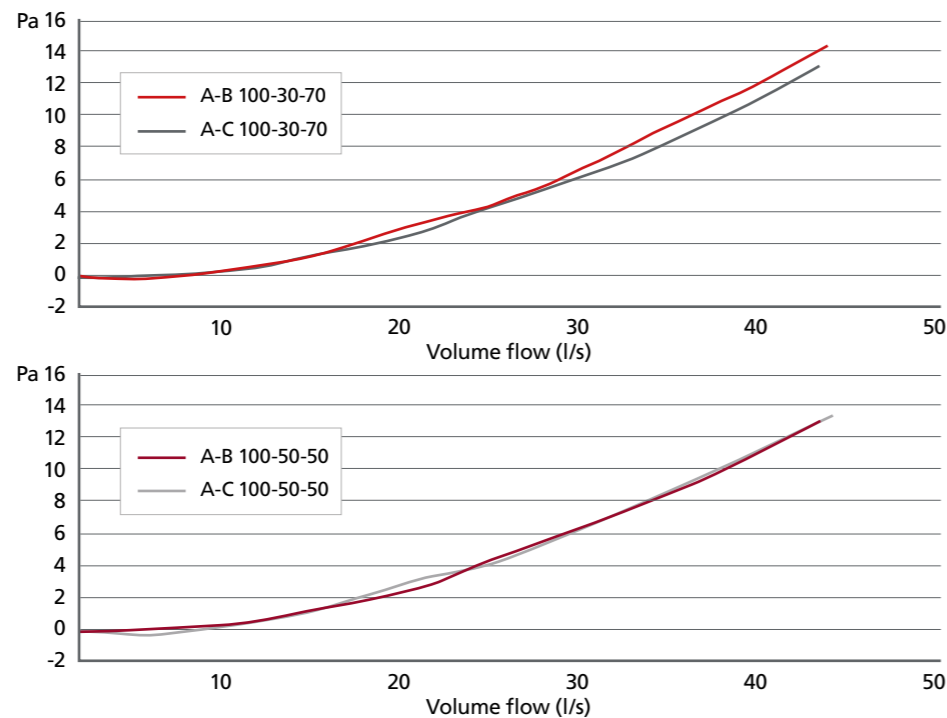

Resistance data in Pascals (Pa)										
	@0l/s	@5l/s	@10l/s	@15l/s	@20l/s	@25l/s	@30l/s	@35l/s	@40l/s	@45l/s
A-B 100-30-70	-0.1	-0.2	0.4	1.4	3.1	4.5	6.7	9.4	11.9	14.8
A-C 100-30-70	-0.1	-0.3	0.4	1.5	3.1	4.4	6.5	8.8	11.3	13.8
A-B 100-50-50	-0.1	0.0	0.4	1.4	2.5	4.5	6.4	8.2	10.7	13.4
A-C 100-50-50	-0.1	0.0	0.4	1.4	2.5	4.5	6.4	8.4	10.7	13.4

Code	Duct Size	Description	Connection	Material	Colour	Fire Standards	Manufactured to
499	Ø100mm	Rigid Duct Y Piece	Male	HIPS (High Impact Polystyrene)	White	UL94HB	ISO9001

Rigid Ducting | Round

Wall Plates

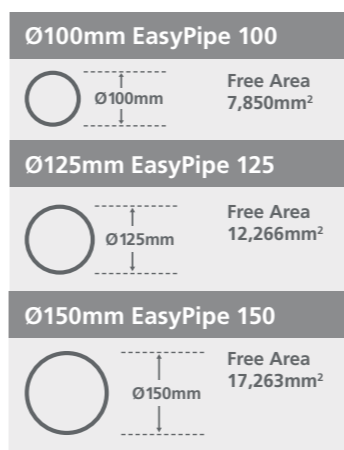

For installation between the duct run and external terminal, these wall plates are a simple way to ensure the duct is securely supported and held in place.

Product	Code	Description	Material	Colour	System
	114-4	Rigid Duct Wall Plate	HIPS (High Impact Polystyrene)	White	Ø100mm
	114-5	Rigid Duct Wall Plate	HIPS (High Impact Polystyrene)	White	Ø125mm
	114-6	Rigid Duct Wall Plate	HIPS (High Impact Polystyrene)	White	Ø150mm

Duct Clips

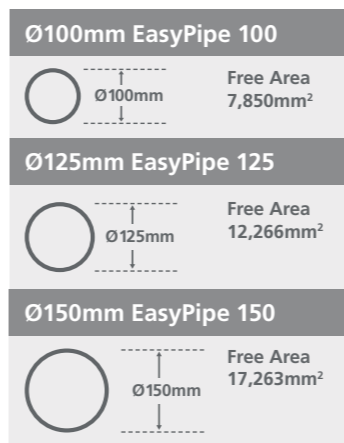

100/125 and 150mm duct size clips are effective part of the overall duct system and quick and easy to fasten into place, Domus Duct Clips securely hold duct runs and prevent them from bobbing.

Product	Code	Description	Material	Colour	System
	496	Rigid Duct Clip – Round	HIPS (High Impact Polystyrene)	White	Ø100mm
	596	Rigid Duct Clip – Round	HIPS (High Impact Polystyrene)	White	Ø125mm
	696	Rigid Duct Clip – Round	HIPS (High Impact Polystyrene)	White	Ø150mm

Rigid Ducting | Round

Condensation Traps with Overflow Connection



497

Ø100mm EasyPipe 100

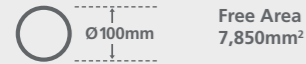

Condensation Trap Pipe Combinations

Code: 100mm/ 110mm

Remove the reducing ring

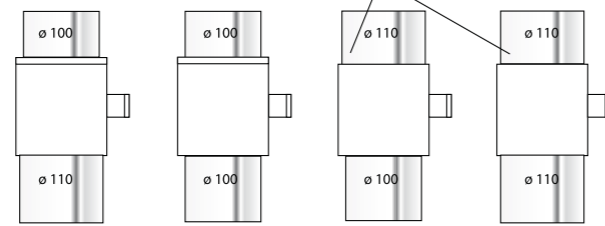

All dimensions shown in mm.

Key features

- ▶ Recommended in both the Building Regulations and NHBC Standards
- ▶ Removes condensation risks from unheated areas
- ▶ Real advantages over using insulated hose
- ▶ Simple to install and handle
- ▶ Cost effective solution
- ▶ Specifically designed for ventilation applications

Code	Duct Size	Description	Connection	Material	Colour	Fire Standards	Manufactured to
497	Ø100mm Ø110mm	Condensation Trap with Overflow Connection	Male/ Female	HIPS (High Impact Polystyrene)	White	UL94HB	ISO9001

Rigid Ducting | In-line Adapter

In-line Adapter, Rectangular to Round (110x54 – Ø100mm)



110x54 – Ø100mm

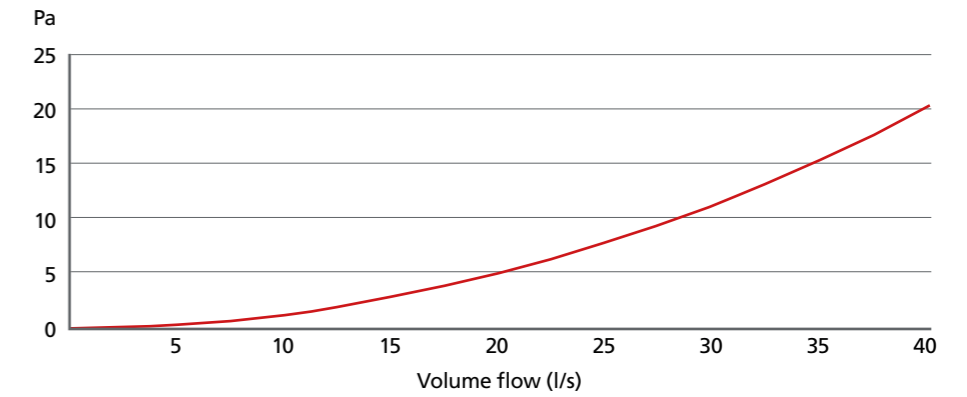

Resistance data in Pascals (Pa)

@5l/s	@10l/s	@15l/s	@20l/s	@25l/s	@30l/s	@35l/s	@40l/s
0.3	1.3	3.0	5.2	8.0	11.4	15.9	20.6

Code	Size From	To (mm)	Description	Connection	Material	Colour	Fire Standards	Manufactured to
DD070	110x54	Ø100	In-line Adapter Rectangular – Round	Female/Duct	PVC	White	UL94HB	ISO9001

In-line Adapter, Rectangular to Round (204x60 – Ø100mm)



204x60 – Ø100mm

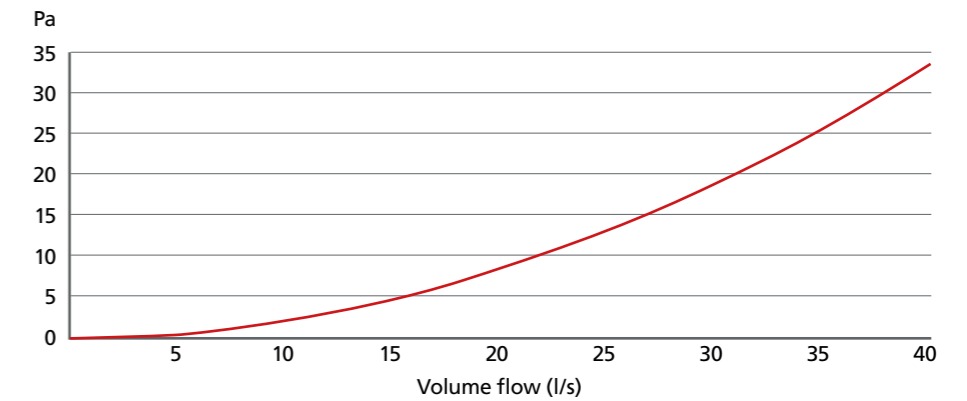

Resistance data in Pascals (Pa)

@5l/s	@10l/s	@15l/s	@20l/s	@25l/s	@30l/s	@35l/s	@40l/s
0.5	2.2	4.8	8.6	13.4	18.9	25.8	33.9

Code	Size From	To (mm)	Description	Connection	Material	Colour	Fire Standards	Manufactured to
DD073	204x60 (to single airbrick)	Ø100	In-line Adapter Rectangular – Round	Duct/Male	PVC	White	UL94HB	ISO9001

Rigid Ducting | In-line Adapter

In-line Adapter, Rectangular to Round (204x60 – Ø125mm)



204x60 – Ø125mm

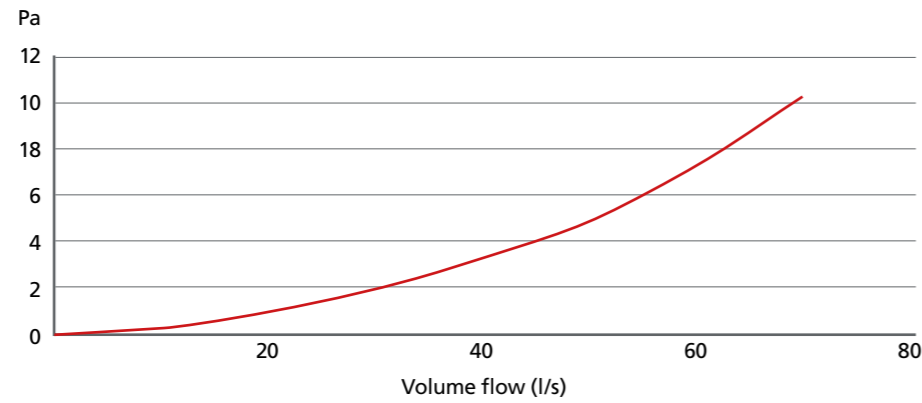

Resistance data in Pascals (Pa)							
@10l/s	@20l/s	@30l/s	@40l/s	@50l/s	@60l/s	@70l/s	@80l/s
0.3	1.0	2.0	3.3	5.0	7.3	10.4	

Code	Size From	To (mm)	Description	Connection	Material	Colour	Fire Standards	Manufactured to
570	204x60	Ø125	In-line Adapter Rectangular – Round	Female/Duct	PVC	White	UL94HB	ISO9001

In-line Adapter, Rectangular to Round (220x90 – Ø150mm)



220x90 – Ø150mm

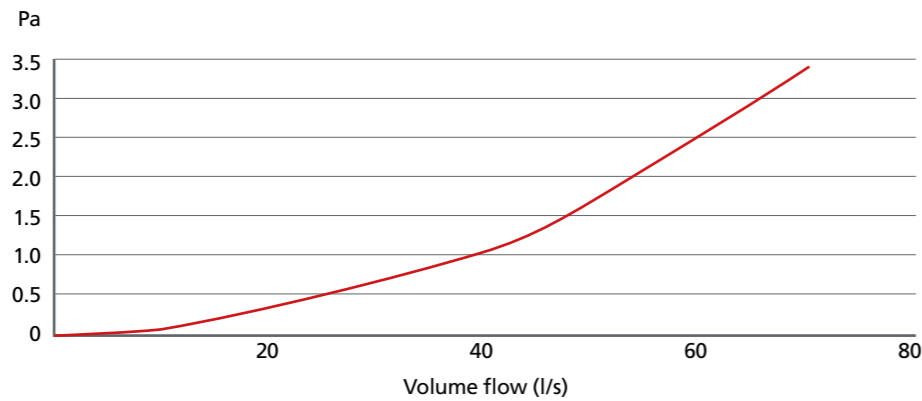

Resistance data in Pascals (Pa)							
@10l/s	@20l/s	@30l/s	@40l/s	@50l/s	@60l/s	@70l/s	@80l/s
0.1	0.3	0.7	1.0	1.6	2.5	3.4	

Code	Size From	To (mm)	Description	Connection	Material	Colour	Fire Standards	Manufactured to
970	220xØ150	Ø150	In-line Adapter Rectangular – Round	Female/Female	PVC	White	UL94HB	ISO9001

Rigid Ducting | In-line Adapter

In-line Adapter, Rectangular to Round (227x133 – Ø100, Ø125, Ø150mm)



227x133mm – Ø100, Ø125, Ø150mm

Performance data for double airbrick (code 954) with adapter (954)

Resistance data in Pascals (Pa)								
Size	@10l/s	@20l/s	@30l/s	@40l/s	@50l/s	@60l/s	@70l/s	@80l/s
Ø125 Supply	0.8	2.9	6.6	11.5	18.0	26.1	35.9	47.2
Ø125 Extract	0.0	0.2	0.4	0.7	1.1	1.7	2.3	4.0
Ø150 Supply	0.5	1.9	4.3	7.6	11.7	17.0	23.1	29.0
Ø150 Extract	0.2	0.6	1.3	2.4	3.7	5.1	6.9	8.6

Performance data for Supply (air from outside)

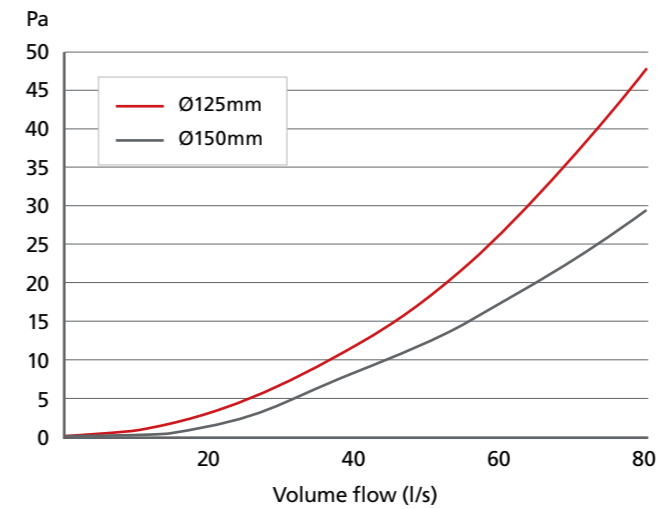

Performance data for Extract (air to outside)

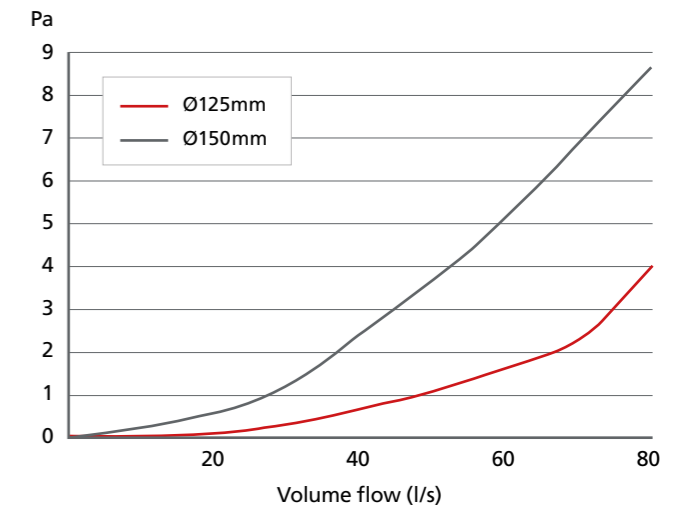

Code	Size From	To (mm)	Description	Connection	Material	Colour	Fire Standards	Manufactured to
954	227x133 (to double airbrick)	Ø100, Ø125, Ø150	In-line Adapter Rectangular – Round	Female/Male/ Male/Male	PVC	White	UL94HB	ISO9001

Rigid Ducting | In-line Adapter

In-line Adapter, Rectangular to Rectangular (204x60 – 110x54mm)



204x60 – 110x54mm

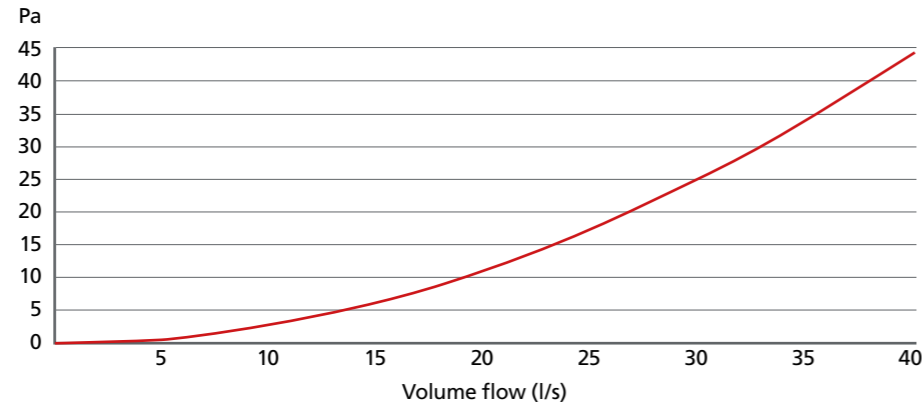

Resistance data in Pascals (Pa)

@5l/s	@10l/s	@15l/s	@20l/s	@25l/s	@30l/s	@35l/s	@40l/s
0.7	2.9	6.3	11.2	17.4	25.3	34.0	44.2

Code	Size From	To (mm)	Description	Connection	Material	Colour	Fire Standards	Manufactured to
DD077	204x60	110x54	In-line Adapter Rectangular – Rectangular	Duct/Male	PVC	White	UL94HB	ISO9001

In-line Adapter, Rectangular to Rectangular (220x90 – 204x60mm)



220x90 – 204x60mm

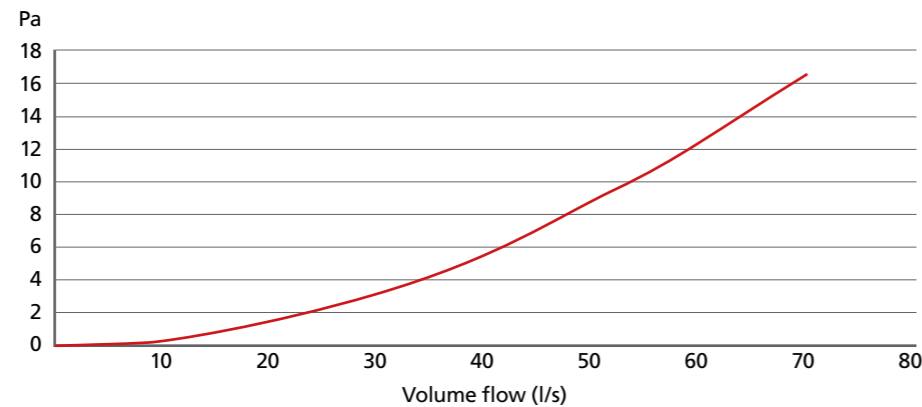

Resistance data in Pascals (Pa)

@10l/s	@20l/s	@30l/s	@40l/s	@50l/s	@60l/s	@70l/s
0.4	1.4	3.3	5.6	8.8	12.6	16.5

Code	Size From	To (mm)	Description	Connection	Material	Colour	Fire Standards	Manufactured to
957	220x90	204x60	In-line Adapter Rectangular – Rectangular	Duct/Female	PVC	White	UL94HB	ISO9001

Rigid Ducting | In-line Adapter

In-line Adapter, Rectangular to Rectangular (220x90 – 204x60mm)



220x90 – 204x60mm

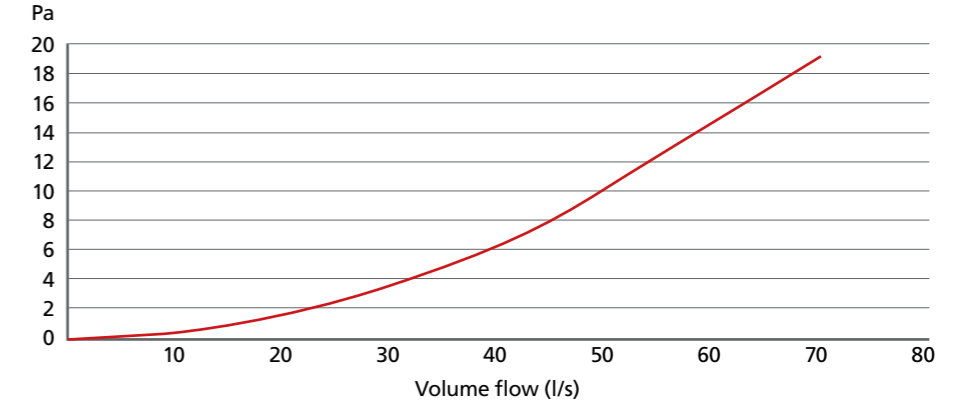

Resistance data in Pascals (Pa)

@10l/s	@20l/s	@30l/s	@40l/s	@50l/s	@60l/s	@70l/s
0.5	1.7	3.7	6.4	10.2	14.7	18.8

Code	Size From	To (mm)	Description	Connection	Material	Colour	Fire Standards	Manufactured to
958	220x90	204x60	In-line Adapter Rectangular – Rectangular	Female/Female	PVC	White	UL94HB	ISO9001

In-line Adapter, Rectangular to Rectangular (227x133 – 220x90mm)



227x133 – 220x90mm

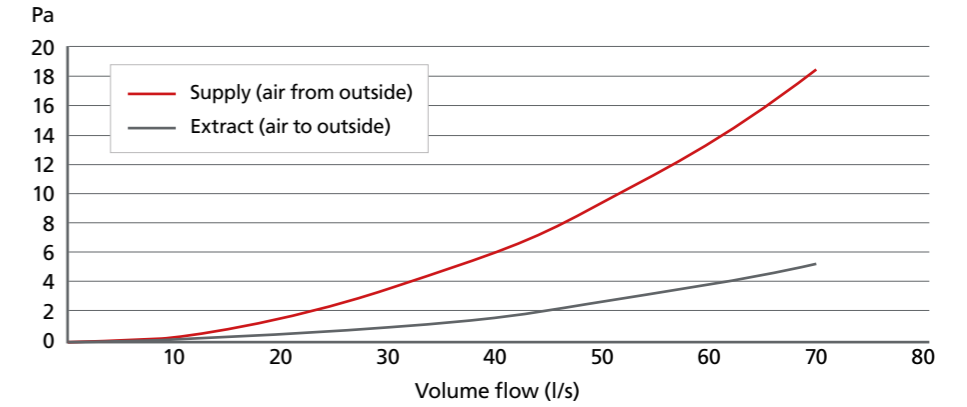

Performance data for double airbrick (code 905) with adapter (977)

Resistance data in Pascals (Pa)

	@10l/s	@20l/s	@30l/s	@40l/s	@50l/s	@60l/s	@70l/s
Supply	0.4	1.5	3.5	6.0	9.3	13.3	18.2
Extract	0.1	0.5	1.0	1.7	2.7	3.9	5.2

Code	Size From	To (mm)	Description	Connection	Material	Colour	Fire Standards	Manufactured to
977	227x133 (to double airbrick)	220x90	In-line Adapter Rectangular – Rectangular	Male/Female	PVC	White	UL94HB	ISO9001

Rigid Ducting | Plenums

Fixed Socket Plenum, Rectangular to Round (110x54 – Ø100mm)



110x54 – Ø100mm

Resistance data in Pascals (Pa)								
Size	@5l/s	@10l/s	@15l/s	@20l/s	@25l/s	@30l/s	@35l/s	@40l/s
Supply – 300mm length pipe	0.4	1.2	3.0	5.2	8.0	11.6	15.6	20.5
Extract – 300mm length pipe	1.4	5.3	11.6	20.4	31.9	45.3	62.0	79.9
Supply – 2000mm length pipe	0.3	0.9	2.2	3.9	6.3	9.1	12.0	15.7
Extract – 2000mm length pipe	1.0	3.0	7.0	12.5	20.1	28.5	38.9	51.3

Performance data for Supply (air from outside)

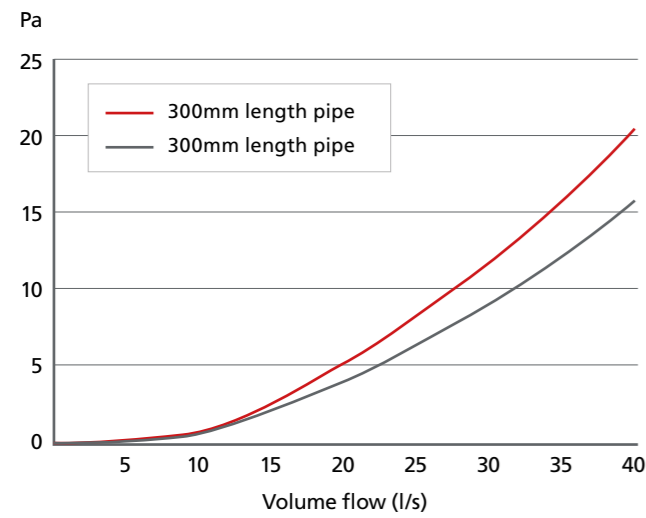

Performance data for Extract (air to outside)

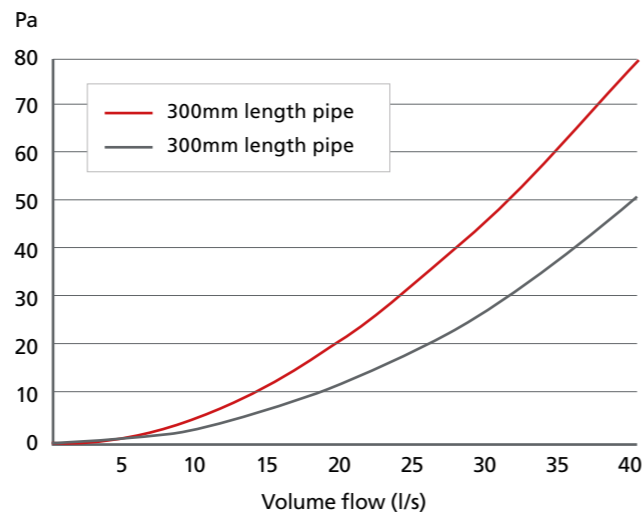

Code	Size From	To (mm)	Description	Connection	Material	Colour	Fire Standards	Manufactured to
DD030	110x54	Ø100	Fixed Socket Plenum Rectangular – Round	Female/Duct	PVC	White	UL94HB	ISO9001

Rigid Ducting | Plenums

Fixed Spigot Plenum, Rectangular to Round (110x54 – Ø100mm)



110x54 – Ø100mm

Resistance data in Pascals (Pa)								
Size	@5l/s	@10l/s	@15l/s	@20l/s	@25l/s	@30l/s	@35l/s	@40l/s
Supply – 300mm length pipe	0.3	0.8	2.0	3.6	5.4	7.5	10.6	13.6
Extract – 300mm length pipe	1.2	4.9	10.5	18.6	28.4	41.5	56.1	73.3
Supply – 2000mm length pipe	0.3	0.6	1.5	2.8	4.2	6.2	8.4	10.6
Extract – 2000mm length pipe	0.9	2.7	5.9	10.3	16.4	23.5	31.4	41.0

Performance data for Supply (air from outside)

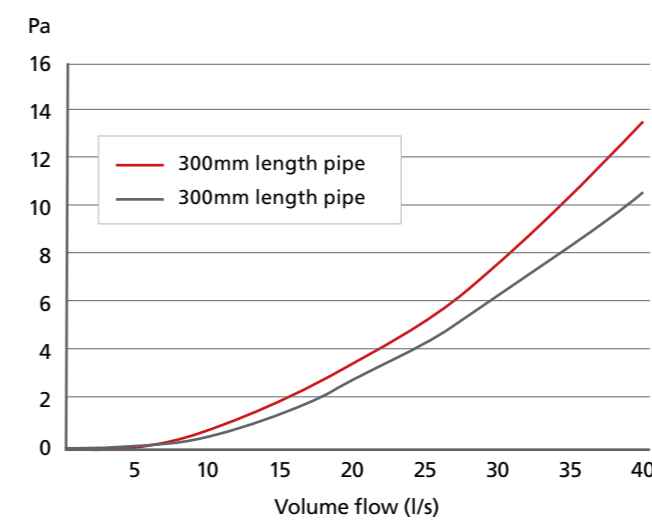

Performance data for Extract (air to outside)

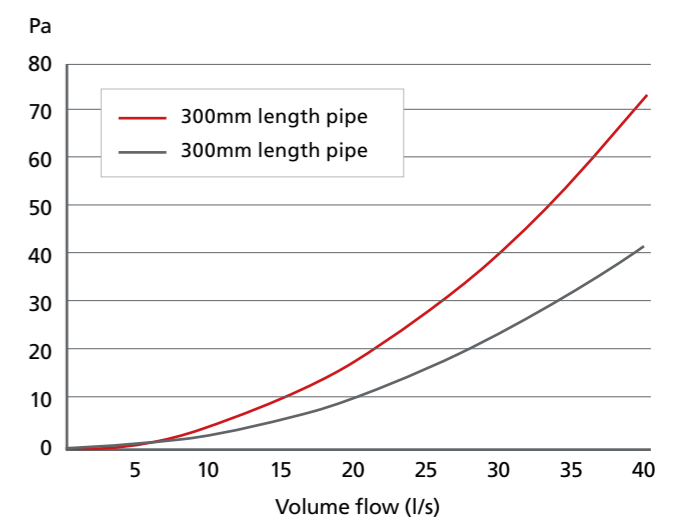

Code	Size From	To (mm)	Description	Connection	Material	Colour	Fire Standards	Manufactured to
DD040	110x54	Ø100	Fixed Spigot Plenum Rectangular – Round	Female/Male	PVC	White	UL94HB	ISO9001

Rigid Ducting | Plenums

Fixed Spigot Plenum, Rectangular to Round (204x60 – Ø125mm)



204x60 – Ø125mm

Resistance data in Pascals (Pa)								
Size	@10l/s	@20l/s	@30l/s	@40l/s	@50l/s	@60l/s	@70l/s	@80l/s
Supply – 300mm length pipe	0.8	3.0	6.5	12.3	18.4	25.4	32.8	37.1
Extract – 300mm length pipe	1.7	6.5	14.1	25.0	39.3	56.7	75.7	88.7
Supply – 2500mm length pipe	0.1	3.3	7.1	12.8	18.9	25.8	33.5	37.2
Extract – 2500mm length pipe	1.3	4.1	8.6	15.1	22.9	32.7	44.9	53.1

Performance data for Supply (air from outside)

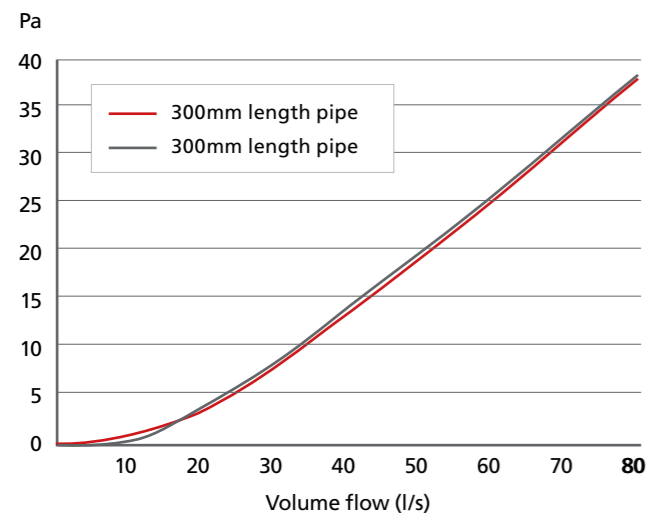

Performance data for Extract (air to outside)

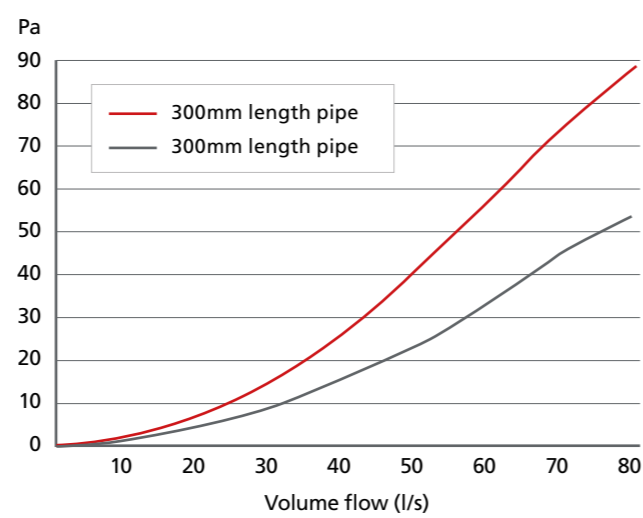

Code	Size		Description	Connection	Material	Colour	Fire Standards	Manufactured to
	From	To (mm)						
540	204x60	Ø125	Fixed Spigot Plenum Rectangular – Round	Female/Male	PVC	White	UL94HB	ISO9001

Rigid Ducting | Plenums

Fixed Spigot Plenum, Rectangular to Round (204x60 – Ø150mm)



204x60 – Ø150mm

Resistance data in Pascals (Pa)								
Size	@10l/s	@20l/s	@30l/s	@40l/s	@50l/s	@60l/s	@70l/s	@80l/s
Supply – 300mm length pipe	0.4	1.6	3.2	6.1	8.8	13.1	16.6	18.9
Extract – 300mm length pipe	1.2	4.7	10.4	18.5	28.6	40.7	54.5	68.7
Supply – 3000mm length pipe	0.4	1.1	2.0	3.0	5.0	6.8	8.5	9.7
Extract – 3000mm length pipe	0.9	3.4	7.3	12.3	19.3	28.4	38.3	47.6

Performance data for Supply (air from outside)

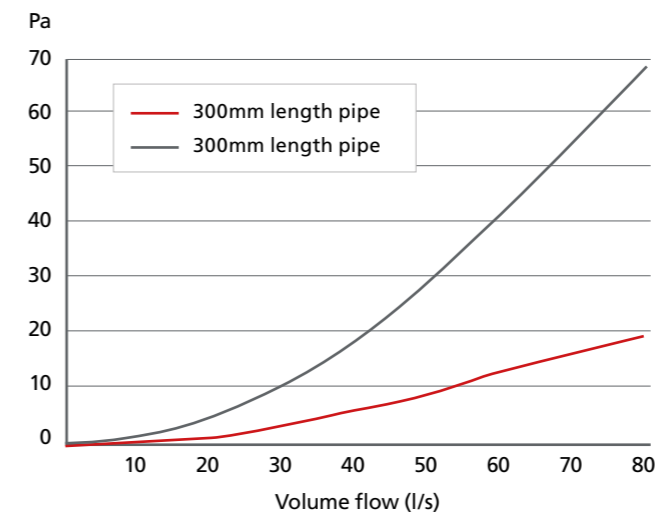

Performance data for Extract (air to outside)

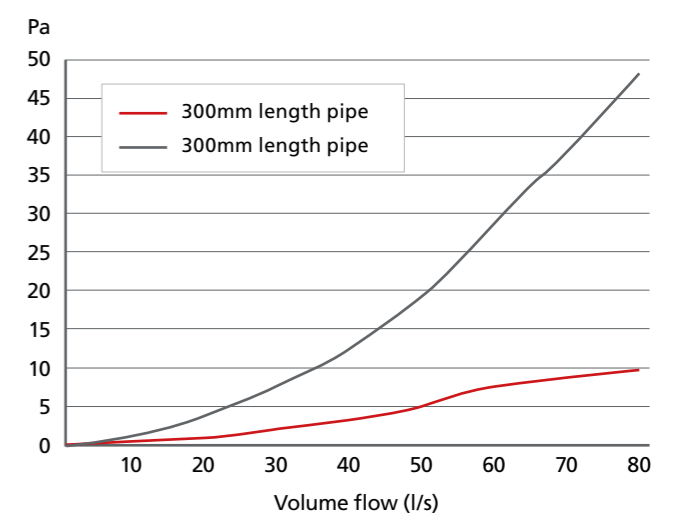

Code	Size		Description	Connection	Material	Colour	Fire Standards	Manufactured to
	From	To (mm)						
640	204x60	Ø150	Fixed Spigot Plenum Rectangular – Round	Female/Male	PVC	White	UL94HB	ISO9001

Rigid Ducting | Plenums

Offset Rotating Spigot, Rectangular to Round (204x60 – Ø100mm)



Resistance data in Pascals (Pa)						
Size	@10l/s	@20l/s	@30l/s	@40l/s	@50l/s	@60l/s
Supply (A) – 300mm length pipe	2.0	6.6	14.9	25.0	37.5	56.0
Extract (A) – 300mm length pipe	0.7	2.6	5.4	9.6	14.7	23.4
Supply (B) – 2000mm length pipe	2.9	12.1	28.9	56.9	89.1	113.8
Extract (B) – 2000mm length pipe	1.2	4.4	9.4	17.8	27.4	42.4

204x60 – Ø100mm

A = spigot furthest from socket, B = spigot nearest to socket

Performance data for Supply (air from outside)

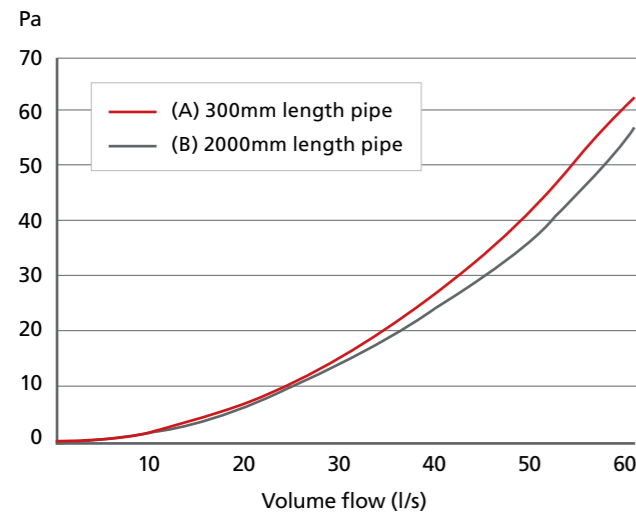

Performance data for Extract (air to outside)

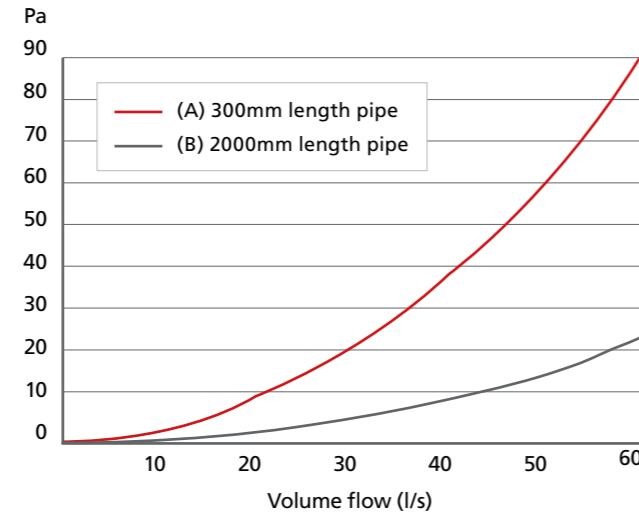

Code	Size		Description	Connection	Material	Colour	Fire Standards	Manufactured to
	From	To (mm)						
441	204x60	Ø100	Offset Rotating Spigot	Female/Male	PVC	White	UL94HB	ISO9001

Rigid Ducting | Plenums

Offset Rotating Spigot, Rectangular to Round (204x60 – Ø125mm)



Resistance data in Pascals (Pa)								
Size	@10l/s	@20l/s	@30l/s	@40l/s	@50l/s	@60l/s	@70l/s	@80l/s
Supply (A) – 300mm length pipe	0.8	3.3	6.8	12.6	18.8	25.9	33.7	38.6
Extract (A) – 300mm length pipe	1.2	4.0	8.4	14.4	22.2	32.2	43.3	51.9
Supply (B) – 2500mm length pipe	1.3	5.1	12.7	25.3	39.2	55.6	75.4	85.2
Extract (B) – 2500mm length pipe	1.2	4.4	9.7	17.2	26.2	38.1	51.7	62.1

204x60 – Ø125mm

A = spigot furthest from socket, B = spigot nearest to socket

Performance data for Supply (air from outside)

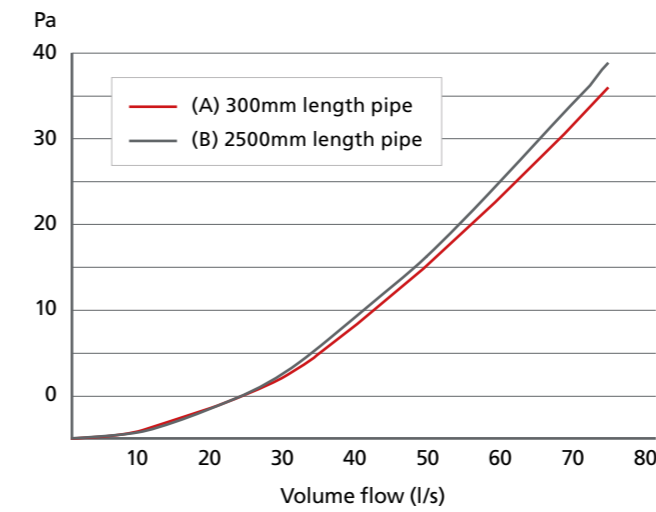

Performance data for Extract (air to outside)

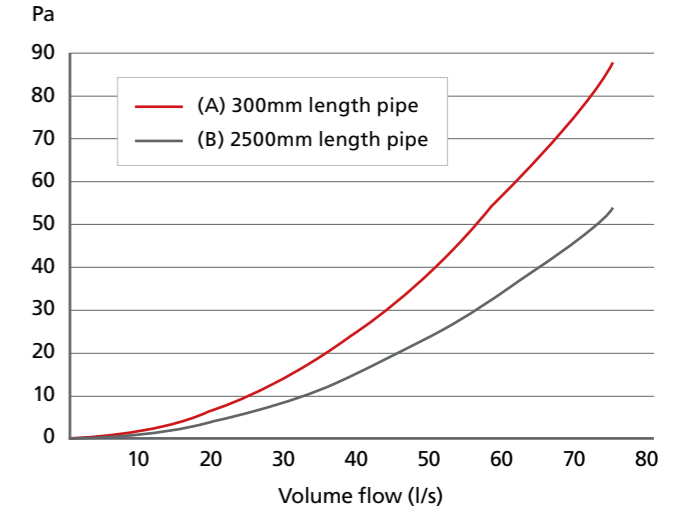

Code	Size		Description	Connection	Material	Colour	Fire Standards	Manufactured to
	From	To (mm)						
541	204x60	Ø125	Offset Rotating Spigot	Female/Male	PVC	White	UL94HB	ISO9001

Rigid Ducting | Plenums

Offset Rotating Spigot, Rectangular to Round (204x60 – Ø150mm)



204x60 – Ø150mm

Resistance data in Pascals (Pa)								
Size	@10l/s	@20l/s	@30l/s	@40l/s	@50l/s	@60l/s	@70l/s	@80l/s
Supply (A) – 3000mm length pipe	0.3	0.8	1.4	2.6	3.6	4.6	5.6	6.1
Extract (A) – 3000mm length pipe	0.8	3.0	6.3	11.0	16.9	24.5	33.7	41.2
Supply (B) – 3000mm length pipe	0.5	1.9	4.5	9.1	14.2	20.3	27.5	28.5
Extract (B) – 3000mm length pipe	0.9	3.0	6.7	11.2	17.2	25.5	34.2	42.3

A = spigot furthest from socket, B = spigot nearest to socket

Performance data for Supply (air from outside)

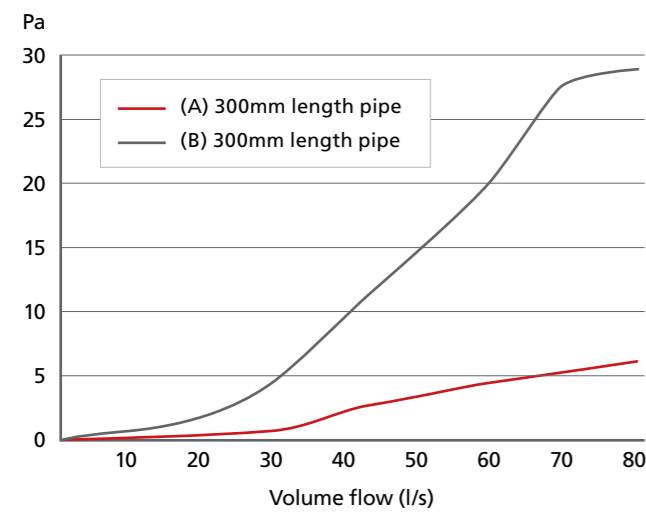

Performance data for Extract (air to outside)

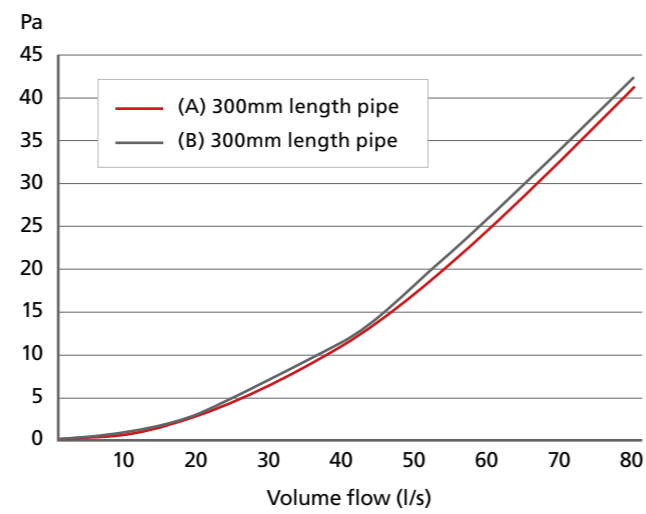

Code	Size		Description	Connection	Material	Colour	Fire Standards	Manufactured to
	From	To (mm)						
641	204x60	Ø150	Offset Rotating Spigot	Female/Male	PVC	White	UL94HB	ISO9001

Rigid Ducting | Plenums

Offset Rotating Spigot, Rectangular to Round (220x90 – Ø100mm)



220x90 – Ø100mm

Resistance data in Pascals (Pa)							
Size	@5l/s	@10l/s	@15l/s	@20l/s	@25l/s	@30l/s	@35l/s
Supply (A) – 300mm length pipe	0.6	1.9	4.3	7.9	11.8	16.9	22.8
Extract (A) – 300mm length pipe	0.1	0.2	0.4	0.8	1.1	1.7	2.0
Supply (B) – 300mm length pipe	0.5	2.9	6.4	12.2	19.3	29.6	40.0
Extract (B) – 300mm length pipe	0.2	0.8	1.6	2.9	4.6	6.7	9.2

Performance data for Supply (air from outside)

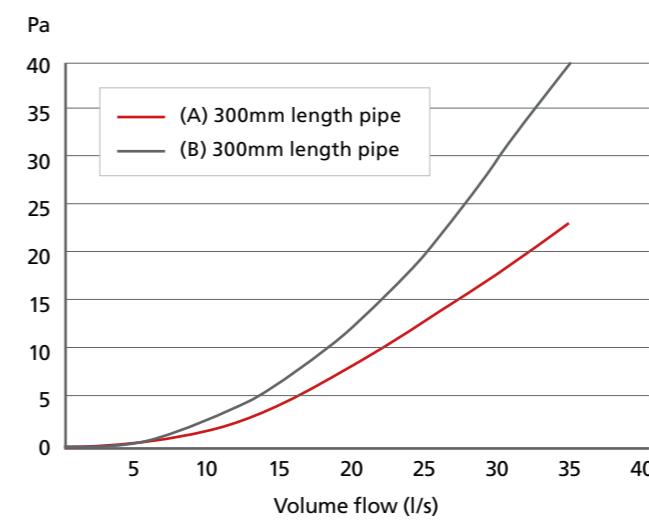

Performance data for Extract (air to outside)

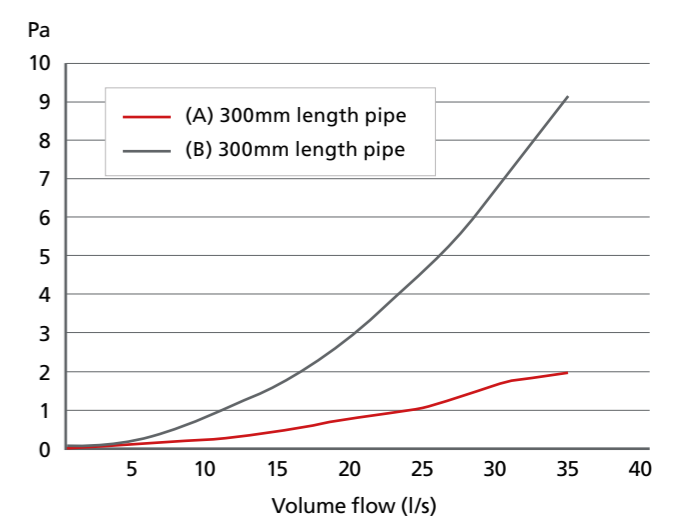

Code	Size		Description	Connection	Material	Colour	Fire Standards	Manufactured to
	From	To (mm)						
941	220x90	Ø100	Offset Rotating Spigot	Female/Male	PVC	White	UL94HB	ISO9001

Rigid Ducting | Plenums

Offset Rotating Spigot, Rectangular to Round (220x90 – Ø125mm)



220x90 – Ø125mm

Resistance data in Pascals (Pa)

Size	@10l/s	@20l/s	@30l/s	@40l/s	@50l/s	@60l/s	@70l/s
Supply (A) – 2500mm length pipe	0.9	2.8	6.4	11.0	16.7	24.5	33.2
Extract (A) – 2500mm length pipe	0.3	0.9	2.1	3.4	5.2	7.5	10.2
Supply (B) – 2500mm length pipe	1.0	4.7	10.9	20.3	33.1	49.5	66.9
Extract (B) – 2500mm length pipe	0.6	2.0	4.5	7.9	12.1	18.1	24.8

Performance data for Supply (air from outside)

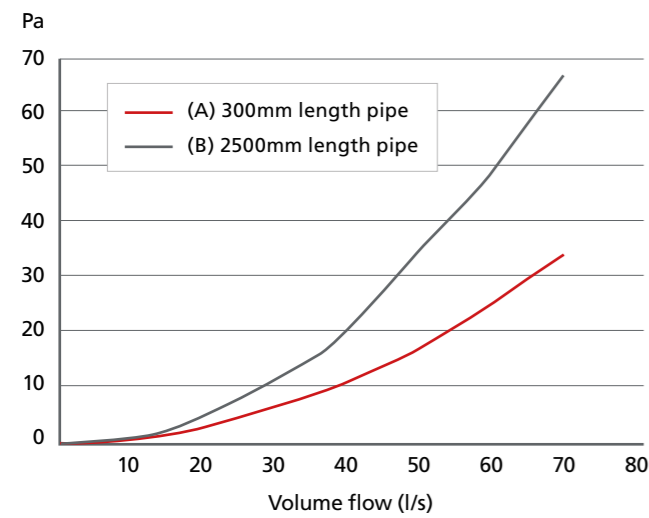

Performance data for Extract (air to outside)

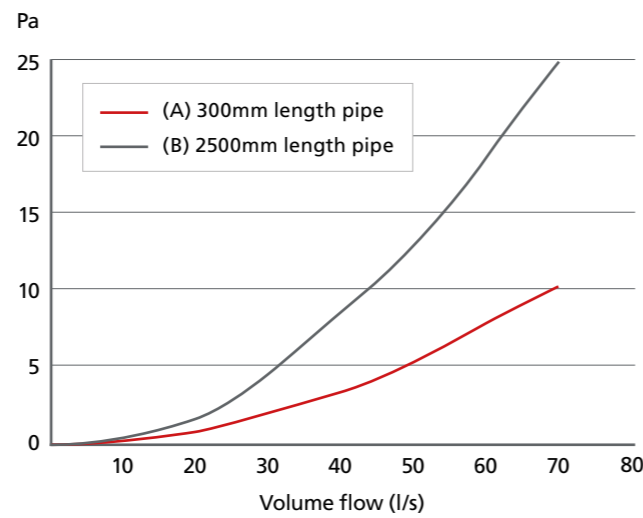

Code	Size		Description	Connection	Material	Colour	Fire Standards	Manufactured to
	From	To (mm)						
951	220x90	Ø125	Offset Rotating Spigot	Female/Male	PVC	White	UL94HB	ISO9001

Rigid Ducting | Plenums

Offset Rotating Spigot, Rectangular to Round (220x90 – Ø150mm)



220x90 – Ø150mm

Resistance data in Pascals (Pa)

Size	@10l/s	@20l/s	@30l/s	@40l/s	@50l/s	@60l/s	@70l/s
Supply (A) – 3000mm length pipe	0.3	1.2	2.8	5.0	7.7	11.2	15.4
Extract (A) – 300mm length pipe	0.7	2.6	5.7	10.3	15.6	22.5	31.0
Supply (B) – 3000mm length pipe	0.5	1.9	4.7	8.4	13.7	20.6	27.5
Extract (B) – 3000mm length pipe	0.6	1.8	4.0	6.5	10.2	14.6	19.9

Performance data for Supply (air from outside)

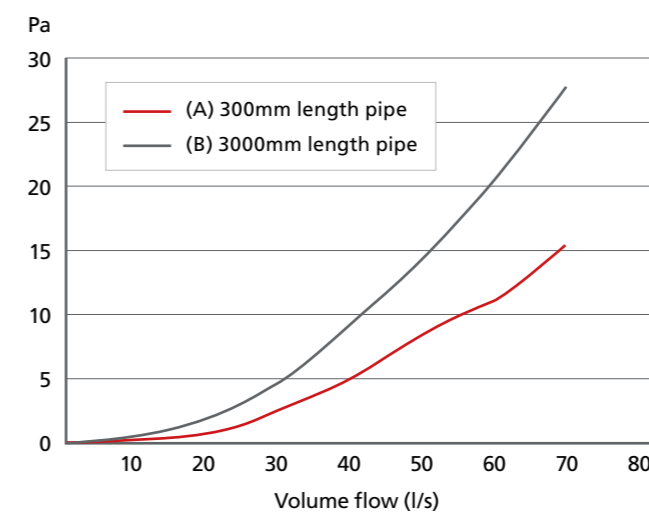

Performance data for Extract (air to outside)

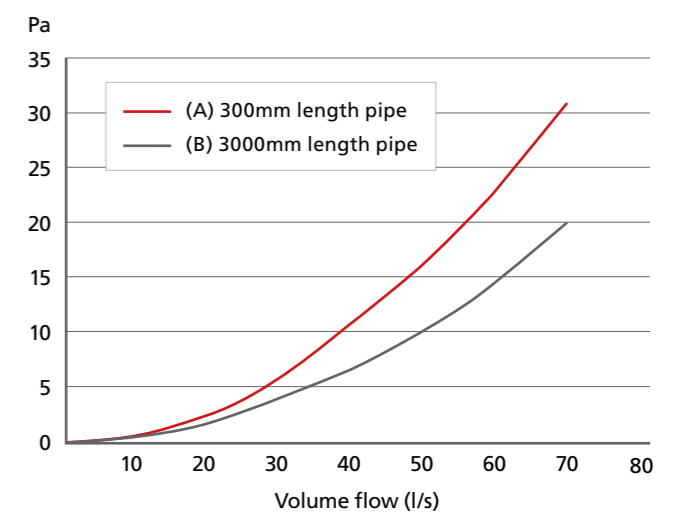

Code	Size		Description	Connection	Material	Colour	Fire Standards	Manufactured to
	From	To (mm)						
961	220x90	Ø150	Offset Rotating Spigot	Female/Male	PVC	White	UL94HB	ISO9001

► Flow Control Plenum for Architectural Grilles

Innovatively designed to include an integral flow control device; allowing connection to a range of stylish grilles and single fix commissioning.

Key features & benefits

- Allows simple connection to architectural grilles – no air valves necessary
- Enables commissioning to be carried out prior to fixing the ceiling boards
- Integral flow control device cannot be easily tampered with, thereby reducing the likelihood of impacting system performance and indoor air quality
- Commissioning rates can be agreed prior to ceilings being fixed; enabling peace of mind that the required air flow rates will be achieved (if fitted correctly) and less risk of costly remedial work
- Adjusting the air terminal for commissioning is quick and easy
- Ability to integrate stylish grilles to fit interior design scheme



Code	Description
540-FC	Domus Supertube Rigid Duct 204x60mm Flow Control Plenum for Architectural Grilles White

Performance Data

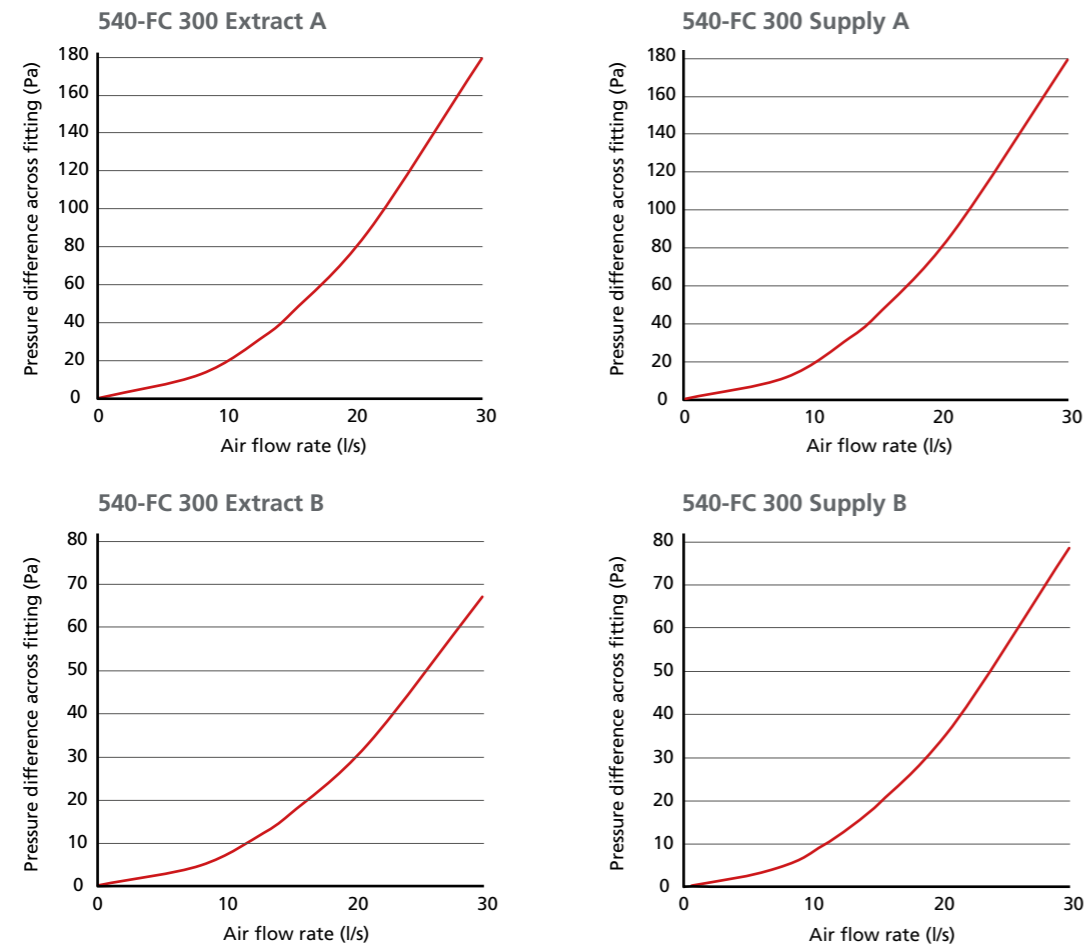

Flow Control Adjustment Kit

To help adjust the integral flow control device for commissioning and balancing, we also offer a Flow Control Adjustment Kit – code **FCAK1**.

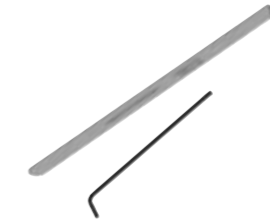

The kit contains a long reach spanner and allen key.

Code	Description
FCAK1	Domus Radial Flow Control Adjustment Kit Silver



FCAK1 in use

Architectural Grilles

Stylish bathroom and kitchen fan fascias, designed to compliment modern interior design schemes.

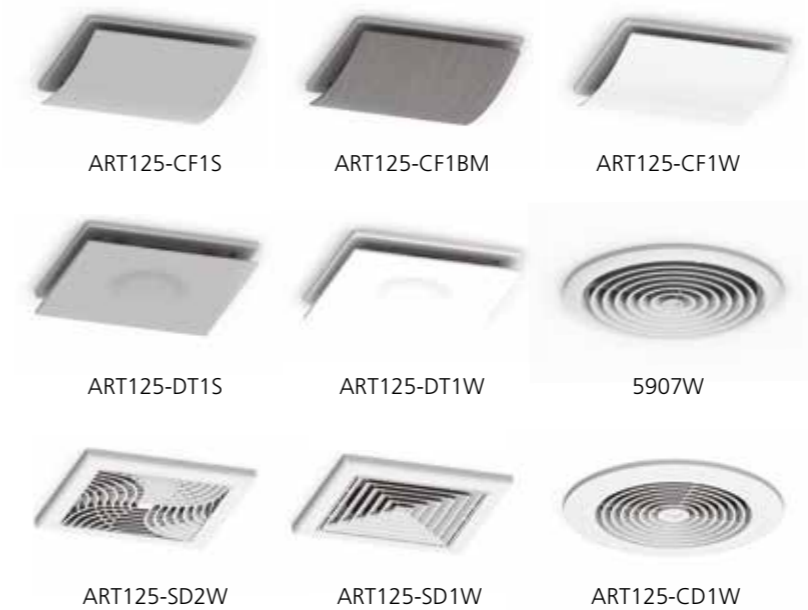

Suitable for 125mm connection.



540-FC with grille

► Flexible & Semi-Rigid

Domus Ventilation flexible and semi-rigid duct is available in all standard UK round and rectangular sizes. The range includes Hose, Insulated Hose and Aluminium Hose.

Round PVC Flexible Hose – 1m - 45m



Overview

Domus Ventilation Flexible Hose is a range of wire reinforced, flexible PVC ducting that has been specially designed for the ventilation market. The round profiles are compatible with the Domus Ventilation rigid PVC product range.

The hose provides solutions to overcome situations where a rigid component cannot be installed. Flexible hose is particularly suitable for installation where there is slow moving air, such as, the ducting of tumble driers.

Construction

The Flexible Hose is constructed as a continuous left-hand helix (English wound) on a bespoke forming "head". The reinforcing wire is 100% sealed inside a fold of PVC tape which is in turn overlapped by the next pitch. The joints are welded by hot air welding of the layers of PVC in order to produce a continuous sealed tube.

Ø100mm EasyPipe 100		Ø125mm EasyPipe 125		Ø150mm EasyPipe 150	
Free Area 7,850mm ²		Free Area 12,266mm ²		Free Area 17,263mm ²	
Code	Connection	Code	Connection	Code	Connection
Hose – 1m					
361	Female	561	Female	661	Female
Hose – 3m					
363	Female	563	Female	663	Female
Hose – 6m					
366	Female	566	Female	666	Female
Hose – 15m					
3615	Female	5615	Female	6615	Female
Hose – 45m					
3645	Female	N/A	N/A	N/A	N/A

Technical data	
Material	White PVC 70µm thick
Diameter range (mm) (internal)	100, 125, 150
Temperature range (°C)	-20/+60 working (80 max.)
Maximum air velocity	30 m/sec
Max. positive working pressure	3000 Pa
Standard length	1, 3, 6, 15, 45 metres (45m in 100mm only)
Packing	Compressed individually in net sleeve
Clamping	Domus Adjustable Round Hose Clip 100mm – 125-4 125mm – 125-5 150mm – 125-6

Aluminium/Polyester Flexible Hose – 3m - 10m



Ø100mm EasyPipe 100		Ø125mm EasyPipe 125		Ø150mm EasyPipe 150	
Free Area 7,850mm ²		Free Area 12,266mm ²		Free Area 17,263mm ²	
Code	Connection	Code	Connection	Code	Connection
Hose – 3m					
3133	Female	5133	Female	6133	Female
Hose – 6m					
3136	Female	5136	Female	6136	Female
Hose – 10m					
31310	Female	51310	Female	N/A	N/A

Key benefits

- Supplied in standard 10 metre length, compressed to 0.6 metre
- Individually boxed
- Easy to connect to either round or oval ducting
- No special tools required for cutting or fixing
- In the event of a fire, no toxic gases are emitted
- The products have been successfully fire resistance tested to BS476 parts 6, 7 and 20

Overview

The Aluminium Flexible Hose is a range of fully flexible uninsulated aluminium/polyester laminated ducting, which has been specially designed for Domus Ventilation. Due to its flexibility it is easy to connect to either round or oval ducting.

Technical data



Construction material	Reinforced Aluminium/Polyester
Wirepitch	24mm
Diameter range (mm)	100 / 125 / 150
Temperature range (°C)	-30/+140
Maximum air velocity	30m/sec
Max. positive working pressure	2500 Pa
Standard length	10 metre
Packing	Individual box of 0.6 metre
Clamping	Lightning Band, Stainless Steel Clamps, Nylon Clamps or Quick Release Clamps

Construction

The Domus Ventilation Aluminium Flexible Hose is multi-ply reinforced aluminium and polyester laminated ducting with an encapsulated high tensile steel wire helix.

Aluminium Insulated Flexible Hose – 10m



Ø100mm EasyPipe 100	Ø125mm EasyPipe 125	Ø150mm EasyPipe 150
		
Free Area 7,850mm ²	Free Area 12,266mm ²	Free Area 17,263mm ²

Key benefits

- ▶ Supplied in standard 10 metre length, compressed to 1 metre
- ▶ Individually boxed
- ▶ Easy to connect to either round or oval ducting
- ▶ No special tools required for cutting or fixing
- ▶ In the event of a fire, no toxic gases are emitted
- ▶ The products have been successfully tested for fire resistance and conforms to BS476 Parts 6 and 7

Overview

Domus Ventilation Insulated Flexible Hose is a range of fully thermally insulated ducting, which has been specially designed for the ventilation market. It has been developed to minimise heat gain or loss resulting from the temperature differential between the airflow and the surrounding ambient air. The vapour barrier prevents condensation from forming on the outside of ducts carrying air at lower temperatures than the surrounding air.

Code	Connection	Code	Connection	Code	Connection
Hose – 10m					
4210	Female	5210	Female	6210	Female



Technical data	
Insulation	16kg/m ³ Glass wool, 25mm thickness
Diameter range (mm) ww(internal)	100, 125, 150
Temperature range (°C)	-30/+150
Maximum air velocity	30 m/sec
Max. positive working pressure	3000 Pa
Standard length	10 metre
Packing	Individual box compressed to 1m
Clamping	Domus Ventilation Adjustable Round Hose Clip 100mm – 125-4 125mm – 125-5 150mm – 125-6

Construction

Domus Ventilation Insulated Flexible is produced from multi-layer aluminium and metallized polyester, strengthened with high tension hard steel spring wire, surrounded with glass wool insulation and an aluminium vapour barrier.

Aluminium Flexible Duct – 0.3m - 3m



Ø100mm EasyPipe 100	Ø125mm EasyPipe 125	Ø150mm EasyPipe 150
		
Free Area 7,850mm ²	Free Area 12,266mm ²	Free Area 17,263mm ²

Key benefits

- ▶ Constant cross section for predictable air flow characteristics
- ▶ Reduced need for supports on longer duct runs
- ▶ Fire resistant to BS 476 Part 8 with negligible smoke generation
- ▶ Extra flexibility. Ideal for short final connections
- ▶ Supplied in compressed lengths and individually boxed for site protection, easy handling and storage

Overview

For years the designer's need for a fire resistant flexible duct has been hampered by the lack of flexibility and fragile nature of metallic ducting. Now Domus Ventilation Aluminium Flexible Duct overcomes these problems.

Aluminium Flexible Duct is a corrugated flexible ducting, which can be formed to bend radii less than 1/2D. It is supplied in its compressed state but when installed the tube extends to 4 metres for maximum flexibility and economy – making it the simple answer to many flexible duct problems.

Code	Connection	Code	Connection	Code	Connection
Hose – 0.3m					
403203	Female	503203	Female	603203	Female
Hose – 1.5m					
403215	Female	503215	Female	603215	Female
Hose – 3m					
403230	Female	503230	Female	603230	Female

Flexible

It is available in 100mm, 125mm and 150mm diameter and may be hand-formed to bends of less than a 1/2D Radius- a feature previously only thought possible with fabric flexibles.

Aluminium Flexible Duct can also be extended or compressed easily for installation between spigots located opposite to each other. It is ideal for final connections or where space is limited.

Strong

Strength and pliability in metal flexibles are affected by the thickness, corrugation shape and ductility of the material used in construction. In the past a strong tube has lacked flexibility and flexible tube has lacked strength.

With Aluminium Flexible Duct the problems are overcome by producing a deep corrugation tube, which is kept in the compressed state until it is installed; in this state it has great strength with little flexibility. At the time of installation, when strength is a lower priority, the tube is extended to achieve its ultimate in flexibility.

Self supporting

Aluminium Flexible Duct retains its corrugation form in use and in doing so achieves maximum distance between supports without sagging, resulting in cost savings in labour and materials when compared to fabric flexible.

It also retains its cross section regardless of its state; it can be compressed, extended, or formed into bends or offsets with no reduction in area.

This means that frictional resistance figures are constant and air flow figures can be accurately predicted at the design stage.

The tube is stable after forming with no tendency to spring back, thus forces on spigots are kept to the very minimum.

Fire resisting

Aluminium Flexible Duct is tested to BS476 Part 6, 7 and 8, and meets the requirements for CP413 section A2.2.3 (Ducts for Building Services) and is suitable for use throughout the U.K. and the Continent. When tested to BS476 Part 7 a class 1 spread of flame was recorded. When tested under the conditions laid down in BS476 Part 8 Aluminium Flexible Duct maintained its integrity for 15 minutes. As it is of all metal construction smoke generation is negligible.

Aluminium Hose Clip – 100, 125 and 150mm (for installation with Domus Flexible Hose)



Overview

The Aluminium Duct Clips are designed to provide a secure, air-tight connection. The range also includes Universal Connectors, offering greater installation flexibility.

Ø100mm EasyPipe 100

Free Area 7,850mm²

Code	Connection
125-4	90-110mm

Ø125mm EasyPipe 125

Free Area 12,266mm²

Code	Connection
125-5	110-130mm

Ø150mm EasyPipe 150

Free Area 17,263mm²

Code	Connection
125-6	140-160mm

Aluminium Universal Hose Clip – 100, 125 and 150mm (for installation with Domus Flexible Hose)



Overview

The Aluminium Duct Clips are designed to provide a secure, air-tight connection. The range also includes Universal Connectors, offering greater installation flexibility.

Ø100mm EasyPipe 100

Free Area 7,850mm²

Code	Connection
125-4	90-110mm

Ø125mm EasyPipe 125

Free Area 12,266mm²

Code	Connection
125-5	110-130mm

Ø150mm EasyPipe 150

Free Area 17,263mm²

Code	Connection
125-6	140-160mm

Round Flexible Hose Connectors

Our flexible hose connectors are designed to achieve the highest possible energy efficiency from our ventilation appliances.

They are manufactured from exacting tolerances to virtually eliminate air leakage and reduce pressure drop.

Ø100mm EasyPipe 100

Free Area 7,850mm²

Ø125mm EasyPipe 125

Free Area 12,266mm²

Ø150mm EasyPipe 150

Free Area 17,263mm²

Round Flexible Hose Connectors – 0.1m



Code	Connection
Hose – 0.1m	
380	Male

Code	Connection
Hose – 0.1m	
580	Male

Code	Connection
Hose – 0.1m	
680	Male

Round Flexible Hose Connectors – With Threaded Socket



Code	Connection
126-4	Female

Code	Connection
126-5	Female

Code	Connection
126-6	Female

Round Flexible Hose Connectors – With Threaded Spigot



Code	Connection
124-4	Male

Code	Connection
N/A	N/A

Code	Connection
N/A	N/A

Rectangular Flexible PVC Hose – 0.5m - 3m



Overview

Domus Ventilation Flexible Hose is a range of wire reinforced, flexible PVC ducting that has been specially designed for the ventilation market.

The hose provides solutions to overcome situations where a rigid component cannot be installed.

Flexible hose is particularly suitable for installation where there is slow moving air, such as, the ducting of tumble driers.

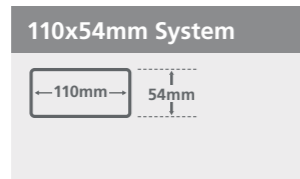

Code	Connection
Hose – 0.5m	
3305	Female
Hose – 3m	
333	Female

Construction

The Flexible Hose is constructed as a continuous left-hand helix (English wound) on a bespoke forming "head". The reinforcing wire is 100% sealed inside a fold of PVC tape which is in turn overlapped by the next pitch. The joints are welded by hot air welding of the layers of PVC in order to produce a continuous sealed tube.

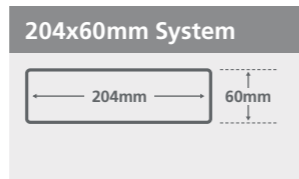

Code	Connection
Hose – 0.5m	
5305	Female
Hose – 3m	
533	Female

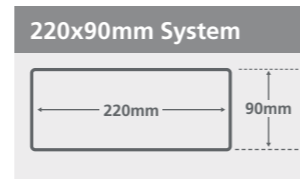

Code	Connection
Hose – 0.5m	
9305	Female
Hose – 3m	
933	Female

Technical data	
Material	White PVC 70µm thick
Sizes mm (internal)	110x54, 204x60, 220x90
Temperature range (°C)	-20/+60 working (80 max.)
Standard length (m)	0.5, 3
Packing	Compressed individually in net sleeve
Clamping	D-TIE Nylon zip-tie

Rectangular Flexible Hose Connectors – 0.1m and 0.14m



Designed to achieve the highest possible energy efficiency from our ventilation appliances.

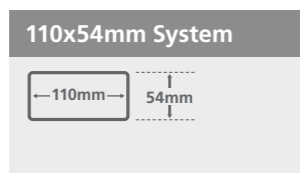

Code	Connection
Length – 0.1m	
381	Duct

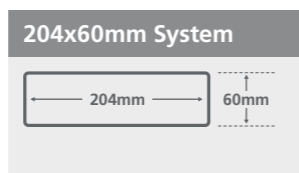

Code	Connection
Length – 0.1m	
581	Duct

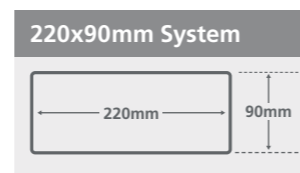

Code	Connection
Length – 0.14m	
981	Duct

► Ducting Ancillaries

Alongside our ventilation systems and ducting, we offer a range of ancillary items.

Rigid Duct Aluminium Duct Tape – 45m & 100m



Overview

A 30 Micron soft tempered bright aluminium foil. Coated with high tack pressure adhesive which has excellent UV light resistance on a white glassine liner.

This product is recommended where a moisture barrier and cold weather performance is required.

Code	Length
50TP45	45m
50TP100	100m

Technical data	Typical values
Adhesive colour:	Clear
Adhesive type:	Acrylic UV Light resistance
Tape thickness:	0.060mms (without liner)
Foil thickness:	0.030mms
Peel adhesion to steel:	1000N/M
Loop tack:	800N/M
Shear (static):	87 Hours @ 1kg
Fire protection:	Conforms to Class O BS476 part 7 & 6 1987
Minimum applic temp:	0°C
Service range:	-20°C to 120°C
Shelf life:	12 months (PSMA Conditions)

PVC Duct Tape (non flame retardant) – 4.6m & 33m



Applications

- Jointing of polythene sheeting
- Barrier tape to prevent electrolytic reaction
- Sealing insulation panels
- Patching, sealing (boxes, drums, kegs) repair

Code	Length
123-4	4.6m
123	33m

Technical data	Typical values
Total thickness:	0.14 mm
Adhesive power:	200N/m
Backing thickness:	-
Tensile strength:	2KN/m
Elongation:	200%
Temperature:	-20°C to 80°C
Dielectric strength:	6KV
Colours:	Black, White, Grey
Shelf life:	12 months

Warranties

The above figures are average values and should not be regarded as maximum or minimum values for specification purpose.

The purchaser shall be responsible for determining the suitability of this purpose. Goods which prove to be defected through

faulty material or workmanship must be returned to us carriage paid. These will be replaced or credited. We shall not be liable for consequential damage incurred in the use of this material. All slitting and length tolerances are to British Standards, but other tolerances are available by request.

Rigid Duct Intumescent Sealant – available in 310ml size



Code
DDSEAL

Description

DDSEAL sealant is a waterborne one-part fire-resistant and acoustic rated joint sealant which provides a firm, yet flexible seal to joints in a wide variety of fire-rated structures where fire resistance up to 4 hours is required. Its special intumescent properties cause the sealant to swell up and char in the presence of heat, preventing the spread of smoke and fire through the joint.

Uses

- ▶ Sealing joints, voids and irregular holes where fire resistance up to 4 hours is required
- ▶ Ideal for sealing joints, voids and irregular holes in fire walls, partitions, door architraves, service penetrations, floors and other structures
- ▶ For bedding of hinges and locks in fire doors
- ▶ For perimeter sealing of internal, fire rated screens, partitions, service penetrations and door or window frames
- ▶ To maintain integrity when sealing around pipes, services and cable
- ▶ Sealing fire rated ductwork

Key features

- ▶ Good adhesion to timber, plasterboard, masonry, blockwork, plaster, concrete and many other common building surfaces
- ▶ Up to 4 hours fire resistance
- ▶ Over-paintable with solvent and water based paints
- ▶ Suitable for horizontal and vertical joints without compromising fire rating performance
- ▶ For use in joints up to 50mm
- ▶ Water based, solvent & halogen free, water clean up
- ▶ Reduces sound transmission in joints
- ▶ Formulated using a special acrylic emulsion to provide a firm seal whilst retaining a degree of flexibility
- ▶ Joint movement capability of ±12.5%
- ▶ Will not support combustion
- ▶ Colour: white

Technical approvals

DDSEAL conforms to the following standards:
Fire Performance
 BS 476:Part 20:1987.
 BS EN 13666-3 with additional guidelines from BS EN 1366-4
Acoustic Performance:
 Tested in accordance with BS EN ISO 140-3:1995
Sealant Classification ISO 11600 Classification:
 F-12.5-P

Technical data	Typical values
Adhesion:	Good adhesion when applied to wood, plaster, plasterboard, blockwork
Base technology:	Acrylic emulsion
Chemical resistance:	Fair to dilute acids and alkalis
Curing system:	Dries through evaporation
Hardness (Shore A 25°C):	50
ISO 11600 classification:	F-12.5-P
Mould resistance:	Contains a fungicide
Movement accommodation:	±12.5%
Paintability:	Can be overpainted.
Service life (predicted):	20 years
Service temperature range:	-15°C to +70°C
Shrinkage:	<25%
Specific gravity:	1.56 - 1.60g/cm3
Slump:	Nil
Staining:	Nil
UV resistance:	Good
Volatile content:	<25%
Acoustic rating:	40(-3;-8)dB Rw(C;CTr) BS EN ISO 717-1:1997

Rigid Duct Acrylic Sealant – available in 310ml size



Code
DASEAL

Description

DASEAL is a high performance emulsion acrylic sealant based on the latest developments in acrylic elastomer technology. It has been specially formulated for sealing around window frames, skirtings, architraves and general small gap filling.

It offers a degree of flexibility whilst still retaining the ability to be easily overcoated with conventional paints. Although primarily used internally, it has good external performance when applied in suitable conditions.

Technical approvals

DASEAL is a high performance sealant which conforms to ISO 11600 - F-12.5P.

Key features

- ▶ Good adhesion to a wide variety of surfaces including PVC, timber and brickwork
- ▶ Easy to apply and finish
- ▶ Can be overpainted within 1 - 2 hours with both water and solvent borne paints
- ▶ Quick drying – forms a skin within 15 minutes internally
- ▶ Contains a high level of fungicide for long term decorative appearance
- ▶ Colours: Brown & white

Uses

- ▶ For sealing internal joints around window and door frames, skirting boards, coving and dado rails
 - ▶ Sealing cracks in plaster
 - ▶ Perimeter pointing of windows and doors
 - ▶ External low to medium movement joints between brick, concrete and timber
- Note: Ensure that the conditions are suitable to allow the development of a substantial skin before exposure to rain, typically a minimum of 4 hours.

Technical data	Typical values
Adhesion:	Moderate to good adhesion to timber, PVC, plasterboard and plywood
Base technology:	Acrylic polymer
Chemical resistance:	Fair to dilute acids and alkalis
Curing system:	Evaporation
Hardness (Shore A 25°C):	Approx 50
Mould resistance:	Contains a fungicide
Movement accommodation:	±12.5%
Paintability:	Easily overpainted
Service life (predicted):	15 years
Service temperature range:	+5°C to +30°C
Shrinkage:	< 20%
Specific gravity:	1.62 to 1.66 g/cm3
Slump:	Nil: (up to 20mm x 10mm vertical channel)
Staining:	Nil
UV resistance:	Good
Volatile content:	< 20%

► Domus Radial

Whole house air distribution systems, which provide simple, quick and hassle free installation, to save time and money.

Domus Radial systems are a clever plug and play whole house ventilation solution, which use manifold distribution to evenly service each room through semi-rigid duct. These systems incorporate a centralised mechanical unit; either a Mechanical Ventilation with Heat Recovery (MVHR) or Mechanical Extract Ventilation (MEV).



What is different about Domus Radial?

- Slimline manifold (125mm deep) enables easy installation between joists or in tight spaces, where required for larger developments
- Optional integral flow control device allows the outlet plenum to be connected directly to a stylish architectural grille – no air valve necessary
- Rapid fixing mechanism enables secure and air-tight connection with no leakages

- Corrugated construction and the unique formulation of semi-rigid duct resists stress cracking and on-site damage



- Can integrate with Domus rigid duct systems to create versatile hybrid solutions
- Fire-stopping and insulation components also available

i Tested by the **Building Research Establishment (BRE)** for inclusion within the Product Characteristics Database, Domus Radial offers performance levels that not only are the equivalent to traditional rigid ducting in smaller builds but also exceed these levels in properties with four or more wet rooms.

Our award winning Domus Radial semi-rigid duct systems provide simple, quick and hassle free design and installation which saves time and money, whilst maximising in-situ performance.



Key benefits

- Radial duct is up to 60% quicker and easier to install, against traditional, saving you time and money
- Easy to order pre-selected house packs enable straightforward specification and selection
- Eliminates room-to-room cross talk, for a quieter home
- Simplified design layout makes the system ideal for new and refurb projects
- Increased air capacity for reduced air noise, low duct losses and improved appliance efficiency
- Ability to integrate stylish architectural grilles, to fit interior design scheme



Domus Architectural Grilles

Domus Radial duct with a Flow Control Plenum, connecting to a stylish grille

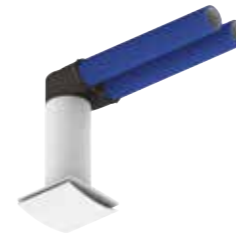

Domus Radial duct with Fire Protection Sleeve



Domus Radial duct with Insulation



Easy Adjustment of Domus Flow Control Plenum



A Domus Radial Flow Control Plenum will allow the integration of stylish Domus grilles

Installation

The simple plug and play mechanism between the semi-rigid duct and manifold, as well as the plenum's clip-on fixing system, make Domus Radial ultra-quick to install. As directed in our simple online step-by-step installation guide, the only tools you will require are:

- Pozidrive screw driver
- Long reach spanner*
- Cutting tool
- Allen key*

*Provided as part of architectural house packs only. Also sold as part of a kit on code FCAK1.



Domus Radial is available as pre-selected house packs as well as individual parts.



The Domus Radial range

Product	Code	Description	Product	Code	Description
	RDD75(25)	Semi-Rigid Duct, Ø75mm - 25m Coil		RDCLIP75	Duct Clips, Ø75mm – Pack of 10
	RDD75	Semi-Rigid Duct, Ø75mm - 50m Coil		RDPC75	Manifold Protective Caps
	RDD7590	Semi-Rigid 90 degree duct connector 75mm		RDFS75	Semi-Rigid Duct Fire-Stopping Sleeve
	RDC75	Semi-Rigid duct connector 75mm		RDI-25X5M	Insulation for Ø75mm Semi-Rigid Duct
	RDM-EP150	Manifold (Round)		RDOP-125	Plenum (2x75mm)
	RDM-MD220	Manifold (Rectangular)		RDOP-125FC	Plenum plus flow control (2x75mm)
	RDLAB	Manifold Extract and Supply Label Kits			

Domus Adapt



Domus Adapt is a unique duct solution, which will allow for simple, straightforward connection between PCDB listed Domus Radial semi-rigid and Domus rigid duct systems with minimal effort.

Designed to lower project costs, whilst also reducing duct installation time by up to 25%; Domus Adapt has innovatively evolved Radial semi-rigid duct systems, to make installing whole house ventilation, EASIER and MORE COST EFFECTIVE than ever before.

No typical void space is too tight or duct run too complicated for Domus Adapt, with options available to suit a variety of configurations and installations.

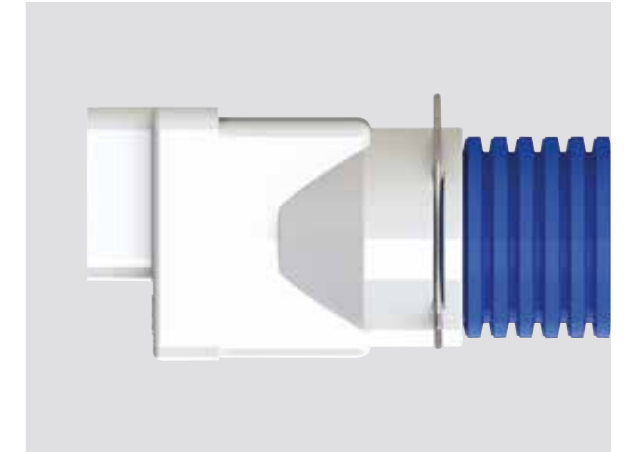

Key features & benefits

- ▶ Ideal for apartments or cluster developments, such as care homes and student accommodation*
- ▶ Will remove the need for a manifold; lowering installation costs and time
- ▶ Helps prevent complicated duct runs, providing simpler design and installation
- ▶ Lowers project costs
- ▶ A versatile solution to help overcome issues associated with a lack of installation space or tight void areas
- ▶ Simplifies installation, to overcome site constraints and space restrictions
- ▶ Reduces installation time
- ▶ Domus Radial is a simple plug-and-play, labour saving duct system, which takes away the need for traditional jointing
- ▶ Allows installers to run straight into Domus Radial semi-rigid Ø75mm duct; no need for tape, screws or sealant
- ▶ Manufactured in the UK
- ▶ Allows for a variety of duct configurations
- *Capable of achieving up to 30l/s per fitting.
- ▶ Provides a complete ducting solution, including the ducting for supply and extract when supporting a kitchen plus two wet rooms

Fittings

The Domus Adapt range includes T pieces, In-line Adapters, Elbows and Bends, available to install with a MVHR or MEV appliance. All pressure loss figures have been tested by the Building Research Establishment (BRE).

Integrate within your Domus duct system to overcome space restrictions or branch out from your chosen appliance.

HRX Mechanical Ventilation with Heat Recovery (MVHR) Range & Domus Adapt

Domus Adapt can be seamlessly installed with the HRX Mechanical Ventilation with Heat Recovery range, allowing fitters to ADAPT straight into Domus Radial duct, removing the need for expensive manifolds. Units are available with a Bluebrain controller, for enhanced user control and air comfort.



No manifold is required – just simply ADAPT straight out into Domus Radial.

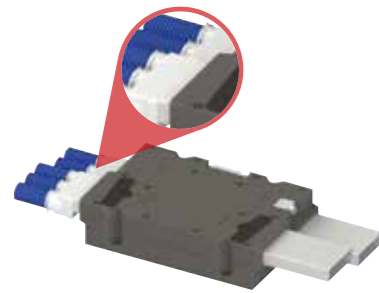

HRX-aQ, ideal for ceiling/void applications in a floor area up to 80m²

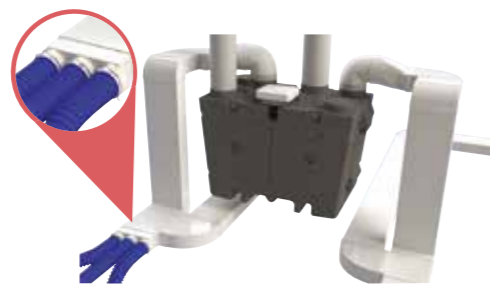

HRX2D, for installation in a floor area up to 250m²

Domus Adapt is the perfect whole house ventilation solution for kitchen plus two wet rooms. For more information on MVHR go to www.domusventilation.co.uk or email vent.marketing@domusventilation.co.uk

CMX-S Mechanical Extract Ventilation (MEV) with Domus Adapt

As a versatile solution, the CMX-S Mechanical Extract (MEV) appliance is available with Domus Adapt, for a straight in and out Radial duct run.

- Code:** CMX-S
- Socket Size:** 220x90mm
- Radial Duct Socket Size:** Ø75mm
- Includes:** CMX-S MEV unit, 1 blanking cap, 3 seals and 3 clips
- Performance data on CMX-S MEV:** see page 15



Allows for MEV installation in even the most restrictive of spaces.

Domus Adapt T Pieces



3 T-Pieces available in the range which seamlessly incorporate 220x90mm rigid duct and Ø75mm Radial from a centralised mechanical ventilation unit.

Option 1	Option 2	Option 3
----------	----------	----------

Connect into 6 x Ø75mm Domus Radial duct runs.
Code: RDA-6T
T Piece Socket Size: 220x90mm
Radial Duct Socket Size: Ø75mm
Includes: 4 blanking caps, 6 clips and 6 seals

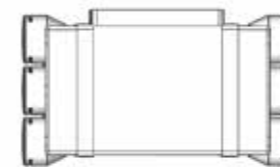

Pressure Drop (Pa)	Airflow Rate (l/s)		
	10.0	20.0	30.0
Supply	1.0	2.7	5.2
Extract	-0.7	-1.4	-2.2

Connect into 6 x Ø75mm Domus Radial duct runs.
Code: RDA-6TB
T Piece Socket Size: 220x90mm
Radial Duct Socket Size: Ø75mm
Includes: 4 blanking caps, 6 clips and 6 seals

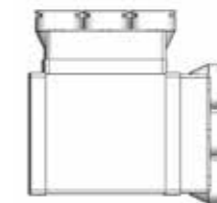

Pressure Drop (Pa)	Airflow Rate (l/s)		
	10.0	20.0	30.0
Supply	1.1	3.3	6.5
Extract	-0.6	-1.1	-1.9

Connect into 3 x Ø75mm Domus Radial duct runs.
Code: RDA-3T
T Piece Socket Size: 220x90mm
Radial Duct Socket Size: Ø75mm
Includes: 2 blanking caps, 3 clips and 3 seals

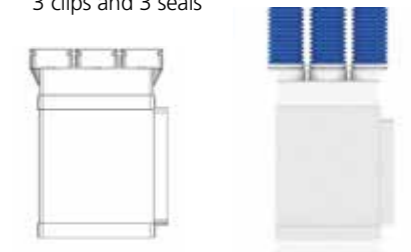

Pressure Drop (Pa)	Airflow Rate (l/s)		
	10.0	20.0	30.0
Supply	0.6	1.5	2.6
Extract	-0.4	-1.0	-1.8

Figures represent a 50% flow rate through the Radial duct.

Domus Adapt In-Line Adapters



With 3xØ75mm Radial Sockets
 This range offers adaptors which convert a system's duct from standard uPVC to Domus Ventilation Radial.

Option 1	Option 2
----------	----------

Connect into 3 x Ø75mm Domus Radial duct runs.
Code: RDA-3FA
In-line Socket Size: 204x60mm
Radial Duct Socket Size: Ø75mm
Includes: 2 blanking caps, 3 clips and 3 seals

Pressure Drop (Pa)	Airflow Rate (l/s)				
	8.0	13.0	15.0	21.0	30.0
Supply	-0.3	-0.2	-0.2	1.6	2.7
Extract	1.0	2.2	2.7	5.3	10.3

Connect into 3 x Ø75mm Domus Radial duct runs.
Code: RDA-3FC
In-line Socket Size: 220x90mm
Radial Duct Socket Size: Ø75mm
Includes: 2 blanking caps, 3 clips and 3 seals

Pressure Drop (Pa)	Airflow Rate (l/s)				
	8.0	13.0	15.0	21.0	30.0
Supply	0.1	0.6	1.0	2.2	4.3
Extract	0.6	1.3	1.7	3.5	6.5

Domus Adapt Plenum

With 3xØ75mm Radial Sockets

The plenum, also known as an 'elbow bend' integrates Ø150mm rigid duct with Ø75mm Domus Ventilation Radial in one, straight forward connection with minimal effort. All pressure loss figures have been tested by the Building Research Establishment (BRE).



RDA-3R90-125

Connect into 3 x Ø75mm Domus Radial duct runs.

Elbow Spigot Size: Ø125mm
Radial Duct Socket Size: Ø75mm
Includes: 2 blanking caps, 3 clips and 3 seals

Pressure Drop (Pa)	Airflow Rate (l/s)				
	8.0	13.0	15.0	21.0	30.0
Supply	0.5	1.4	1.7	3.7	7.3
Extract	1.5	2.9	3.7	7.2	14.3

RDA-3R90-150

Connect into 3 x Ø75mm Domus Radial duct runs.

Elbow Spigot Size: Ø150mm
Radial Duct Socket Size: Ø75mm
Includes: 2 blanking caps, 3 clips and 3 seals

Pressure Drop (Pa)	Airflow Rate (l/s)				
	8.0	13.0	15.0	21.0	30.0
Supply	0.6	1.3	1.8	3.9	7.3
Extract	1.1	1.9	2.3	4.8	9.7

Domus Adapt Horizontal 90° Bend

With 3xØ75mm Radial Sockets

The RDA-3FH90 combines 220x90mm PVC and Ø75mm Radial at a 90 horizontal bend.



Connect into 3 x Ø75mm Domus Radial duct runs.

Code: RDA-3FH90
Bend Socket Size: 220x90mm
Radial Duct Socket Size: Ø75mm
Includes: 2 blanking caps, 3 clips and 3 seals

Pressure Drop (Pa)	Airflow Rate (l/s)				
	8.0	13.0	15.0	21.0	30.0
Supply	0.3	0.8	1.2	2.7	5.3
Extract	0.7	1.5	1.9	4.1	7.9

Domus Adapt Vertical 90° Bend

With 3xØ75mm Radial Sockets

The RDA-3FV90 combines 220x90mm PVC and Ø75mm Radial at a 90 vertical bend.



Connect into 3 x Ø75mm Domus Radial duct runs.

Code: RDA-3FV90
Bend Socket Size: 220x90mm
Radial Duct Socket Size: Ø75mm
Includes: 2 blanking caps, 3 clips and 3 seals

Pressure Drop (Pa)	Airflow Rate (l/s)				
	8.0	13.0	15.0	21.0	30.0
Supply	0.4	1.0	1.4	3.2	5.6
Extract	0.7	1.6	2.0	4.2	8.3

Domus Adapt Spares Pack

Blanking Plates, Clips and Seals

Whilst 'House Packs' are available, which provides an estimated system requirement for average plots, Domus Ventilation also offer Spares Packs which ensure you have enough fixings on-site, at a minimal cost.



Option 1

Code: RDA-CSK3
Includes: 2 blanking caps, 3 clips and 3 seals

Option 2

Code: RDA-CSK6
Includes: 4 blanking caps, 6 clips and 6 seals

Domus Adapt Fire Sleeve Kit

The RDA-FSK is a Fire Sleeve designed specifically for use with the Adapt range and exceeds all Fire Regulations needed for both new-build and refurb projects. It is quick and easy to install. Please contact us for availability of other sizes.



Code: RDA-FSK
Size: 204x60mm

► Thermal Duct Insulation

As an integral part of Domus rigid duct systems, Domus Thermal is a unique and patented duct insulation system, designed specifically to radically improve the thermal insulation of rigid ducting in domestic properties.



What is Domus Thermal?

- ▶ A range of EPS insulation components specifically designed to insulate round or rectangular domestic ventilation ducting passing through cold areas.
- ▶ A method of significantly reducing heat loss and virtually eliminating the formation of condensation.
- ▶ The first engineered duct insulation system available to comply with recent improvements to Building Regulations.

- ▶ An installer-friendly solution which can be fitted quickly and reliably without the need for gluing or taping.

Why use Domus Thermal?

- ▶ Approved Document F of Building Regulations 2010 states that all ducting installed in domestic properties, which passes through unheated areas or loft spaces, should be insulated with the equivalent of at least 25mm of a material having a thermal conductivity of ≤ 0.04 W/(m.K) to reduce the possibility of condensation forming.
- ▶ The loss of heat through poorly insulated duct systems means that modern homes are at risk of losing a valuable source of energy; for example, when using warm exhaust air to heat fresh incoming air through an MVHR system or exhaust air heat pump.
- ▶ Domus Thermal exceeds these regulations, having a thermal conductivity of 0.03 W/(m.K), thus providing better insulation and peace of mind that the system will be compliant and save energy. This greatly improved thermal conductivity allows the wall thickness to be reduced to just 20mm in most profiles.

What is different about Domus Thermal?

Complies with Building Regulations

The only engineered duct insulation solution which complies with 2010 Building Regulations. The thermal performance of the range, in relation to 2010 Building Regulations, has been independently ratified by one of the UK's leading thermodynamics experts.

Building Regulations demand:
 ≤ 0.04 W/(m.K) thermal conductivity at 25mm insulation thickness.

Minimum thermal resistance or R-value = $0.025/0.04 = 0.625$ K/W.

Domus Thermal provides:
 ≤ 0.03 W/(m.K) thermal conductivity at 20mm insulation thickness.

Minimum thermal resistance or R-value = $0.020/0.03 = 0.666$ K/W

The increased thermal resistance of Domus Thermal therefore exceeds current Building Regulations.

Installation

Currently, compliant solutions are more labour intensive and require higher skill levels to install. Domus Thermal's simple interlocking feature means that the system is quicker and easier to install. This revolutionary method can therefore significantly reduce installation costs.

Breadth of range

Domus Thermal is available in a range of profiles and fittings to insulate the Domus EasiPipe (round) and Supertube (rectangular) duct systems.

To support the system, PVC coated, perforated steel banding is also available for surface mounting or suspending the insulated system. The use of this soft-edged fixing system is strongly recommended to ensure that the insulated duct is held securely without damage.

Unique aesthetic design

The interlocking feature and regular external profile provides homeowners with a neat, professional and continuous appearance.

Improved insulation properties

Domus Thermal is manufactured from flame retardant (EN 13163 class E) Silver EPS (expanded polystyrene), which provides its enhanced thermal insulation properties and enables the system to exceed the requirements of the current Building Regulations.

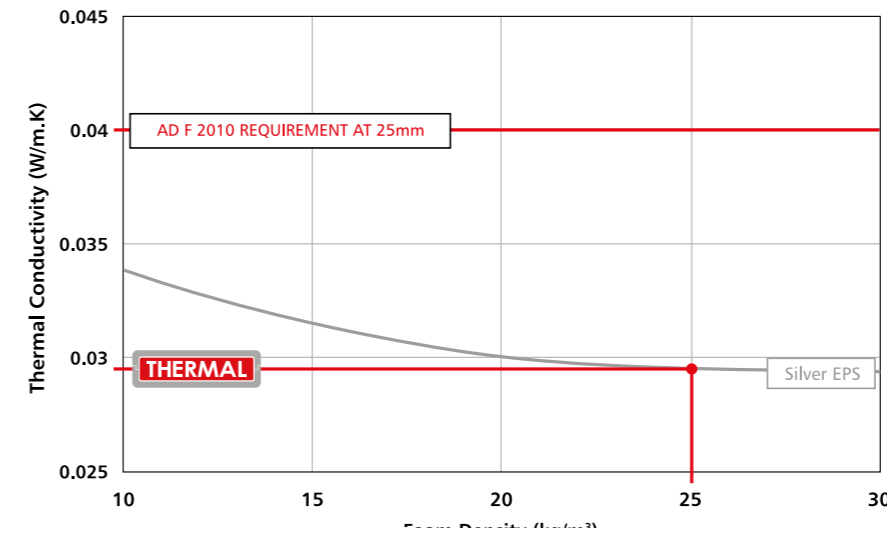

The Silver EPS used to manufacture Domus Thermal provides a significantly improved thermal conductivity value due to the inclusion of carbon particles, which gives Domus Thermal its distinctive silver colour.

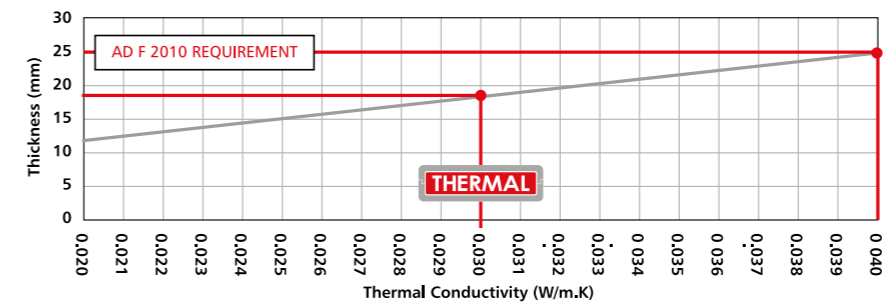

Material

- ▶ Injection moulded, carbon impregnated Expanded Polystyrene (EPS)
- ▶ Density = 25kg/m^3
- ▶ Colour: Silver/Grey

Size

- ▶ Wall thickness 20mm and 22.25mm*
- ▶ Components to suit 100mm internal diameter Domus EasiPipe system
- ▶ Components to suit 125mm internal diameter Domus EasiPipe system
- ▶ Components to suit 150mm internal diameter Domus EasiPipe system
- ▶ Components to suit 204mm x 60mm Domus Supertube system

*22.25mm wall thickness only applies to 1m lengths of 204mm x 60mm

Sustainability

Domus Thermal products are recyclable and when installed in accordance with Domus Ventilation's installation guidelines, Domus Thermal offers a life expectancy greater than or equal to that of the Domus duct system.

Fire resistance

Flame retardant to Class E of EN13163

Accessories

TS22 (coated) and TS22G (not coated)

We offer a choice of coated or uncoated steel banding to support Domus Thermal. Suitable for surface mounting or suspending the insulated system

The Domus Thermal range



Domus Thermal is available in a range of profiles and fittings to insulate the Domus EasiPipe (round) and Supertube (rectangular) duct systems.

To support the system, PVC coated, perforated steel banding is also available for surface mounting or suspending the insulated system. The use of this soft-edged fixing system is strongly recommended to ensure that the insulated duct is held securely without damage.

Round

Product	Code	Description
	TS1100-4	Ø100mm Round Pipe Duct Insulation 1m
	TS1100-5	Ø125mm Round Pipe Duct Insulation 1m
	TS1100-6	Ø150mm Round Pipe Duct Insulation 1m
	TS490	Ø100mm Round 90° Bend Duct Insulation
	TS590	Ø125mm Round 90° Bend Duct Insulation
	TS690	Ø150mm Round 90° Bend Duct Insulation
	TS491	Ø100mm Round 45° Bend Duct Insulation
	TS591	Ø125mm Round 45° Bend Duct Insulation
	TS691	Ø150mm Round 45° Bend Duct Insulation
	TS492	Ø100mm Round Equal T Piece Duct Insulation
	TS592	Ø125mm Round Equal T Piece Duct Insulation
	TS692	Ø150mm Round Equal T Piece Duct Insulation

Rectangular

Product	Code	Description
	TS510	204 X 60mm Channel Duct Insulation 1m
	TS910	220 X 90mm Channel Duct Insulation 1m
	TS550	204 X 60mm Horizontal 90° Duct Insulation
	TS950	220 X 90mm Horizontal 90° Duct Insulation
	TS555	204 X 60mm Horizontal 45° Duct Insulation
	TS955	220 X 90mm Horizontal 45° Duct Insulation
	TS582	204 X 60mm Horizontal T Piece Duct Insulation
	TS982	220 X 90mm Horizontal T Piece Duct Insulation
	TS575	204 X 60mm Vertical 45° Bend Duct Insulation
	TS975	220 X 90mm Vertical 45° Bend Duct Insulation
	TS540	204 X 60mm Fixed Spigot Ø125mm Plenum Duct Insulation
	TS961	220 X 90mm Fixed Spigot Ø125mm Plenum Duct Insulation

► Fire Solutions

Domus Ventilation fire solutions prevent the spread of fire where rigid ducting penetrates fire compartment walls. The range includes horizontal and vertical sleeves.

All Domus Ventilation plastic ductwork is compliant with Domestic Plastic Ductwork Specification DW-154 and will meet UL94VO (duct) and UL94HB (fittings) flammability standard. Operating temperatures of -15°C to 60°C

Regulations

Building Regulations require all services passing through fire compartment walls. Domus Ventilation Fire Sleeves therefore allow plastic duct to meet the requirements of Building Regulations.



Firesleeves – Horizontal

Key features

- ▶ Rectangular profiles tested to BSEN 1366-3: 2009
- ▶ Round profile tested to the temperature and pressure conditions of BSEN 1363-1: 1999 and the principles of BSEN 1366-3: 2009
- ▶ Up to 90 minutes fire rating (see table below for exact rating)
- ▶ Tested with Uncapped/Uncapped (U/U) duct configurations as required for ventilation duct
- ▶ Rectangular profiles are very slimline, saving ceiling space
- ▶ Suitable for masonry walls or plasterboard partitions
- ▶ Suitable for insulated and non-insulated partitions
- ▶ Can be retrofitted
- ▶ No mechanical fixings required
- ▶ Robust galvanised steel shell
- ▶ Performance unaffected by weathering (type x durability)



Product code	Duct size	Space needed around duct to fit the fire collar	Recommended aperture	Length	Fire rating (mins)
DFS110	110 x 54mm	5mm	180 x 73 mm	140mm	120
DFS204	204 x 60mm	5mm	216 x 72mm	140mm	90
DFS220	220 x 90mm	5mm	241 x 112mm	140mm	60



Product code	Duct size	Space needed around duct to fit the fire collar	Recommended aperture	Length	Fire rating (mins)
DFS100	Ø100mm	10mm	130mm	100mm	120
DFS125	Ø125mm	20mm	170mm	180mm	90

Fire Collars – Vertical



Key features

- ▶ Tested to BSEN 1366-3: 2009
- ▶ CE Marked
- ▶ Up to 4 hour fire rating
- ▶ Suitable for PVC, PVC-U, PE, HDPE, MDPE, PP & ABS pipes
- ▶ Available for Ø100mm, Ø125mm and Ø150mm ducting
- ▶ Can be retrofitted
- ▶ Robust galvanised steel shell
- ▶ Performance unaffected by weathering (type X durability)

Product code	Duct size	Space needed around duct to fit the fire collar	Recommended aperture	Length	Fire rating (mins)
DFSV100	Ø100mm	40mm	Ø112mm	50mm	240
DFSV125	Ø125mm	45mm	Ø132mm	50mm	240
DFSV150	Ø150mm	50mm	Ø162mm	50mm	60

FireBrake + Sleeves

Key features

- ▶ 120 minutes fire rated
- ▶ CE marked
- ▶ Can be retrofitted
- ▶ Maintains the integrity of the duct system
- ▶ Quick and simple to install



Independently Third Party Assessed:

30 Minute Partitions:

- ▶ Single board from 72mm upwards

60 Minute Partitions

- ▶ Single and double board systems
- ▶ Single layer ablative coated fire batt

120 Minute Partitions

- ▶ Double board systems
- ▶ Double layer ablative coated fire batt

Multiple Duct Penetrations

- ▶ Up to 3No. side by side ducts*
- ▶ Up to 2No. stacked ducts*
- ▶ Mixed sizes

Product code	Duct size	Nominal thickness	Nominal external width/diameter	Nominal external height	Length	Fire rating (mins)
FBS20460H	204x60mm	10-15mm	228mm	89mm	180mm	120
FBS22090H	220x90mm	10-15mm	244mm	124mm	180mm	120



Product code	Duct size	Nominal thickness	Nominal external width/diameter	Nominal external height	Length	Fire rating (mins)
FBS100H	Ø100mm	15mm	134mm	-	180mm	120
FBS125H	Ø125mm	15mm	160mm	-	280mm	120
FBS150H	Ø150mm	20mm	200mm	-	280mm	120

Fire Rated Ceiling Air Valves



Product overview

Recessed ceiling air valves are widely used in both domestic and commercial buildings. Ceilings must be fire protected in accordance with Approved Document B of the Building Regulations.

Once a hole is made in a ceiling for an air valve, the integrity of the construction and its ability to perform in a fire is reduced significantly. This must be fire-stopped to reinstate the original fire rating of the ceiling.

The popularity of whole-house ventilation and controlled ventilation is increasing. This results in an increased number of penetrations through fire compartment walls and floors producing open pathways for the passage of both smoke and fire.

Ceiling air valves, if left unprotected, can allow a fire to spread rapidly through a building.

Fire testing

Successfully tested for 60 minutes according to BS EN 1365-2:1999 & BS 476 Test report number: BTC 18074F

Dimensions

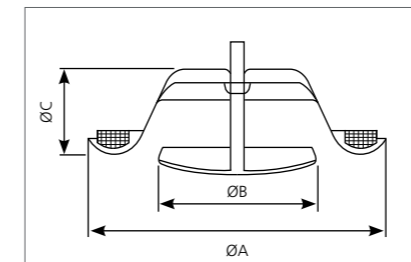

Key features

- ▶ Meet the requirement of Building Regulations Approved Document B
- ▶ Maintains integrity of fire rated ceilings for up to 60 minutes
- ▶ Alternative to more expensive fire dampers
- ▶ Fits in exactly the same way as a standard metal air valve
- ▶ Air flow is unaffected
- ▶ Easy to retrofit in place of existing metal air valves
- ▶ Highly cost effective

Product code	Duct size	A (mm)	B (mm)	C (mm)	Weight (kg)
136FR-24M	Ø100mm	140	75	40	0.16
136FR-25M	Ø125mm	170	99	46	0.23
136FR-26M	Ø150mm	202	119	54	0.34

▶ Grilles and External Grilles

We offer a wide range of stylish architectural grilles for internal and external use.

Where fittings are available in different colours:

Colour	RAL Reference and Title		Colour	RAL Reference and Title	
	White	Traffic White RAL 9016		Terracotta	Copper Brown RAL 8004
	Brown	Nut Brown RAL 8011		Black	Traffic Black RAL 9017
	Cotswold	Ivory RAL 1014		Grey	Telegrey 2 RAL 7049





















External Wall Duct Terminals

110x54mm System					
	Code	Description	Colour	Size (mm)	Connection
	DD077	Rigid Duct In-Line Adapter (Rectangular-Rectangular)	White	H70xW210xD62	Female
	4901W	Rigid Duct Outlet with Gravity Flaps	White	H155xW155xD30	Male
	4901B	Rigid Duct Outlet with Gravity Flaps	Brown	H155xW155xD30	Male
	4901C	Rigid Duct Outlet with Gravity Flaps	Cotswold	H155xW155xD30	Male
	4901T	Rigid Duct Outlet with Gravity Flaps	Terracotta	H155xW155xD30	Male
	4903W	Rigid Duct Outlet Cowled with Damper	White	H155xW155xD100	Male
	4903B	Rigid Duct Outlet Cowled with Damper	Brown	H155xW155xD100	Male
	4905W	Rigid Duct Outlet Louvered Grille	White	H155xW155xD40	Male
	4905B	Rigid Duct Outlet Louvered Grille	Brown	H155xW155xD40	Male
	4905C	Rigid Duct Outlet Louvered Grille	Cotswold	H155xW155xD40	Male
	4905T	Rigid Duct Outlet Louvered Grille	Terracotta	H155xW155xD40	Male
	F4905W	Rigid Duct Outlet Louvered Grille with Flyscreen	White	H155xW155xD40	Male
	F4905B	Rigid Duct Outlet Louvered Grille with Flyscreen	Brown	H155xW155xD40	Male
	F4905C	Rigid Duct Outlet Louvered Grille with Flyscreen	Cotswold	H155xW155xD40	Male







204x60mm System					
	Code	Description	Colour	Size (mm)	Connection
	505W	Rigid Duct Outlet Airbrick	White	H70xW210xD62	Female
	505B	Rigid Duct Outlet Airbrick	Brown	H70xW210xD62	Female
	505C	Rigid Duct Outlet Airbrick	Cotswold	H70xW210xD62	Female
	505T	Rigid Duct Outlet Airbrick	Terracotta	H70xW210xD62	Female
	505BK	Rigid Duct Outlet Airbrick	Black	H70xW210xD62	Female
	505G	Rigid Duct Outlet Airbrick	Grey	H70xW210xD62	Female
	501W	Rigid Duct Outlet Airbrick with Damper	White	H69xW210xD56	Male
	501B	Rigid Duct Outlet Airbrick with Damper	Brown	H69xW210xD56	Male
	501C	Rigid Duct Outlet Airbrick with Damper	Cotswold	H69xW210xD56	Male
	501T	Rigid Duct Outlet Airbrick with Damper	Terracotta	H69xW210xD56	Male
	55015W	Rigid Duct Outlet Airbrick with Damper and Wall Plate	White	H69xW210xD56	Male
	55015B	Rigid Duct Outlet Airbrick with Damper and Wall Plate	Brown	H69xW210xD56	Male
	957	Rigid Duct In-Line Adapter (Rectangular-Rectangular)	White	204x60-220x90	Male/Female

220x90mm System					
	Code	Description	Colour	Size (mm)	Connection
	977	Rigid Duct In-Line Adapter Rectangular-Rectangular	White	H133xW227xD52	Female/Male
	905W	Rigid Duct Outlet Airbrick Double	White	H140xW250xD75	Female
	905B	Rigid Duct Outlet Airbrick Double	Brown	H140xW250xD75	Female
	905C	Rigid Duct Outlet Airbrick Double	Cotswold	H140xW250xD75	Female
	905T	Rigid Duct Outlet Airbrick Double	Terracotta	H140xW250xD75	Female
	905BK	Rigid Duct Outlet Airbrick Double	Black	H140xW250xD75	Female
	905G	Rigid Duct Outlet Airbrick Double	Grey	H140xW250xD75	Female













Ø100mm System

	Code	Description	Colour	Size (mm)	Connection
	4900W	Rigid Duct Outlet with Gravity Flaps	White	H155xW155xD30	Male
	4900B	Rigid Duct Outlet with Gravity Flaps	Brown	H155xW155xD30	Male
	4900C	Rigid Duct Outlet with Gravity Flaps	Cotswold	H155xW155xD30	Male
	4900T	Rigid Duct Outlet with Gravity Flaps	Terracotta	H155xW155xD30	Male
	4900BK	Rigid Duct Outlet with Gravity Flaps	Black	H155xW155xD30	Male
	4902W	Rigid Duct Outlet Cowled with Damper	White	H155xW155xD100	Male
	4902B	Rigid Duct Outlet Cowled with Damper	Brown	H155xW155xD100	Male
	4902C	Rigid Duct Outlet Cowled with Damper	Cotswold	H155xW155xD100	Male
	4902T	Rigid Duct Outlet Cowled with Damper	Terracotta	H155xW155xD100	Male
	4902BK	Rigid Duct Outlet Cowled with Damper	Black	H155xW155xD100	Male
	4904W	Rigid Duct Outlet Louvered Grille	White	H155xW155xD45	Male
	4904B	Rigid Duct Outlet Louvered Grille	Brown	H155xW155xD45	Male
	4904C	Rigid Duct Outlet Louvered Grille	Cotswold	H155xW155xD45	Male
	4904T	Rigid Duct Outlet Louvered Grille	Terracotta	H155xW155xD45	Male
	4904BK	Rigid Duct Outlet Louvered Grille	Black	H155xW155xD45	Male
	F4904W	Rigid Duct Outlet Louvered Grille with Flyscreen	White	H155xW155xD45	Male
	F4904B	Rigid Duct Outlet Louvered Grille with Flyscreen	Brown	H155xW155xD45	Male
	F4904C	Rigid Duct Outlet Louvered Grille with Flyscreen	Cotswold	H155xW155xD45	Male
	F4904T	Rigid Duct Outlet Louvered Grille with Flyscreen	Terracotta	H155xW155xD45	Male

Ø100mm System

	Code	Description	Colour	Size (mm)	Connection
	F4904BK	Rigid Duct Outlet Louvered Grille with Flyscreen	Black	H155xW155xD45	Male
	4804W	Rigid Duct Outlet Louvered Soffit Vent	White	H122xW122xD27	Male
	4804B	Rigid Duct Outlet Louvered Soffit Vent	Brown	H122xW122xD27	Male
	F4804W	Rigid Duct Outlet Louvered Soffit Vent with Flyscreen	White	H122xW122xD27	Male
	F4804B	Rigid Duct Outlet Louvered Soffit Vent with Flyscreen	Brown	H122xW122xD27	Male

Ø125mm System

	Code	Description	Colour	Size (mm)	Connection
	5900W	Rigid Duct Outlet with Gravity Flaps	White	H155xW155xD30	Male
	5900B	Rigid Duct Outlet with Gravity Flaps	Brown	H155xW155xD30	Male
	5900C	Rigid Duct Outlet with Gravity Flaps	Cotswold	H155xW155xD30	Male
	5900T	Rigid Duct Outlet with Gravity Flaps	Terracotta	H155xW155xD30	Male
	5902W	Rigid Duct Outlet Cowled with Damper	White	H155xW155xD100	Male
	5902B	Rigid Duct Outlet Cowled with Damper	Brown	H155xW155xD100	Male
	5902C	Rigid Duct Outlet Cowled with Damper	Cotswold	H155xW155xD100	Male
	5902T	Rigid Duct Outlet Cowled with Damper	Terracotta	H155xW155xD100	Male
	5904W	Rigid Duct Outlet Louvered Grille	White	H155xW155xD45	Male
	5904B	Rigid Duct Outlet Louvered Grille	Brown	H155xW155xD45	Male
	5904C	Rigid Duct Outlet Louvered Grille	Cotswold	H155xW155xD45	Male
	5904T	Rigid Duct Outlet Louvered Grille	Terracotta	H155xW155xD45	Male

Ø125mm System

Code	Description	Colour	Size (mm)	Connection
F5904W	Rigid Duct Outlet Louvered Grille with Flyscreen	White	H155xW155xD45	Male
F5904B	Rigid Duct Outlet Louvered Grille with Flyscreen	Brown	H155xW155xD45	Male
F5904C	Rigid Duct Outlet Louvered Grille with Flyscreen	Cotswold	H155xW155xD45	Male
F5904T	Rigid Duct Outlet Louvered Grille with Flyscreen	Terracotta	H155xW155xD45	Male
F5904BK	Rigid Duct Outlet Louvered Grille with Flyscreen	Black	H155xW155xD45	Male

Ø150mm System

Code	Description	Colour	Size (mm)	Connection
6900W	Rigid Duct Outlet with Gravity Flaps	White	H155xW155xD30	Male
6900B	Rigid Duct Outlet with Gravity Flaps	Brown	H155xW155xD30	Male
6900C	Rigid Duct Outlet with Gravity Flaps	Cotswold	H155xW155xD30	Male
6900T	Rigid Duct Outlet with Gravity Flaps	Terracotta	H155xW155xD30	Male
6902W	Rigid Duct Outlet Cowled with Damper	White	H155xW155xD100	Male
6902B	Rigid Duct Outlet Cowled with Damper	Brown	H155xW155xD100	Male
6902C	Rigid Duct Outlet Cowled with Damper	Cotswold	H155xW155xD100	Male
6902T	Rigid Duct Outlet Cowled with Damper	Terracotta	H155xW155xD100	Male
6904W	Rigid Duct Outlet Louvered Grille	White	H155xW155xD45	Male
6904B	Rigid Duct Outlet Louvered Grille	Brown	H155xW155xD45	Male
6904C	Rigid Duct Outlet Louvered Grille	Cotswold	H155xW155xD45	Male
6904T	Rigid Duct Outlet Louvered Grille	Terracotta	H155xW155xD45	Male

Ø150mm System

Code	Description	Colour	Size (mm)	Connection
F6904W	Rigid Duct Outlet Louvered Grille with Flyscreen	White	H155xW155xD45	Male
F6904B	Rigid Duct Outlet Louvered Grille with Flyscreen	Brown	H155xW155xD45	Male
F6904C	Rigid Duct Outlet Louvered Grille with Flyscreen	Cotswold	H155xW155xD45	Male
F6904T	Rigid Duct Outlet Louvered Grille with Flyscreen	Terracotta	H155xW155xD45	Male
F6904BK	Rigid Duct Outlet Louvered Grille with Flyscreen	Black	H155xW155xD45	Male

External Roof Duct Terminals



Also available in Terracotta

Design and performance

The Universal Service Terminal is suitable for use in all tiled and slated pitched roof styles without the need to identify the make or design of the tiles or slates. The unit comprises a flat box hood on a circular upstand, a 500mm x 500mm flashing skirt of non-lead material and a stepped adaptor that allows connection to 100mm, 110mm, 125mm, 150mm and 160mm ventilation pipe. This unit can also be used to vent soil and vent pipes where an external pressure test is not required.

The free areas and pressure/airflow readings are as follows:

Diameter (mm)	Free vent area (mm ²)	Pressure/Airflow Resistance (pa)	
		100m ³ /hr	200m ³ /hr
100	7,850	3.0	7.5
110	8,850	4.5	16.0
125	12,250	5.3	24.0
150	17,775	6.5	31.0
160	18,750	6.5	31.0

The unit is easy to install – the adaptor is simply cut at the required diameter step and attached to the undertile spigot with solvent weld/PVC glue. The flashing material allows fitting into most tiles and slates.

Code	Colour	Connection
4411	Black	Male
4411T	Terracotta	Male

Key features and benefits

- ▶ Large diameter spigot c/w Adaptor to accept ducting of 100/110/125/150/160mm
- ▶ 20,000mm² large free vent area

Roof finish









- ▶ Suitable for most tiled and slated pitched roofs
- ▶ **Not suitable for flat roof application**





Material





- ▶ Flashing skirt manufactured from non-lead material
- ▶ Terminal, Box and Adaptor manufactured from UPVC and Ubiflex

Internal Duct Terminals

Ø100mm System					
	Code	Description	Colour	Size (mm)	Connection
	136-04	Air Valve Extract or Supply	White	H147xW147xD43	Male
	136-24	Air Valve Extract or Supply Suspended Ceiling	White	H147xW147xD75	Male
	136FR-24M	Air Valve Extract or Supply Suspended Ceiling (Fire Rated)	White	H200xW200xD88	Male
	4908F	Multi-Directional Diffuser with Filter	White	H154xW154xD64	Male
	40AF	Environmental Filter Spare Part	Grey	N/A	N/A
	40AFP	Pollen Filter Spare Part	Grey	N/A	N/A
	4907W	Rigid Duct Diffuser	White	H140xW140xD70	Male
	4907CH	Rigid Duct Diffuser	Chrome	H140xW140xD70	Male

Ø125mm System					
	Code	Description	Colour	Size (mm)	Connection
	136-05	Air Valve Extract or Supply	White	H165xW165xD40	Male
	136-25	Air Valve Extract or Supply Suspended Ceiling	White	Hx165W165xD78	Male
	136FR-25M	Air Valve Extract or Supply Suspended Ceiling (Fire Rated)	White	H166xW166xD58	Male
	5907W	Rigid Duct Diffuser	White	H165xW165xD71	Male
	ART125-CF1S	Architectural Room Terminal Curved	Silver	H202xW208xD100	N/A
	ART125-CF1BM	Architectural Room Terminal Curved	Brushed Metal	H202xW208xD100	N/A
	ART125-CF1W	Architectural Room Terminal Curved	White	H202xW208xD100	N/A
	ART125-DT15	Architectural Room Terminal Circular Indent	Silver	H200xW200xD88	N/A

Ø125mm System					
	Code	Description	Colour	Size (mm)	Connection
	ART125-DT1W	Architectural Room Terminal Circular Indent	White	H200xW200xD88	N/A
	ART125-SD2W	Architectural Diffuser Wave	White	H188xW188xD30	N/A
	ART125-SD1W	Architectural Diffuser	White	H188xW188xD30	N/A
	ART125-CD1W	Architectural Circular Diffuser	White	H176xW176xD68	N/A

Ø150mm System					
	Code	Description	Colour	Size (mm)	Connection
	136-06	Air Valve Extract or Supply	White	H183xW183xD40	Male
	136-26	Air Valve Extract or Supply Suspended Ceiling	White	H199xW199xD76.5	Male
	136FR-26M	Air Valve Extract or Supply Suspended Ceiling (Fire Rated)	White	H199W199D58	Male
	6907W	Rigid Duct Diffuser	White	H186xW186xD70	Male

Spotvent LED Ceiling Grille					
	Code	Description	Colour	Size (mm)	Connection
	SPV801TWCG	Spotvent Ceiling LED Light Grille Spare Part	N/A	N/A	N/A

► Attenuation



Our Rigid Duct Attenuators offer excellent sound absorption over a range of audible frequencies.

Our rigid duct sound attenuator range now includes variants with even better sound attenuation performance, at the levels which count – the frequency in which room-to-room cross talk and appliance noise are more prominent to our hearing!

Code	Size
5SL-500	204x60mm
9SL-500	220x90mm

Key features & benefits

- ▶ Best performing plastic attenuation on the market
- ▶ Excellent sound attenuation properties as verified by the Sound Research Laboratories (SRL)
- ▶ Tamper proof
- ▶ Significantly reduces transmitted appliance noise and room-to-room cross talk
- ▶ Protected foam helps enable a long life, clean and fresh ventilation system
- ▶ Low profile increases installation options and offers greater flexibility
- ▶ Lightweight and easy to fit for quicker installation time
- ▶ Can also be used with Domus Thermal duct insulation
- ▶ Helps facilitate occupant acceptance of a continuously running centralised ventilation system
- ▶ Helps achieve Building Regulation recommendations
- ▶ The installation of Domus Ventilation rigid duct attenuators over metal alternatives, provides peace of mind that future replacement due to corrosion won't occur

Why use sound attenuators?

- ▶ Noise generated by a mechanical extract appliance could result in occupants incorrectly altering the performance of their system and as a consequence, detrimentally impacting indoor air quality.
- ▶ To avoid this, Building Regulations stipulate that the system should not produce excessive noise that could discourage occupants from using it correctly.
- ▶ In addition to this, resident cross talk carried through connecting room-to-room ducting can also impair homeowner comfort.

Range

To support the most popular rectangular rigid duct profiles our attenuators are available to install with 204x60mm and 220x90mm duct systems.

The attenuator can bolt together with connector **520** or **920** to increase length.



Materials

Duct attenuator: PVC plastic ducting
Acoustic Foam Material: High Density Reconstituted PVC/Nitrile Foam with a density of 240kg/m³. Foam contains a unique uniform cell structure, offering excellent sound absorption properties, particularly at low frequency.

Flame Retardant, compliant to BS476 Part 7 Class 1, UL94-HF1, UL94-V0 (tested by Warrington Bodycote) and FMVSS 302.

Regulations

Approved Document F of the Building Regulations F1 Means of Ventilation recommends that the system should not produce excessive noise that could discourage occupants from using it correctly.

A rigid duct attenuator should therefore form part of duct system, to ensure occupants do not incorrectly alter the performance of the system and as a consequence, detrimentally impact indoor air quality.



Sound Absorption Chart

Code	Size (mm)	125Hz	250Hz	500Hz	1000Hz	2000Hz	4000Hz	8000Hz
5SL-500	204x60	0.2	4.2	7.4	19	19.3	21.6	22.2
9SL-500	220x90	2.9	3.5	12.3	15.5	17	18.1	18.8

Acoustic sound results

5SL-500

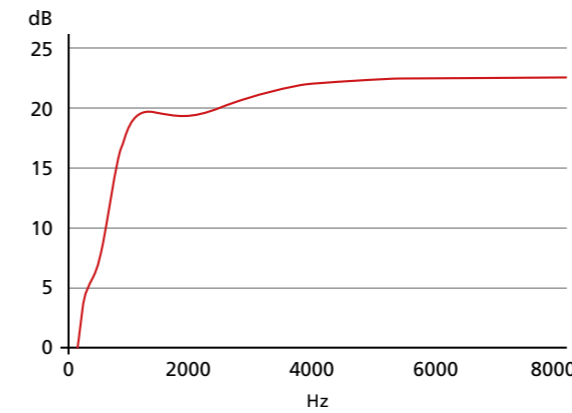

9SL-500

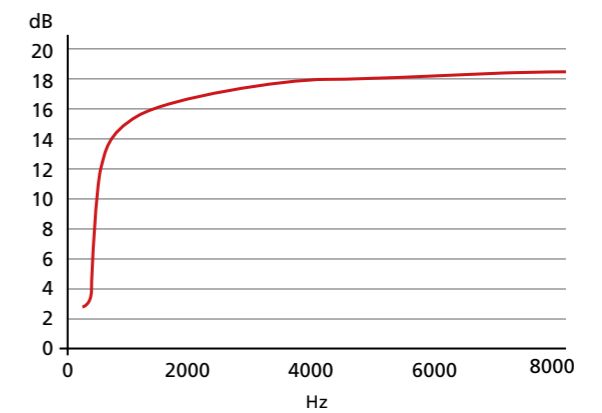

Cumulative length acoustic sound results

Octave Band Insertion Loss – 5SL-500

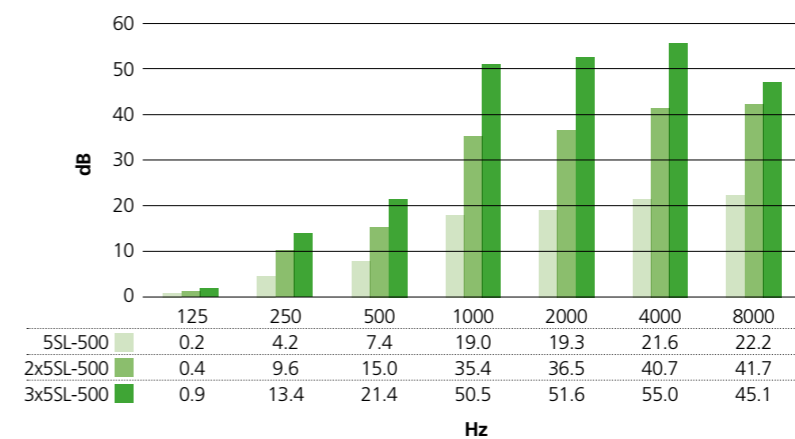

Octave Band Insertion Loss – 9SL-500

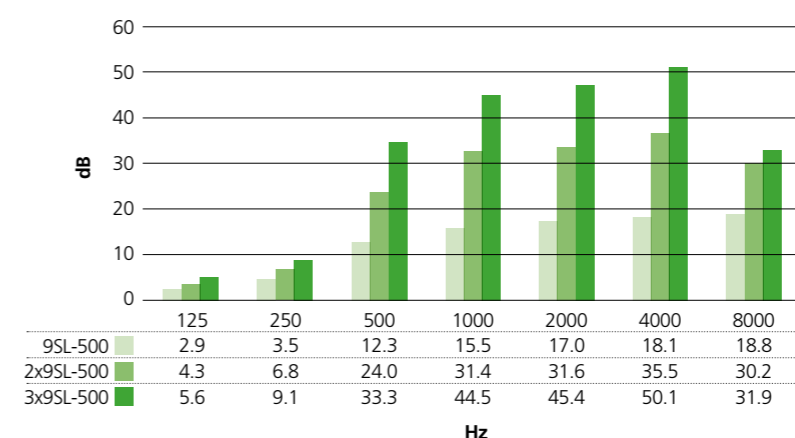

The diagrams illustrate the increased sound absorption levels when close-coupling up to three individual 0.5m lengths of rigid duct attenuators, thus reducing noise levels by up to 55dB.



Domus Ventilation
Cambria House
Caerphilly Business Park
Van Road
Caerphilly
CF83 3ED

UK tel: 03443 715523
Email: vent.sales@domusventilation.co.uk
Web: www.domusventilation.co.uk

Domus Ventilation reserve the right to alter and or
remove/add information at the company's discretion.

January 2020