



Evolve Q50i Queuing System

Retail Shelving Solutions

EVOLVE Q50i

EVOLVE Q50i



We are proud to announce the addition of this exciting Q-System range to our Evolve Collection of products.

“

The contemporary design features guarantee it will be an attractive addition to any store either as a Q-Management system or simply as a very compact narrow low level gondola.

”

Evolve Q50i is a unique point of sale range which offers exceptional value for money. It has been expertly designed to the highest possible standard, providing unparalleled flexibility & ease of installation. It takes minutes to install!

The comprehensive range provides a multitude of merchandising opportunities for Q-Management displays in any environment.

The Evolve Q50i Collection has been independently designed on the generic 50mm pitch system and provides you with a top quality range of retail fittings.

The Collection gives you the ultimate in choice, flexibility and quality. The best part is, our prices are the most competitive in the market.

The aim is simple, to provide customers with the most flexible and comprehensive shelving service

available on the market along with unquestionable friendly, first class customer service and support.

We offer next day delivery, despatched directly from our warehouse.

The Q-System range is completely compatible with the main EVOLVE S50i Collection (more details can be found on pages 17-26).



The system is available in a range of upright & base plate colours to suit your requirements, Silver RAL 9006 being the standard base colour. As with all components within the EVOLVE range, the superior manufacture and finish means you can rest assured it is going to be durable and stand the test of time.

The gauge of material is of a superior thickness, this certifies the system is particularly strong and reliable. The 450mm round base plates are specifically designed concave to provide maximum stability using 5mm thick steel.

What are the benefits?

- ▶ Unique shelves - the rear of the shelf 'wraps' the 60mm round upright therefore leaving a seamless run for optimal display. No gaps at the rear of the shelves, no gaps between uprights.
- ▶ Uniquely designed removable tie bar for hooks & hanging displays. This removable tie bar can be simply removed mid-run without the need to dismantle adjacent bays
- ▶ 8 way post if required for multi angles - 45, 90 & 135 degrees
- ▶ Half spherical PETG display bowls for the top of uprights. This includes a unique damper system to save breakages
- ▶ Snap back tensator for Open/Closed Q-Management positions
- ▶ A4 Click-In signage posts. This can be either portrait or landscape



Accessories for the Q-System Range include:

- ▶ PETG Newspaper/Magazine & Card Racks
- ▶ Hooks & Hanging displays
- ▶ Merchandising bins for loose items such as sweets and crisps
- ▶ Oval Rear Support Bars & Accessories
- ▶ Acrylic, Plastic & Wire Riser & Divider Shelf Management systems
- ▶ Full range of coloured scanning ticket mouldings



A Typical Run of Q-System Bays



Component breakdown of single sided starter bay



This drawing is designed to illustrate the various components which are required in the construction of a single sided starter bay.

Component breakdown of double sided starter bay

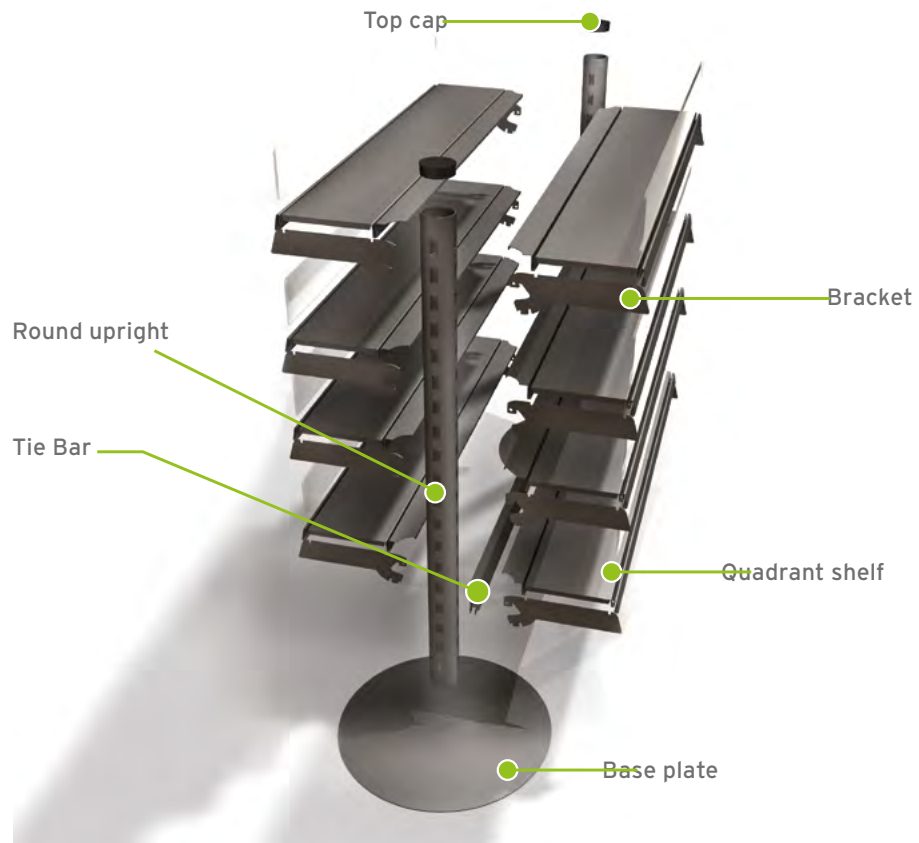

Single starter bay with dimensions



This drawing is designed to illustrate the various components which are required in the construction of a double sided starter bay.

Standard Bay & Shelves

A single bay with shelves is ideal to display multiple merchandising options.



Benefits:

- ▶ Strong and versatile
- ▶ Quick to assemble
- ▶ Hygienic

Dimensions:

- ▶ 1010mm x 665mm, 1000mm and 1250mm

Standard Bay & Newspaper Shelves

A standard bay with PETG newspaper shelves is the perfect solution for tidily displaying larger printed items in volume. Easy to install and manufactured from high quality PETG material for maximum product visibility.



Benefits:

- ▶ A perfect partner to go with the PETG magazine shelves.
- ▶ Clear PETG material which is strong, flexible and maximises product image

Dimensions:

- ▶ 1010mm x 1000mm and 1250mm

Standard Bay & Hooks

A hook system is specifically designed for the Q-System to provide an ideal solution for all items requiring a hanging display.



Benefits:

- ▶ A flexible system structured around removable Tie Bars enabling displays to be easily reconfigured as required

Dimensions:

- ▶ 1010mm x 665mm, 1000mm and 1250mm

Standard Bay & Magazine

The tiered magazine bay is designed to merchandise magazines in high volume whilst maintaining a professional finish. Manufactured in a strong PETG material offering clear product visibility for maximum impact.



Benefits:

- ▶ A perfect partner to go with the PETG newspaper shelves.
- ▶ Clear, strong PETG material, 1,2,3 tiered displays available for maximum flexibility in merchandising

Dimensions:

- ▶ 1010mm x 665mm, 1000mm and 1250mm

Standard Bay & Crisp / Merchandising Bins

A tidy, convenient method to display bagged items such as crisps and snack goods. Brilliant for high impact impulse sales



Benefits:

- ▶ Clear PETG material. Strong product impact and visibility



Flexibility in composition.
Images show the 90° angle and the 45° angle

Starter Bay

Bays are simple to construct:

- ▶ Begin with a starter bay then simply add as many follow on bays as you like.
- ▶ Next, all you have to do is decide how you would like to dress your Q-System display stands: PETG, Hooks, Shelves etc.



Follow on Bay





Special colours available
Contact us for a quotation



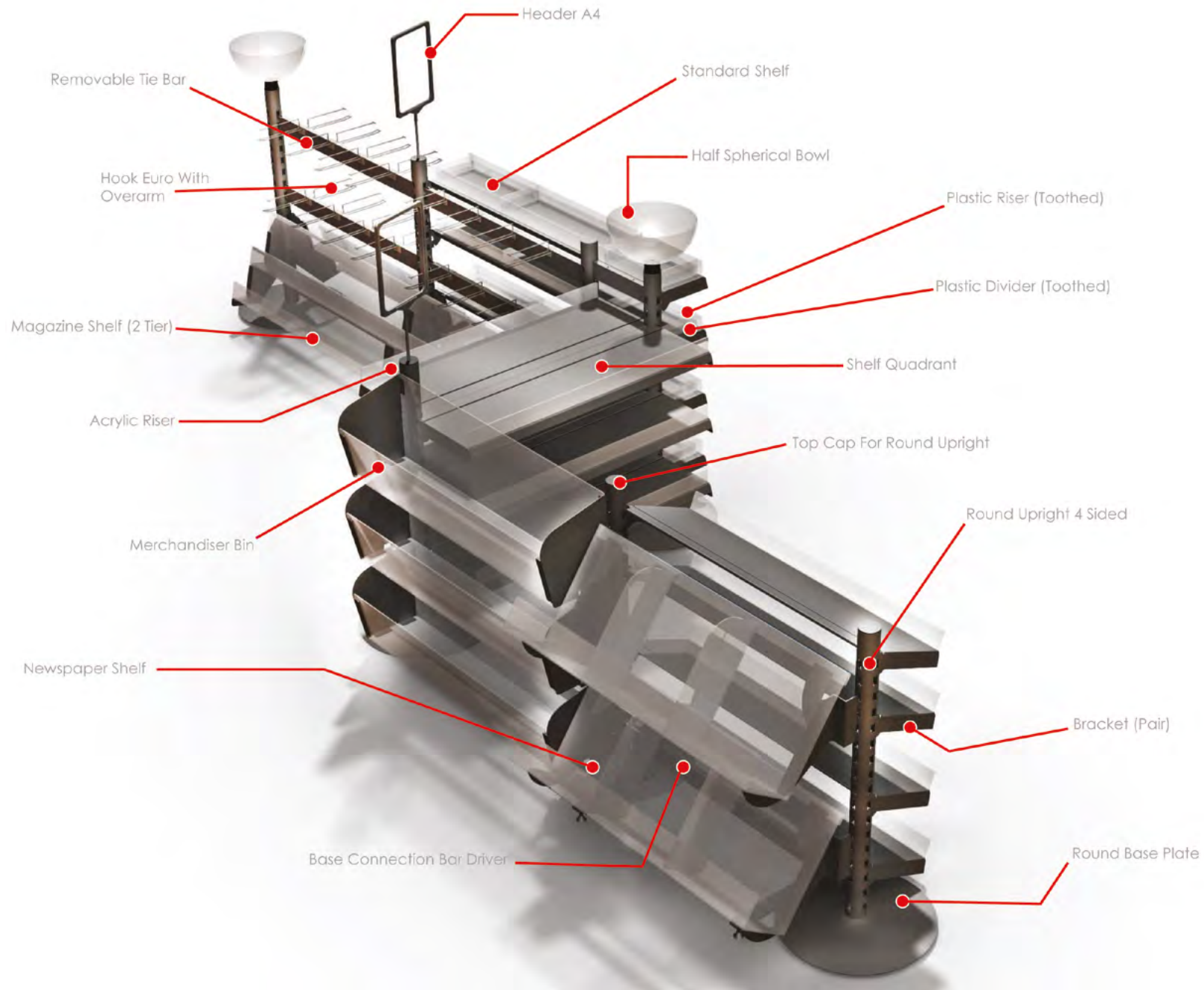

Round Uprights (4 sided)

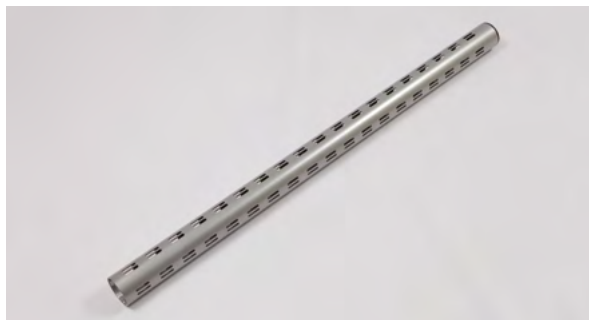

SIZE (MM)	FINISH
1000 x 60	Silver

The 60mm 4 sided round upright is designed to create both straight as well as 90 degree display runs. To be used with the round base plate and fixing bolt.

Round Uprights (8 sided)



SIZE (MM)	FINISH
1000 x 60	Silver

The 60mm 8 sided round upright is designed to create straight, 45 degree as well as 90 degree display runs. To be used with the round base plate and fixing bolt.

Round Base Plates

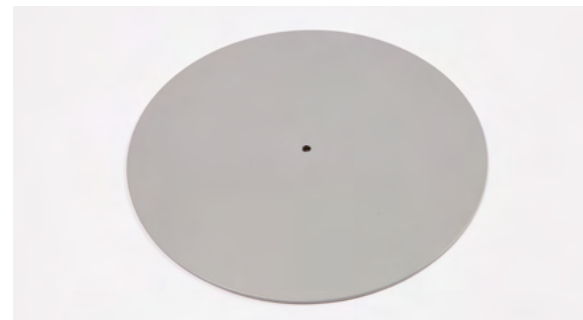

SIZE (MM)	FINISH
450	Silver

The 5mm thick round base plate provides the optimum floor fixture for the display unit. Slightly convex in design, adds style but also gives the assurance for a non trip hazard base section.

Base Connection Bar Driver



SIZE (MM)	FINISH
275	Silver
665	Silver
1000	Silver
1250	Silver

A very strong tie bar designed to brace the display unit. Only 1 required per unit. Alternatively the removable tie bar can also be used if preferred.

Removable Tie Bar



SIZE (MM)	FINISH
665	Silver
1000	Silver
1250	Silver

The removable tie bar is designed to allow easy flexibility around merchandising. The bar is unique in the fact that it can be removed and then relocated without having to dismantle any of the structural display. Use this tie bar with hooks to create versatile hanging displays.

Fixing Bolt & Washer for Round Base Plates



SIZE (MM)	FINISH
M10	Zinc

The fixing bolt is required to connect the round upright and round base plate together securely.

Brackets (pair)

SIZE (MM)	FINISH
200	Silver

Supplied in pairs, shelf brackets hook into the uprights providing a secure support for shelves. The brackets are adjustable to angles of 20 degrees and 35 degrees.



Our shelving system is based on a 50mm pitch which has become the benchmark for much of the retail industry.

Standard Shelf (brackets not included)

SIZE (MM)	FINISH
200 x 665	Silver
200 x 1000	Silver
200 x 1250	Silver

Standard shelves provide a solid one piece display surface.

Quadrant Shelf (brackets not included)

SIZE (MM)	FINISH
200 x 665	Silver
200 x 1000	Silver
200 x 1250	Silver

Quadrant shelf with infill to securely fit the rear of the shelf. "Wraps" the round upright leaving no gaps between shelves (rear & side). Creates a seamless run.

Shelving options

Metal and PETG solutions to suit your needs.

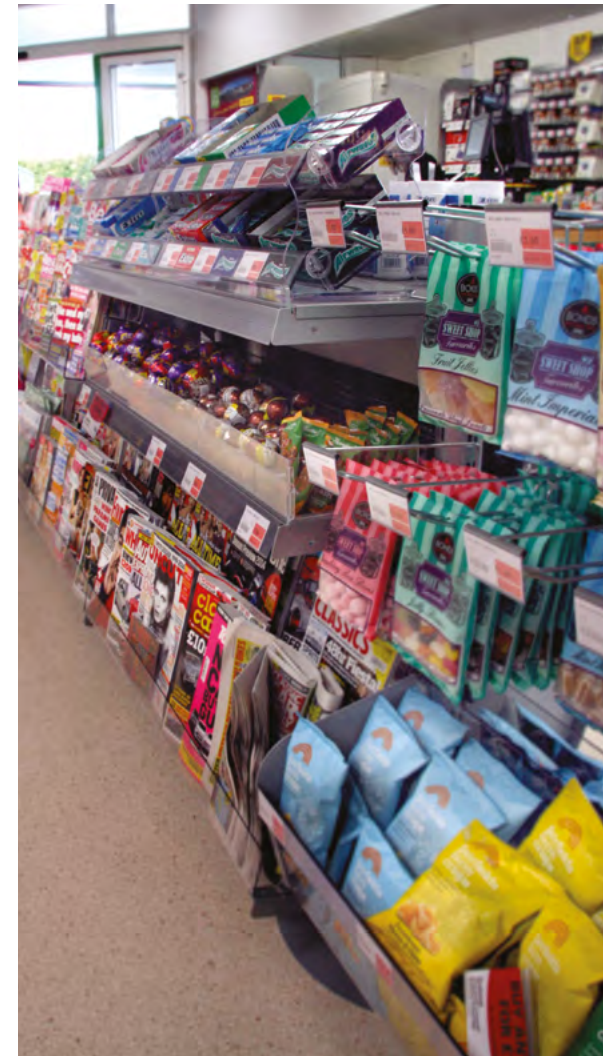

PETG Tiered Magazine Shelf



SIZE (MM)	FINISH	FINISH
1 Tier	70	665
1 Tier	70	1000
1 Tier	70	1250
2 Tier	70	665
2 Tier	70	1000
2 Tier	70	1250
3 Tier	70	665
3 Tier	70	1000
3 Tier	70	1250

Supplied in 1, 2 & 3 tier options complete with brackets. Our magazine shelf is designed to display magazines in a tiered formation and is manufactured in a clear PETG material. This allows the full length of the magazine to be displayed at the front of each tier whilst offering great strength and flexibility.

PETG Merchandise Bin



SIZE (MM)	FINISH
665	Clear
1000	Clear
1250	Clear

A perfect way to display small, loose items in a manner which makes products visual and easily accessible. The bin slots securely into the upright and can be fitted in seconds. Supplied complete with brackets.

PETG Newspaper Shelf



SIZE (MM)	FINISH
1000	Clear
1250	Clear

This newspaper shelf allows newspapers to be displayed in maximum volume. The shelves are produced in a clear PETG material making them strong and flexible as well as easy to assemble. Supplied complete with brackets.

Half Spherical Bowl



SIZE (MM)	FINISH
350	Clear

A high quality PETG manufactured clear bowl designed to sit on top of the round upright for impulse display. Supplied complete with a rubber mount for flexible movement eliminating cracks and breakages - best on the market.



Top Cap for Round Upright



SIZE (MM)	FINISH
60	Black PVC

A plain black PVC plastic top cap designed to plug into the top of the round upright.

Top Cap for Round Upright
complete with M10 threaded nut



SIZE (MM)	FINISH
60	Black PVC

A black PVC plastic top cap with an M10 threaded nut inside. Fits into the top of the round upright to accommodate A4 sign holder and PETG bowl.

Top Cap for Tensator



SIZE (MM)	FINISH
60	Black PVC

A black PVC plastic top cap with an M10 threaded bolt inside fits into the round upright to accommodate the retractable tensator attachment.

Foot Disc



SIZE (MM)	FINISH
95	Zinc

The foot disc is to be used in conjunction with the round upright when creating an internal 90 degree corner utilising the 275mm driver bar.

A4 Header Frame



FINISH
Black

An A4 header frame to locate signage onto the top of a round upright. Use with 'T' piece, upstand and top cap with M10 nut.

Header 'T' piece for A4 Frame



FINISH
Black

The 'T' piece is used in conjunction with the A4 header allowing connection to the chrome upstand.

Header upstand
for A4 Frame 'T' piece



SIZE (MM)	FINISH
160	Chrome

The chrome upstand is to be used with the A4 header and 'T' piece to be connected into the top cap with M10 nut.

Tensator



SIZE (MM)	FINISH
60	Black/Chrome

A high quality tensator with a retractable belt which enables non merchandised partitions to be created.

Plastic Divider (Plain)



SIZE (MM)	FINISH
75 x 200	Clear

The plain plastic divider creates a single sub section that covers the entire depth of the shelf. When using plastic dividers an additional plastic riser is required for the rear groove of the shelf.

Plastic Divider (Toothed)



SIZE (MM)	FINISH
75 x 200	Clear

The toothed plastic divider creates a single sub section that covers the entire depth of the shelf. When using plastic dividers an additional plastic riser is required for the rear groove of the shelf.

Acrylic Divider



SIZE (MM)	FINISH
75 x 200	Clear

Acrylic dividers are supplied in a clear glass effect finish. An acrylic riser is required to the front of the shelf only in order to securely fix an acrylic divider in place.

Acrylic Riser



SIZE (MM)	FINISH
95 x 665	Clear
95 x 1000	Clear
95 x 1250	Clear

Acrylic risers provide the clearest finish of all the risers available whilst also providing fantastic strength. These are 95mm in height leaving 75mm exposed when positioned in the shelf. Manufactured to create a clear glass effect, this product locates into the groove at the front of the shelf.

Plastic Subdivider



SIZE (MM)	FINISH
75 x 84	Clear
75 x 165	Clear

Subdividers are for use with the plastic toothed dividers. This product allows you to divide a shelf's merchandising area to suit your specific product requirement.

Plastic Riser (Toothed)

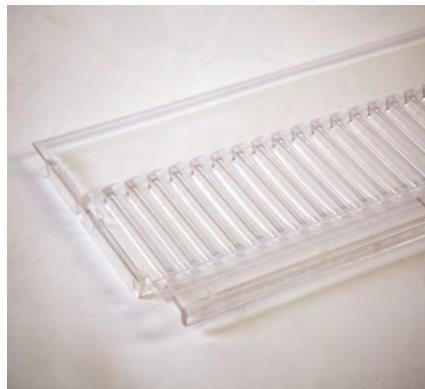

SIZE (MM)	FINISH
95 x 665	Clear
95 x 1000	Clear
95 x 1250	Clear

Plastic toothed risers provide a neat finish to any bay of shelving whilst also being kind to your budget. These plastic risers are 95mm in height leaving 75mm exposed when positioned in the shelf. When using plastic dividers an additional plastic riser is required for the rear groove of the shelf.

Low Front Strip



SIZE (MM)	FINISH
35 x 665	Clear
35 x 1000	Clear
35 x 1250	Clear

Low front strips (PVC) are designed to locate perfectly into the groove at the front of a shelf. Low front strips are 35mm in height leaving a 15mm upstand exposed when positioned in the shelf.

Euro Hook with Overarm



SIZE (MM)
200

The Euro Hook with overarm is designed to fit securely with Tie Bar.

EPOS Tag for Overarm



SIZE (MM)	FINISH
70 x 40	Clear

EPOS overarm tags clip onto the overarm section of a hook allowing the display of product information and pricing.

EPOS Ticket Moulding (Scanning)

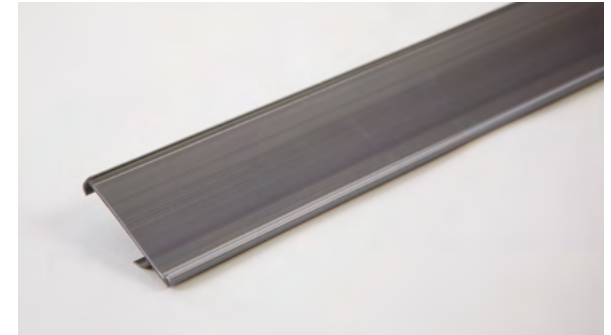

SHELF WIDTH (MM)
665
1000
1250

EPOS ticket moulding (scanning) is ideal for displaying pricing information whilst adding the finishing touch to any shelf. Our ticket moulding accepts a 39mm price ticket.

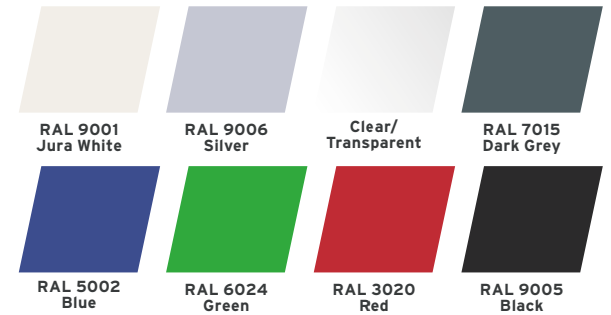



Evolve S50i Shelving Collection

Retail Shelving Solutions

EVOLVE S50i

EVOLVE S50i

EVOLVE S50i is a first class range of retail fittings and provides exceptional value for money. It is independently designed offering a comprehensive solution to your shop fitting requirements. Q-System is a perfect addition to this extensive range.



Our prices are the most competitive in the market and we can provide you with fast, reliable deliveries exactly when you want them.

Look at all the benefits on offer:

- ▶ Generic 50mm pitch system
- ▶ Superior finish
- ▶ Stronger weight loading
- ▶ Multiple Colours: Jura, Silver, Black - any special colour to order
- ▶ Matching colours for plinths and ticket strips
- ▶ Special colours at standard prices
- ▶ Exceptional value for money
- ▶ Bay widths: 500mm, 665mm, 800mm, 1000mm, 1250mm
- ▶ Superior packaging to protect against damages
- ▶ Large stockholding - 25,000 Sq.ft warehouse
- ▶ Bakery shelves
- ▶ Wire shelving range
- ▶ Full range of accessories:
 - Perforated, Slatwall & Bar Hooks in Euro and Single
 - Fruit & Veg shelves, Banana hammocks
 - PETG 1, 2 & 3 tier Magazine shelves in 70+ 110mm depths
 - Merchandising Bins
- ▶ 24 hour delivery

Wall Bays

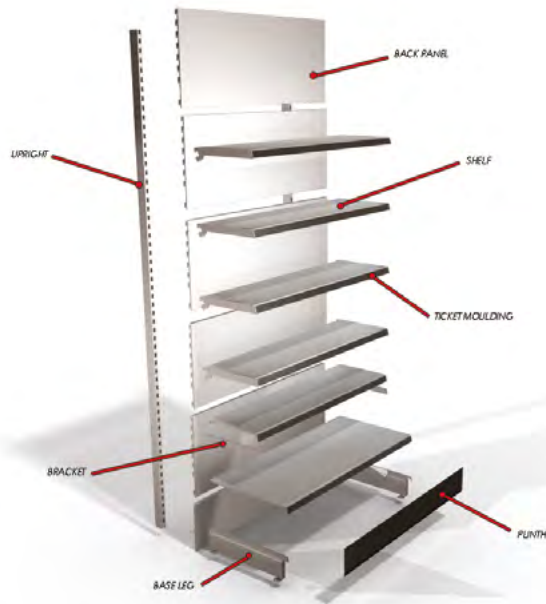

This drawing is designed to illustrate the various components which are required in the construction of a single sided wall bay.

Gondola Bays

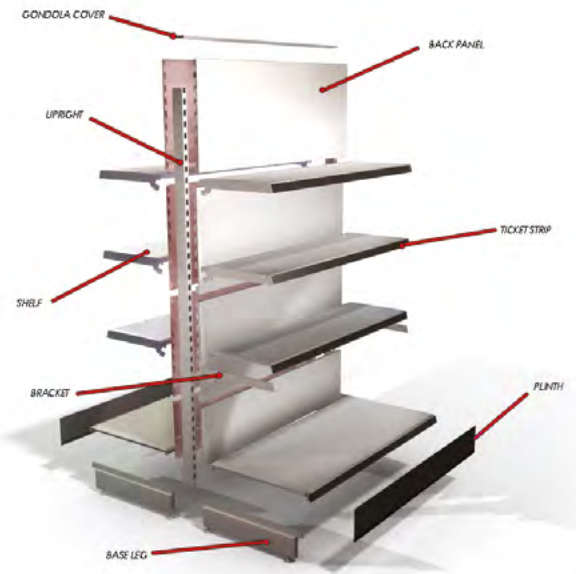

This drawing is designed to illustrate the various components which are required in the construction of a double sided gondola bay.

Dimensions

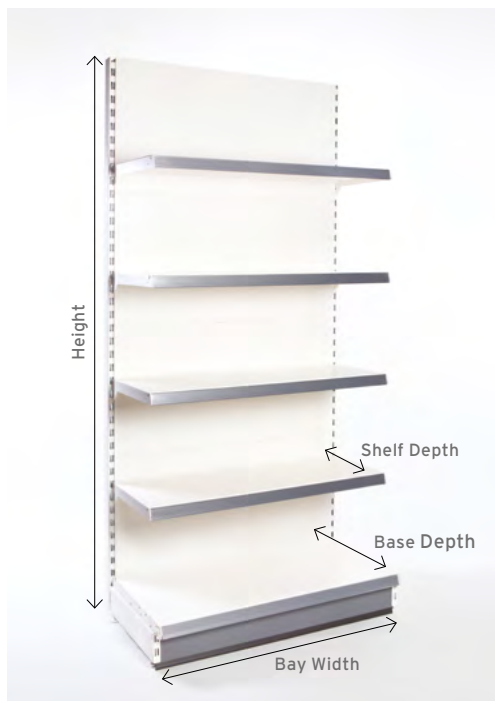

UPRIGHT HEIGHTS	BAY WIDTHS	SHELF DEPTHS
1200mm	500mm	200mm
1400mm	665mm	250mm
1600mm	800mm	300mm
1800mm	1000mm	370mm
2000mm	1250mm	470mm
2100mm	BASE DEPTHS	570mm
2200mm	200mm	670mm
2400mm	300mm	770mm
2600mm	370mm	
2800mm	470mm	
3000mm	570mm	
	670mm	
	770mm	

Types of Back Panels



Plain Panels

HEIGHTS AVAILABLE
100mm
200mm
300mm
400mm
500mm
WIDTHS AVAILABLE
500mm
665mm
800mm
1000mm
1250mm

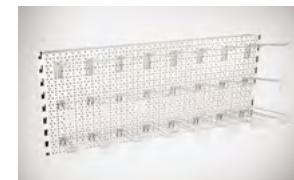

Perforated Panels

HEIGHTS AVAILABLE
400mm
WIDTHS AVAILABLE
500mm
665mm
800mm
1000mm
1250mm



Slatted Panels

HEIGHTS AVAILABLE
100mm
WIDTHS AVAILABLE
500mm
665mm
800mm
1000mm
1250mm

Shelves

Standard Shelves

Can be placed to sit in a level or sloped position.



WIDTHS AVAILABLE	DEPTHS AVAILABLE
500mm	200mm
665mm	250mm
800mm	300mm
1000mm	370mm
1250mm	470mm
	570mm
	670mm
	770mm

Single Sided Wall Bay

A single sided wall bay is ideal for wall perimeter shelving and is adaptable for multiple shop environments.



Benefits:

- ▶ Strong and versatile
- ▶ Quick and easy to assemble
- ▶ Available in a variety of sizes

Double Sided Gondola Bay

A double sided gondola bay is the perfect solution for creating central aisle shelving.



Benefits:

- ▶ Compliments single sided wall bays
- ▶ Available in various heights and widths to suit all shop environments
- ▶ Accessories available

Gondola End Bay

A gondola end bay neatly completes any double sided gondola run adding maximum selling space within the shop environment.



Benefits:

- ▶ Ideal for seasonal displays
- ▶ Maximises in store promotions
- ▶ Creates impulse sales

Internal 90 Degree Corner Bay

A 90 degree internal corner bay is the perfect solution for maximising all available space within an internal corner.



Benefits:

- ▶ Utilises space efficiently
- ▶ Special Internal B-Panels with pre bent lugs
- ▶ Allows wall bays to connect into a corner

Internal 90/45 Degree Corner Bay

A 90/45 degree internal corner bay is the display solution for continuing a wall run into an internal corner where there is plumbing or gas work pipes present.



Benefits:

- ▶ Special Internal B-Panels with pre bent lugs
- ▶ Accommodates internal corners with works pipes
- ▶ Allows wall bays to connect into an internal corner

External 90 Degree Corner Bay

An external corner bay allows a run of shelving to continue around the outside of a 90 degree external wall.



Benefits:

- ▶ Easy and efficient to use
- ▶ Compliments single sided wall bay runs
- ▶ Utilises display space efficiently

Perforated Wall Bay & Perforated Panel with Hooks

A perforated wall bay creates a display solution ideal for all hanging products.



Benefits:

- ▶ A variety of hook types and sizes available
- ▶ High strength perforated back panels
- ▶ EPOS tags available

Slatwall Bay & Slatwall Panel with Hooks

A slatwall bay creates a display solution ideal for all hanging products.



Benefits:

- ▶ A variety of hook types & sizes available
- ▶ High strength slatwall panels
- ▶ Maximises display space

Garment Rail & Oval Rear Support Bar with Notched Arm Bay

Garment rails and oval rear support bars with sloping notched arms are easy and convenient ways to display clothing and hanging goods.



Benefits:

- ▶ Stylish chrome finish
- ▶ Available to suit 1000 & 1250mm modules
- ▶ Quick and easy to install

Magazine Bay

A tiered magazine bay is designed to merchandise magazines in high volume whilst maintaining a professional finish. Manufactured in a strong PETG material offering clear product visibility for maximum impact.



Benefits:

- ▶ Clear strong PETG material
- ▶ Available to fit all standard bay sizes
- ▶ 1, 2 & 3 tiered displays available for maximum merchandising

Newspaper Bay

A newspaper bay is the optimum way of displaying newspapers in high volume. Easy to install and manufactured from high quality PETG material for maximum product visibility.



- Benefits:**
- ▶ Clear PETG material
 - ▶ Strong and flexible display
 - ▶ Maximises product impact

Card Bay

A tiered card bay allows greeting cards to be stocked in high volume, offering the opportunity for displaying a comprehensive range.



- Benefits:**
- ▶ Clear PETG material
 - ▶ Superior visibility and product impact
 - ▶ 2, 4, 6, 10 & 12 tiered displays available

Crisp Bay

A crisp bay creates a fantastic display solution for all bagged crisp and snack goods. Brilliant for high impact point of sale as well as impulse sales.



- Benefits:**
- ▶ Clear PETG material
 - ▶ Strong product impact and visibility
 - ▶ Crisp shelves include dividers as standard



Fruit & Vegetable Bay



A fruit & vegetable bay will provide the most effective display for fresh fruit and vegetable produce. The purpose made sloping shelves are designed to take box crates and large baskets for maximum produce exposure.

Benefits:

- ▶ Purpose made, high quality fruit & vegetable shelves
- ▶ Available in 450mm & 600mm deep sizes for all bay widths
- ▶ Accommodates box crates and green produce baskets

Bakery Bay



A bakery bay is the perfect display solution for fresh bread and cakes as well as all baked goods. Wire shelves provide great versatility and a first class visual impact.

Benefits:

- ▶ High quality wire shelves
- ▶ Shelves can accommodate wire or acrylic risers
- ▶ Creates fantastic product impact

Wire Basket Bay



A wire basket bay is a flexible display solution for loose packaged or boxed merchandise.

Benefits:

- ▶ Matching dividers available
- ▶ Free standing and stackable
- ▶ Ideal for packaged foods and crisps



Our shelving system is based on a 50mm pitch which has become the benchmark for much of the retail industry.

Shelf with Scanning



Standard shelves provide a solid one piece display surface.

Benefits:

- ▶ Available to fit all standard bay sizes
- ▶ Can be positioned level or sloped
- ▶ Accessories available

Shelf with Wire

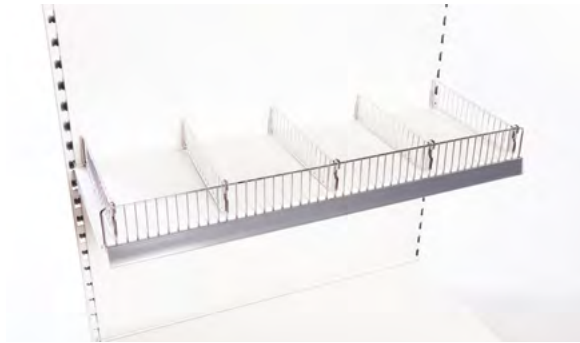

Wire risers locate into the groove at the front of a shelf to prevent products falling off the shelf whilst providing a stylish finish to the bay.

Benefits:

- ▶ Supplied in a chrome finish
- ▶ Available to fit all standard bays
- ▶ Available in 75mm and 150mm heights

Gift Wrap Arm



A gift wrap arm is a perfect solution for the hanging and display of individual sheets of gift wrap paper.

Benefits:

- ▶ Flexible display in any position on the bay
- ▶ Quick and easy to assemble
- ▶ Available in a 550mm depth

Shelf with Acrylic

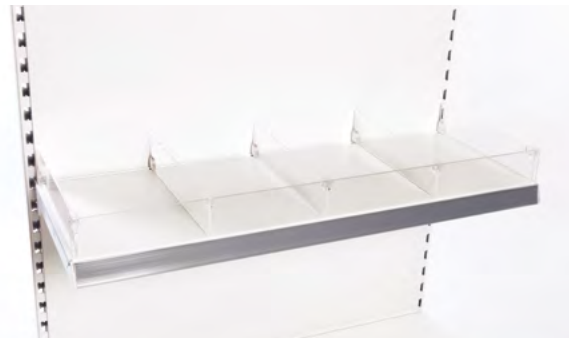

Acrylic risers locate into the front groove of a shelf to prevent products falling or rolling off the shelf whilst in position. Clear acrylic material provides a stylish professional finish.

Benefits:

- ▶ Available in a high quality clear finish
- ▶ Available to fit all standard bays
- ▶ Strong and easy to use

Shelf with Plastic

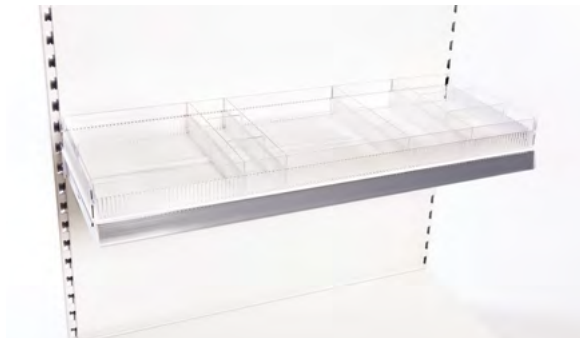

Plastic risers locate into the groove at the front shelf to prevent products falling off the shelf whilst providing a stylish finish to the bay.

Benefits:

- ▶ Available to fit 665, 1000 and 1250mm bay sizes
- ▶ Plain and toothed dividers available to suit
- ▶ Can sub divide to create small compartments

Sloping Holder Bay



A sloping holder display is the perfect solution for angled signage or acrylic mirrored sections.

Benefits:

- ▶ Available in 400mm height
- ▶ Inclines upwards at a 45 degree angle
- ▶ Fits branded signage to create a stylish finish to any bay

Shopping Baskets

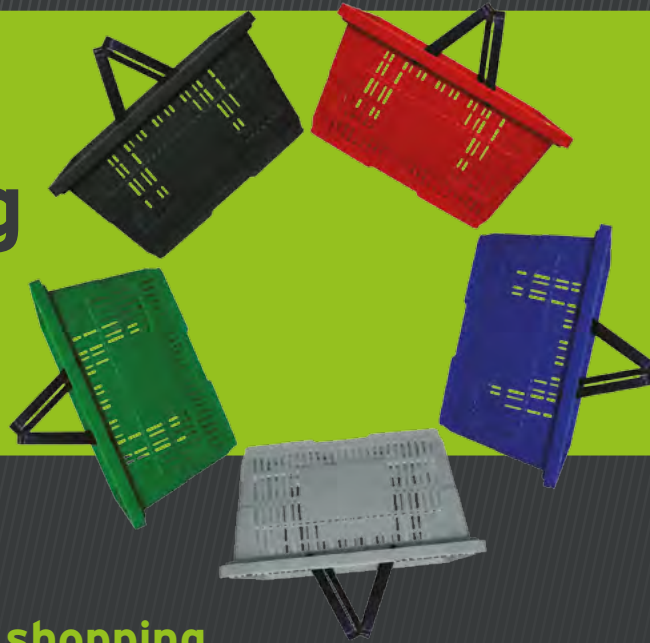

Here's why our shopping baskets are a best seller:

- ▶ They are made from high quality injection moulding ensuring durability and extremely neat stacking
- ▶ They are hygienic - easy to wash down
- ▶ They have double handles for greater stability
- ▶ They are available in 5 modern colours, Green, Red, Blue, Black and Grey (matching our scanning ticket moulding & plinths)
- ▶ Two convenient sizes: 22 litre & 30 litre
- ▶ Best value for money





Dealer stamp

EVOLVE Q50i