



Passion for Tools



**APPLICATION SOLUTIONS
CONTROL CABINET AND CONTROL ENGINEERING**

PASSION MADE IN GERMANY

By definition, a catalogue provides the list of a range of products. In our switchboard and control engineering catalogue, we at ALFRA want to show you more than photos and facts. For over 40 years we have been producing sheet metal hole punches for this specialist area – on sites in Germany. The 116 bound A4 pages therefore initially hold accumulated experience. Furthermore, we see it as an expression of our corporate philosophy, “passion for tools”. We pursue our goals with passion – for precision, for quality, and above all for your needs as the customer. As such, we regard ourselves as a solution provider in the traditional sense. Our tools are developed by practitioners for practitioners – on the basis of intensively fostered customer relationships, produced in Hockenheim and Berlin/Stahnsdorf.

Because we want to get better and better for you, many additional products have also emerged over the decades, for example: hydraulic hand punches for effortless operation of sheet metal hole punches, cutters for mounting rails, machines and tools for working on the power rail or stationary punching machines for efficient working on switchboards and housings. In the catalogue, you will find our classics – in cutting-edge improved design.

From the beginning, the label “made in Germany” has been a trademark for all these developments – a promise from which customers now benefit all over the world. An example: the ALFRA® TriCut® type hole punch (see page 10) has three blades, to completely eliminate jamming when the punch breaks through. The material and payment here are selected such that the highest standards of quality and service life are met.

We are proud of our new ball bearing screws (see page 7). In a complex production process, our employees package the bearing in a protective aluminium cage – the perfect barrier to dust, dirt and external mechanical influences. Your advantage: a tool with optimal cost/benefit effect and minimum effort.

The ALFRA quality standards naturally apply for all products that leave our premises. Measure us against them, as we want to deliver no less to you.

We hope you enjoy browsing our new catalogue.



WE THINK AHEAD



Certified energy awareness at ALFRA

Our products ensure smooth processes in the working environment of our customers. We are proud of this. However, it is not only quality that counts for us but also how we get there. Sustainability is therefore not an empty phrase for ALFRA; our commitment with regard to energy awareness has been certified in accordance with the ISO standard since 1997.

400 tonnes fewer CO₂ emissions

The figures prove it: we "are not just talking about it". With 400 tonnes fewer CO₂ emissions in four years, we are making our contribution in the fight against climate change.

600 megawatt hours of electricity for our own needs

As a manufacturer, we determine the entire production process in accordance with our philosophy. Specifically: ALFRA relies on alternative energies wherever this makes sense, for example with electricity from photovoltaics. 600 megawatt hours of energy from solar cells facilitate almost climate-neutral production.

We feel responsible – for the satisfaction of our customers and for environmentally friendly production. The aim: to do our best for both every day.



 **MADE IN GERMANY**



CONTENTS

TOOLS AND MACHINES FOR CONTROL ENGINEERING



**Hole punchers
MonoCut®/sets**

Pages 8 - 9



**Split hole punchers
TriCut®/sets**

Pages 10 - 11



**Split hole punchers
TriCut+®/sets**

Pages 12 - 13



**Split hole punchers
TwinCut®/sets**

Pages 14 - 15



**Split hole punchers
FormCut®**

Pages 16 - 17



**Split hole punchers
FormCut®**

Pages 18 - 19



**Hole punchers
Sanitary/Sub-Min-D**

Pages 20 - 21



**Hole punchers
special forms/
custom-made products**

Pages 22 - 23



**Manual hydraulic
punchers/sets**

Pages 24 - 33



Akku-Compact Flex®

Pages 31 - 32



Hydraulic pumps

Pages 33 - 36



**Accessories/
Notch pliers**

Pages 37 - 39





CONTENTS

 <p>PSG Cutting devices for Profile rails</p>	 <p>Wiring duct cutting device</p>	 <p>Assembly tables AMT 150, AMTE 250</p>
<p>Pages 40 - 47</p>	<p>Pages 48 - 49</p>	<p>Pages 50 - 53</p>
 <p>Busbar Machining</p>	 <p>Crimping devices Cable cutters</p>	 <p>ALFRA PRESS Stationary punching machines</p>
<p>Pages 54 - 63</p>	<p>Pages 64 - 65</p>	<p>Pages 66 - 81</p>

CUTTING TOOLS

 <p>TCT-Hole Saws MBS-Light</p>	 <p>Hole Saws HSS-Bi-Metal/Sets</p>	 <p>Multi-Step Drills Conical One-Lip Bits</p>	 <p>Milford Sabre Saw Blades</p>
<p>Pages 82 - 92</p>	<p>Pages 93 - 96</p>	<p>Pages 97 - 100</p>	<p>Pages 101 - 103</p>

ALFRA HOLE PUNCHERS® APPLICATION OVERVIEW

	FOR STAINLESS STEEL (VA)			
	FOR SHEET STEEL (S235)			
	 ALFRA HOLE PUNCHERS® MonoCut®	 ALFRA HOLE PUNCHERS® TriCut®	 ALFRA HOLE PUNCHERS® TriCut+®	 ALFRA HOLE PUNCHERS® TwinCut®
Material thickness when using				
Ø 6 mm draw bolt	-	1.5 mm	-	-
Ø 9.5 mm draw bolt	2 mm	2 mm	-	2 mm
Ø 11.1 mm draw bolt	-	-	2 mm	2.5 mm
Ø 19 mm draw bolt	3 mm	3 mm	2.5 mm	3 mm
Diameter	12.7 mm M12 PG7 up to 152 mm	12.7 mm M12 PG7 up to 63.5 mm M63	15.2 mm PG9 up to 63.5 mm M63	12.7 mm M12 PG7 up to 63.5 mm M63
custom-made products	✓	✓	✓	✓
Ø for predrilling				
Ø 6 mm draw bolt	-	6.2 mm	-	-
Ø 9.5 mm draw bolt	11 mm	10 mm	-	10 mm
Ø 11.1 mm draw bolt	-	-	11.5 mm	11.5 mm
Ø 19 mm draw bolt	20.5 mm	19.5 mm	19.5 mm	19.5 mm
Ø 28.3 mm draw bolt	30.5 mm	-	-	-
Machining possibilities using				
wrench or ratchet	Up to Ø 89 mm ✓	✓	✓	✓
Hydraulic drive	✓	✓	✓	✓

BALL BEARING SCREW

- 1 High-tensile bolts for the toughest operating conditions
- 2 Protrusion of ball bearing outside protective ring ensures perfect force transmission to wrench or punching tool
- 3 Ball bearings encapsulated in aluminium rings. Extremely long-life and perfectly protected against soiling
- 4 UNF fine thread



ALFRA HOLE PUNCHER® MONOCUT®



Hole puncher MonoCut® for sheet steel (S235)

- 1 With UNF fine thread
- 2 With 4 crosshair markings for simple, central alignment



“The max. material thickness for which a hole puncher can be used always depends on the screw and draw bolts used.”

Usable up to a material thickness of:

- 3.0 mm sheet steel with 3/4" (19.0 mm) screw or draw bolt
- 2.0 mm sheet steel with 3/8" (9.5 mm) screw or draw bolt

Hole puncher MonoCut® – sets



All sets are supplied in heavy-duty practical plastic cases.

Ø mm	12.7	15.2	16.2	18.6	19.0	20.4	22.5	25.4	28.3	30.5	31.7	32.5	34.6	37.0	38.0	40.5	43.2	47.0	49.6	50.5	54.0	60.0	61.5	63.5
Ø metric	M12	-	M16	-	-	M20	-	M25	-	-	-	M32	-	-	-	M40	-	-	-	M50	-	-	-	M63
Ø PG	7	9	-	11	-	13	16	-	21	-	-	-	-	29	-	-	-	36	-	-	42	48	-	-
Ø Inch	1/2"	-	-	-	3/4"	-	7/8"	1"	-	1-7/32"	1-1/4"	-	-	-	1-1/2"	-	1-11/16"	-	1-15/16"	-	2-1/8"	-	2-3/8"	2-1/2"
	0.5	0,598	0,638	0,732	0,748	0,803	0,886	1.0	1,114	1,201	1,248	1,280	1,362	1,457	1,496	1,594	1,701	1,850	1,953	1,988	2,126	2,362	2,421	2.5
Ø Conduit	-	-	-	-	-	-	1/2"	-	3/4"	-	-	-	1"	-	-	-	1 1/4"	-	1 1/2"	-	-	-	2"	-

Prod.-No.	12.7	15.2	16.2	18.6	19.0	20.4	22.5	25.4	28.3	30.5	31.7	32.5	34.6	37.0	38.0	40.5	43.2	47.0	49.6	50.5	54.0	60.0	61.5	63.5
01290			•			•		•				•				•								
01291			•			•		•				•				•				•				•
01298	•	•		•		•	•		•	•				•				•				•	•	
01459							•		•				•				•		•					•
01463	•				•			•			•				•					•				
01451		•		•		•	•		•															

+ 2 joint screws Ø 9.5 x 50.0 mm, 1 pre-drill HSS Ø 11.0 mm, 1 tube lubricating paste

ALFRA HOLE PUNCHER® MONOCUT®

Ø in mm	Max. Material thickness in mm (S235)	Size Metric	Size PG	Size Inch	Size Conduit & Pipe Size							
						Punches and dies		matching draw bolt	matching draw bolt	matching draw bolt with ball bearing		
						draw bolt with ball bearing	draw bolt					
Prod.-No.												
12.7	2.0	M 12	7	1/2"	0.500	-	01002	01001	02003	01335		
14.3	2.0	-	-	9/16"	0.563	-	01014	01013				
15.2	2.0	-	9	-	0.598	-	01006	01005				
16.0	2.0	-	-	-	0.630	-	01016	01015				
16.2	2.0	M 16	-	-	0.638	-	01010	01009				
17.5	2.0	-	-	11/16"	0.689	-	01018	01017				
18.6	2.0	-	11	-	0.732	-	01022	01021				
19.0	2.0	-	-	3/4"	0.748	-	01026	01025				
20.0	2.0	-	-	-	0.787	-	01030	01029				
20.4	2.0	M 20	13	-	0.803	-	01034	01033				
20.6	2.0	-	-	13/16"	0.811	-	01038	01037				
22.0	2.0	-	-	-	0.866	-	01042	01041				
22.5	2.0	-	16	7/8"	0.886	1/2"	01046	01045				
23.8	2.0	-	-	15/16"	0.937	-	01050	01049				
25.0	2.0	-	-	-	0.984	-	01054	01053				
25.4	2.0	M 25	-	1"	1.000	-	01058	01057				
27.0	2.0	-	-	1-1/16"	1.063	-	01078	01077				
28.3	2.0	-	21	-	1.114	3/4"	01070	01069				
28.3	3.0	-	21	-	1.114	3/4"	01074	01073				
28.6	2.0	-	-	1-1/8"	1.126	-	01080	01079				
30.1	2.0	-	-	-	1.185	-	01086	01085				
30.5	2.0	-	-	1-7/32"	1.201	-	01094	01093				
31.7	2.0	-	-	1-1/4"	1.248	-	01102	01101				
32.5	2.0	M 32	-	-	1.280	-	01106	01105				
33.4	2.0	-	-	1-5/16"	1.315	-	01110	01109				
34.6	3.0	-	-	1-11/32"	1.362	1"	01118	01117				
35.0	2.0	-	-	1-3/8"	1.378	-	01122	01121				
35.0	3.0	-	-	1-3/8"	1.378	-	01126	01125				
37.0	3.0	-	29	-	1.457	-	01130	01129				
38.0	3.0	-	-	1-1/2"	1.496	-	01134	01133				
40.5	3.0	M 40	-	-	1.594	-	01150	01149				
41.3	3.0	-	-	1-5/8"	1.626	-	01154	01153				
42.8	3.0	-	-	-	1.685	-	01158	01157				
43.2	3.0	-	-	1-11/16"	1.701	1 1/4"	01162	01161				
44.5	3.0	-	-	1-3/4"	1.752	-	01164	01163				
47.0	3.0	-	36	-	1.850	-	01166	01165				
47.6	3.0	-	-	1-7/8"	1.874	-	01182	01181				
49.6	3.0	-	-	1-15/16"	1.953	1 1/2"	01170	01169				
50.5	3.0	M 50	-	-	1.988	-	01178	01177				
54.0	3.0	-	42	2-1/8"	2.126	-	01190	01189				
57.2	3.0	-	-	2-1/4"	2.252	-	01194	01193				
60.0	3.0	-	48	-	2.362	-	01202	01201				
61.5	3.0	-	-	2-3/8"	2.421	2"	01206	01205				
63.5	3.0	M 63	-	2-1/2"	2.500	-	01210	01209				
66.7	3.0	-	-	2-5/8"	2.626	-	01214	01213				
Above Ø 68.0 mm we recommend the use of hydraulic equipment.												
68.0	3.0	-	-	-	2.677	-	01242	01241	02002	01338		
70.0	3.0	-	-	2-3/4"	2.756	-	01222	01221				
70.6	3.0	-	-	-	2.780	-	01220	01219				
74.0	3.0	-	-	2-7/8"	2.913	2 1/2"	01234	01233				
75.5	3.0	M 75	-	2-7/8"	2.972	-	01226	01225				
76.2	3.0	-	-	3"	3.000	-	01230	01229				
80.0	3.0	-	-	3-1/8"	3.150	-	01238	01237				
82.0	3.0	-	-	-	3.228	-	01246	01245				
Above 89.0 mm. the use of hydraulic equipment is generally required.								Required accessories:				
						Punch	Die	draw bolt			special draw bolt	counternut
89.0	3.0	-	-	3-1/2"	3.504	3"	01251	01252	01398	01398L		
92.0	3.0	-	-	3-5/8"	3.622	-	01253	01254				
100.5	3.0	-	-	-	3.957	-	01257	01258				
115.5	3.0	-	-	4-1/2"	4.547	4"	01265	01266				
120.0	3.0	-	-	-	4.724	-	01267	01268				

ALFRA SPLIT HOLE PUNCHER TRICUT®



Split hole puncher TriCut® for sheet steel (S235)

- 1 With 3-fold split
- 2 With UNF fine thread
- 3 With 4 crosshair markings for simple, central alignment



"The max. material thickness for which a hole puncher can be used always depends on the screw and draw bolts used."

Usable up to a material thickness of:

- 3.0 mm sheet steel with 3/4" (19.0 mm) screw or draw bolt
- 2.0 mm sheet steel with 3/8" (9.5 mm) screw or draw bolt
- 1.5 mm steel sheet with M6 (6.0 mm) screw or draw bolt

Split hole puncher TriCut® - sets



All sets are supplied in heavy-duty practical plastic cases.

Ø mm	12.5	15.2	16.2	18.6	19.0	20.4	22.5	25.4	28.3	30.5	31.7	32.5	34.6	37.0	38.0	40.5	43.2	47.0	49.6	50.5	54.0	60.0	61.5	63.5
Ø metric	M12	-	M 16	-	-	M 20	-	M 25	-	-	-	M 32	-	-	-	M 40	-	-	-	M 50	-	-	-	M 63
Ø PG	7	9	-	11	-	13	16	-	21	-	-	-	-	29	-	-	-	36	-	-	42	48	-	-
Ø Inch	1/2"	-	-	-	3/4"	-	7/8"	1"	-	1-7/32"	1-1/4"	-	-	-	1-1/2"	-	1-11/16"	-	1-15/16"	-	2-1/8"	-	2-3/8"	2-1/2"
Ø Conduit	-	-	-	-	-	-	1/2"	-	3/4"	-	-	-	1"	-	-	-	1 1/4"	-	1 1/2"	-	-	-	2"	-
Prod.-No.																								
01762			•			•		•				•				•								
01757			•			•		•				•				•				•				•
01760							•		•				•				•		•				•	
01761	•				•			•			•				•					•				
01754	•		•			•		•				•				•								
	+ 1 ball bearing screw Ø 6.0 x 40.0 mm, 1 ball bearing screw Ø 9.5 x 50.0 mm, 1 ball bearing screw Ø 19.0 x 55.0 mm, 1 pre-drill HSS Ø 10.0 mm, 1 can lubricating paste																							
01755			•			•		•				•				•				•				•
	+ 2 ball bearing screws Ø 9.5 x 50.0 mm, 1 ball bearing screw Ø 19.0 x 55.0 mm, 1 ball bearing screw Ø 19.0 x 75.0 mm, 1 pre-drill HSS Ø 10.0 mm, 1 can lubricating paste																							
01750			•		•		•	•		•	•													
	+ 2 ball bearing screws Ø 9.5 x 50.0 mm, 1 pre-drill HSS Ø 10.0 mm, 1 tube lubricating paste																							
01751	•		•		•	•		•	•					•					•			•	•	
	+ 2 ball bearing screws Ø 9.5 x 50.0 mm, 1 ball bearing screw Ø 19.0 x 55.0 mm, 1 ball bearing screw Ø 19.0 x 75.0 mm, 1 pre-drill HSS Ø 10.0 mm, 1 can lubricating paste																							

ALFRA SPLIT HOLE PUNCHER TRICUT®

Ø in mm	Max. Material thickness in mm (S235)	Size Metric	Size PG	Size Inch		Size Conduit & Pipe Size				
							Punches and dies, draw bolt with ball bearing	Punches and dies	matching draw bolt	matching draw bolt with ball bearing
							Prod.-No.			
12.5	1.5	M 12	7	1/2"	0.500	-	01674	01770	02022	01334
15.2	2.0	-	9	-	0.598	-	01680	01771	02003	01339
16.2	2.0	M 16	-	-	0.638	-	01683	01772		
18.6	2.0	-	11	-	0.732	-	01686	01773		
20.4	2.0	M 20	13	-	0.803	-	01689	01774		
22.5	2.0	-	16	7/8"	0.886	1/2"	01692	01775		
25.4	2.0	M 25	-	1"	1.000	-	01695	01776		
28.3	2.0	-	21	-	1.114	3/4"	01698	01777		
28.3	3.0	-	21	-	1.114	3/4"	01701	01778	02002	01340
30.5	2.0	-	-	1-7/32"	1.201	-	01703	01779	02003	01339
32.5	3.0	M 32	-	-	1.280	-	01708	01780	02002	01341
34.6	3.0	-	-	1-11/32"	1.362	1"	01711	01788		
37.0	3.0	-	29	-	1.457	-	01713	01781		
40.5	3.0	M 40	-	-	1.594	-	01715	01782		
43.2	3.0	-	-	1-11/16"	1.701	1 1/4"	01718	01789		
47.0	3.0	-	36	-	1.850	-	01720	01783		
49.6	3.0	-	-	1-15/16"	1.953	1 1/2"	01723	01790		
50.5	3.0	M 50	-	-	1.988	-	01736	01784		
54.0	3.0	-	42	2-1/8"	2.126	-	01727	01785		
60.0	3.0	-	48	-	2.362	-	01729	01786		
61.5	3.0	-	-	2-3/8"	2.421	2"	01732	01791		
63.5	3.0	M 63	-	2-1/2"	2.500	-	01739	01787		

ALFRA SPLIT HOLE PUNCHER TRICUT+®



Split hole puncher TriCut+® for sheet steel (S235) and stainless steel

- 1 With 3-fold split
- 2 With UNF fine thread
- 3 With 4 crosshair markings for simple, central alignment



"The max. material thickness for which a hole puncher can be used always depends on the screw and draw bolts used."

Usable up to a material thickness of:

- 2.5 mm stainless steel with 3/4" (19.0 mm) screw or draw bolt
- 2.0 mm stainless steel with 7/16" (11.1 mm) screw or draw bolt

Split hole puncher TriCut+® - sets



All sets are supplied in heavy-duty practical plastic cases.

Ø mm	15.2	16.2	18.6	19.0	20.4	22.5	25.4	28.3	30.5	31.7	32.5	34.6	37.0	38.0	40.5	43.2	47.0	49.6	50.5	54.0	60.0	61.5	63.5
Ø metric	-	M 16	-	-	M 20	-	M 25	-	-	-	M 32	-	-	-	M 40	-	-	-	M 50	-	-	-	M 63
Ø PG	9	-	11	-	13	16	-	21	-	-	-	-	29	-	-	-	36	-	-	42	48	-	-
Ø Inch	-	-	-	3/4"	-	7/8"	1"	-	1-7/32"	1-1/4"	-	-	-	1-1/2"	-	1-11/16"	-	1-15/16"	-	2-1/8"	-	2-3/8"	2-1/2"
Ø Conduit	-	-	-	-	-	1/2"	-	3/4"	-	-	-	1"	-	-	-	1 1/4"	-	1 1/2"	-	-	-	2"	-
Prod.-No.																							
01652		•			•		•				•				•								
01653		•			•		•				•				•				•				•
01645						•		•				•				•		•				•	
01646				•			•			•				•					•				

ALFRA SPLIT HOLE PUNCHER TRICUT+®

Ø in mm	Max. Material thickness in mm (VA)	Size Metric	Size PG	Size Inch		Size Conduit & Pipe Size	 Punches and dies, draw bolt with ball bearing	 Punches and dies	 matching draw bolt	 matching draw bolt with ball bearing	Prod.-No.	
15.2	2.0	-	9	-	0.598	-	01465	01600	02007	01342		
16.2	2.0	M 16	-	-	0.638	-	01466	01656				
18.6	2.0	-	11	-	0.732	-	01467	01603				
20.4	2.0	M 20	13	-	0.803	-	01468	01606				
22.5	2.0	-	16	7/8"	0.886	1/2"	01469	01609				
25.4	2.5	M 25	-	1"	1.000	-	01470	01659				
28.3	2.5	-	21	-	1.114	3/4"	01471	01612	02002	01340		
30.5	2.5	-	-	1-7/32"	1.201	-	01472	01615				
32.5	2.5	M 32	-	-	1.280	-	01473	01662				
34.6	2.5	-	-	1-11/32"	1.362	1"	01474	01618				
37.0	2.5	-	29	-	1.457	-	01475	01621				
40.5	2.5	M 40	-	-	1.594	-	01476	01665				
43.2	2.5	-	-	1-11/16"	1.701	1 1/4"	01477	01624				
47.0	2.5	-	36	-	1.850	-	01478	01627				
49.6	2.5	-	-	1-15/16"	1.953	1 1/2"	01479	01630				
50.5	2.5	M 50	-	-	1.988	-	01480	01668				
54.0	2.5	-	42	2-1/8"	2.126	-	01481	01633				
60.0	2.5	-	48	-	2.362	-	01482	01636				
61.5	2.5	-	-	2-3/8"	2.421	2"	01483	01640				
63.5	2.5	M 63	-	2-1/2"	2.500	-	01484	01671				

ALFRA SPLIT HOLE PUNCHER TWINCUT®



Split hole puncher TwinCut® for sheet steel (S235) and stainless steel

- 1 With 2-fold split
- 2 With UNF fine thread
- 3 With 4 crosshair markings for simple, central alignment



EDELSTAHL
STAINLESS STEEL

“The max. material thickness for which a hole puncher can be used always depends on the screw and draw bolts used.”

Usable up to a material thickness of:

- 3.0 mm stainless steel with 3/4" (19.0 mm) screw or draw bolt
- 2.5 mm stainless steel with 7/16" (11.1 mm) screw or draw bolt
- 2.0 mm stainless steel with 3/8" (9.5 mm) screw or draw bolt

Split hole puncher TwinCut® - sets



All sets are supplied in heavy-duty practical plastic cases.

Ø mm	12.7	15.2	16.2	18.6	19.0	20.4	22.5	25.4	28.3	30.5	31.7	32.5	34.6	37.0	38.0	40.5	43.2	47.0	49.6	50.5	54.0	60.0	61.5	63.5
Ø metric	M12	-	M 16	-	-	M 20	-	M 25	-	-	-	M 32	-	-	-	M 40	-	-	-	M 50	-	-	-	M 63
Ø PG	7	9	-	11	-	13	16	-	21	-	-	-	-	29	-	-	-	36	-	-	42	48	-	-
Ø Inch	1/2"	-	-	-	3/4"	-	7/8"	1"	-	1-7/32"	1-1/4"	-	-	-	1-1/2"	-	1-11/16"	-	1-15/16"	-	2-1/8"	-	2-3/8"	2-1/2"
Ø Conduit	-	-	-	-	-	-	1/2"	-	3/4"	-	-	-	1"	-	-	-	1 1/4"	-	1 1/2"	-	-	-	-	2"
Prod.-No.																								
01566							•		•				•				•		•					•
01567	•				•			•							•						•			

ALFRA SPLIT HOLE PUNCHER TWINCUT®

Ø in mm	Max. Material thickness in mm (VA)	Size Metric	Size PG	Size Inch		Size Conduit & Pipe Size	 Punches and dies, draw bolt with ball bearing	 Punches and dies	 matching draw bolt	 matching draw bolt with ball bearing	Prod.-No.	
12.7	2.0	M 12	7	1/2"	0.500		01576	01510	02003	01339		
15.2	2.0	-	9	-	0.598	-	01577	01513				
16.2	2.0	M 16	-	-	0.638	-	01578	01516				
18.6	2.0	-	11	-	0.732	-	01579	01519				
20.4	2.5	M 20	13	-	0.803	-	01580	01522	02007	01342		
22.5	2.5	-	16	7/8"	0.886	1/2"	01581	01525				
25.4	2.5	M 25	-	1"	1.000	-	01582	01528				
28.3	3.0	-	21	-	1.114	3/4"	01583	01531				
30.5	3.0	-	-	1-7/32"	1.201	-	01584	01534	02002	01340		
32.5	3.0	M 32	-	-	1.280	-	01585	01537				
34.6	3.0	-	-	1-11/32"	1.362	1"	01586	01561				
37.0	3.0	-	29	-	1.457	-	01587	01540				
40.5	3.0	M 40	-	-	1.594	-	01588	01543				
43.2	3.0	-	-	1-11/16"	1.701	1 1/4"	01589	01562				
47.0	3.0	-	36	-	1.850	-	01590	01546				
49.6	3.0	-	-	1-15/16"	1.953	1 1/2"	01591	01563				
50.5	3.0	M 50	-	-	1.988	-	01592	01549				
54.0	3.0	-	42	2-1/8"	2.126	-	01593	01552				
60.0	3.0	-	48	-	2.362	-	01594	01555				
61.5	3.0	-	-	2-3/8"	2.421	2"	01595	01564				
63.5	3.0	M 63	-	2-1/2"	2.500	-	01596	01558				

ALFRA HOLE PUNCHER® FORMCUT®

Hole puncher FormCut® for sheet steel (S235)

- ① with sideways puncher part ejection
- ② With UNF fine thread
- ③ With 4 crosshair markings for simple, central alignment



 **MADE IN GERMANY**



③

“The max. material thickness at which a square or rectangular hole puncher (or even special tool) can be used always depends on the draw bolt and the cross-section of the tool (length x width or special shape).”

ALFRA HOLE PUNCHER® FORMCUT®

Size in mm	Max. Material thickness in mm (S235)	For use in	pre-drilling in mm	 incl. 1 - 4	1  draw bolt	2  counter nut	3  Ball bearing pressure nut	4  Adapter for hydraulic
------------	--------------------------------------	------------	--------------------	--	--	--	--	--

Hole puncher FormCut® – square – for sheet steel (S235)

					Prod.-No.				
12.7 x 12.7	1.75	●	●	10	01300	01348	01355	01352	01353
15.8 x 15.8	1.75	●	●	10	01301				
19.0 x 19.0	2.0	●	●	14	01302	01347	01351	01352	01353
21.3 x 21.3	2.0	●	●	14	01371				
22.2 x 22.2	2.0	●	●	14	01303				
24.0 x 24.0	2.0	●	●	14	01331	01360	01354	01359	01361
25.4 x 25.4	2.0	●	●	17	01304				
45.5 x 45.5	3.0		●	20	01313	01345	01350		
46.0 x 46.0	3.0		●	20	01305				
50.8 x 50.8	3.0		●	24	01306	01344	01349		
68.0 x 68.0	3.0		●	24	01308				
92.0 x 92.0	3.0		●	30	01309	01343	01356		
125.0 x 125.0	3.0		●	30	01431				
138.0 x 138.0	3.0		●	30	01311				

Hole puncher FormCut® – square – for heavy plug connectors – for sheet steel (S235)

46.0 x 46.0	3.0		●	20	01448	01345	01350		
-------------	-----	--	---	----	-------	-------	-------	--	--

Size in mm	Max. Material thickness in mm (S235)	Number of poles	For use in	pre-drilling in mm	 incl. 1 - 4	1  draw bolt	2  counter nut or bridge	3  Ball bearing pressure nut	4  Adapter for hydraulic
------------	--------------------------------------	-----------------	------------	--------------------	--	--	--	--	--

Hole puncher FormCut® – rectangular – for sheet steel (S235)

					Prod.-No.				
17.0 x 19.0	2.0		●	14	01317	01347	01351	01352	01353
21.8 x 25.8	2.0		●	17	01318				
22.0 x 30.0	2.0		●	17	01319	01360	01359	01361	
22.0 x 42.0	2.0		●	17	01320				
22.0 x 45.0	2.0		●	17	01434				
25.0 x 50.0	2.0		●	17	01332	01344	01349		
45.0 x 92.0	2.0		●	24	01314				
46.0 x 92.0	2.0		●	24	01329	01343	01358		
68.0 x 138.0	3.0		●	30	01330				

Hole puncher FormCut® – rectangular – for heavy plug connectors (S235) – for sheet steel (S235)

24.0 x 43.0	2.0		●	17	01436	01360	01351	01359	01361
24.0 x 65.0	2.0		●	24	01437				
24.0 x 86.0	2.0		●	24	01440	01345	01350		
24.0 x 112.0	2.0		●	30	01441				
36.0 x 52.0	2.0	6-pole	●	24	01325	01344	01350		
36.0 x 65.0	2.0	10-pole	●	24	01326				
36.0 x 86.0	2.0	16-pole	●	24	01327				
36.0 x 91.0	2.0		●	24	01323				
36.0 x 112.0	2.0	24-pole	●	24	01328				
46.0 x 86.0	2.0		●	24	01322				
46.0 x 112.0	2.0		●	30	01324	01343	01349		
66.0 x 112.0	2.0		●	30	01435				

ALFRA HOLE PUNCHER® FORMCUT+®







Hole puncher FormCut+® for sheet steel (S235) and stainless steel

- 1 with sideways puncher part ejection
- 2 With UNF fine thread
- 3 With 4 crosshair markings for simple, central alignment



“The max. material thickness at which a square or rectangular hole puncher (or even special tool) can be used always depends on the draw bolt and the cross-section of the tool (length x width or special shape).”

ALFRA HOLE PUNCHER® FORMCUT+®

Size in mm	Max. Material thickness in mm (VA)	For use in		pre-drilling in mm	 incl. 1 - 4	1	2	3	4
									

Hole puncher FormCut+® – square – for stainless steel (VA)

					Prod.-No.				
12.7 x 12.7	1.25	●	●	10	013001	01348	01355	01352	01353
15.8 x 15.8	1.25	●	●	10	013011				
19.0 x 19.0	1.5	●	●	14	013021	01347	01351	01352	01353
21.3 x 21.3	2.0	●	●	14	013711				
22.2 x 22.2	1.5	●	●	14	013031				
24.0 x 24.0	1.5	●	●	14	013311	01360	01354	01359	01361
25.4 x 25.4	1.5	●	●	17	013041				
45.5 x 45.5	2.0		●	20	013131	01345	01350		
46.0 x 46.0	2.0		●	20	013051				
50.8 x 50.8	2.0		●	24	013061	01344	01349		
68.0 x 68.0	2.0		●	24	013081				
92.0 x 92.0	2.0		●	30	013091	01343	01356		
125.0 x 125.0	2.0		●	30	014311				
138.0 x 138.0	2.0		●	30	013111				

Hole puncher FormCut+® – square – for heavy plug connectors – for stainless steel (VA)

46.0 x 46.0	3.0		●	20	014481	01345	01350		
-------------	-----	--	---	----	--------	-------	-------	--	--

Size in mm	Max. Material thickness in mm (VA)	Anzahl Pole	For use in		pre-drilling in mm	 incl. 1 - 4	1	2	3	4
										

Hole puncher FormCut+® – rectangular – for stainless steel (VA)

					Prod.-No.				
17.0 x 19.0	1.5		●	14	013171	01347	01351	01352	01353
21.8 x 25.8	1.5		●	17	013181				
22.0 x 30.0	1.5		●	17	013191	01360	01418	01359	01361
22.0 x 42.0	1.5		●	17	013201				
25.0 x 50.0	1.5		●	17	013321				
45.0 x 92.0	2.0		●	24	013141	01344	01349		
46.0 x 92.0	2.0		●	24	013291				
68.0 x 138.0	2.0		●	30	013301	01343	01358		

Hole puncher FormCut+® – rectangular – for heavy plug connectors – for stainless steel (VA)

36.0 x 52.0	2.0	6-pole		●	24	013251	01344	01350		
36.0 x 65.0	2.0	10-pole		●	24	013261				
36.0 x 86.0	2.0	16-pole		●	24	013271				
36.0 x 91.0	2.0			●	24	013231		01349		
36.0 x 112.0	2.0	24-pole		●	24	013281	01343	01357		
46.0 x 86.0	2.0			●	24	013221	01344	01349		
46.0 x 112.0	2.0			●	30	013241				

ALFRA HOLE PUNCHER® – SANITARY

- For punching out holes in washbasins

Size mm	Designation	Bolt size mm	Prod.-No.
Ø 28.3	Hole puncher complete	M 10 x 1	01293
Ø 31.7	Hole puncher complete	M 10 x 1	01294
Ø 35.0	Hole puncher complete	M 10 x 1	01295
Ø 37.0	Hole puncher complete	M 10 x 1	01292
	Draw bolt	M 10 x 1	01299



Prod.-No. 01450

Hole puncher set - sanitary	Prod.-No.
	01450

In plastic case

Contents: 3 hole punchers 28.3 + 31.7 + 35.0 mm

3 draw bolts M 10.0 x 1

1 ring open-ended wrench 17

ALFRA DUAL HOLE PUNCHERS – SANITARY

- For punching out holes in washbasins

- Spanner actuation size 19 mm

Size mm	Designation	Bolt size mm	Prod.-No.
28 and 32	hole punchers cpl.	10 x 55 special	01456
32 and 35	hole punchers cpl.	10 x 55 special	01460
	Draw bolt	10 x 55 special	01457



ALFRA HOLE PUNCHER® – SUB-MIN-D

- For “Sub-Min-D” multiple plug connectors – for sheet steel (S235) and stainless steel
- For punching out the cutout for 9-50-pole plug connectors. Anti-rotation axles for punches and dies are used as draw bolts.
- All hole punches are fitted with side ejection for the waste piece. No jamming in the die
- The hole punches are supplied in heavy duty, practical plastic cases

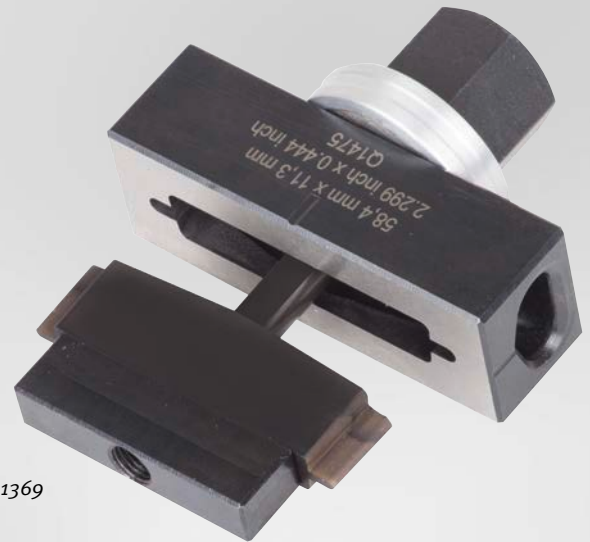

Prod.-No. 01369

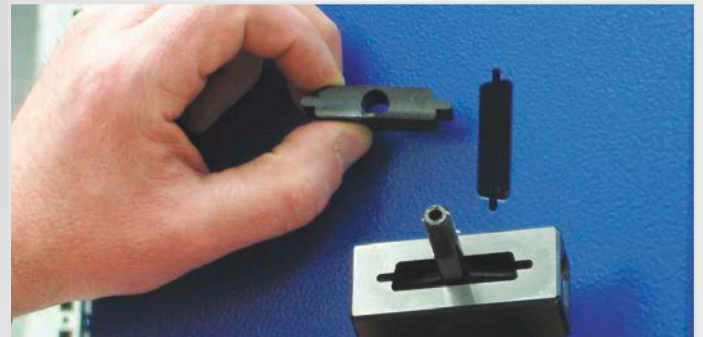
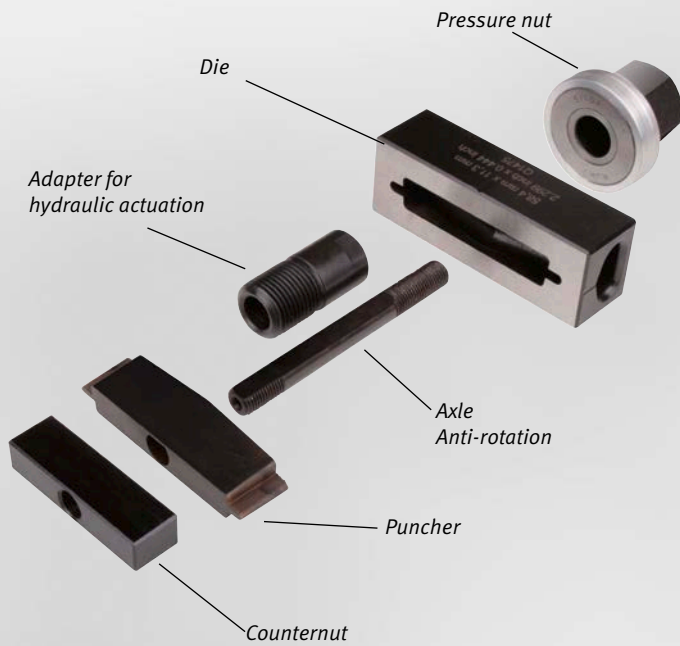

Size in mm	Max. Material thickness in mm (S235)/VA	Number of poles	For use in		pre-drilling in mm	incl. 1 - 4	1 draw bolt	2 counternut or bridge	3 Ball bearing pressure nut	4 Adapter for hydraulic
19.8 x 11.3	2.0/1.5	9-pole	●	●	10					

Hole puncher Sub-Mini-D – rectangular

						Prod.-No.				
19.8 x 11.3	2.0/1.5	9-pole	●	●	10	01366	01438	01442	01352	01353
28.2 x 11.3	2.0/1.5	15-pole	●	●	10	01367		01443		
41.9 x 11.3	1.75/1.25	25-pole	●	●	10	01368		01447		
58.4 x 11.3	1.75/1.25	37-pole	●	●	10	01369		01444		
55.7 x 13.9	1.65/1.0	50-pole	●	●	10	01370		01445		

ALFRA HOLE PUNCHER® – SPECIAL FORMS

- All hole puncher are fitted with side ejection for the waste piece.
No jamming in the die
- The hole puncher are supplied in heavy duty, practical plastic cases



Size in mm	Max. Material thickness in mm (S235)	For use in		pre-drilling in mm	incl. 1 - 4	1 draw bolt	2 counternut or bridge	3 Ball bearing pressure nut	4 Adapter for hydraulic

Hole punches special forms





					Art.-Nr.					
	Ø 22.5 with 3 mm lug	2,0	●	●	14	01420	01333			
	Ø 22.5 2-sided flattened to 18.5 mm	2,0	●	●	14	01421	01351			
	Ø 22.5 4-sided flattened to 20.1 mm	2,0	●	●	14	01422		01347	01352	01353
	33.3 x 17.0 x 10.0 for profile cylinder	2,0	●	●	14	01423				
	Ø 16.3 4-sided flattened to 14.1 mm	1,75	●	●	11	01427	01348	01355		

Hole punches special forms – for stainless steel (VA)

	Ø 22.5 with 3 mm lug	2,0	●	●	14	014201	01333	01351	01352	01353
--	-------------------------	-----	---	---	----	--------	-------	-------	-------	-------

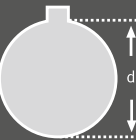

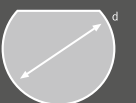

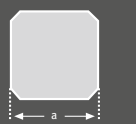
ALFRA HOLE PUNCHER® – CUSTOM-MADE PRODUCTS

- We can make any form of circular, square, rectangular hole puncher to your drawings at short notice
- Please state whether your enquiry is for manual or hydraulic actuation in addition to the sheet thickness and material number
- Ask for our technical support

Hole puncher custom-made products									
 <p>Circular</p>	Ø diameter d				Material thickness		Material type		
	mm				mm		Sheet steel (S235)	<input type="checkbox"/>	
								Stainless steel (VA)	<input type="checkbox"/>
 <p>Circular with lugs</p>	Ø diameter d		Number of lugs	Lug width	Material thickness		Material type		
	mm			mm	mm		Sheet steel (S235)	<input type="checkbox"/>	
								Stainless steel (VA)	<input type="checkbox"/>
 <p>Square</p>	Edge length a				Material thickness		Material type		
	mm				mm		Sheet steel (S235)	<input type="checkbox"/>	
								Stainless steel (VA)	<input type="checkbox"/>
 <p>Rectangle</p>	Width b		Height h		Material thickness		Material type		
	mm		mm		mm		Sheet steel (S235)	<input type="checkbox"/>	
								Stainless steel (VA)	<input type="checkbox"/>
 <p>Circular flattened on one side</p>	Ø diameter d		Flattened to		Material thickness		Material type		
	mm		mm		mm		Sheet steel (S235)	<input type="checkbox"/>	
								Stainless steel (VA)	<input type="checkbox"/>
 <p>Circular flattened on two sides</p>	Ø diameter d		Flattened to		Material thickness		Material type		
	mm		mm		mm		Sheet steel (S235)	<input type="checkbox"/>	
								Stainless steel (VA)	<input type="checkbox"/>
 <p>Square with 4 flattened corners</p>	Edge length a		Corners flattened to		Material thickness		Material type		
	mm		mm		mm		Sheet steel (S235)	<input type="checkbox"/>	
								Stainless steel (VA)	<input type="checkbox"/>

ALFRA HYDRAULIC MANUAL PUNCHERS



	 ALFRA COMPACT®	 ALFRA COMPACTCOMBI®	 ALFRA COMPACT FLEX®	 ALFRA AKKU-COMPACT FLEX®
Page	26 - 27	28 - 29	32	30 - 31
Prod.-No.	02001	02050	02065	02082
Punching Circular holes	up to 82 mm Ø 3.0 mm sheet steel (S235), 2.0 mm stainless steel (F = 600 N/mm ²)			
	89 - 152 mm Ø (with special draw bolt and spacer sleeve) 2.0 mm sheet steel (S235), 1.5 mm stainless steel (F = 600 N/mm ²)			
Punching Shaped holes	68 x 68 mm 3.0 mm sheet steel (S235), 2.0 mm stainless steel (F = 600 N/mm ²)			
	92 x 92 mm (with special draw bolt and spacer sleeve) 2.0 mm sheet steel (S235), 1.5 mm stainless steel (F = 600 N/mm ²)			
Punching force	75 kN	75 kN	75 kN	75 kN
Hydraulic pressure max.	680 bar	680 bar	680 bar	680 bar
Piston stroke	18 mm	18 mm	18 mm	18 mm
Tool mounting	19 mm	19 mm	19 mm	19 mm
Hydraulic hose length	-	-	600 mm	600 mm
Hydraulic medium	HLP32 hydraulic oil	HLP32 hydraulic oil	HLP32 hydraulic oil	HLP32 hydraulic oil
Weight	1.45 kg	1.75 kg	1.97 kg	2.5 kg with Battery

COMPACT® MANUAL PUNCHER STRAIGHT

Compact® manual puncher straight

for use in construction of switch gear and control cabinets – suitable for all hole puncher types.
Loading only takes place in the tension direction and makes work considerably easier.

- 1 Precisely-matched overpressure valve
- 2 Reinforced handle – soft touch
- 3 Body hard-anodised, stable grip, elegant
- 4 Weighs only 1.45 kg
- 5 High-compression cylinder bore surface
- 6 Lasered production code on rear
- 7 High punching force of 75 kN



COMPACT® MANUAL PUNCHER STRAIGHT – SETS



Ø mm	15.2	16.2	18.6	20.4	22.5	25.4	28.3	32.5	37	40.5	47	50.5	54	60	63.5
Ø metric	-	M 16	-	M 20	-	M 25	-	M 32	-	M 40	-	M 50	-	-	M 63
Ø PG	9	-	11	13	16	-	21	-	29	-	36	-	42	48	-
Ø Inch					7/8"	1"							2-1/8"		2-1/2"
	0.598	0.638	0.732	0.803	0.886	1.000	1.114	1.280	1.457	1.594	1.850	1.988	2.126	2.362	2.500

Item no

Set MonoCut® – for sheet steel (S235):

1 Compact® manual puncher straight / MonoCut® punches and dies / 1 draw bolt Ø 19 mm / 1 draw bolt Ø 19 x 9.5 mm / 1 HSS pre-drill Ø 11 mm / 1 spacer sleeve set (3-part)

	02006	•		•	•	•		•		•		•		•	
--	--------------	---	--	---	---	---	--	---	--	---	--	---	--	---	--

Set TriCut® – for sheet steel (S235):

1 Compact® manual puncher straight / TriCut® punches and dies / 1 draw bolt Ø 19 mm / 1 draw bolt Ø 19 x 9.5 mm / 1 HSS pre-drill Ø 10 mm / 1 spacer sleeve set (3-part)

	01752	•		•	•	•		•		•		•		•	•
	01765		•		•		•	•		•					
	01758		•		•		•	•		•		•			•

Set TriCut+® – for sheet steel (S235) and stainless steel sheeting:

1 Compact® manual puncher straight / TriCut® punches and dies / 1 draw bolt Ø 19 mm / 1 draw bolt Ø 19 x 11.1 mm / 1 HSS pre-drill Ø 11.5 mm / 1 spacer sleeve set (3-part)

	01650	•		•	•	•		•		•		•		•	
	01642		•		•		•	•		•					
	01654		•		•		•	•		•		•			•

Set TwinCut® – for sheet steel (S235) and stainless steel sheeting:

1 Compact® manual puncher straight / TwinCut® punches and dies / 1 draw bolt Ø 19 mm / 1 draw bolt Ø 19 x 9.5 mm / 1 draw bolt Ø 19 x 11.1 mm / 1 HSS pre-drill Ø 11.5 mm / 1 spacer sleeve set (3-part)

	01570		•		•		•		•		•				
--	--------------	--	---	--	---	--	---	--	---	--	---	--	--	--	--

Compact® manual puncher straight:

1 Compact® manual puncher straight / 1 draw bolt Ø 19 mm / 1 draw bolt Ø 19 x 9.5 mm / 1 HSS pre-drill Ø 11 mm / 1 spacer sleeve set (3-part)

	02001	without punches and dies													
--	--------------	--------------------------	--	--	--	--	--	--	--	--	--	--	--	--	--

COMPACTCOMBI® MANUAL PUNCHER 90°

CompactCombi® manual puncher 90°

for use in construction of switch gear and control cabinets - suitable for all hole puncher types.
Loading only takes place in the tension direction and makes work considerably easier.

- 1 Precisely-matched overpressure valve
- 2 Reinforced handle – soft touch
- 3 Body hard-anodised, stable grip, elegant
- 4 Weighs only 1.75 kg
- 5 High-compression cylinder bore surface
- 6 Lasered production code on rear
- 7 High punching force of 75 kN



COMPACTCOMBI® MANUAL PUNCHER 90° – SETS



Ø mm	15.2	16.2	18.6	20.4	22.5	25.4	28.3	32.5	37	40.5	47	50.5	54	60	63.5
Ø metric	-	M 16	-	M 20	-	M 25	-	M 32	-	M 40	-	M 50	-	-	M 63
Ø PG	9	-	11	13	16	-	21	-	29	-	36	-	42	48	-
Ø Inch					7/8"	1"							2-1/8"		2-1/2"
	0.598	0.638	0.732	0.803	0.886	1.000	1.114	1.280	1.457	1.594	1.850	1.988	2.126	2.362	2.500

Item no

Set MonoCut® – for sheet steel (S235):

1 CompactCombi® manual puncher 90° / MonoCut® punches and dies / 1 draw bolt Ø 19 mm / 1 draw bolt Ø 19 x 9.5 mm / 1 HSS pre-drill Ø 11 mm / 1 spacer sleeve set (3-part)

	02052	•		•	•	•		•		•		•		•	•
---	--------------	---	--	---	---	---	--	---	--	---	--	---	--	---	---

Set TriCut® – for sheet steel (S235):

1 CompactCombi® manual puncher 90° / TriCut® punches and dies / 1 draw bolt Ø 19 mm / 1 draw bolt Ø 19 x 9.5 mm / 1 HSS pre-drill Ø 10 mm / 1 spacer sleeve set (3-part)

	01753	•		•	•	•		•		•		•		•	•
	01766		•		•		•	•		•					
	01759		•		•		•	•		•		•			•

Set TriCut+® – for sheet steel (S235) and stainless steel sheeting:

1 CompactCombi® manual puncher 90° / TriCut+® punches and dies / 1 draw bolt Ø 19 mm / 1 draw bolt Ø 19 x 11.1 mm / 1 HSS pre-drill Ø 11.5 mm / 1 spacer sleeve set (3-part)

	01651	•		•	•	•		•		•		•		•	
	01643		•		•		•	•		•					
	01655		•		•		•	•		•		•			•

Set TwinCut® – for sheet steel (S235) and stainless steel sheeting:

1 CompactCombi® manual puncher 90° / TwinCut® punches and dies / 1 draw bolt Ø 19 mm / 1 draw bolt Ø 19 x 9.5 mm / 1 draw bolt Ø 19 x 11.1 mm / 1 HSS pre-drill Ø 11.5 mm / 1 spacer sleeve set (3-part)

	01575		•		•		•		•		•				
---	--------------	--	---	--	---	--	---	--	---	--	---	--	--	--	--

CompactCombi® manual puncher 90°:

1 CompactCombi® manual puncher 90° / 1 draw bolt Ø 19 mm / 1 draw bolt Ø 19 x 9.5 mm / 1 HSS pre-drill Ø 11 mm / 1 spacer sleeve set (3-part)

	02050	without punches and dies													
---	--------------	--------------------------	--	--	--	--	--	--	--	--	--	--	--	--	--

AKKU-COMPACT FLEX®

Akku-Compact Flex®

for use in construction of switch gear and control cabinets – suitable for all hole puncher types. Loading only takes place in the tension direction and makes work considerably easier.



- 1 Handle inset soft touch
- 2 High-pressure hose – flexible, elastic
- 3 USB interface for readable pressure values, service intervals etc...
- 4 Pressure sensor – automatic detection of puncher breakthrough. Once the material has been punched through, the puncher can not damage the die



AKKU-COMPACT FLEX®

Practical manual hydraulics with 18 V LiON battery for punching circular, square and rectangular cutouts in control cabinet and switch gear construction. Extremely easy to handle and light thanks to high-tensile aluminium head.

- Light and easy to handle, only 2.5 kg including battery

Technical data:

Drive

Max. punching force: 75 kN
Max. hydraulic pressure: 680 bar

Battery

18 V Li-Ion / 1.5 Ah
Charging time: 30 mins. after full discharge
Use: -10° - +40° C

Battery charger

Charges all batteries 18-28 V, compatible for NiCD, NiMH and Li-Ion batteries. Automatic temperature monitoring. Battery cell overcharging is prevented by switchover from rapid charging to trickle charging. The charging state is shown by the LED display. The PCB is completely enclosed.

Punching capacity with 1.5 Ah battery

195 x Ø 22.5 mm MonoCut® to 2.5 mm S235
165 x Ø 22.5 mm TriCut® to 2.5 mm S235

105 x Ø 63.5 mm MonoCut® to 2.5 mm S235
65 x Ø 63.5 mm TriCut® to 2.5 mm S235

170 x Ø 22.5 mm TwinCut® to 1.5 mm V2A
95 x Ø 63.5 mm TwinCut® to 1.5 mm V2A

Weight

2.5 kg including battery



Prod.-No. 02082



Prod.-No. 02072



Prod.-No. 02071

Scope of delivery:

ALFRA Akku-Compact Flex® manual hydraulics
with 1 battery 18 V, charger 18 - 28 V
Draw bolts – 9.5 x 19 mm – Prod.-No. 02003
Draw bolts – 19 x 120 mm – Prod.-No. 02002
Spacer sleeve set 3-part – Prod.-No. 02004
Pre-drill 11 mm Ø – Prod.-No. 08023
in heavy duty, practical plastic case

Prod.-No.

02082

Spare parts:

Replacement battery
Battery charger 220 V - 240 V
* Special draw bolt for square holes 92 x 92 mm
* Special draw bolt for round holes 89 - 152 mm
* Special spacer sleeve

Prod.-No.

02082-01

02082-03

01395

01398L

01396

COMPACT FLEX® HAND HYDRAULICS

Compact Flex® manual hydraulics

for use in construction of switch gear and control cabinets – suitable for all hole puncher types.
Loading only takes place in the tension direction and makes work considerably easier.

- 1 Precisely-matched overpressure valve
- 2 Reinforced handle – soft touch
- 3 Body hard-anodised, stable grip, elegant
- 4 Weighs only 2 kg
- 5 High-compression cylinder bore surface
- 6 Lasered production code on rear
- 7 High punching force of 75 kN
- 8 High-pressure hose flexible – elastic

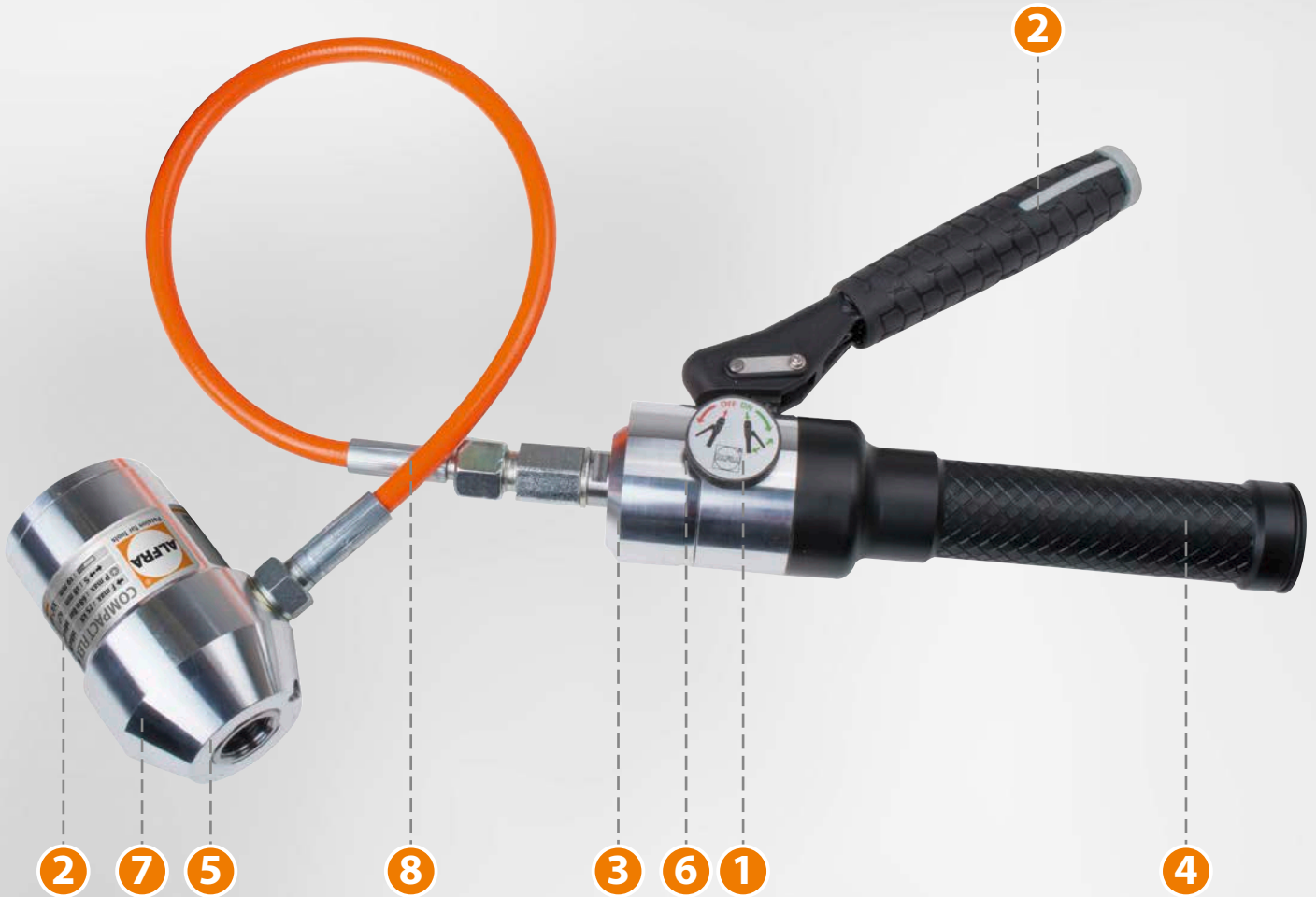

Punching capacity

Punching force:	75 kN
Operating pressure max.:	680 bar
Hydraulic hose length:	600 mm
Weight:	2.0 kg

Scope of delivery:

- 1 Compact Flex® manual hydraulic punch
- 1 draw bolt Ø 19.0
- 1 draw bolt Ø 19.0 x 9.5 mm
- 1 HSS pre-drill Ø 11.0 mm
- 1 spacer sleeve set 3-part

Compact Flex® manual hydraulics
in heavy duty, practical plastic case

Prod.-No.
02065

PUMP SUMMARY

Recommended combination  Possible combination 	 AHP-M1 Prod.-No. 03855	 AHP-S Prod.-No. 03854	 DSP-120 Prod.-No. 02027	 LHP 700 Prod.-No. 02140	 FOOT PUMP Prod.-No. 02121
  Prod.-No. 02012 / 02013	 *				
 Prod.-No. 03200SET					
 Prod.-No. 03250	 *				
 Prod.-No. 03256	 *				
 Prod.-No. 03258	 *				
 Prod.-No. 03300	 *				
 Prod.-No. 03360/03380	 *				
 AP 250					
 AP 400					

* in combination with optional footswitch/hand switch

ALFRA ELECTRO-HYDRAULIC PUMP AHP S

Technical data:

Max. pressure:	700 bar
Max. flow rate:	0.58 l/min
Oil type:	HLP 32
Filling volume:	3.2 l
Working volume:	2.2 l
Weight:	27 kg
Voltage / frequency:	230 V / 50 Hz
Power:	0.75 kW
Current consumption:	3.26 A
Motor speed:	2,800 rpm



Prod.-No.

Electro-hydraulic pump AHP S
incl. hand switch

03854

Optional foot switch 2-pedal

03866

ALFRA ELECTRO-HYDRAULIC PUMP AHP M1



Technical data:

Max. pressure:	700 bar
Max. flow rate:	1.1 l/min
Oil type:	HLP 32
Filling volume:	3.2 l
Working volume:	2.2 l
Weight:	29 kg
Operating voltage:	230 V / 50 Hz
Power:	1.3 kW
Current consumption:	5.65 A
Motor speed:	2,800 rpm

Prod.-No.

Electro-hydraulic pump AHP M1

03855

Optional hand switch for AHP S and AHP M1

03859

Optional foot switch 2-pedal

03866



Prod.-No. 03859 optional

ALFRA FOOT PUMP

- Max. operating pressure 700 bar
- Fitted pressure limiting valve
- For all circular, square, rectangular and special shape hole punches
- The foot pump leaves both hands free for precise positioning and punching on the control cabinet. The foot pump carrying frame is splayed. This guarantees steady working with no risk of tipping

Tank volume: 270 cm³
Usable oil volume: 210 cm³
Delivery volume: 1.7 cm³ per piston stroke

Contents: 1 hydraulic cylinder with quick coupling
1 hydraulic hose 2.8 m
1 draw bolt Ø 19.0 and 19.0 x 9.5 mm
1 spacer sleeve set 5-part
1 pre-drill Ø 11.0 mm

	Prod.-No.
Set foot pump with hydraulic cylinder and accessories	02120
Foot pump only, with 2.8 m hydraulic hose	02121



Prod.-No. 02120



ALFRA ELECTRO-HYDRAULIC PUMP DSP-120

Compact electro-hydraulic pump, two-stage operation withholding function for single-action hydraulic cylinder.

Technical data

Operating voltage:	230 V/50 Hz
Motor power:	0.4 kW
max. operating pressure:	700 bar
Flow rate 0 - 20 bar:	2.0 l/min
Flow rate 20 - 700 bar:	0.2 l/min
Tank volume:	1.2 l
Usable oil volume:	0.8 l
Weight approx.:	7.5 kg

Prod.-No.

Electro-hydraulic pump with accessories

02025

Contents: 1 hydraulic cylinder SKP-1
1 hydraulic hose 1.8 m
1 draw bolt Ø 19.0 and 19.0 x 9.5 mm
1 spacer sleeve set multi-part
1 pre-drill Ø 11.0 mm
1 hand switch

Electro-hydraulic pump only, 220 V, with 1.8 m
hydraulic hose, quick coupling and hand switch

02027

Foot switch 2-pedal

02029

Hand switch

02030



Prod.-No. 02025

ALFRA AIR-HYDRAULIC PUMP – LHP 700

Air-hydraulic pump for the operation of single-action hydraulic cylinders for whole punchers, cable cutters, presses or similar applications.

- Heavy-duty tank
- Tank venting filter
- Reduced noise levels
- Oil level indicator on tank
- Precise start-up under load possible
- Precise activation - the drain valve activated by the foot pedal allows precise lowering of the load.
- Hydraulic hose 2.0 m with quick coupling

Technical data

max. operating pressure: (at a feed line pressure of 7 bar)	700 bar
Feed pressure/working range:	2.8 - 10 bar
Air connection:	1/4" thread
Flow rate depressurised:	1.0 l/min
Flow rate p max. (with 7 bar air):	0.1 l/min
Tank volume:	2.4 l
Usable oil volume:	2.1 l
Weight:	6.3 kg

Prod.-No.

Air-hydraulic pump

02140



Prod.-No. 02140

ACCESSORY PARTS – DRAW BOLTS, BALL BEARING SCREWS

	Size in inch	Size in mm	Prod.-No.
Draw bolt	-	6.0	02024
Adapter	-	19.0 / 6.0	02023
Draw bolt cpl.	-	19.0 / 6.0	02022
Draw bolt	3/8"	9.5	02009
Adapter	3/4" / 3/8"	19.0 / 9.5	01353
Draw bolt compl.	3/4" / 3/8"	19.0 / 9.5	02003
Draw bolt	3/4" / 3/8"	19.0 / 9.5*	02010
Draw bolt	7/16"	11.1	01424
Adapter	3/4" / 7/16"	19.0 / 11.1	01425
Draw bolt compl.	3/4" / 7/16"	19.0 / 11.1	02007
Draw bolt	3/4" / 7/16"	19.0 / 11.1*	02011
Draw bolt	3/4"	19.0	02002

* draw bolts made of high-alloy tool steel for higher loading



	Ø x l in inch	Ø x l in mm	Prod.-No.
Draw bolt with ball bearing	-	6.0 x 46 mm	01334
Draw bolt with ball bearing	3/8" x 2"	9.5 x 50 mm	01339
Draw bolt with ball bearing	3/4" x 2-3/16"	19.0 x 55 mm	01340
Draw bolt with ball bearing	7/16" x 2-3/8"	11.1 x 60 mm	01342
Draw bolt with ball bearing	3/4" x 2-15/16"	19.0 x 75 mm	01341



- 1 High-tensile bolts for the toughest operating conditions
- 2 Protrusion of ball bearing outside protective ring ensures perfect force transmission to wrench or punching tool
- 3 Ballbearings encapsulated in aluminium rings. Extremely long-life and perfectly protected against soiling
- 4 UNF fine thread



ACCESSORY PARTS – FOR HYDRAULIC PUMPS

Prod.-No.

Hydraulic hose for foot pump	2.80 m	02122
Hydraulic hose for LHP 700	2.00 m	02112
Hydraulic hose for DSP 120	2.50 m	02026
Hydraulic hose for AHP S and AHP M	2.00 m	02116



Prod.-No. 02112

HYDRAULIC CYLINDERS AND ACCESSORIES

Prod.-No.

Hydraulic cylinder SKP-1 with quick coupling (up to 11 t)	02012
Weight 2.5 kg	
Hydraulic cylinder SKP-1 Mini with quick coupling (up to 7 t)	02013
Weight 0.86 kg	
Spacer sleeve set 3-part	02004
Spacer sleeve set 5-part	02014
Pre-drill Ø 10.0 mm	08036
Pre-drill Ø 11.0 mm	08023
Pre-drill Ø 11.5 mm	08035
Pre-drill SVB with 5 drill Ø 8.5/11.5/12.5/16.5/21.0 mm	08016



Prod.-No. 02013



Prod.-No. 02014



Prod.-No. 08023



Prod.-No. 08016



Prod.-No. 02012

QUICK-CONNECT COUPLINGS – FOR ALFRA HYDRAULIC EQUIPMENT

- Non-drip coupling and decoupling
- Easy-to-use operability
- Dust protection cap

	Prod.-No.
Connection coupling with internal thread R 1/4" (for fitting to hose end)	01452
Connection coupling with internal thread R 3/8" (for fitting to hose end)	014523/8NPT
Connection nipple with internal thread R 1/4" (for fitting to cylinder)	01453
Adapter R 1/4" external thread	01454



Prod.-No. 01453

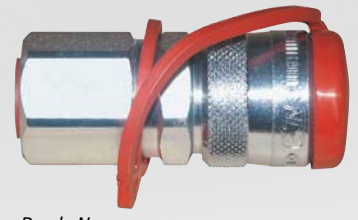

Prod.-No. 01452

ALFRA – SPECIAL METAL LUBRICATING PASTE

Application areas:

- Prevents seizing up, wear, cold-welding, solidifying and fretting corrosion on threads of screws, nuts, bolts, tube threads and fittings.
- ALFRA special metal lubricating paste is also particularly suitable for the lubrication of cutting points on punching tools and high-loading bearings and sliding surfaces.
- Release-active and silicone-free.
- Contents: 120 g

	Prod.-No.
ALFRA special metal lubricating paste	33005

Completely recommended for the use of hole punchers using wrenches.



Prod.-No. 33005

ALFRA – NOTCHING PLIERS

- Punchers notched grooves in sheet steel up to 2.0 mm thick simply and quickly (S235)
- Saves time-consuming filing of grooves for non-twist securing of pushbuttons, switches and instruments
- Notched grooves possible in sizes of 3.2 mm and 4.8 mm
- Easy punching due to large lever arm
- Plastic-coated handle
- Weight 1.3 kg

The notched groove puncher is introduced to the pre-punched opening, aligned to the crosshair markings and then the notched groove tongue is actuated. Your clean groove is finished!

	Prod.-No.
ALFRA notching pliers	03015



Prod.-No. 03015

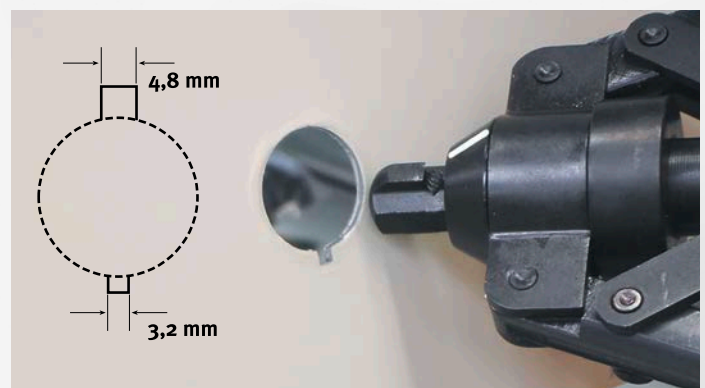

ALFRA CUTTING DEVICES



FOR MOUNTING RAILS

- **Handle: reinforced – soft touch**
- **Limit stop with mm/inch laser-engraved**
- **Burr-free, precise 90° cuts**
- **Lowest-possible cutting play**



ALFRA PROFILE RAIL CUTTING DEVICE® – PSG DUO®



1

- 1 Handle: reinforced – soft touch
- 2 Limit stop with mm/inch laser-engraved
- 3 2 separate profiles for burr-free precise 90° cuts - stable profile guiding
- 4 Profile throughput is optimised for lowest-possible cutting play

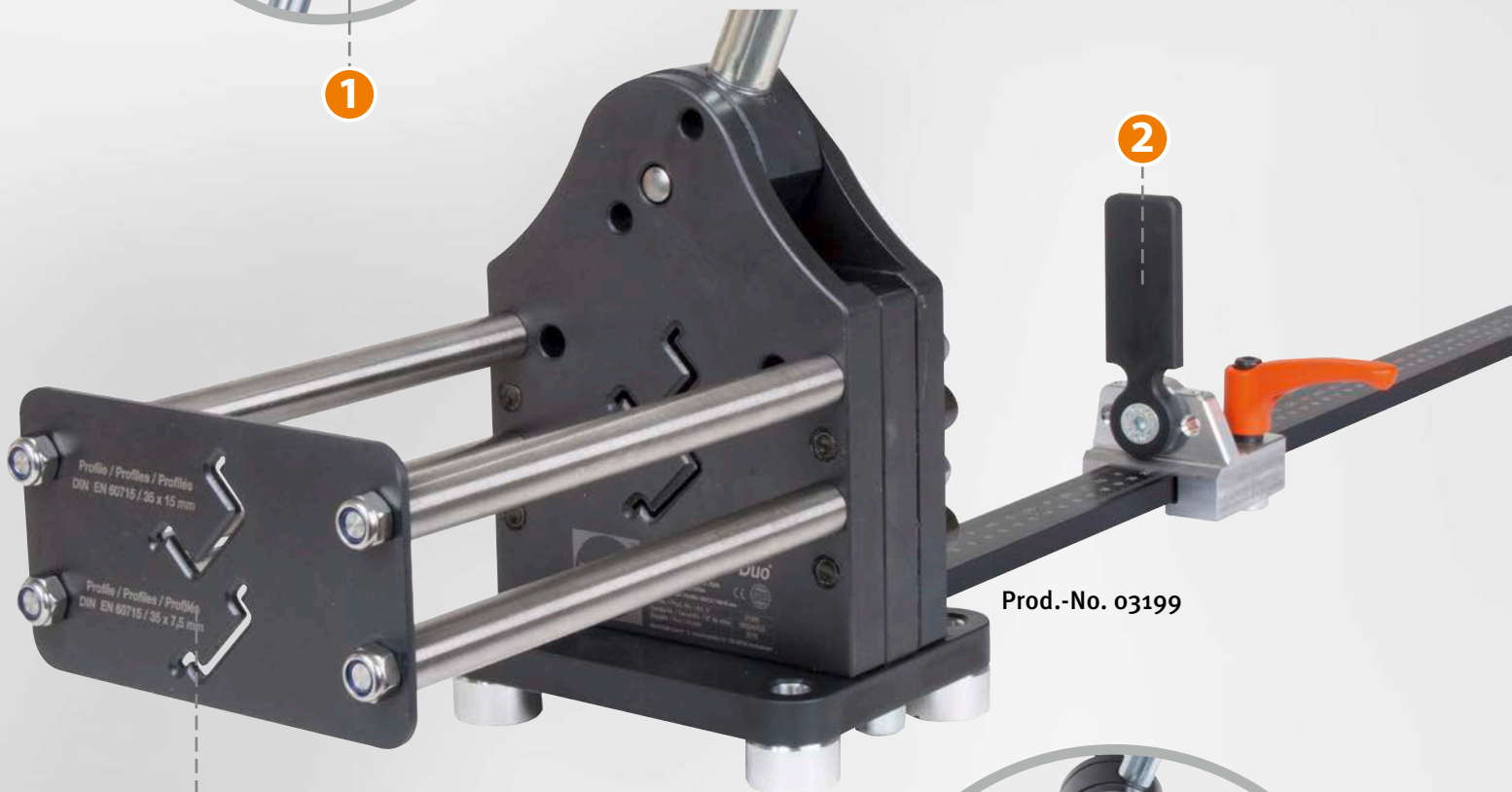

2

Prod.-No. 03199

3



4

ALFRA PROFILE RAIL CUTTING DEVICE® – PSG DUO®

For common mounting rails with hand lever operation

Cuts both profile rails TS 35/7.5 + 35/15 mm precisely and without effort

- With guide support for 90°-angle precise cutting
- With reinforced cam located directly above the shear plate
- Lower force application due to improved force transmission
- Maintenance-free
- Cutting to length without waste
- Shear plate re-grindable
- Anodised, laser-engraved longitudinal limit stop 1000 mm with guidance fixture for precise angled cutting to length with millimetre and inch scaling.
- Easy to install on the workbench
- Scale divisions metric and inches

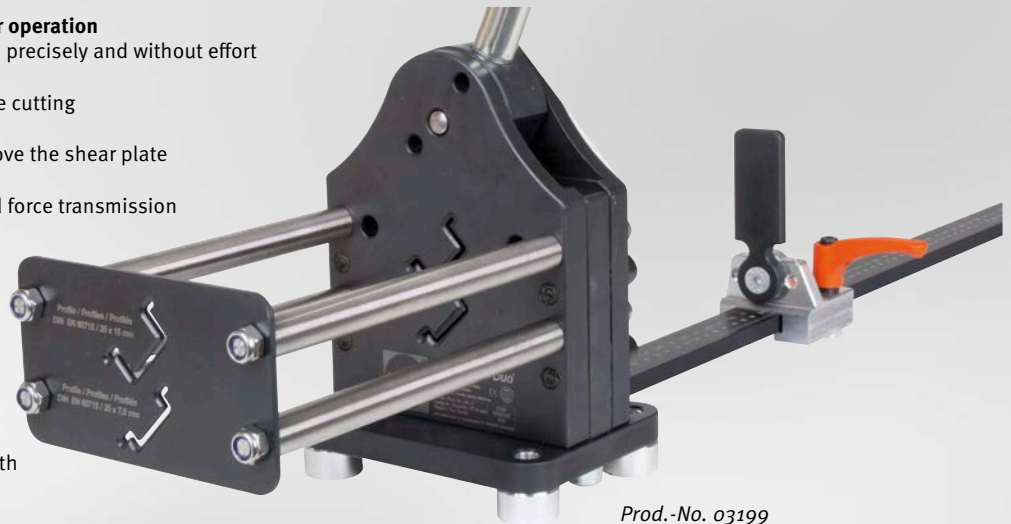

Prod.-No. 03199

ALFRA profile rail cutting device® – PSG Duo®

Prod.-No.
03199

Profile rails

Mounting rail
35 mm/7.5
as per EN 60715

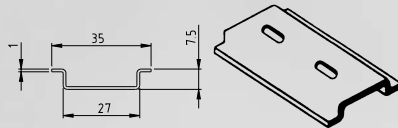

Mounting rail
35 mm/15
as per EN 60715

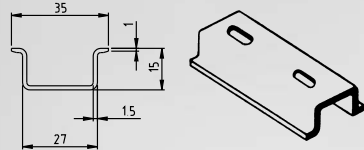

Custom-made products for special profiles such as cable ducting on request!



ALFRA PROFILE RAIL CUTTING DEVICE® – PSG 4®



1

- 1 Handle: reinforced - soft touch
- 2 Limit stop with mm/inch laser-engraved
- 3 Profile throughput is optimised for lowest-possible cutting play



2

Prod.-No. 03004



3

ALFRA PROFILE RAIL CUTTING DEVICE® – PSG 4®

For hand-operated mounting rails

Cuts profile and ground rails precisely and without effort.
Standard version for TS 35/7.5 - 35/15 - 15/5.5 - Cu 10.0 x 3.0 mm

- With reinforced cam located directly above the shear plate
- Lower force application due to improved force transmission
- Burr-free cutting to length without waste
- Maintenance-free
- Anodised, laser-engraved length limit stop 1,000 mm with guiding device for precise angled cutting to length, with millimetre and inch scaling
- Shear plate re-grindable
- Guidance fixture for 90° angle-precise cutting
- Easy to install on the workbench
- Custom-made products are also possible (please send us a sample rail of about 1,000 mm length)

ALFRA profile rail cutting device® – PSG 4®

Prod.-No.
03004



Guidance fixture
for 90° angle-precise cutting

Standard version

Mounting rail
35 mm/7.5
as per EN 60715

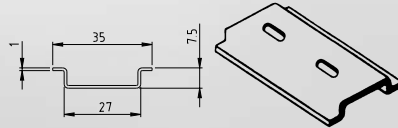

Mounting rail
35 mm/15
as per EN 60715

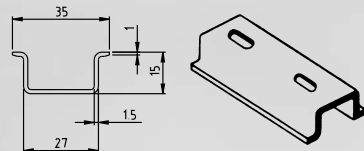

Mounting rail
15 mm/5.5
as per EN 60715

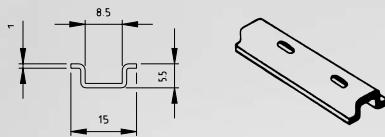

Copper ground rails
10 mm x 3 mm

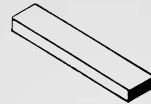

Prod.-No. 03004

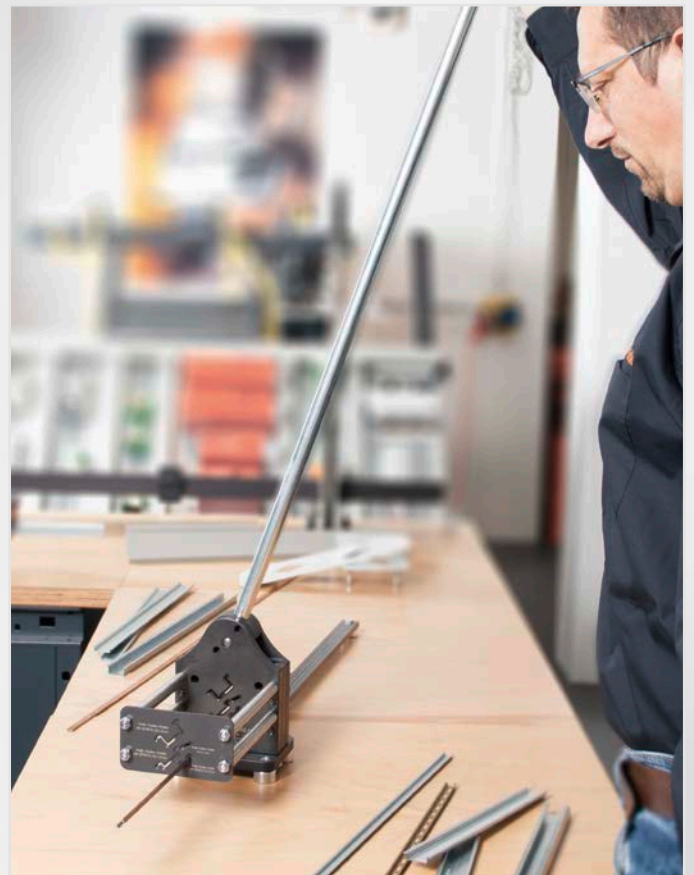

ALFRA PROFILE RAIL CUTTING DEVICE[®] – PSG 5+[®]



1

- 1 Handle: reinforced – soft touch
- 2 Limit stop with mm/inch laser-engraved compatible with PSG series
- 3 Profile throughput is optimised for lowest-possible cutting play

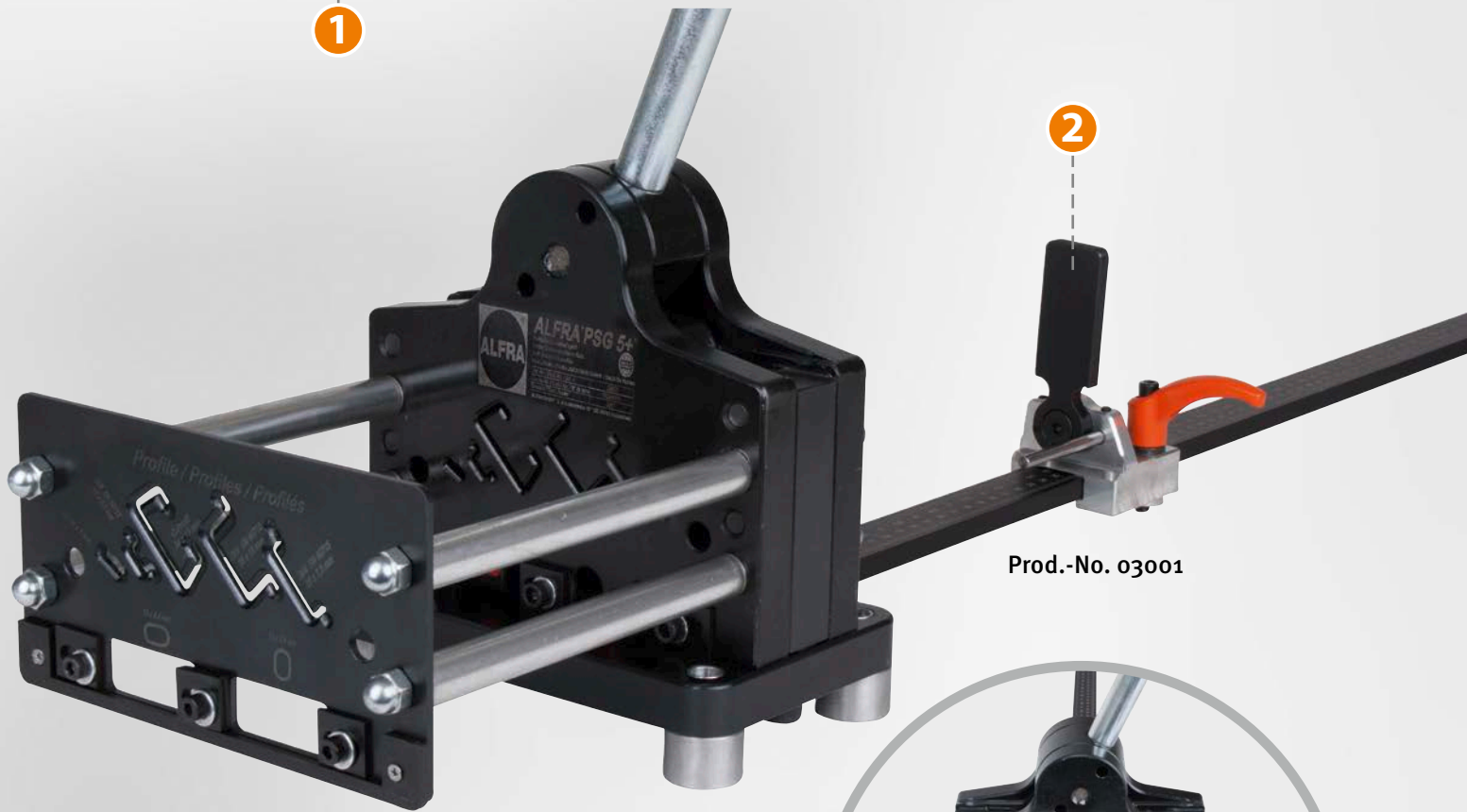

2

Prod.-No. 03001



3

ALFRA PROFILE RAIL CUTTING DEVICE® – PSG 5+®

For mounting rails, for hand lever operation for **cutting to length and hole punching longitudinally and transversely** on the depicted mounting rails.

- With reinforced cam located directly above the shear plate
- Lower force application due to improved force transmission
- Burr-free cutting to length without waste
- Maintenance-free
- Anodised, laser-engraved length limit stop 1,000 mm with guiding device for precise angled cutting to length, with millimetre and inch scaling
- Shear plate can be re-ground, puncher replaceable
- Custom-made products are also possible (please send us a sample rail of about 1,000 mm length)



Prod.-No. 03001

Scope of delivery standard version

	Prod.-No.
with transverse and longitudinal hole puncher 12 x 6.4 mm, 1000 mm length limit stop and guidance fixture incl. C-profile 3415	03001
with transverse and longitudinal hole puncher 12 x 6.4 mm, 1000 mm length limit stop and guidance fixture incl. G-profile as per EN 60715	03001G
as 03001, however with round hole puncher Ø 5.5 or 6.0 mm	03002
as 03001, however with hydraulic cylinder	03003

Tool for fixing holes (longitudinal and transverse) integrated. Guidance fixture for 90° angle-precise cutting

Standard version

Mounting rail
35mm/7.5
as per EN 60715

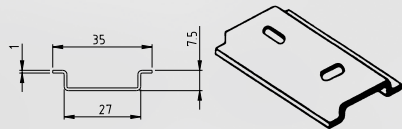

Mounting rail
35 mm/15
as per EN 60715

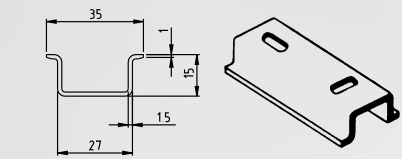

Mounting rail
15 mm/5.5
as per EN 60715

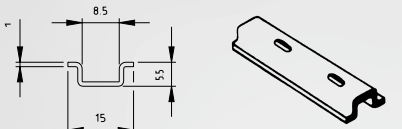

C-profile 3415
(included in Prod.-No. 03001)



G-profile
as per EN 60715
(included in Prod.-No. 03001G)

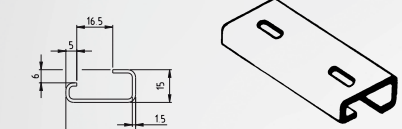

Copper ground rails
10 mm x 3 mm

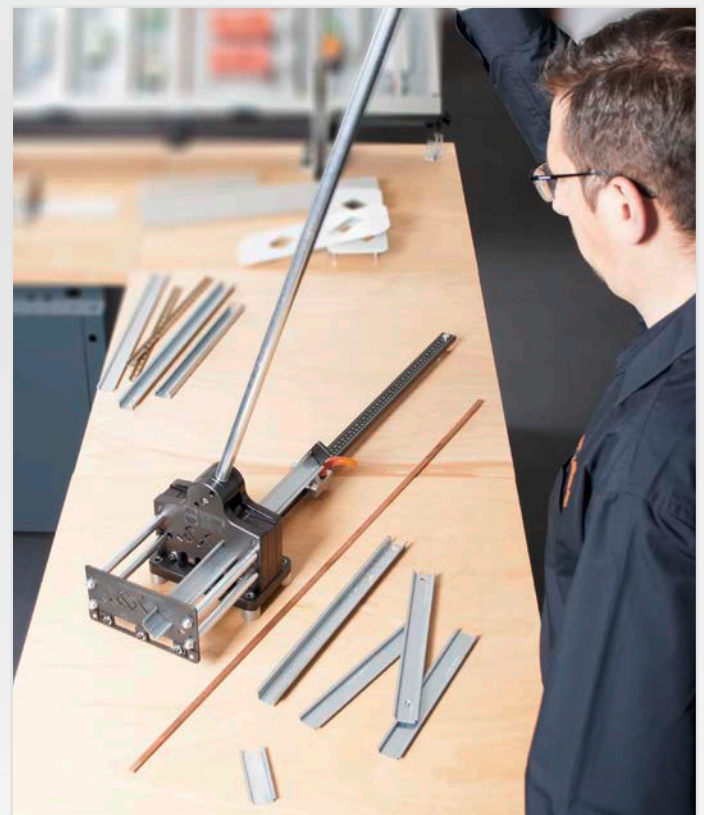
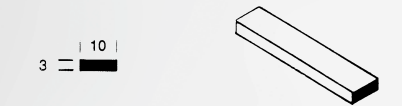

Spare parts for universal cutting and punching device

	Prod.-No.
Spare puncher + die 12 x 6.4 mm f. longitudinal hole	03005
Spare puncher + die 12 x 6.4 mm f. transverse hole	03006
Spare puncher + die 5.5 mm f. round hole	03007
Spare puncher + 6.0 mm f. round hole	03008
Special versions for mounting rails or flat rails, also in stainless steel or aluminium or plastic on request	03011



Prod.-No. 03003

We recommend our pump type AHP 5 (Prod.-No. 03854) as a drive

ALFRA CABLE DUCTING CUTTING DEVICE – VKS 125



ALFRA CABLE DUCT CUTTING DEVICE – VKS 125

ALFRA cable duct cutting device – VKS 125

Cuts cable ducting and covers up to 125 mm wide in seconds precisely and without effort. Fixing tabs for easy fitting to the Workbench are attached to the device and to the longitudinal limit stop.

The VKS 125 is fitted with a sprung cutter protector which covers the cutter when it is not being used.

- Burr-free cutting to length without waste
- 90° angle-precise cutting
- Maintenance-free
- Easy to install on the workbench

“...no more plastic swarf and no more deburring!”

ALFRA VKS 125
Cutter for VKS 125

Prod.-No.
031920
03192

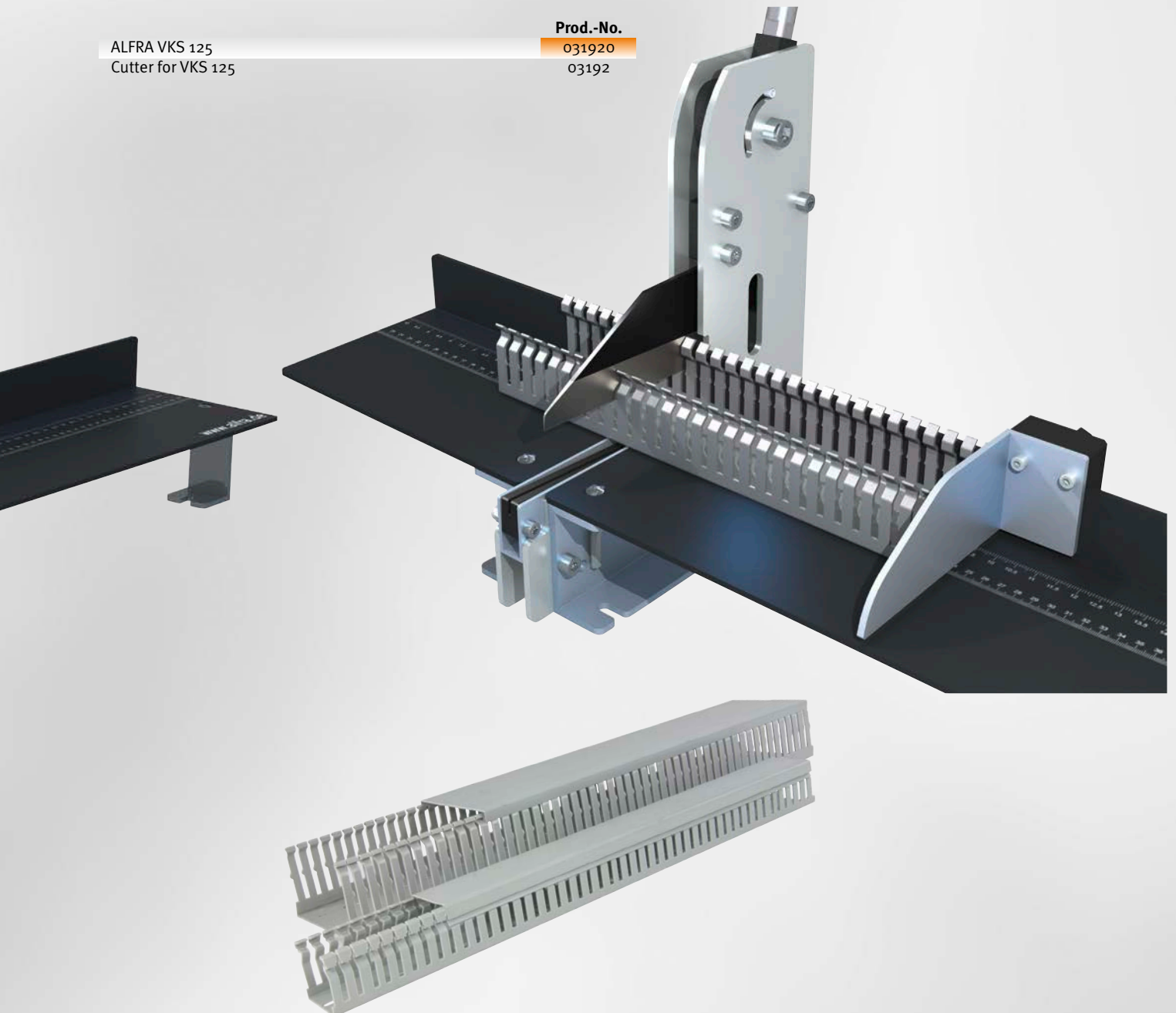

ALFRA ASSEMBLY TABLE



Simply put together your desired assembly table with its accessories on our website and then request a quotation by clicking:
www.schaltschrank123.de/en

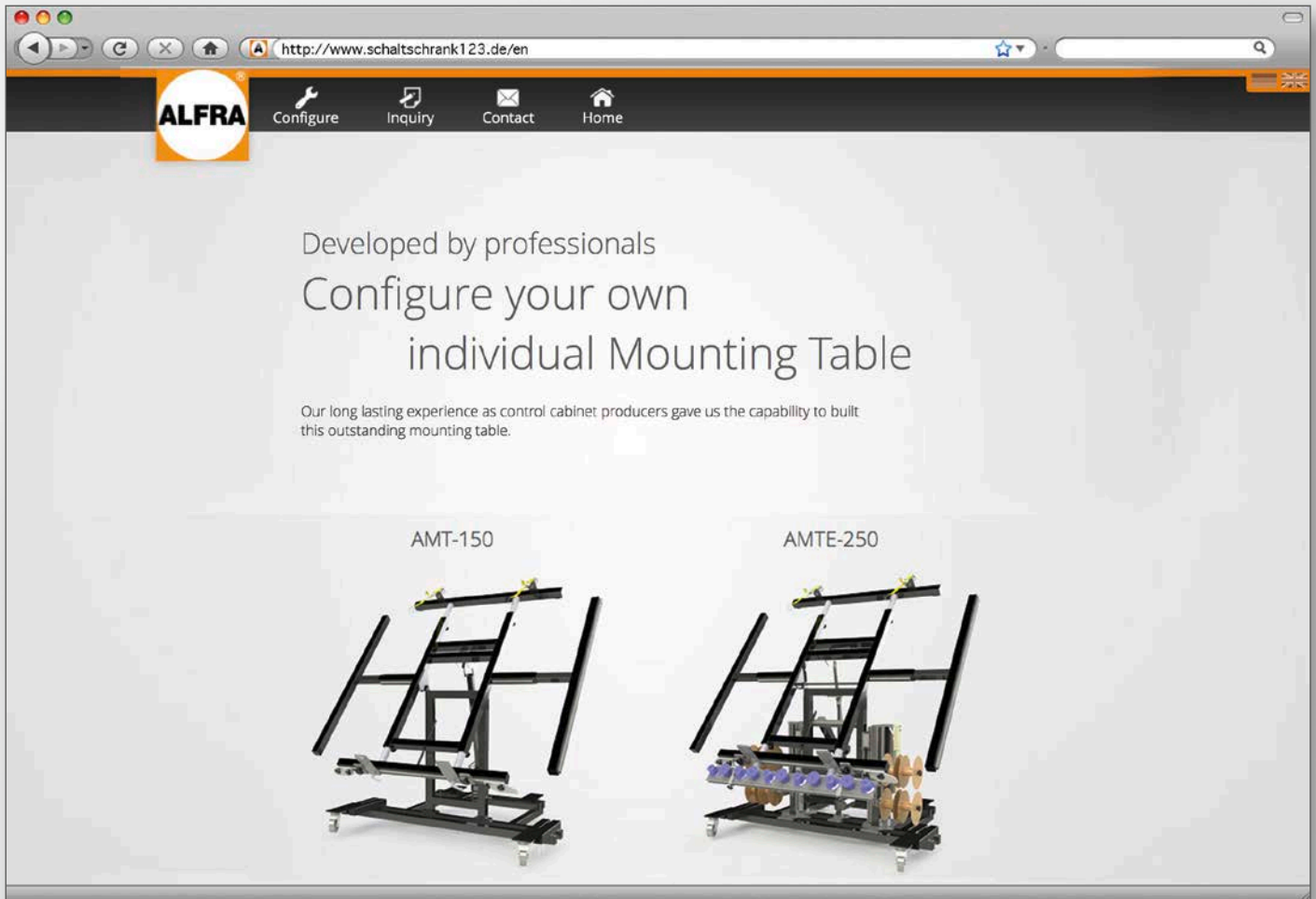

ALFRA ASSEMBLY TABLE AMT 150



AMT 150

Prod.-No.	03100
Simple, variable fixing of mounting panels using quick-action clamp.	✓
Intelligent release system enables unrestricted processing of the entire mounting panel	✓
Infinitely variable adjustment from vertical to horizontal	using handcrank or battery drill
Infinitely variable height adjustment	via angle of inclination
Electric motor	-
Battery-operated	-
Adjustable angle of inclination	0 - 80°
Working height	fixed: 100 cm
4 guide rollers with total fixing	✓
Max. size mounting panels W x H	1,100 x 1,900 mm
Max. useful load	200 kg
Space requirement	1,400 x 1,200 mm
Weight	83 kg
Scope of delivery	Assembly table AMT 150 2 x clamping unit with bolt 2 x clamping unit with quick lock Screw adapter for operating with battery drill

OPTIONS FOR ALL AMTs



EXTENSION SET
Table width extension for horizontal support of mounting panels
Prod.-No. 03100-001



CLAMPING UNIT WITH QUICK LOCK
Prod.-No. 03100-003



CLAMPING UNIT WITH BOLT
Prod.-No. 03100-002

OPTION FOR AMT 150

SCREW ADAPTER AMT 150
for operation with battery drill
Prod.-No. 03100-004

ALFRA ELECTRIC ASSEMBLY TABLE AMTE 250



AMTE 250

031001



using battery-operated electric motors

using battery-operated electric motors



0 - 80°

variable: 80 - 110 cm



1,100 x 1,900 mm

300 kg

1,400 x 1,200 mm

140 kg

Electric assembly table AMTE 250
2 x clamping unit with bolt
2 x clamping unit with quick lock
external charging station for the battery

OPTIONS FOR ALL AMTs



CONTROL CABINET SET
Prod.-No. 03100-005

OPTIONS FOR AMTE 250



CABLE GUIDANCE
Prod.-No. 031001-003



CABLE ROLL HOLDER
Prod.-No. 031001-002

OPTION FOR AMTE 250



ROLLER CONVEYOR
for sideways insertion of the mounting panel
into the control cabinet
Prod.-No. 031001-004

OPTIONS FOR AMTE 250

SPARE BATTERY
Prod.-No. 031001-001

CHARGING PLUG
for 110 V 60 Hz
Prod.-No. 031001-0011

ALFRA BUSBAR MACHINING



ALFRA BUSBAR BENDING AND HOLE PUNCHING DEVICE

Busbars at 120 x 12 mm (160 x 10 mm on request) can easily be bent using a universal working cylinder, and holes of Ø 6.6 up to 21.5 mm including longitudinal holes can be punched through the simple insertion of hole punchers.



Bending busbars

Turn switch to “bend”

To bend busbars, the bending die is inserted in the hydraulic piston and the electric angle measurer is placed in the round guidance crew on the counter block. The contact cable is connected to the electric motor. The required angle is fixed on the angle scale using an adjusting screw.

Since copper springs back, we recommend making a setting 1° - 3° above the required angle depending on the material thickness.

You should check the first bending angle. This bending angle can be reproduced as often as required since the bending process is automatically interrupted on achieving the angle by the electrical contact switch.

Technical data Bending

Bending Cu max:	120 x 12 mm
Bending up to:	more than 90°
smallest leg length:	50 mm
smallest U-bend:	100 mm
smallest Z-bend:	72 mm (depending on material thickness)

The values stated are based on copper rails 120 x 10 mm



Punching busbars

Switch setting to “punch”

The puncher with the neoprene scraper and the matching die are placed in the locating hole.

The puncher is fixed sideways using a grub screw. Depending on the busbar width and the required hole arrangement, the processing block can be infinitely variably raised or lowered hydraulically using the handwheel. A counter attached to the handwheel shows the height of the hole centre in millimetres.

We recommend centre-punching the busbar and then aligning the puncher centring point above the centre puncher to guarantee a precise hole location.

The neoprene scraper and a fitted electronic sensor ensure automatic puncher retraction.

Technical data Punching

Punching Cu:	6.6 - 21.5 mm also longitudinal hole up to max. L = 21 mm
Material thickness Cu max:	12 mm
Material width up to:	110 mm central
External dimensions L x W x H:	700 x 410 x 410 mm
Weight:	60 kg

Special version for processing of busbars up to 160 x 10 mm available on request.

ALFRA BUSBAR BENDING AND HOLE PUNCHING DEVICE

	Prod.-No.
ALFRA busbar bending and hole punching device with electrical angle measurer R10, bending die R10 and length limit stop	03200SET
Electrical angle measurer R10	03201
Bending die R10	03202
Length limit stop	03203
Bending die with movable jaws (120 x 10 mm Cu)	03228
Stage bending tool with 2 pairs of pressure plates for 5 and 10 mm stages (max. range: 100 x 5 mm / 60 x 10 mm Cu)	03246
Footswitch with START – STOP – OFF (direct connection to basic device 03200)	03865



Prod.-No. 03200SET



Prod.-No. 03201



Prod.-No. 03202



Prod.-No. 03228

Electro-hydraulic pump AHP M1

Technical data:

Max. pressure:	700 bar
Max. flow rate:	1.1 l/min
Oil type:	HLP 32
Filling volume:	3.2 l
Working volume:	2.2 l
Weight:	29 kg
Operating voltage:	230 V / 50 Hz
Power:	1.3 kW
Current consumption:	5.65 A
Motor speed:	2800 rpm

	Prod.-No.
Electro-hydraulic pump AHP M1	03855
Optional hand switch for AHP S and AHP M1	03859
Optional foot switch 2-pedal	03866
Footswitch with START – STOP – OFF (direct connection to hydraulic pump 03855)	03863



Prod.-No. 03855

Electro-hydraulic pump AHP S

Technical data:

Max. pressure:	700 bar
Max. flow rate:	0.58 l/min
Oil type:	HLP 32
Filling volume:	3.2 l
Working volume:	2.2 l
Weight:	27 kg
Voltage / frequency:	230 V / 50 Hz
Power:	0.75 kW
Current consumption:	3.26 A
Motor speed:	2800 rpm

	Prod.-No.
Electro-hydraulic pump AHP S incl. hand switch	03854
Optional foot switch 2-pedal	03866



Prod.-No. 03854

ALFRA BUSBAR BENDING AND HOLE PUNCHING DEVICE

ALFRA busbar set 1:

Prod.-No.
03911

- Prod.-No. 03200SET
ALFRA busbar bending and hole punching device with electrical angle measurer R10, bending die R10 and length limit stop
- Prod.-No. 03855
electro-hydraulic pump **AHP M1**



ALFRA busbar set 2:

Prod.-No.
03921

- Prod.-No. 03200SET
ALFRA busbar bending and hole punching device with electrical angle measurer R10, bending die R10 and length limit stop
- Prod.-No. 03854
electro-hydraulic pump **AHP S**



Accessories

Available punches and dies

Punch Ø in mm	Metric Screw connection	Max. Material thickness in mm	Prod.-No.
6.6	6.0	5.0	03204
9.0	8.0	6.0	03205
9.5	8.0	6.0	03206
11.0	10.0	12.0	03207
11.5	10.0	12.0	03208
13.5	12.0	12.0	03209
14.0	12.0	12.0	03210
17.5	16.0	12.0	03211
18.0	16.0	12.0	03212
21.0	20.0	12.0	03213
21.5	20.0	12.0	03214



Prod.-No. 03921

Die Ø Max. in mm	Material thickness in mm	Prod.-No.
6.6	5.0	03230
9.0	6.0	03231
9.5	6.0	03232
11.0	12.0	03233
11.5	12.0	03234
13.5	12.0	03235
14.0	12.0	03236
17.5	12.0	03237
18.0	12.0	03238
21.0	12.0	03239
21.5	12.0	03240

Punches and dies for longitudinal holes up to max. L x W = 21 x 18 mm upon request
Prod.-No. 03241

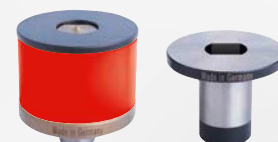

longitudinal hole punches and dies

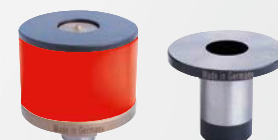

Round punches and dies

ALFRA BUSBAR CUTTING DEVICE – S 125

**For clean, burr-free cutting of copper busbars
125 x 12 mm.**

- Ideal supplementary device for busbar bending and hole punching device.
- Cutting time with electro-hydraulic pump depending on rail width 5 - 15 sec.
- Hold-down device and guidance fixture for central, precise cutting.
- Top cutter replaceable and resharpenable.
- Weight: 16 kg

ALFRA busbar cutting device – S 125	Prod.-No. 03250
-------------------------------------	---------------------------

Replacement top cutter	03251
------------------------	-------

With use of electro-hydraulic pump AHP M in direct connection with the cutting device, we recommend the use of a footswitch with START – STOP – OFF function.

Footswitch with START – STOP – OFF (direct connection to basic device 03200)	03865
---	-------

Footswitch with START – STOP – OFF (direct connection to hydraulic pump 03855)	03863
---	-------

As a drive we recommend Electro-hydraulic pump AHP M	03855
--	-------



Prod.-No. 03250

ALFRA – WORKSHOP TROLLEY

For the bus bar bending and hole punching device 03200SET and the busbar cutting device 03250

Ideal for transportation - also in vans with standard fittings

Specially-developed workshop trolley for storing both processing devices and saving space. The electro-hydraulic pump can be connected to a fitted 2-way valve in the trolley. The processing devices are connected to each other with hydraulic hoses.

2 support rollers fitted to the side of the table make bending and cutting of long rails easier.

The trolley has an additional drawer with tool compartments for storing all punches and dies. The trolley runs on 4 casters, 2 of which have a locking device.

The fittings include a single and double power socket in addition to a self-rolling 230 V connecting cable at 3 m length.

Table size:	1,050 x 700 mm
Dimensions:	L=1150, W=700, H=900 mm
Weight:	100 kg without devices

Workshop trolley, with 2-way valve, coupling, Drawer with tool compartments	Prod.-No. 03950
--	---------------------------



Prod.-No. 03950 illustration shows fitted workshop trolley

ALFRA 4-STATION PROCESSING TROLLEY

- For**
- bending busbars at 120 x 12 mm,
 - for punching busbars Ø 6.6 - 21.5 mm,
 - for cutting busbars 125 x 12 mm,
 - two additional hydraulic outputs for various applications

- The processing stations for busbar cutting and hole punching and for cutting are recessed in the table. This enables quick, clean working
- You can use a hand wheel to infinitely variably raise and lower the universal working cylinder by hydraulic power according to the hole pattern to be punched
- The processing devices are connected to a hydraulic central unit fitted to the inside of the trolley
- A support extension, which can be pulled out of the side, is provided as a support for longer rails
- Press heads (e.g. press head 10 - 300 mm² Prod.-No. 03360) and hydraulic cylinder Prod.-No. 02012 can be connected to 2 hydraulic hoses fitted to the side for hole-punching
- 1 footswitch including connecting cable is included in delivery. Up to 3 **additional** foot switches can be connected to the various stations
- 4 tool drawers with compartments for punches and dies are fitted to the trolley.
It runs on 4 casters, 2 of which have a locking device

Technical data:

Motor voltage:	230 V / 50 Hz
Motor power:	2.2 kW
max. operating pressure:	700 bar
Flow rate:	max. 1.7 l/min.
Tank volume:	3.2 l
Usable oil volume:	2.2 l
Weight approx.:	240 kg
Table size:	1,150 x 700 mm
Dimensions L x W x H:	1,250 x 760 x 1,210 mm



Prod.-No. 03980 supplied without additional devices

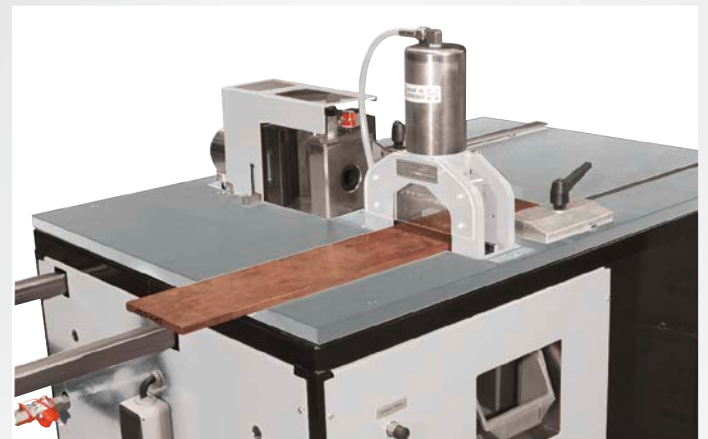

punches and dies are fitted to the trolley.

ALFRA 4-Station processing trolley	Prod.-No. 03980
------------------------------------	---------------------------

Required extra accessories

Punches and dies Ø 6.6 - 21.5 mm
Puncher: Prod.-No. 03204 - 03214
Dies: Prod.-No. 03230 - 03240

Hydraulic press head 10 - 300 mm ²	03360
---	-------

Hydraulic cylinder	02012
--------------------	-------

Footswitch with connecting cable, 3-pole	03861
--	-------

ALFRA BUSBAR BENDING AND HOLE PUNCHING DEVICE – LPV

Bending busbars up to 120 x 12 mm
Punching busbars Ø 6.6 up to 21.5 mm

The device consists of a base frame made of torsion-free aluminium profile with a mounting for the base bodies for bending and punching. A length limit stop makes adjustment of the hole arrangement easier during punching. To make working with longer copper rails easier, the insert frame with support frame can be extended to up to around 700 mm. All limit stops and support frames are quick and easy to fix using clamping levers.

Technical data:

Bending:

Bending Cu max: 120 x 12 mm
 Bending up to: more than 90°
 smallest leg length: 50 mm
 smallest U-bend: 100 mm
 smallest Z-bend: 72 mm
 The values stated are based on copper rails 120 x 10 mm

Punching:

Punching Cu: Ø 6.6 - 21.5 mm
 also longitudinal hole up to max. L = 21 mm
 Material thickness Cu max: 12 mm
 Material width up to: 110 mm central
 Dimensions L x W x H: 615 x 370 x 315 mm
 Weight: 44 kg

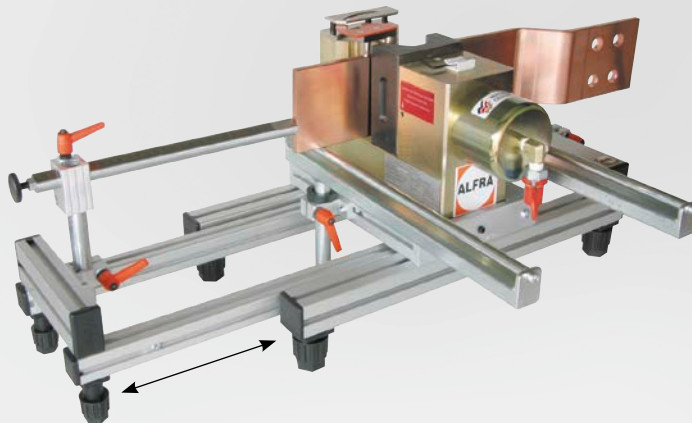

Prod.-No. 03256 scope of delivery without punches and dies



We recommend our electro-hydraulic pump AHP S Prod.-No. 03854 as a drive

ALFRA busbar bending and hole punching device – LPV

Prod.-No.
03256

Accessories

Available punches and dies

Punch Ø in mm	Metric Screw connection	Max. Material thickness in mm	Prod.-No.
6.6	6.0	5.0	03204
9.0	8.0	6.0	03205
9.5	8.0	6.0	03206
11.0	10.0	12.0	03207
11.5	10.0	12.0	03208
13.5	12.0	12.0	03209
14.0	12.0	12.0	03210
17.5	16.0	12.0	03211
18.0	16.0	12.0	03212
21.0	20.0	12.0	03213
21.5	20.0	12.0	03214



Die Ø Max. in mm	Material thickness in mm	Prod.-No.
6.6	5.0	03230
9.0	6.0	03231
9.5	6.0	03232
11.0	12.0	03233
11.5	12.0	03234
13.5	12.0	03235
14.0	12.0	03236
17.5	12.0	03237
18.0	12.0	03238
21.0	12.0	03239
21.5	12.0	03240

Punches and dies for longitudinal holes up to max. L x W = 21 x 18 mm upon request **Prod.-No.** 03241

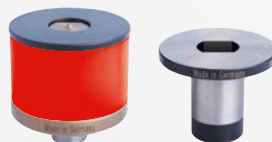

longitudinal hole punches and dies

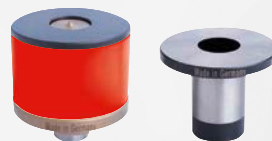

Round punches and dies

ALFRA BUSBAR BENDING AND HOLE PUNCHING DEVICE – BS 160

- The device consists of a base frame made of special aluminium and a hydraulic cylinder up to 600 bar
- Using bending dies R=11 mm and R=5 mm and height adjustment, all busbars of up to max. 160 mm width can be bent to various angles
- The angle measurement is engraved on the top section
- Changing over to bending and hole-punching is easy and simple

Technical data:

Bending

Bending Cu max.:	160 x 12 mm
Bending angle up to:	92°
smallest leg length:	50 mm internal dimension
smallest U-bend:	160 mm internal dimension
smallest Z-bend:	55 mm (material-dependent) internal dimension

Punching

Punching Cu max.:	Ø 6.6 - 21.5 mm also longitudinal hole up to max. L = 21 mm
Material thickness Cu max.:	12 mm
Material width up to:	160 mm central
Dimensions L x W x H:	390 x 150 x 330 mm
Weight:	20 kg

Recommended drive type

Electro-hydraulic pump AHP S	Prod.-No. 03854
Air-hydraulic pump LHP 700	Prod.-No. 02140
Foot pump	Prod.-No. 02121

	Prod.-No.
ALFRA BS 160 with bending die R=11 mm for busbars 9-12 mm	03258

Accessories

Bending die R=5 mm for busbars 3-8 mm	03259
---------------------------------------	-------

Available punches and dies

Punch Ø in mm	Metric Screw connection	Max. Material thickness in mm	Prod.-No.
6.6	6.0	5.0	03204
9.0	8.0	6.0	03205
9.5	8.0	6.0	03206
11.0	10.0	12.0	03207
11.5	10.0	12.0	03208
13.5	12.0	12.0	03209
14.0	12.0	12.0	03210
17.5	16.0	12.0	03211
18.0	16.0	12.0	03212
21.0	20.0	12.0	03213
21.5	20.0	12.0	03214

Die Ø Max. in mm	Material thickness in mm	Prod.-No.
6.6	5.0	03230
9.0	6.0	03231
9.5	6.0	03232
11.0	12.0	03233
11.5	12.0	03234
13.5	12.0	03235
14.0	12.0	03236
17.5	12.0	03237
18.0	12.0	03238
21.0	12.0	03239
21.5	12.0	03240

Punches and dies for longitudinal holes up to max. L x W = 21 x 18 mm	Prod.-No.
	03241

Bending busbars up to 160 x 12 mm

Punching busbars Ø 6.6 - 21.5 mm



ALFRA – FLEXIBLE BUSBAR PROCESSING DEVICE

for punching (without insulation) and cutting of flexible supple bars

Thickness up to 10 mm (without insulation)
Width up to 100 mm (without insulation)

Application areas:

- Cutting and punching of flexible copper bars
- Cutting thickness: max. 10 mm
- Hole range: Through holes for bolts M6 – M14
- Dimensions L x W x D: 400 x 250 x 150 mm (without limit stop)
- Weight: 32 kg

Basic device

- Used for mounting of: cutting block and punching tools
- The pressure unit, consisting of hydraulic piston and cylinder including puncher mounting in the top section, is permanently integrated in the basic unit
- The concentric locating hole for the die and cutting block insert are located in the bottom section. In addition, foldable limit stops are fitted to the front and side for hole punching in the device



Prod.-No.

03300

03301

Prod.-No. 03300

ALFRA flexible busbar processing device

Cutting block

Accessories

Punch with neoprene and pressure plates:

- Ø 6.0 mm
- Ø 9.0 mm
- Ø 11.0 mm
- Ø 14.0 mm



03304

03305

03306

03307

Die:

- Ø 6.0 mm
- Ø 9.0 mm
- Ø 11.0 mm
- Ø 14.0 mm



03309

03310

03311

03312

Other diameters on request.



Prod.-No. 02121



Prod.-No. 03854



Prod.-No. 03301 cutting block with length limit stop.

We recommend our electro-hydraulic pump AHP S as a drive
Prod.-No. 03854 or our foot pump Prod.-No. 02121.

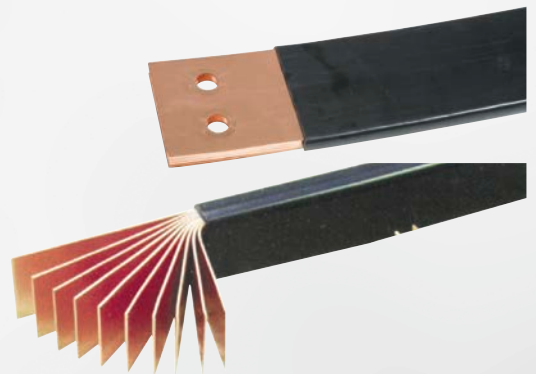

ALFRA HYDRAULIC CRIMPING UNIT

C-shape for simple handling

- C-shape, press head rotatable through 320°, hydraulics integrated in handle. Automatic switchover from rapid feed to press feed
- Fitted pressure limiting valve
- Replaceable hexagonal press inserts, semicircular
- Supplied in plastic case

Technical data:

Pressing force:	130 kN
Pressing power:	700 bar
Weight:	5.4 kg
Opening width:	26 mm
Length:	545 mm

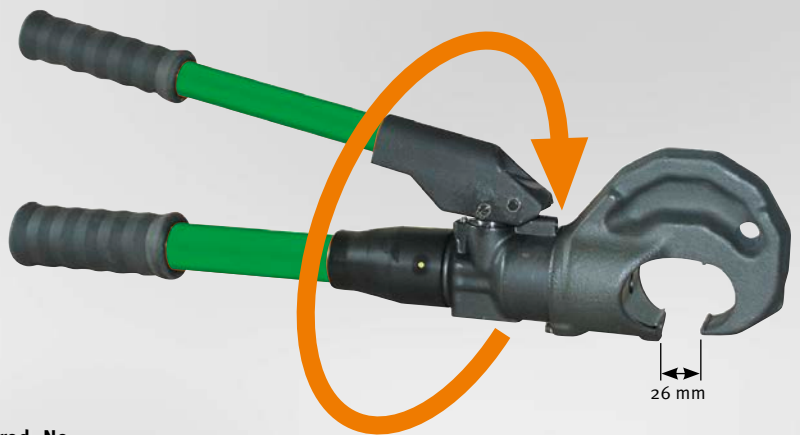

26 mm

Hydraulic crimping unit

Prod.-No.

03361

Prod.-No. 03361 head can be rotated through 320°

Hexagonal press inserts

Semicircular pressing shape for cable shoes and connectors

suitable for pressing units 03360/03380/03361

Tool Ref.no.	Press width mm	Copper Cross-section in mm ²	Aluminium Cross-section in mm ²	Prod.-No.
8	14	16	–	03365
10	14	25	–	03366
12	12	35	25	03367
14	12	50	35	03368
16	12	70	50	03369
18	12	95	70	03370
20	12	120	–	03371
22	14	150	95 + 120	03372
25	14	185	150	03373
28	14	240	185	03374
30	5	–	–	03375
32	5	300	240	03376
34	5	–	300	03377



Hexagonal press inserts

Notes on hexagonal pressings

(Manufacturer information is definitive)

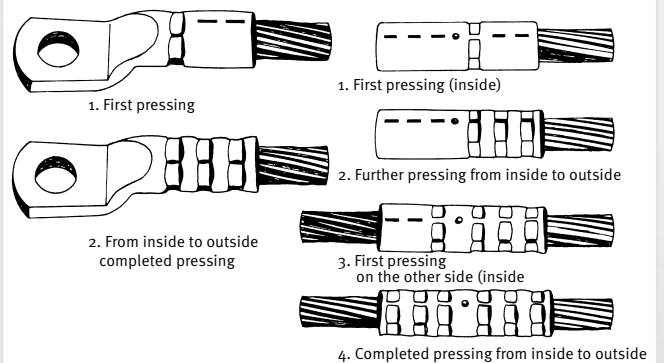

ALFRA HYDRAULIC PRESS HEADS

C-shape for simple handling

- pressing cable shoes and connectors made of copper and aluminium of between 10 – 300 mm²
- Hexagonal press inserts semicircular
- Supplied in sheet steel transport boxes
- Electro-hydraulic pump Prod.-No. 03854 or foot pump 02121 can be used to operate both press heads

Technical data:

Pressing force:	130 kN
Pressing power:	700 bar
Weight:	3.9 kg
Opening width:	26 mm
Length:	245 mm

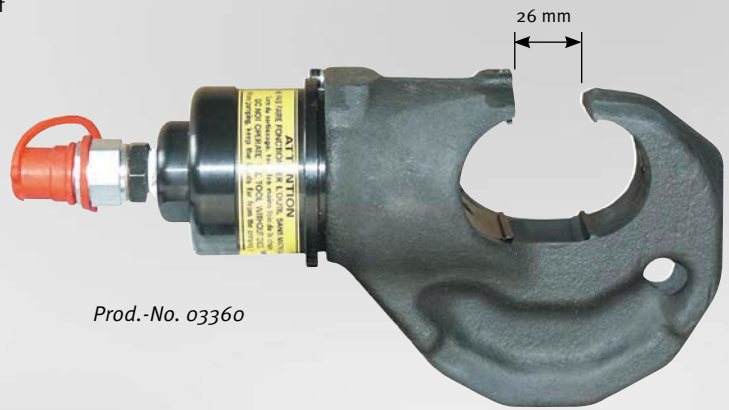

Prod.-No. 03360

Hydraulic press head

Prod.-No.
03360

Technical data:

Pressing force:	130 kN
Pressing power:	700 bar
Weight:	4.6 kg
Opening width:	38 mm
Length:	275 mm



Prod.-No. 03380

Hydraulic press head

Prod.-No.
03380

Hexagonal press inserts

Semicircular pressing shape for cable shoes and connectors

suitable for pressing units 03360/03380/03361

Tool Ref.no.	Press width mm	Copper Cross-section in mm ²	Aluminium Cross-section in mm ²	Prod.-No.
8	14	16	-	03365
10	14	25	-	03366
12	12	35	25	03367
14	12	50	35	03368
16	12	70	50	03369
18	12	95	70	03370
20	12	120	-	03371
22	14	150	95 + 120	03372
25	14	185	150	03373
28	14	240	185	03374
30	5	-	-	03375
32	5	300	240	03376
34	5	-	300	03377



Hexagonal press inserts

ALFRA HYDRAULIC CABLE CUTTER – AKS 85

Ideal for cutting cables up to Ø 85 mm

Advantages

- Guided cutter blade
- Independent, can be used in any location
- Clean cuts at minimal deformation

Application areas:

Power supply companies, power distribution construction, telecommunications, municipal utilities and their providers, crane construction, mining, shipbuilding, maintenance or repair etc.

Technical data:

Cutting force: 55 kN
 Cutting pressure: 700 bar
 Weight: 6.3 kg
 Length: 450 mm

Cutting performance:

telephone cable: up to Ø 85 mm
 electric cable with armouring: up to Ø 85 mm
 insulated aluminium cable: 3 x 240 mm²
 (earthing cable)
 insulated aluminium cable: 630 mm²
 (single-core)
 aluminium wire: up to Ø 46 mm
 copper wire: up to Ø 28 mm

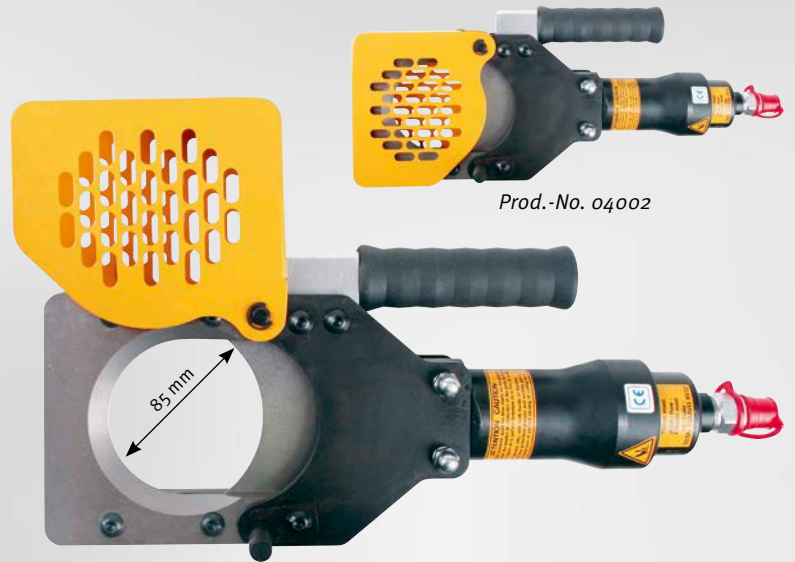
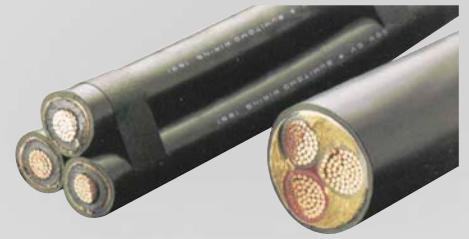

Prod.-No. 04002

Prod.-No.

Hydraulic cable cutter AKS 85
 supplied in sailcloth bag

04002

ALFRA HYDRAULIC MANUAL CABLE CUTTER – HKS 85

With built-in manual hydraulics for cutting cables up to Ø 85 mm

The most ergonomic working position can be selected thanks to the integrated hydraulics in the rotating handle. The cable cutter can be used on scaffolds, on high tension pylons or in manholes etc. independently of hydraulic pumps.

Application areas:

Power supply companies, power distribution construction, telecommunications, municipal utilities and their providers, crane construction, mining, shipbuilding, maintenance or repair etc.

Technical data:

Cutting force: 55 kN
 Cutting pressure: 700 bar
 Weight: 6.6 kg
 Length: 740 mm

The cutting performance is equivalent to Type AKS 85.

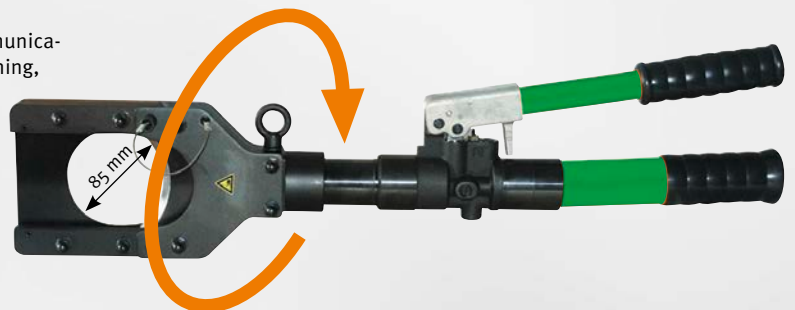

Prod.-No.

Hydraulic manual cable cutter HKS 85
 supplied in sailcloth bag

04015

Prod.-No. 04015 head can be rotated through 320°

CONTROL CABINET CONSTRUCTION WITH ALFRA PRESS

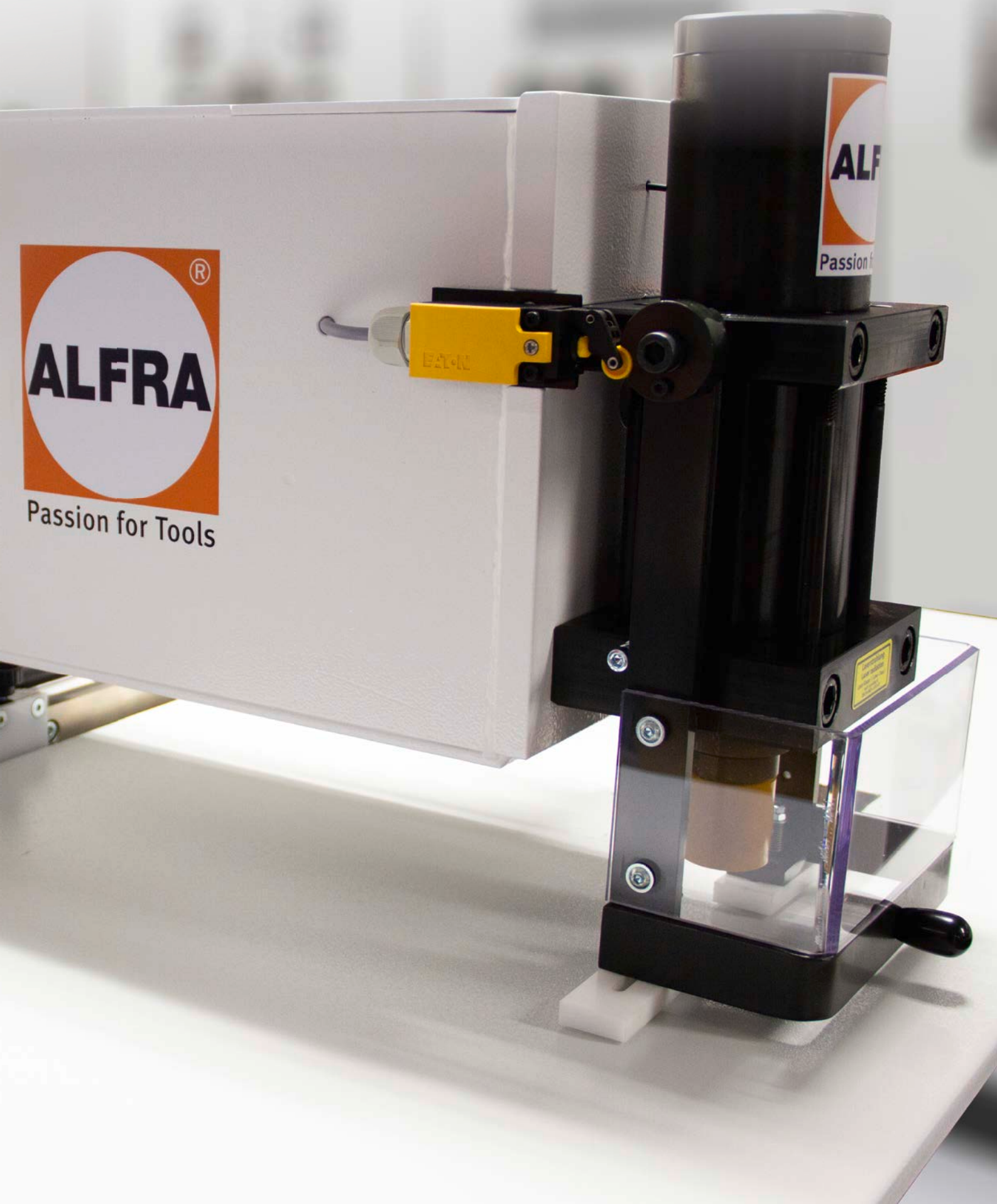



ALFRA PRESS – OVERVIEW



ALFRA PRESS AP 250

Page	70	
Application	Control cabinet housing, Control cabinet doors, Mounting panels	
Prod.-No.	03170	
Overhang with limit stop in mm	250	
Overall height in mm	820	
Total weight in kg approx.	50 (without base)	
Space requirement in mm	1,000 x 1,000	
Tool dimension in mm:		
Circular Ø	3.2 – 40.5	
Square up to	28.0 x 28.0	
Max. diagonals of	40.0	
Max. material thickness in mm:		
Sheet steel S235 / stainless steel	2.5 / 2.0	
Aluminium / plastic	4.0	
Hydraulic system:		
Mode of action	single-action	
Punching force F	46 kN at 600 bar	
Punching stroke in mm	50	
Operating voltage in V	-	
Workpiece fold in mm	22	

ALFRA PRESS – OVERVIEW



ALFRA PRESS AP 400



ALFRA PRESS AP 600

	74	78
	Control cabinet housing, Control cabinet doors, Mounting panels	Control cabinet doors, Mounting panels
	03195	03090
	400	600
	1,700	1,600
	220	360
	1,200 x 800	2,000 x 3,000
	3.2 – 40.5	3.2 – 70.0
	28.0 x 28.0	68.0 x 68.0
	40.0	90.0
	2.5 / 2.0	3.0 / 2.0
	4.0	4.0
	single-action	double-action
	46 kN at 600 bar	60 kN at 165 bar
	50	66
	-	400
	22	30

PUNCHING WITHOUT PRE-DRILLING

Apress 250

Overhang 250 mm



ALFRA PRESS AP 250

For rapid punching-out of circular, square, rectangular or special forms without pre-drilling in control cabinet doors, terminal boxes, cable ducts, housings, cable management panels etc. right up to margins. Simple tool change carried out in seconds.

Description:

- Flexible in use – on mobile base (optional) or stationary, fitted on the workbench
- Rapid tool change helps in problem areas with a wide range of breakthrough types
- A range of die mountings is available, even for punching very close to margins
- Rows of punch-outs are no problem thanks to attachable folding stops
- Tip: Use a laser pointer as an option - no scribing, no centre punching, a simple crosshair with the pin is sufficient
- Operation using a manual pump is sufficient as a “starter solution” – this makes “punching without pre-drilling” possible at low cost

Technical data:

Overhang with limit stop:	250 mm
Overhang without limit stop:	265 mm
Punching stroke:	50 mm
Punching force F:	46 kN at 600 bar
Hydraulic connection:	R 1/4"
Weight without base:	50 kg
Weight with base:	120 kg
Space requirement with base approx.:	1,000 mm x 1,000 mm

Punching capacity:

Circular:	Ø 3.2 - 40.5 mm
Square:	28.0 x 28.0 mm
Rectangle:	22.0 x 30.0 mm
Special forms up to a max. diagonal of:	40.0 mm

Material thicknesses (max):

Sheet steel (S235):	2.5 mm
Stainless steel (F = 600 N/mm ²):	2.0 mm
Aluminium (F = 22 N/mm ²):	4.0 mm
Punchable plastics:	4.0 mm

ALFRA PRESS AP 250 (without options)

Prod.-No.
03170

Note:

- All circular tools for ALFRA PRESS punchers AP 250 - AP 800 are made of special tool steel and have a special cutting geometry developed by ALFRA

Special tools can be manufactured in our own toolmaking works at short notice!

Technical features when punching close to margins with die holder Type I

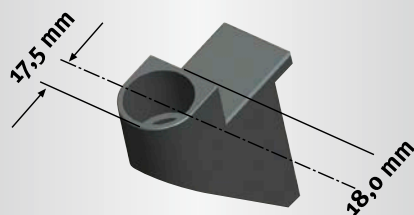

Smallest-possible axial dimension (border spacing) when using die holder Type I

Prod.-No. 03174

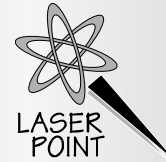
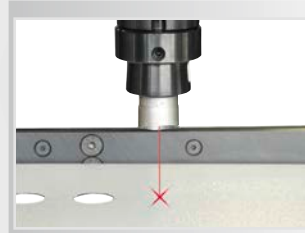

Laser pointer for optical display of tool centre



Tool drawer, pivoting



Length and depth limit stop with foldable add-on stops



Pivoting support arms, height adjustable, each with 2 rubber supports (option)



Prod.-No. 03854

We recommend our electro-hydraulic pump AHP S (Prod.-No. 03854) as a drive unit

PUNCHING WITHOUT PRE-DRILLING



Overhang 250 mm

Stationary hole puncher – AP 250

Type	Designation	Prod.-No.
Machine	Punching machine ALFRA PRESS 250 with hydraulic cylinder and quick coupling, cylinder piston with non-twist device for insertion of all punch sockets	03170
Pump	Electro-hydraulic pump AHP S	03854
Special fitting	Foot switch 2-pedal for electro-hydraulic pump AHP S	03866
	Laser pointer, cpl. with power unit and connector plug for separate mains cable 230V/50Hz	03182
	Combined length and depth limit stops with 2 adjustable limit stops per axis. The limit stops in the X direction are foldable and are suitable as an add-on limit stop for rows of punch-outs.	03177
	Pivoting support arms (pairs) height adjustable, each with 2 rubber supports	03179
	Mobile base	03189
Punch socket	with scraper and centring pin Ø 3.2 - 30.5 mm with mounting shaft for AP 250 - 400	03171
	with scraper and centring pin for round puncher Ø 32.5 - 40.5 mm with 19 mm Female thread for AP 250 - 400	03172
Die holder	Type I Dies Ø 3.2 - 22.5 mm for punching right up to margins for AP 250 - 400	03174
	Type II Dies Ø 3.2 - 30.5 mm and moulding tool up to 21 x 21 mm (30.5 mm max. diagonals) for AP 250 - 400	03175
	Type IV Dies Ø 30.6 - 40.5 mm and moulding tool up to 28 x 28 mm (40.0 mm max. diagonals) AP 250 - 400	03176

Square and rectangular hole punches – AP 250

suitable for steel, for stainless steel applications on request, with mounting shaft and centring point, including die

Type	Designation	Prod.-No.	AP 250	AP 400	AP 500	AP 600
Square holes	21.0 x 21.0 mm for AP 250 - 400	03087	●	●		
	25.4 x 25.4 mm for AP 250 - 400	03088	●	●		
Rectangular holes	22.0 x 30.0 mm for AP 250 - 400	03089	●	●		
Special holes	Ø 22.5 mm with 4 lugs for AP 250 - 400	03086	●	●		
Spare neoprene scraper	for punch socket (03171) Ø 3.2 - 30.5 mm	03185	●	●		
	for punch socket (03172) Ø 30.6 - 40.5 mm	03186	●	●		

ALFRA PRESS AP 250

Circular punches and dies – AP 250 suitable for steel and stainless steel

Type	Mounting holder	Ø in mm	Size Metric	Size PG	Prod.-No.	AP 250	AP 400	AP600
Punch Ø 3.2 - 30.5 mm		3.2			03131	●	●	●
		4.5			03132	●	●	●
		5.4			03133	●	●	●
		6.5			03134	●	●	●
		8.5	M8		03135	●	●	●
		10.5	M10		03136	●	●	●
		12.7	M12	PG7	03137	●	●	●
		15.2		PG9	03138	●	●	●
		16.2	M16		03139	●	●	●
		18.6		PG11	03140	●	●	●
		20.4	M20	PG13	03141	●	●	●
		22.5		PG16	03142	●	●	●
		25.4	M25		03143	●	●	●
		28.3		PG21	03144	●	●	●
Punch Ø 32.5 - 40.5 mm		32.5	M32		03146	●	●	●
		37.0		PG29	03158	●	●	●
		40.5	M40		03147	●	●	●
Die Ø 3.2 - 22.5 mm	TYPE I	3.2			03500	●	●	
		4.5			03501	●	●	
		5.4			03502	●	●	
		6.5			03503	●	●	
		8.5	M8		03504	●	●	
		10.5	M10		03505	●	●	
		12.7	M12	PG7	03506	●	●	
		15.2		PG9	03507	●	●	
		16.2	M16		03508	●	●	
		18.6		PG11	03509	●	●	
		20.4	M20	PG13	03510	●	●	
22.5		PG16	03511	●	●			
Die Ø 3.2 - 30.5 mm	TYPE II	3.2			03063	●	●	●
		4.5			03066	●	●	●
		5.4			03068	●	●	●
		6.5			03074	●	●	●
		8.5	M8		03076	●	●	●
		10.5	M10		03079	●	●	●
		12.7	M12	PG7	03022	●	●	●
		15.2		PG9	03023	●	●	●
		16.2	M16		03084	●	●	●
		18.6		PG11	03024	●	●	●
		20.4	M20	PG13	03025	●	●	●
		22.5		PG16	03026	●	●	●
		25.4	M25		03085	●	●	●
		28.3		PG21	03110	●	●	●
30.5			03111	●	●	●		
Die Ø 30.6 - 40.5 mm	TYPE IV	32.5	M32		03165	●	●	
		37.0		PG29	03166	●	●	
		40.5	M40		03167	●	●	

PUNCHING WITHOUT PRE-DRILLING

ALFRApress 400

Overhang 400 mm



ALFRA PRESS AP 400

For rapid punching-out in circular, square, rectangular or special forms without pre-drilling in control cabinet doors, terminal boxes, cable ducts, housings, cable management panels etc. right up to margins. Simple tool change carried out in seconds.

Description:

- Flexible in use – on mobile base
- Rapid tool change helps in problem areas with a wide range of break-through types
- A range of die mountings is available, even for punching very close to margins
- Rows of punch-outs are no problem thanks to attachable folding stops.
- Tip: Use a laser pointer as an option – no scribing, no centre punching, a simple crosshair with the pin is sufficient
- Operation using a manual pump is sufficient as a “starter solution” – this makes “punching without pre-drilling” possible at low cost

Technical data:

Overhang with limit stop:	400 mm
Overhang without limit stop:	430 mm
Punching stroke:	50 mm
Punching force F:	46 kN at 600 bar
Hydraulic connection:	R 1/4"
Weight:	220 kg
Space requirement with base approx.:	1,200 x 800 mm

Punching capacity:

Circular from:	Ø 3.2 - 40.5 mm
Square up to:	28.0 x 28.0 mm
Rectangular up to:	22.0 x 30.0 mm
Special forms up to a max. diagonal of:	40.0 mm

Material thicknesses (max):

Sheet steel (S235):	2.5 mm
Stainless steel (F = 600 N/mm ²):	2.0 mm
Aluminium (F = 22 N/mm ²):	4.0 mm
Punchable plastics:	4.0 mm

Prod.-No.

ALFRA PRESS AP 400 (without options)

03195

Note:

- All circular tools for ALFRA PRESS punchers AP 250 - AP 800 are made of special tool steel and have a special cutting geometry developed by ALFRA

Special tools can be manufactured in our own toolmaking works at short notice!

Technical features when punching close to margins with die holder Type I

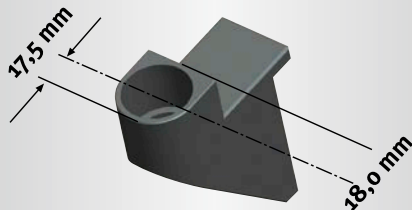

Smallest-possible axial dimension (border spacing) when using die holder Type I

Prod.-No. 03174



Laser pointer for optical display of tool centre



Die holder Type II



Tool drawer, pivoting



Length and depth limit stop with foldable add-on stops (Option)



Pivoting support arms, height adjustable, each with 3 rubber supports (option)



Prod.-No. 03854

We recommend our electro-hydraulic pump AHP S (Prod.-No. 03854) as a drive unit

PUNCHING WITHOUT PRE-DRILLING



Overhang 400 mm

Stationary hole puncher – AP 400		
Type	Designation	Prod.-No.
Machine Pump	Punching machine ALFRA PRESS 400 with hydraulic cylinder and quick coupling, cylinder piston with non-twist device for insertion of all punch sockets	03195
	Electro-hydraulic pump AHP S	03854
Special fitting	Foot switch 2-pedal for electro-hydraulic pump AHP S	03866
	Laser pointer, with power unit and connector plug for separate mains cable 230V/50Hz	03182
	Combined length and depth limit stops with 2 adjustable limit stops per axis. The limit stops in the X direction are foldable and are suitable as an add-on limit stop for rows of punch-outs.	03196
	Pivoting support arms (pairs) height adjustable, each with 2 rubber supports	03197
Punch socket	with scraper and centring pin Ø 3.2 - 30.5 mm with mounting shaft for AP 250 - 400	03171
	with scraper and centring pin for round puncher Ø 32.5 - 40.5 mm with 19 mm Female thread for AP 250 - 400	03172
Die holder	Type I Dies Ø 3.2 - 22.5 mm for punching right up to margins for AP 250 - 400	03174
	Type II Dies Ø 3.2 - 30.5 mm and moulding tool up to 21 x 21 mm (30.5 mm max. diagonals) for AP 250 - 400	03175
	Type IV Dies Ø 30.6 - 40.5 mm and moulding tool up to 28 x 28 mm (40.0 mm max. diagonals) AP 250 - 400	03176

Square and rectangular hole punches – AP 400 suitable for steel, for stainless steel applications on request, with mounting shaft and centring point, including die						
Type	Designation	Prod.-No.	AP 250	AP 400	AP 500	AP 600
Square holes	21.0 x 21.0 mm for AP 250 - 400	03087	●	●		
	25.4 x 25.4 mm for AP 250 - 400	03088	●	●		
Rectangular holes	22.0 x 30.0 mm for AP 250 - 400	03089	●	●		
Special holes	Ø 22.5 mm with 4 lugs for AP 250 - 400	03086	●	●		
Spare neoprene scraper	for punch socket (03171) Ø 3.2 - 30.5 mm	03185	●	●		
	for punch socket (03172) Ø 30.6 - 40.5 mm	03186	●	●		

ALFRA PRESS AP 400

Circular punches and dies – AP 400 suitable for steel and stainless steel

Type	Mounting holder	Ø in mm	Size Metric	Size PG	Prod.-No.	AP 250	AP 400	AP600
Punch Ø 3.2 - 30.5 mm		3.2			03131	●	●	●
		4.5			03132	●	●	●
		5.4			03133	●	●	●
		6.5			03134	●	●	●
		8.5	M8		03135	●	●	●
		10.5	M10		03136	●	●	●
		12.7	M12	PG7	03137	●	●	●
		15.2		PG9	03138	●	●	●
		16.2	M16		03139	●	●	●
		18.6		PG11	03140	●	●	●
		20.4	M20	PG13	03141	●	●	●
		22.5		PG16	03142	●	●	●
		25.4	M25		03143	●	●	●
		28.3		PG21	03144	●	●	●
		30.5			03145	●	●	●
Punch Ø 32.5 - 40.5 mm		32.5	M32		03146	●	●	●
		37.0		PG29	03158	●	●	●
		40.5	M40		03147	●	●	●
Die Ø 3.2 - 22.5 mm	TYPE I	3.2			03500	●	●	
		4.5			03501	●	●	
		5.4			03502	●	●	
		6.5			03503	●	●	
		8.5	M8		03504	●	●	
		10.5	M10		03505	●	●	
		12.7	M12	PG7	03506	●	●	
		15.2		PG9	03507	●	●	
		16.2	M16		03508	●	●	
		18.6		PG11	03509	●	●	
		20.4	M20	PG13	03510	●	●	
		22.5		PG16	03511	●	●	
Die Ø 3.2 - 30.5 mm	TYPE II	3.2			03063	●	●	●
		4.5			03066	●	●	●
		5.4			03068	●	●	●
		6.5			03074	●	●	●
		8.5	M8		03076	●	●	●
		10.5	M10		03079	●	●	●
		12.7	M12	PG7	03022	●	●	●
		15.2		PG9	03023	●	●	●
		16.2	M16		03084	●	●	●
		18.6		PG11	03024	●	●	●
		20.4	M20	PG13	03025	●	●	●
		22.5		PG16	03026	●	●	●
		25.4	M25		03085	●	●	●
		28.3		PG21	03110	●	●	●
		30.5			03111	●	●	●
Die Ø 30.6 - 40.5mm	TYPE IV	32.5	M32		03165	●	●	
		37.0		PG29	03166	●	●	
		40.5	M40		03167	●	●	

PUNCHING WITHOUT PRE-DRILLING

APress 600

Overhang 600 mm



ALFRA PRESS AP 600

The stationary punching machine has been developed for control cabinet and switch gear makers and is suitable for quick punching-out of circular, square, rectangular or special forms in sheet metal and control cabinet doors up to 2200 mm x 1000 mm and 30 mm margin fold height. Punching possible right up to margins.

Simple, rapid tool change carried out in seconds – even on fitted door. Limit stop system can be moved in X and Y directions.

Description:

- Stable press body in heavy-duty, torsionally-stiff welded construction
- Dual-action hydraulic cylinder, flanged force-locking and form-locking to machine body
- Anti-twist piston rod \varnothing 55 mm made of tempered stainless steel with tool holder
- Die bed, fixed force-locking to press body
- Rapid tool change helps in problem areas with a wide range of break-through types
- Hold-down device with safety function, fixed with electrical safety lock for accident prevention
- Length and depth limit stops movable in X and Y directions, bearings in hardened double ball bearing slides for smooth mobility
- Tape measure display for length and depth adjustment
- Digital measuring indicator optionally available for X and Y axes
- Dual-circuit hydraulic unit with electric pump, oil container and solenoid valves (very low noise)
- Safety footswitch with double pedal for infinitely variable operation of punching and return stroke

Technical data:

Overhang with limit stop:	600 mm
Punching stroke:	66 mm
Punching force F:	60 kN at 165 bar
Motor power:	0.75 kW
Operating voltage:	400 V
Weight approx.:	360 kg
Overall height:	1,600 mm
Working height:	1,000 mm
Width of puncher body:	310 mm
Depth of puncher body:	1,150 mm
Length of limit stock rails:	1,500 mm
Space requirement approx.:	2,000 x 3,000 mm

Punching capacity:

Circular from:	\varnothing 3.2 - 70.0 mm
Square up to:	68.0 x 68.0 mm
Special forms up to a max. diagonal of:	90.0 mm

Material thicknesses (max):

Sheet steel (S235):	3.0 mm
Stainless steel ($F = 600 \text{ N/mm}^2$):	2.0 mm
Aluminium ($F = 22 \text{ N/mm}^2$):	4.0 mm
Punchable plastics up to:	4.0 mm

ALFRA PRESS AP 600

Prod.-No.
03090

Note:

- All circular tools for ALFRA PRESS punching machines AP 250 - AP 800 are made of special tool steel and have a special cutting geometry developed by ALFRA

Special tools can be manufactured in our own toolmaking works at short notice!

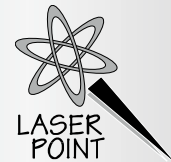
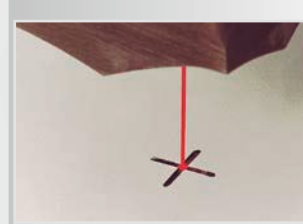

Laser pointer for optical display of tool centre



Stable piston rod (\varnothing 55 mm) with tool anti-twist device



Tool drawer with compartments



Dual-circuit hydraulic unit in cabinet base



Reciprocal quick-clamping system for edge folds either top or bottom



Die bed holder. Tool changes can also be carried out when control cabinet door is fitted



Length and depth limit stops guided in double ball bearing slides on both sides. 2 adjustable limit stops right and left on the Y-axis

PUNCHING WITHOUT PRE-DRILLING



Overhang 600 mm

Stationary hole puncher – AP 600		
Type	Designation	Prod.-No.
Machine	Stationary punching machine ALFRA PRESS 600 with hydraulic cylinder, cabinet base, length and depth limit stops movable in X and Y directions, cylinder pistons with anti-twist device for use with all punch sockets, dual-action hydraulic unit, safety footswitch, Laser pointer for optical display of tool centre, Digital measuring indicator Y-axis, Digital measuring indicator X-axis, Pivoting double joint arm for supporting workpiece (individual)	03090
Punch socket	with scraper and centring pin for round puncher with mounting shaft for AP 500 - 600 Ø 3.2 - 30.5 mm	03036
	with centring pin for round puncher with 19 mm female thread for AP 500 - 600 Ø 32.5 - 40.5 mm	03035
Die holder	Type A Circular die Type A Ø 3.2 - 25.4 mm	03040
	Type B Circular die Type A Ø 28.3 - 40.5 mm	03041
	Type C Circular die Type A Ø 40.6 - 63.5 mm	03077

Square and rectangular hole punches – AP 600						
suitable for steel, for stainless steel applications on request, with mounting shaft and centring point, including die						
Type	Designation	Prod.-No.	AP 250	AP 400	AP 500	AP 600
Square holes	12.7 x 12.7 mm for AP 500 - 600	03042			●	●
	19.0 x 19.0 mm for AP 500 - 600	03044			●	●
	22.2 x 22.2 mm for AP 500 - 600	03045			●	●
	25.4 x 25.4 mm for AP 500 - 600	03046			●	●
	46.0 x 46.0 mm for AP 500 - 600	03047			●	●
	68.0 x 68.0 mm for AP 600	03050				●
Rectangular holes	22.0 x 30.0 mm for AP 500 - 600	03048			●	●
	22.0 x 42.0 mm for AP 500 - 600	03049			●	●
Special holes	Ø 22.5 mm 1 lug 3.2 mm for AP 500 - 600	03051			●	●
	Ø 22.5 mm with 2 lugs 3.2 mm for AP 500 - 600	03052			●	●
	Ø 22.5 mm, flattened on 4 sides to 20.1 mm for AP 500 - 600	03055			●	●

ALFRA PRESS AP 600

Circular punches and dies – AP 600

suitable for steel and stainless steel

Type	Mounting holder	Ø in mm	Size Metric	Size PG	Prod.-No.	AP 250	AP 400	AP600
Punch Ø 3.2 - 30.5 mm		3.2			03131	●	●	●
		4.5			03132	●	●	●
		5.4			03133	●	●	●
		6.5			03134	●	●	●
		8.5	M8		03135	●	●	●
		10.5	M10		03136	●	●	●
		12.7	M12	PG7	03137	●	●	●
		15.2		PG9	03138	●	●	●
		16.2	M16		03139	●	●	●
		18.6		PG11	03140	●	●	●
		20.4	M20	PG13	03141	●	●	●
		22.5		PG16	03142	●	●	●
		25.4	M25		03143	●	●	●
		28.3		PG21	03144	●	●	●
		30.5			03145	●	●	●
Punch Ø 32.5-63.5 mm		32.5	M32		03146	●	●	●
		37.0		PG29	03158	●	●	●
		40.5	M40		03147	●	●	●
		47.0		PG36	03159			●
		50.5	M50		03148			●
		54.0		PG42	03160			●
		60.0		PG48	03161			●
		63.5	M63		03149			●
Die Ø 3.2 - 25.4 mm	TYPE A	3.2			03063	●	●	●
		4.5			03066	●	●	●
		5.4			03068	●	●	●
		6.5			03074	●	●	●
		8.5	M8		03076	●	●	●
		10.5	M10		03079	●	●	●
		12.7	M12	PG7	03022	●	●	●
		15.2		PG9	03023	●	●	●
		16.2	M16		03084	●	●	●
		18.6		PG11	03024	●	●	●
		20.4	M20	PG13	03025	●	●	●
		22.5		PG16	03026	●	●	●
		25.4	M25		03085	●	●	●
Die Ø 28.3 - 40.5 mm	TYPE B	28.3		PG21	03027			●
		30.5			03028			●
		32.5	M32		03163			●
		37.0		PG29	03029			●
		40.5	M40		03164			●
Die Ø 47.0 - 63.5 mm	TYPE C	47.0		PG36	03030			●
		50.5	M50		03168			●
		54.0			03031			●
		60.0		PG48	03032			●
		63.5	M63		03169			●

TCT-HOLE SAWS IN USE



TCT-Hole Saws – short-/long type



Plastic



TCT-Hole Saws – FRP type



Poroton brick stone



Stainless steel





TCT-Hole Saws – MBS type



Sanitary pipes – type SML



Checker plate (stainless steel)



MBS Pro
Use on Rotabest Magnetic Drilling Machine
with MT3 – Arbor Prod.-No.: 0734003

ALFRA TCT-HOLE SAWS – SHORT TYPE

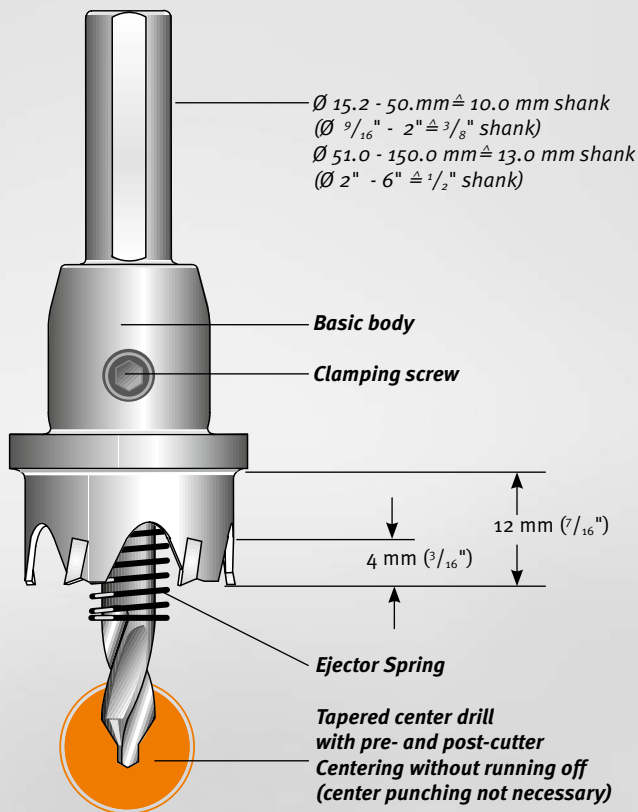

EDELSTAHL
STAINLESS STEEL



The application area of TCT Hole Saws differs from HSS-Bi-Metal Hole Saws. With ALFRA TCT Hole Saws, suitable to economically process stainless steel up to 2 mm ($\frac{1}{16}''$), unalloyed steels up to 4 mm ($\frac{3}{16}''$), plastics, PVC, aluminium, zinc, gypsum plaster boards and lightweight building boards, as well as asbestos. Do not use automatic feed, when working with pillar drilling machines. For the use on portable- and pillar drilling machines. Do not use automatic feed, when working with pillar drilling machines.

Features:

- High concentric running exactness through solid construction.
- CAD-optimized cutting angles with specially ground section ensures high cutting capacity and long tool life.
- Quick removal of drilled core through ejector spring for all hole saws up to 150 mm ($5-29/32''$) \varnothing .
- Carbide tipping enables repeated re-grinding.
- ALFRA hole saws are repairable. In the event of a tooth breaking, it can easily be replaced and resharpened.
- Exchangeable center pin.
- Use of MT tool holders from $\varnothing 31 \text{ mm}$ ($1-7/32''$).
- For use on hand drilling machines (recommended up to max. $\varnothing 40 \text{ mm}$; $1-9/16''$) or stationary machines.

Tips:

- At thicker materials: cut 2-3 mm ($\frac{1}{16}'' - 7/64''$) per cutting process, remove chips afterwards.
- When cutting metals, a high- grade cutting oil should be used. Exception: Do not use cutting oil when using cast iron, use paraffin instead of oil when cutting aluminium.
- **Keep in mind: Always wear safety goggles.**

Another special technical feature:

From $\varnothing 15.2 \text{ mm}$ ($\frac{3}{16}''$) to 30.0 mm ($1-1/8''$), the hole saw is made of one piece.

From $\varnothing 31.0 \text{ mm}$ ($1-3/16''$) we use specially hardened tool holders to compensate for the torsional power in case of heavy operation, which avoids early shearing off of the tool holder shank.

In terms of construction not comparable with any other make.

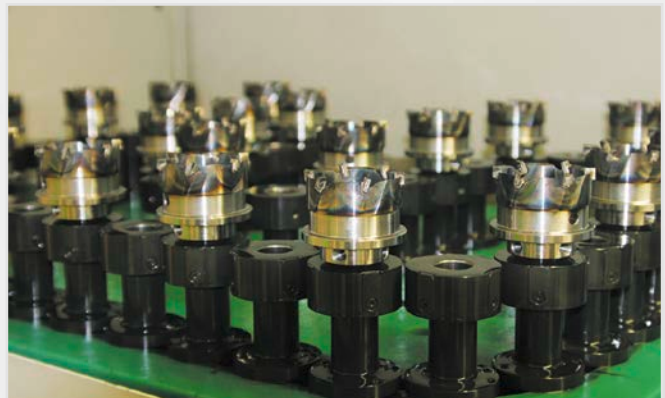
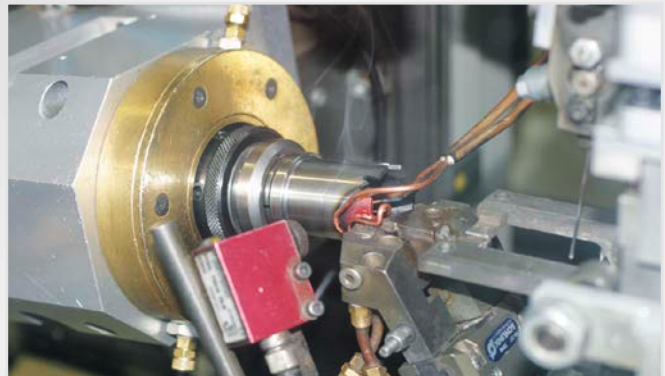

ALFRA TCT-HOLE SAWS – SHORT TYPE

Ø mm	Ø Inches	No. of teeth	Prod.-No.	Ø mm	Ø Inches	No. of teeth	Prod.-No.
Ø 15.2		4	0600152	Ø 77.0		13	0600770
Ø 16.0	5/8"	4	0600160	Ø 78.0	3-1/16"	14	0600780
Ø 17.0		4	0600170	Ø 79.0	3-1/8"	14	0600790
Ø 18.0	11/16"	4	0600180	Ø 80.0		14	0600800
Ø 18.6		4	0600186	Ø 81.0	3-3/16"	14	0600810
Ø 19.0	3/4"	4	0600190	Ø 82.0		14	0600820
Ø 20.0		5	0600200	Ø 83.0	3-1/4"	14	0600830
Ø 20.4		5	0600204	Ø 84.0	3-5/16"	15	0600840
Ø 21.0	13/16"	5	0600210	Ø 85.0		15	0600850
Ø 22.0		5	0600220	Ø 86.0	3-3/8"	15	0600860
Ø 22.5		5	0600225	Ø 87.0	3-7/16"	15	0600870
Ø 23.0	7/8"	5	0600230	Ø 88.0		15	0600880
Ø 24.0	15/16"	5	0600240	Ø 89.0	3-1/2"	16	0600890
Ø 25.0		5	0600250	Ø 90.0	3-9/16"	16	0600900
Ø 26.0	1"	5	0600260	Ø 91.0		16	0600910
Ø 27.0	1-1/16"	5	0600270	Ø 92.0	3-5/8"	16	0600920
Ø 28.0		5	0600280	Ø 93.0		16	0600930
Ø 28.3		5	0600283	Ø 94.0	3-11/16"	16	0600940
Ø 29.0	1-1/8"	5	0600290	Ø 95.0	3-3/4"	17	0600950
Ø 30.0	1-3/16"	5	0600300	Ø 96.0		17	0600960
Ø 31.0		6	0600310	Ø 97.0	3-13/16"	17	0600970
Ø 32.0	1-1/4"	6	0600320	Ø 98.0	3-7/8"	17	0600980
Ø 33.0		6	0600330	Ø 99.0		17	0600990
Ø 34.0	1-5/16"	6	0600340	Ø 100.0	3-15/16"	17	0601000
Ø 35.0	1-3/8"	6	0600350	Ø 105.0	4"	18	0601050
Ø 36.0		6	0600360	Ø 110.0		18	0601100
Ø 37.0	1-7/16"	7	0600370	Ø 115.0	4-1/2"	20	0601150
Ø 38.0		7	0600380	Ø 120.0		20	0601200
Ø 39.0	1-1/2"	7	0600390	Ø 125.0		20	0601250
Ø 40.0	1-9/16"	7	0600400	Ø 130.0	5"	20	0601300
Ø 41.0		8	0600410	Ø 135.0		24	0601350
Ø 42.0	1-5/8"	8	0600420	Ø 140.0	5-1/2"	24	0601400
Ø 43.0	1-11/16"	8	0600430	Ø 145.0		24	0601450
Ø 44.0		8	0600440	Ø 150.0		24	0601500
Ø 45.0	1-3/4"	8	0600450				
Ø 46.0		8	0600460				
Ø 47.0	1-13/16"	9	0600470				
Ø 48.0	1-7/8"	9	0600480				
Ø 49.0		9	0600490				
Ø 50.0	1-15/16"	9	0600500				
Ø 51.0	2"	9	0600510				
Ø 52.0		10	0600520				
Ø 53.0	2-1/16"	10	0600530				
Ø 54.0	2-1/8"	10	0600540				
Ø 55.0		10	0600550				
Ø 56.0	2-3/16"	10	0600560				
Ø 57.0	2-1/4"	10	0600570				
Ø 58.0		10	0600580				
Ø 59.0	2-5/16"	10	0600590				
Ø 60.0	2-3/8"	10	0600600				
Ø 61.0		11	0600610				
Ø 62.0	2-7/16"	11	0600620				
Ø 63.0		11	0600630				
Ø 64.0	2-1/2"	11	0600640				
Ø 65.0		11	0600650				
Ø 66.0	2-9/16"	12	0600660				
Ø 67.0	2-5/8"	12	0600670				
Ø 68.0		12	0600680				
Ø 69.0	2-11/16"	12	0600690				
Ø 70.0	2-3/4"	12	0600700				
Ø 71.0		12	0600710				
Ø 72.0	2-13/16"	13	0600720				
Ø 73.0	2-7/8"	13	0600730				
Ø 74.0	2-15/16"	13	0600740				
Ø 75.0		13	0600750				
Ø 76.0	3"	13	0600760				



Prod.-No. 0600001

Set Metric

Set Metric	Prod.-No.
Set Metric	0600001

Contents:
1 each of Ø 16 / 20 / 25 / 32 / 40 mm
2 Allen Keys

HSS-Spare Drill with tapered center tip

from Ø 15.2 - 100.0	Ø 6x50 mm	0602650
from Ø 101.0 - 150.0	Ø 8x50 mm	0602850

MT Arbors

MT-2 (Ø 31.0 - 100.0 mm)	0734002
MT-3 (Ø 31.0 - 150.0 mm)	0734003

SDS Arbor

SDS arbor shank (for use with Ø 31.0 - 100.0 mm)	060sds6
---	---------

Spare Ejector

from Ø 15.2 - 150.0	Ø 6 mm	0602006
---------------------	--------	---------

Coolant ALFRA

ALFRA 2000 For mild steel DIN S233, 250 ml	21010
--	-------

ALFRA 4000 For titanium and manganese-carbon steels 300 ml	21040
---	-------



Prod.-No. 21010

Prod.-No. 21040

ALFRA TCT-HOLE SAWS – LONG TYPE

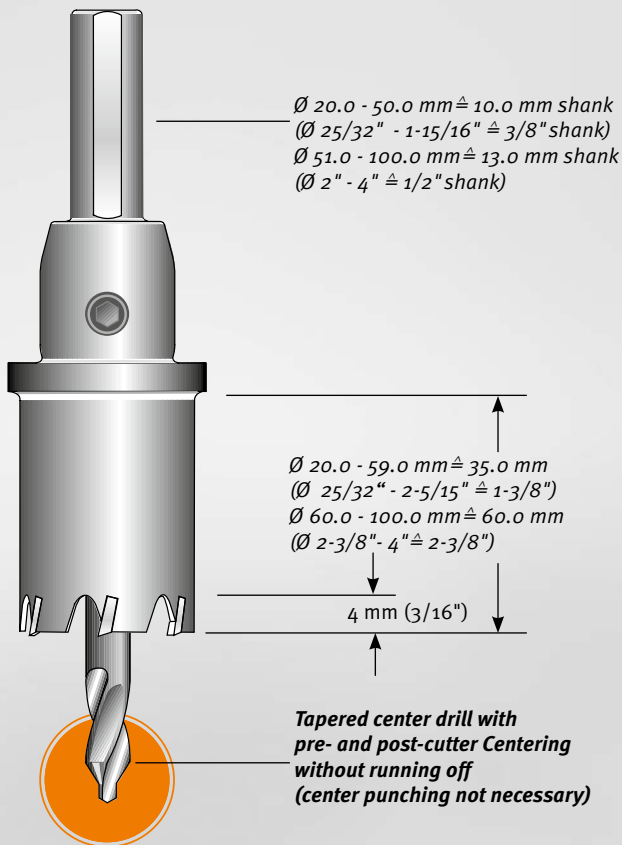

Features:

- Especially developed for the use on pipes, vaulted materials, for unalloyed and alloyed steels, nonferrous metals, plastics as well as glass fibre reinforced plastic.
- For material thickness up to 4 mm (3/16"), 2 mm (1/16") stainless steel.
- For use on hand drilling machines, recommended up to max. $\varnothing 40 \text{ mm}$ (1-9/16") or stationary machines.

Tips:

- Start drilling operation with light pressure, when drilling pipes. Avoid pendulum motions.
- **Keep in mind: Always wear safety goggles.**



Special tools for special applications on request!

ALFRA TCT-HOLE SAWS – LONG TYPE

Ø mm	Ø Inches	No. of teeth	Prod.-No.	Ø mm	Ø Inches	No. of teeth	Prod.-No.	Ø mm	Ø Inches	No. of teeth	Prod.-No.
Ø 16.0	5/8"	4	0700160	Ø 54.0	2-1/8"	12	0700540	Ø 92.0	3-5/8"	20	0700920
Ø 17.0		4	0700170	Ø 55.0		12	0700550	Ø 93.0		20	0700930
Ø 18.0	11/16"	4	0700180	Ø 56.0	2-3/16"	12	0700560	Ø 94.0	3-11/16"	22	0700940
Ø 19.0	3/4"	4	0700190	Ø 57.0	2-1/4"	12	0700570	Ø 95.0	3-3/4"	22	0700950
Ø 20.0		5	0700200	Ø 58.0		12	0700580	Ø 96.0		22	0700960
Ø 21.0	13/16"	5	0700210	Ø 59.0	2-5/16"	12	0700590	Ø 97.0	3-13/16"	22	0700970
Ø 22.0		5	0700220	Ø 60.0	2-3/8"	14	0700600	Ø 98.0	3-7/8"	22	0700980
Ø 23.0	7/8"	5	0700230	Ø 61.0		14	0700610	Ø 99.0		22	0700990
Ø 24.0	15/16"	6	0700240	Ø 62.0	2-7/16"	14	0700620	Ø 100.0	3-15/16"	22	0701000
Ø 25.0		6	0700250	Ø 63.0		14	0700630				
Ø 26.0	1"	6	0700260	Ø 64.0	2-1/2"	14	0700640				
Ø 27.0	1-1/16"	6	0700270	Ø 65.0		14	0700650				
Ø 28.0		6	0700280	Ø 66.0	2-9/16"	14	0700660				
Ø 29.0	1-1/8"	6	0700290	Ø 67.0	2-5/8"	16	0700670				
Ø 30.0	1-3/16"	6	0700300	Ø 68.0		16	0700680				
Ø 31.0		8	0700310	Ø 69.0	2-11/16"	16	0700690				
Ø 32.0	1-1/4"	8	0700320	Ø 70.0	2-3/4"	16	0700700				
Ø 33.0		8	0700330	Ø 71.0		16	0700710				
Ø 34.0	1-5/16"	8	0700340	Ø 72.0	2-13/16"	16	0700720				
Ø 35.0	1-3/8"	8	0700350	Ø 73.0	2-7/8"	16	0700730				
Ø 36.0		8	0700360	Ø 74.0	2-15/16"	16	0700740				
Ø 37.0	1-7/16"	8	0700370	Ø 75.0		16	0700750				
Ø 38.0		8	0700380	Ø 76.0	3"	18	0700760				
Ø 39.0	1-1/2"	8	0700390	Ø 77.0		18	0700770				
Ø 40.0	1-9/16"	10	0700400	Ø 78.0	3-1/16"	18	0700780				
Ø 41.0		10	0700410	Ø 79.0	3-1/8"	18	0700790				
Ø 42.0	1-5/8"	10	0700420	Ø 80.0		18	0700800				
Ø 43.0	1-11/16"	10	0700430	Ø 81.0	3-3/16"	18	0700810				
Ø 44.0		10	0700440	Ø 82.0		18	0700820				
Ø 45.0	1-3/4"	10	0700450	Ø 83.0	3-1/4"	18	0700830				
Ø 46.0		10	0700460	Ø 84.0	3-5/16"	20	0700840				
Ø 47.0	1-13/16"	10	0700470	Ø 85.0		20	0700850				
Ø 48.0	1-7/8"	10	0700480	Ø 86.0	3-3/8"	20	0700860				
Ø 49.0		10	0700490	Ø 87.0	3-7/16"	20	0700870				
Ø 50.0	1-15/16"	12	0700500	Ø 88.0		20	0700880				
Ø 51.0	2"	12	0700510	Ø 89.0	3-1/2"	20	0700890				
Ø 52.0		12	0700520	Ø 90.0	3-9/16"	20	0700900				
Ø 53.0	2-1/16"	12	0700530	Ø 91.0		20	0700910				

HSS-Spare Drill with tapered center tip



from Ø 20.0 - 59.0 Ø 6x80 mm	0702680
from Ø 60.0 - 100.0 Ø 8x100 mm	0702800

MT Arbors



MT-2 (from Ø 31.0)	0734002
MT-3 (from Ø 31.0)	0734003

SDS Arbor



SDS arbor shank (for use with Ø 31 - 59 mm)	060sds6
--	---------

HIGHLY RECOMMENDED ACCESSORIES – COOLANT AND LUBRICANT!

ALFRA 2000

ALFRA 2000 is a fully synthetic cutting oil, developed for high-quality cutting, threading and drilling of metals of any degree of hardness, ferrous metal, steel alloys, stainless steel, copper, aluminium and their alloys.

ALFRA 2000 is free of hydrocarbon, sulphur and chlorine.



ALFRA 4000

Suitable for core drilling applications with ALFRA cutters. Also ideal for twist drilling, thread tapping, reaming, countersinking, and difficult cutting applications. It meets to the requirements of work hygiene and safety.

ALFRA 4000 is a pump spray, free from propellant gas ideal for drilling and tapping of high-alloy, stainless steels; chromium nickel steels; titanium and manganese-carbon steels



Aerosol can 250 ml	21010
5 ltr. Plastic container	21012
60 ltr. Barrel	21021

Aerosol can 300 ml	21040
--------------------	-------

ALFRA TCT-HOLE SAWS – MBS-LIGHT

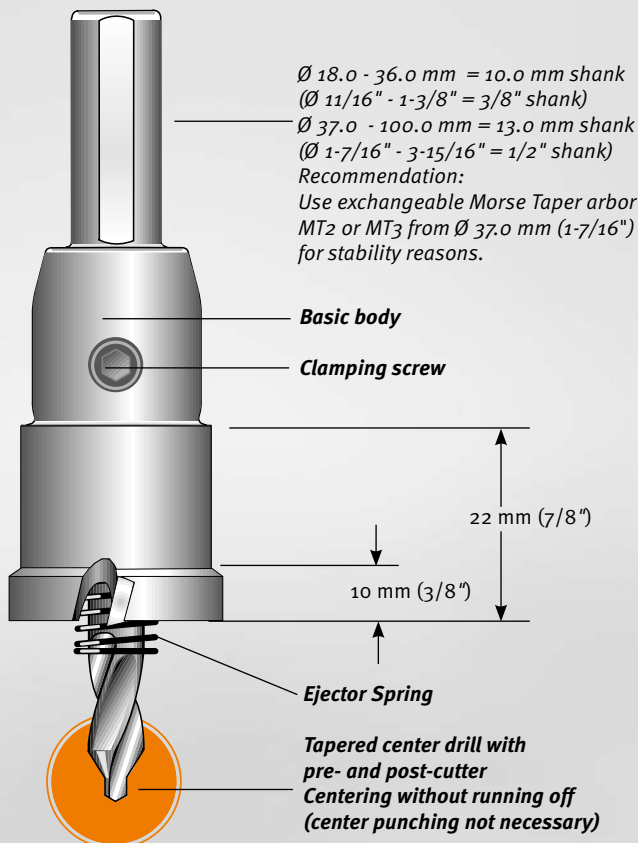

EDELSTAHL
STAINLESS STEEL



This TCT Hole Saw is a multi-range Hole Saw for the universal use up to a material thickness of max. 10 mm (3/8") (without ejector spring). Through its solid construction and an enhanced cutting geometry (Registered Utility Model No. 202 03 232 9), an improved cutting behaviour combined with a high cutting capacity and tool life, is achieved.

For the use on flat steel, as well as on pipes and vaulted materials. Cutting of overlapping holes is possible.

For use on stationary and hand drilling machines (recommended up to max. \varnothing 40 mm; 1-9/16").

- **Portable drilling Machines:** up to 4 mm (1/8") material thickness
- **Stationary drilling Machines:** up to 10 mm (3/8") material thickness (for material thickness over 6 mm (15/64"), it is necessary to settle and empty the chips several times).

In case of heavy operation, we recommend Morse Taper Tool Holders, which are suitable from \varnothing 37 mm (1-7/16").

Advantage: All MBS-Light type TCT Hole Saws are equipped with an ejector spring. The cut material is self-ejecting.

Another special technical feature:

From \varnothing 37 mm (1-7/16"), specially hardened tool holders are used to compensate for the torsional power in case of heavy operation which avoids early shearing off of the tool holder shank.

In terms of construction not comparable with any other make.

MBS – for almost limitless use

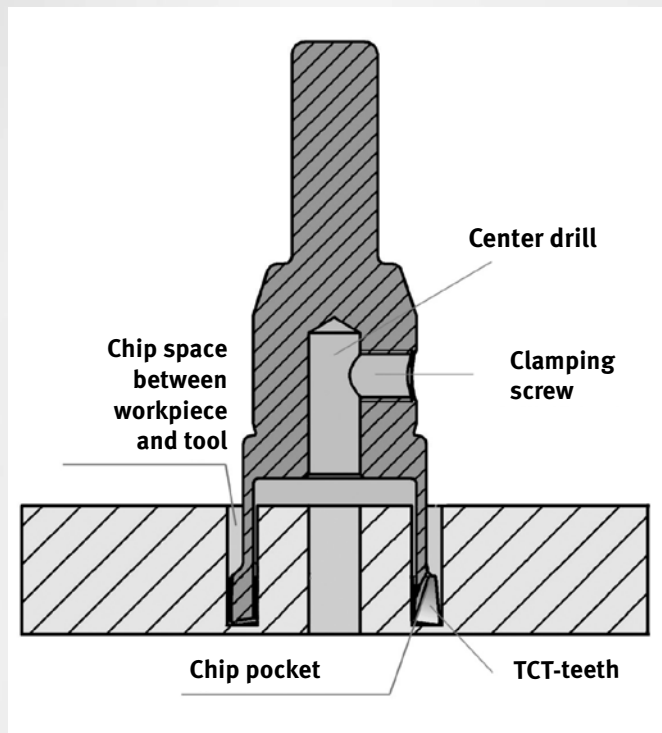

ALFRA TCT-HOLE SAWS – MBS-LIGHT

Ø mm	Ø Inches	No. of teeth	Prod.-No.	Ø mm	Ø Inches	No. of teeth	Prod.-No.
Ø 18.0	11/16"	4	0730018	Ø 79.0	3-1/8"	12	0730079
Ø 18.6		4	07300186	Ø 80.0		12	0730080
Ø 19.0	3/4"	4	0730019	Ø 81.0	3-3/16"	12	0730081
Ø 20.0		4	0730020	Ø 82.0		12	0730082
Ø 20.4		4	07300204	Ø 83.0	3-1/4"	12	0730083
Ø 21.0	13/16"	4	0730021	Ø 84.0	3-5/16"	12	0730084
Ø 22.0		4	0730022	Ø 85.0		12	0730085
Ø 22.5		4	07300225	Ø 86.0	3-3/8"	14	0730086
Ø 23.0	7/8"	4	0730023	Ø 87.0	3-7/16"	14	0730087
Ø 24.0	15/16"	4	0730024	Ø 88.0		14	0730088
Ø 25.0		4	0730025	Ø 89.0	3-1/2"	14	0730089
Ø 26.0	1"	6	0730026	Ø 90.0	3-9/16"	14	0730090
Ø 27.0	1-1/16"	6	0730027	Ø 91.0		14	0730091
Ø 28.0		6	0730028	Ø 92.0	3-5/8"	14	0730092
Ø 29.0	1-1/8"	6	0730029	Ø 93.0		14	0730093
Ø 30.0	1-3/16"	6	0730030	Ø 94.0	3-11/16"	14	0730094
Ø 31.0		6	0730031	Ø 95.0	3-3/4"	14	0730095
Ø 32.0	1-1/4"	6	0730032	Ø 96.0		14	0730096
Ø 33.0		6	0730033	Ø 97.0	3-13/16"	14	0730097
Ø 34.0	1-5/16"	6	0730034	Ø 98.0	3-7/8"	14	0730098
Ø 35.0	1-3/8"	6	0730035	Ø 99.0		14	0730099
Ø 36.0		6	0730036	Ø 100.0	3-15/16"	14	0730100

From Ø 37.0 mm (1-7/16") we recommend the use of MT arbors

Ø 37.0	1-7/16"	6	0730037
Ø 38.0		6	0730038
Ø 39.0	1-1/2"	6	0730039
Ø 40.0	1-9/16"	6	0730040
Ø 41.0		6	0730041
Ø 42.0	1-5/8"	6	0730042
Ø 43.0	1-11/16"	6	0730043
Ø 44.0		6	0730044
Ø 45.0	1-3/4"	6	0730045
Ø 46.0		6	0730046
Ø 47.0	1-13/16"	6	0730047
Ø 48.0	1-7/8"	6	0730048
Ø 49.0		6	0730049
Ø 50.0	1-15/16"	6	0730050
Ø 51.0	2"	6	0730051
Ø 52.0		6	0730052
Ø 53.0	2-1/16"	6	0730053
Ø 54.0	2-1/8"	6	0730054
Ø 55.0		6	0730055
Ø 56.0	2-3/16"	6	0730056
Ø 57.0	2-1/4"	6	0730057
Ø 58.0		6	0730058
Ø 59.0	2-5/16"	6	0730059
Ø 60.0	2-3/8"	8	0730060
Ø 61.0		8	0730061
Ø 62.0	2-7/16"	8	0730062
Ø 63.0		8	0730063
Ø 64.0	2-1/2"	8	0730064
Ø 65.0		8	0730065
Ø 66.0	2-9/16"	8	0730066
Ø 67.0	2-5/8"	8	0730067
Ø 68.0		8	0730068
Ø 69.0	2-11/16"	8	0730069
Ø 70.0	2-3/4"	8	0730070
Ø 71.0		10	0730071
Ø 72.0	2-13/16"	10	0730072
Ø 73.0	2-7/8"	10	0730073
Ø 74.0	2-15/16"	10	0730074
Ø 75.0		10	0730075
Ø 76.0	3"	10	0730076
Ø 77.0		12	0730077
Ø 78.0	3-1/16"	12	0730078

HSS-Spare Drill with tapered center tip

from Ø 18.0 - 60.0	Ø 6x50 mm	0602650
from Ø 61.0 - 100.0	Ø 8x50 mm	0602850

(old design)

MT Arbors

MT-2 (from Ø 37.0 mm)	0734002
MT-3 (from Ø 37.0 mm)	0734003

Weldon adaptor

from Ø 37.0 mm	060WD
----------------	-------

(incl. ejector pin Prod. No. 1950500)

Spare Ejector

For tapered center drill		
from Ø 18.0 - 60.0 mm	Ø 6 mm	0732006
from Ø 61.0 - 100.0 mm	Ø 8 mm	0732008



Drilling in checker sheet



Drilling in square profiles



Drilling in flat steel



Drilling in pipes

ALFRA TCT-HOLE SAWS – MBS-PRO

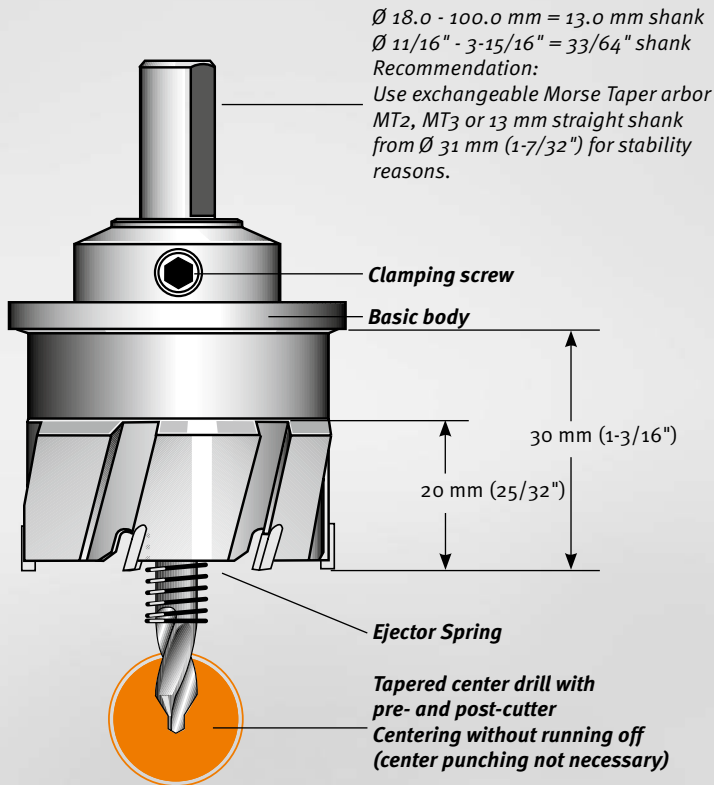

EDELSTAHL
STAINLESS STEEL



MBS-Multirange Hole Saws for universal use. **Max. cutting depth 20 mm (25/32")**

Suitable for flat materials but also for pipes and curved surfaces. Cutting of overlapping holes is possible. CAD optimized precision tools with high cutting performance and durability.

For use on stationary and portable drilling machines (recommended up to max. Ø 40 mm; 1-9/16")

- **Portable drilling Machines:** up to 6 mm (15/64") material thickness
- **Stationary drilling Machines:** up to 20 mm (25/32") material thickness at cutting depths from 6 mm (15/64") we recommend clearing the chips.

MBS hole saws can be resharpened, and it is possible to replace broken out teeth depending on the condition of the hole saw.

Advantages: All Alfra TCT Hole Saws MBS-Pro type are equipped with an ejector spring. The cut material is self-ejecting.

Another special technical feature:
 From Ø 31 mm (1-7/32"), we use specially hardened tool holders to compensate for the torsional power in case of heavy operation, which avoids early shearing off of the tool holder shank.
 In terms of construction not comparable with any other make.

MBS – for almost limitless use

e.g., on Rotabest Magnetic Drilling Machine (with MT2 or MT3 – arbors) and Weldon adaptor Prod.-No. 060WD on Machines with Weldon Shank.



ALFRA TCT-HOLE SAWS – MBS-PRO

Ø mm	Ø Inches	No. of teeth	Prod.-No.
Ø 18.0	11/16"	6	0760018
Ø 18.6		6	07600186
Ø 19.0	3/4"	6	0760019
Ø 20.0		6	0760020
Ø 20.4		6	07600204
Ø 21.0	13/16"	6	0760021
Ø 22.0		6	0760022
Ø 22.5		6	07600225
Ø 23.0	7/8"	6	0760023
Ø 24.0	15/16"	6	0760024
Ø 25.0		6	0760025
Ø 26.0	1"	6	0760026
Ø 27.0	1-1/16"	6	0760027
Ø 28.0		6	0760028
Ø 28.3		6	07600283
Ø 29.0	1-1/8"	6	0760029
Ø 30.0	1-3/16"	6	0760030

As from Ø 31.0 mm (1-7/32") we recommend the use of MT arbors

Ø 31.0		6	0760031
Ø 32.0	1-1/4"	6	0760032
Ø 33.0		6	0760033
Ø 34.0	1-5/16"	6	0760034
Ø 35.0	1-3/8"	6	0760035
Ø 36.0		6	0760036
Ø 37.0	1-7/16"	6	0760037
Ø 38.0		6	0760038
Ø 39.0	1-1/2"	6	0760039
Ø 40.0	1-9/16"	6	0760040
Ø 41.0		6	0760041
Ø 42.0	1-5/8"	6	0760042
Ø 43.0	1-11/16"	6	0760043
Ø 44.0		6	0760044
Ø 45.0	1-3/4"	6	0760045
Ø 46.0		6	0760046
Ø 47.0	1-13/16"	6	0760047
Ø 48.0	1-7/8"	6	0760048
Ø 49.0		6	0760049
Ø 50.0	1-15/16"	6	0760050
Ø 51.0	2"	6	0760051
Ø 52.0		6	0760052
Ø 53.0	2-1/16"	6	0760053
Ø 54.0	2-1/8"	6	0760054
Ø 55.0		6	0760055
Ø 56.0	2-3/16"	6	0760056
Ø 57.0	2-1/4"	6	0760057
Ø 58.0		6	0760058
Ø 59.0	2-5/16"	6	0760059
Ø 60.0	2-3/8"	8	0760060
Ø 61.0		8	0760061
Ø 62.0	2-7/16"	8	0760062
Ø 63.0		8	0760063
Ø 64.0	2-1/2"	8	0760064
Ø 65.0		8	0760065
Ø 66.0	2-9/16"	8	0760066
Ø 67.0	2-5/8"	8	0760067
Ø 68.0		8	0760068
Ø 69.0	2-11/16"	8	0760069
Ø 70.0	2-3/4"	8	0760070
Ø 71.0		10	0760071
Ø 72.0	2-13/16"	10	0760072
Ø 73.0	2-7/8"	10	0760076
Ø 74.0	2-15/16"	10	0760074
Ø 75.0		10	0760075

Ø mm	Ø Inches	No. of teeth	Prod.-No.
---------	-------------	-----------------	-----------

For drilling stainless steel from Ø 76.0 mm we recommend using Rotabest AL cutters (Prod.-No. 200207...)

Ø 76.0	3"	10	0760076
Ø 77.0		12	0760077
Ø 78.0	3-1/16"	12	0760078
Ø 79.0	3-1/8"	12	0760079
Ø 80.0		12	0760080
Ø 81.0	3-3/16"	12	0760081
Ø 82.0		12	0760082
Ø 83.0	3-1/4"	12	0760083
Ø 84.0	3-5/16"	12	0760084
Ø 85.0		12	0760085
Ø 86.0	3-3/8"	14	0760086
Ø 87.0	3-7/16"	14	0760087
Ø 88.0		14	0760088
Ø 89.0	3-1/2"	14	0760089
Ø 90.0	3-9/16"	14	0760090
Ø 91.0		14	0760091
Ø 92.0	3-5/8"	14	0760092
Ø 93.0		14	0760093
Ø 94.0	3-11/16"	14	0760094
Ø 95.0	3-3/4"	14	0760095
Ø 96.0		14	0760096
Ø 97.0	3-13/16"	14	0760097
Ø 98.0	3-7/8"	14	0760098
Ø 99.0		14	0760099
Ø 100.0	3-15/16"	14	0760100

HSS-Spare Drill

with tapered center tip 

from Ø 18.0 - 60.0	Ø 6x80 mm	0732680
from Ø 61.0 - 100.0	Ø 8x80 mm	0732880

MT Arbors



MT-2 (Ø 31.0 - 100.0 mm)	0734002
MT-3 (Ø 31.0 - 100.0 mm)	0734003

Weldon adapter



from Ø 31.0 mm	o6oWD
(incl. ejector pin Prod. No. 1950500)	

Spare Ejector

For tapered center drill

from Ø 15.2 - 60.0	Ø 6 mm	0762006
suitable for spare drill Ø 6 mm		

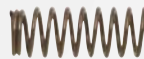

Drilling structured sheet metals



Drilling tubes



Drilling flat steels

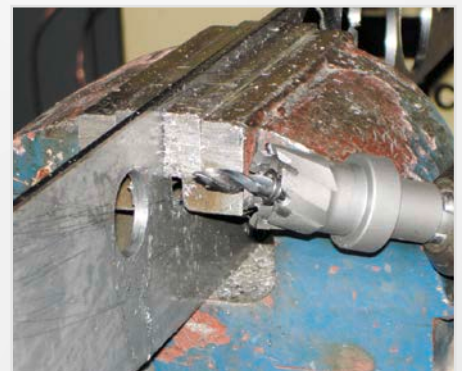

Free-hand drilling up to Ø 30 mm

ALFRA TCT-HOLE SAWS – FRP TYPE

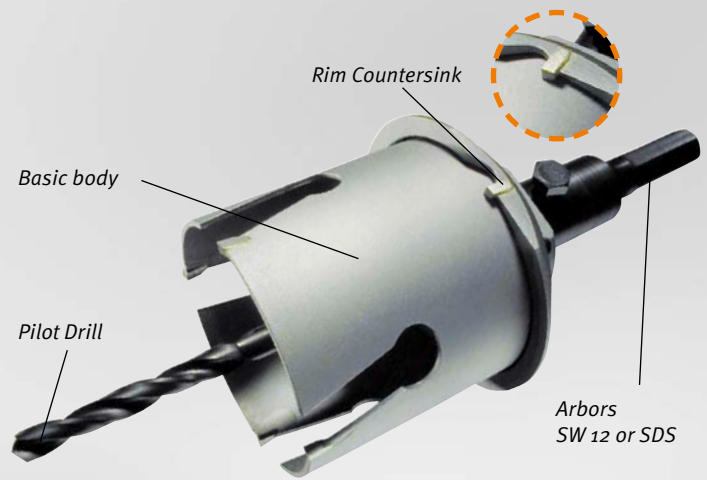
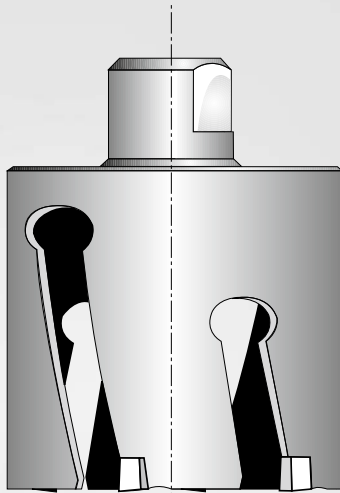

Prod.-No. 0740068060 – FRP Ø 68 mm with tool holder and rim countersink

Cutting depth 60 mm (2-3/8")

- Specially designed for wood, plain, laminated and coated chip board, plywood, paper-base laminate, PVC, glass fibre reinforced plastic, gas concrete, Ytong stone, plasterboard, hollow gauged brick/stones.
- No blocking due to optimal cutting geometry.
- Simple drill core removal based on new chip space design.
- In the event of a tooth breaking, it can easily be replaced and re-sharpened.
- Only use when rotating, switch off hammer action.
- Ideal for electricians, plumbers and heating engineers, carpenters and cabinet makers, stair construction and kitchen furniture fitters.



Perfect assembly of sockets in e.g. wood, gypsum plaster board,...



Rim countersink for Ø 68 mm 0741068000



Tool Holder wrench size 12 0742000001



Arbor SDS 0742000002

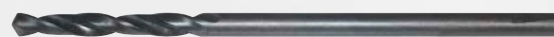

Spare center drill HSS 7.2 mm 0742000003

FRP Hole Saw Set Electrician

- Content: 0743000001
- 1 each of Ø 35 / 68 / 74 mm
 - 1 Tool Holder wrench size 12
 - 1 HSS drill

FRP Hole Saw Set Lighting

- Content: 0743000002
- 1 each of Ø 35 / 60 / 68 / 80 / 85 mm
 - 1 Tool Holder wrench size 12
 - 1 HSS drill

Ø mm	TCT-Hole Saws FRP inch single drill bit, cutting depth 60 mm	Prod.-No.
30.0	Sanitary and heating pipes	0740025060
35.0	Sanitary and heating pipes	0740030060
35.0	Cavity wall branch box, halogen reflector lamp	0740035060
40.0	Sanitary drain pipes	0740040060
45.0	Water and heating pipes	0740045060
50.0	with insulation 0740050060	0740050060
55.0	Recessed lights Ø 55 mm	0740055060
58.0	Recessed lights Ø 58 mm	0740058060
60.0	Recessed lights Ø 60 mm	0740060060
63.0	Switch box Ø 60 mm	0740063060
65.0	Cavity wall box Ø 65 mm	0740065060
68.0	Cavity wall box Ø 68 mm	0740068060
70.0	Cavity wall branch boxes Ø 70 mm	0740070060
74.0	Cavity wall branch boxes Ø 74 mm	0740074060
80.0	Junction boxes, cable gland covers, Recessed lights Ø 80 mm	0740080060
85.0	Recessed lights Ø 85 mm	0740085060
90.0	Recessed lights Ø 90 mm	0740090060
105.0	Discharge air pipes	0740105060

ALFRA HSS-BI-METAL HOLE SAWS

Features:

- High concentricity.
- With solid base plate, thus more threads and higher stability as well as concentric running exactness.
- For material from 2 mm – with positive chipping and cutting angles as well as combi-toothing 4/6 tpi. This variable spacing provides a more even cut, for a minor generation of vibrations and heat. Lower expenditure of energy when cutting.
- Cutting Depth: 38 mm (1-1/2").
- Lateral slots help to remove the core.
- Suitable for unalloyed steel (up to 700 N/mm²), nonferrous metals, light metals, plastics, gypsum, pulp wood- and plywood boards, lightweight building boards and general wood processing.
- Drill bit exchangeable with other commercially available arbors.



Also steel/stainless steel up to approx. 3 mm, can be worked easily (for frequent use, we recommend our TCT Hole Saws).



...designed to work on softwoods.



ALFRA – HSS-BI-METAL HOLE SAWS

ALFRA HSS-Bi-Metal Hole Saws are applicable in portable and pillar drilling machines. When using pillar drilling machines, use manual feed only.

Features:

- High concentricity.
- With solid base plate, thus more threads and higher stability as well as concentric running exactness.
- With positive chipping and cutting angles as well as combi-toothing 4/6 tpi. This variable spacing provides a more even cut, for a minor generation of vibrations and heat. Lower expenditure of energy when cutting.
- Cutting Depth: 38 mm (1-1/2").
- Lateral slots help to remove the core.
- Suitable for unalloyed steel (up to 700 N/mm²), nonferrous metals, light metals, plastics, gypsum, pulp wood- and plywood boards, lightweight building boards and general wood processing.
- Drill bit exchangeable with other commercially available arbors.

Tip:

Start drilling operation with light pressure. Continue with light and steady pressure, avoid pendulum motion, follow the speed chart, use coolant. When cutting wood or wood substitutes, remove drill dust in time.



Combi toothing 4/6 tpi



from Ø 14.0 to 210 mm available

Saw-Ø mm	Inches	Prod.-No.
14.0	9/16"	0500014
16.0	5/8"	0500016
17.0	11/16"	0500017
19.0	3/4"	0500019
20.0	15/19"	0500020
21.0	13/16"	0500021
22.0	7/8"	0500022
24.0	15/16"	0500024
25.0	1"	0500025
27.0	11/16"	0500027
29.0	1-1/8"	0500029
30.0	1-3/16"	0500030
32.0	1-1/4"	0500032
33.0	1-5/16"	0500033
35.0	1-3/8"	0500035
37.0	1-7/16"	0500037
38.0	1-1/2"	0500038
40.0	1-9/16"	0500040
41.0	1-5/8"	0500041
43.0	1-11/16"	0500043
44.0	1-3/4"	0500044
46.0	1-13/16"	0500046
48.0	1-7/8"	0500048
51.0	2"	0500051
52.0	2-1/16"	0500052
54.0	2-1/8"	0500054
57.0	2-1/4"	0500057
59.0	2-5/16"	0500059
60.0	2-3/8"	0500060
64.0	2-1/2"	0500064
65.0	2-9/16"	0500065
67.0	2-5/8"	0500067
68.0	2-11/16"	0500068
70.0	2-3/4"	0500070
73.0	2-7/8"	0500073



ALFRA – HSS BI-METAL HOLE SAWS

Saw Ø mm	Inches	Prod.-No.
74.0	2-11/12"	0500074
76.0	3"	0500076
79.0	3-1/8"	0500079
83.0	3-1/4"	0500083
86.0	3-3/8"	0500086
89.0	3-1/2"	0500089
92.0	3-5/8"	0500092
95.0	3-3/4"	0500095
98.0	3-7/8"	0500098
102.0	4"	0500102
105.0	4-1/8"	0500105
108.0	4-1/4"	0500108
111.0	4-3/8"	0500111
114.0	4-1/2"	0500114
121.0	4-3/4"	0500121
127.0	5"	0500127
140.0	5-1/2"	0500140
152.0	6"	0500152

From Ø 160.0 mm only suitable for wood and wood substitutes.

160.0	6-5/16"	0500160
168.0	6-10/16"	0500168
177.0	7"	0500177
210.0	8-5/16"	0500210

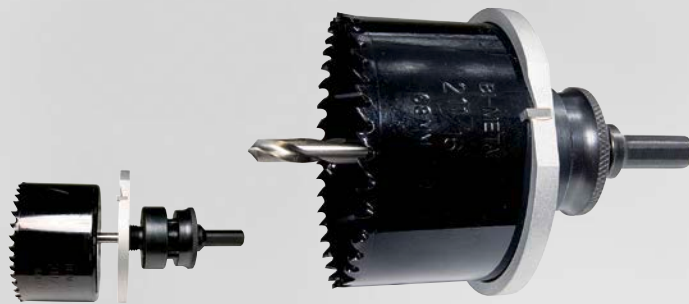

Prod.-No. 0501013 with bi-metal hole saw Ø 68 mm + A2-SS

Arbors

with pilot drill

Saw-Ø mm	Saw-Ø inch	Type	Shank-Ø	Prod.-No.
14 - 30	9/16" - 1-3/16"	A 6-SS	9.5 hexago	0501001
14 - 30	9/16" - 1-3/16"	A 6-SDS	SDS	0501002
32 - 152	1-1/4" - 6"	A 2-SS	9.5 hexago	0501003
32 - 152	1-1/4" - 6"	A 2-SDS	SDS	0501005
32 - 210	1-1/4" - 8-5/16"	A 3-SS	11.11 hexago	0501006
32 - 210	1-1/4" - 8-5/16"	A 5-SS	16.0 hexago	0501008

Accessories:

Rim countersink for Ø 68 mm (with TCT-teeth)	0501013
Extension shaft 300 mm x 9.5 mm for A 6-SS + A 2-SS, A3-SS	0501010
Spare Center Drill HSS Ø 6.35 mm x 80 mm for A 6-SS + A 6-SDS + A 2-SS + A 2-SDS + A 3-SS + A 5-SS	0502001
Ejector Spring	0502004

Important: Disable impact drill position when using SDS-shanks!

9.5 mm
3/8"

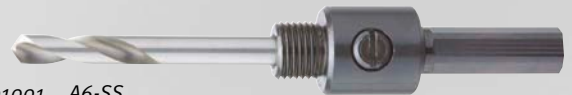

Prod.-No. 0501001 A6-SS

SDS plus



Prod.-No. 0501002 A6-SDS

9.5 mm
3/8"



Prod.-No. 0501003 A2-SS

SDS plus



Prod.-No. 0501005 A2-SDS

11.11 mm
7/16"



Prod.-No. 0501006 A3-SS



Prod.-No. 0501013



Diverse applications

Prod.-No. 0501010



Prod.-No. 0502001

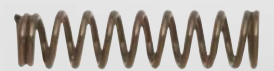

Prod.-No. 0502004

ALFRA – HSS BI-METAL HOLE SAW SETS

HSS Bi-Metal Hole Saw Sets



■ The following HSS-Bi-Metal Hole Saw Sets enlarge our range. These sets were especially compiled for electricians, mechanics, plumbers and for general, universal applications.

■ All sets are delivered in a robust and practical plastic case

■ Incl. Arbor A6-SS, Arbor A2-SS, Spare Twist Drill

■ These sets improve the presentation. Storage in solid tool cases.

Ø mm	16.0	19.0	22.0	24.0	25.0	29.0	32.0	35.0	38.0	44.0	51.0	52.0	57.0	64.0	67.0	68.0	76.0
Ø Inch	5/8"	3/4"	7/8"	15/16"	1"	1-1/8"	1-1/4"	1-3/8"	1-1/2"	1-3/4"	2"	2-1/16"	2-1/4"	2-1/2"	2-5/8"	2-11/16"	3"

Prod.-No.	Hole Saw Set Standard																
0503006	●	●	●			●		●		●		●	●		●		
Prod.-No.	Hole Saw Set Professional																
0503007	●	●	●		●	●	●	●	●	●	●			●			●
Prod.-No.	Hole Saw Set Electro																
0503008			●			●		●		●	●			●		●	
Prod.-No.	Hole Saw Set Sanitary																
0503009	●	●		●		●			●	●			●		●		

MULTI-STEP DRILLS – HSS DM 05

Application area:

The ideal tool for sheet metal forming, for the electrical industry, HVAC or the common engineering or the switchboard industry.

Suitable for all materials such as nonferrous metals, stainless steel sheets, thermoplastic and thermosetting plastics, as well as for steel sheets up to a max. material thickness of 6 mm.

With the Multi-Step Drills, sheet metals can be centered, drilled and subsequently deburred in one work step.

- A break of the drill tip mostly occurs through high feed forces at the start of the drilling operation. Multi-step drills with fixed drill tips are worthless then. A broken center drill in an ALFRA multi-step drill can be easily replaced. This more than compensates for the higher price.
- Each stage is equipped with a radially adjusted relief grinding corresponding to its diameter.
- Each stage is provided with an axial relief grinding and a relief angle on its cutting edge.
- All step diameters are laser marked on the tool.

Benefits of multi-step drills with keyway and 3 cutting edges:

- The keyway allows the drill to make a chipping cut during drilling for better chip removal.
- The special keyway geometry, arranged around the drill, makes for a longer cutting edge compared to the usual straight groove and noticeably easier cutting.
- Spiral cut chip spaces guarantee an absolute running smoothness and a high cutting capacity.

Tip:

The tool life can be considerably prolonged by using of ALFRA Cutting Spray or ALFRA Coolant Stick.

Advantages of TiAlN hard coating:

- Suitable for use on very hard materials (VA).
- Offers optimal tool life with the same use at the highest cutting speeds.
- Very high microhardness HV 0.05 of 3200 – so that the blue-black hard coating is more than 20% harder than conventional gold-yellow TiN coating.
- Maximum working temperature: 800°C.

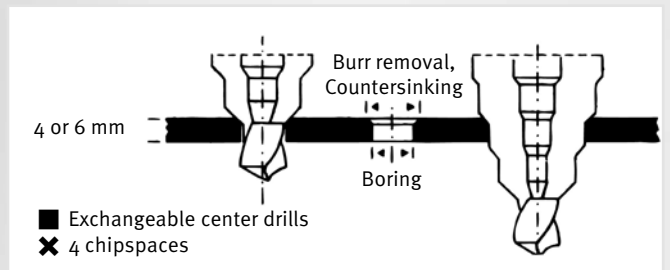

DescriptioShank Ø

AMS	10.0	Prod.-No. 08080
-----	------	-----------------

For general machine construction, drills circular holes in metals up to 4 mm thick, through application with hand drills, indispensable on the work-site. 3 chip spaces, spiral grooved, replaceable center drill
Steps Ø 9 - 12 - 15 - 18 - 21 - 24 - 27 - 30 - 33 - 36 mm (Step "40" is for deburring)

AMS – TiAlN coated	10.0	08081
--------------------	------	-------

3 chip spaces, spiral grooved, replaceable center drill TiAlN coated
Steps Ø 9 - 12 - 15 - 18 - 21 - 24 - 27 - 30 - 33 - 36 mm (Step "40" is for deburring)

AM 1	12.0	08002
------	------	-------

Steps Ø 25 - 28 - 31 - 34 - 37 - 40 - 43 - 46 - 49 - 52 - 55 - 58 mm

PVD	10.0	08003
-----	------	-------

For the **electrical industry**, matched to holes for armoured conduit thread clearance holes, saves considerable time when producing borings for PG
Steps Ø PG 7 - PG 9 - PG 11 - PG 13 - PG 16 - PG 21 - 33 mm - PG 29 - 40 mm



Prod.-No. 08080 ■



Prod.-No. 08081 ■



Prod.-No. 08002 ■ ✗



Prod.-No. 08003 ■ ✗

MULTI-STEP DRILLS – HSS DM 05

DescriptioShank Ø		Prod.-No.
PVD-TiN-coated	10.0	08004
Steps Ø PG 7 – PG 9 – PG 11 – PG 13 – PG 16 – PG 21 – 33 mm – PG 29 – 40 mm		

SVB	10.0	08016
Pre-drill specifically for punches & dies Steps Ø 8.5 - 11.5 - 12.5 - 16.5 - 21.0		

DKS 40	10.0	08084
3 chip spaces, spiral grooved, replaceable center drill, for metric borings acc. to EN, Core - and clearance holes M 10 - M 40 Steps Ø 10.5 - 12.5 - 14.5 - 16.5 - 18.5 - 20.5 - 23.5 - 25.5 - 32.5 - 38.5 - 40.5		

DKI 40-VA	10.0	08032
4 chip spaces, replaceable center drill of HSS-Co 5 steel. For stainless steel to 3 mm thick Core - and clearance holes M 10 - M 40 Steps Ø 10.5 - 12.5 - 14.5 - 16.5 - 18.5 - 20.5 - 23.5 - 25.5 - 32.5 - 38.5 - 40.5		

Spare center drill TiN-beschichtet	08006
suitable for AMS – PVD – PVK – DKI – DKS	

Spare center drill	08007
suitable for AMS – PVD – PVK – DKI – DKS	

Spare center drill TiAlN coated	08008
suitable for AMS – PVD – PVK – DKI – DKS	



Prod.-No. 08004 ■ X



Prod.-No. 08016



Prod.-No. 08084 ■

Pre-drill specifically
for punches & dies



Prod.-No. 08032 ■ X



Prod.-No. 08007



Prod.-No. 08008

■ Replaceable center drill
X With 4 chip spaces

MULTI-STEP DRILLS – HSS DM 05

Standard execution with 2 chip spaces, spiral grooved.

- More precise hole diameter through cylindrical steps.
- Immediate deburring through the next step.
- Drilling of sheet metals as thin as 4 mm possible.
- Use coolant stick!
- The keyway allows the drill to make a chipping cut during drilling for better chip removal.
- Longer cutting edge compared to the usual straight groove and noticeably easier cutting.
- Laser-etched scale in the chip space to indicate the bore diameter achieved.

Descriptio	Bore range	Shank Ø	Length	Prod.-No.
AM-12	4 - 12 mm x 1 mm	6.0	70 mm	08070
AM-20	4 - 20 mm x 2 mm	9.0	77 mm	08071
AM-30	6 - 30 mm x 2 mm	10.0	98 mm	08072

Set in plastic case 08073

Content:
1 of each Type AM-12/AM-20/AM-30

High-performance coolant stick 09012



Prod.-No. 08072



Prod.-No. 09012

Standard values for the use of ALFRA Multi-step drills

This drill was developed to bore perfectly round and deburred holes in sheet metal from 4 - 6 mm thick. The transition forms a radius which serves to deburr or bevel the hole at the same time. While conical one-lip bits drill a slightly tapered hole, our ALFRA multi-step drill achieves a cylindrical hole. The tools have axial-radial relief grindings and can be lightly reground on the breast of the cutting tooth.

We recommend the use of pillar drilling machines, however, the small ALFRA Multi-step drills can be used on adjustable hand drilling machines. Sufficient cooling using **ALFRA coolant stick** or a bore emulsion is imperative.

R.P.M. Guiding Values

Type	sheet steel S235	V2A sheets	non-ferrous metals	plastics (soft)
AM	drill 800	360	1000	1000
	countersink 500 - 180	50 - 70	800 - 400	1000 - 400
AM-1	drill 800	360	1000	1000
	countersink 200 - 100	100 - 50	500 - 200	600 - 250
PVD+PVK+DKI	drill 800	360	1000	1000
DKS + SVB	countersink 400 - 200	200 - 100	800 - 500	1000 - 600

Prod.-No. 08073



PRECISION CONICAL ONE-LIP BITS – HSS DM 05

ALFRA Precision Conical One-Lip Bits are the ideal tools for general sheet metal working. Fields of applications include HVAC, electronic industries, engineering and panel building.

To be used on non-ferrous metals, stainless steels, thermo- and duro-plastic plastics, as well as on all common sheet steels up to a material thickness of max. 4 mm. With ALFRA Conical One-Lip Bits, you can center, spot drill and bore up in one work step.

If treated carefully, can be reground many times.

The tool life can considerably be prolonged by using ALFRA Cutting Oil or Coolant Stick.

Packing: separately in plastic box with operation manual.

Size	Bore Range mm	Shank-Ø	Prod.-No.
1	3.0 - 14.0	6.0	09001
2	6.0 - 20.0	8.0	09002
3	16.0 - 30.5	10.0	09003
4	26.0 - 40.0	12.0	09004
5	35.0 - 50.0	12.0	09005
6	46.0 - 60.0	13.0	09006
7 L	4.0 - 30.5	10.0	09007
8*	6.0 - 22.5	8.0	09008
Set 1	Size 1 + 2 + 3 + Stick		09009

Coolant stick, separately **09012**

*Special Antenna-Bit

- Conical one-lip bit with cylindrical end section to drill holes for car antennas.
- Burr-free, no deformation, no countersinking, dimensional accuracy
- Size 6.0 - 22.5 mm.

Precision Conical One-Lip Bit Set

Prod.-No.
09009

Tin box

Content:

- 1 x Size 1
- 1 x Size 2
- 1 x Size 3



Prod.-No. 09001



Prod.-No. 09002



Prod.-No. 09003



Prod.-No. 09004



Prod.-No. 09005



Prod.-No. 09006



Prod.-No. 09007



Prod.-No. 09008*



Prod.-No. 09009

ALFRA SABRE SAW BLADES FOR PROFESSIONAL USE

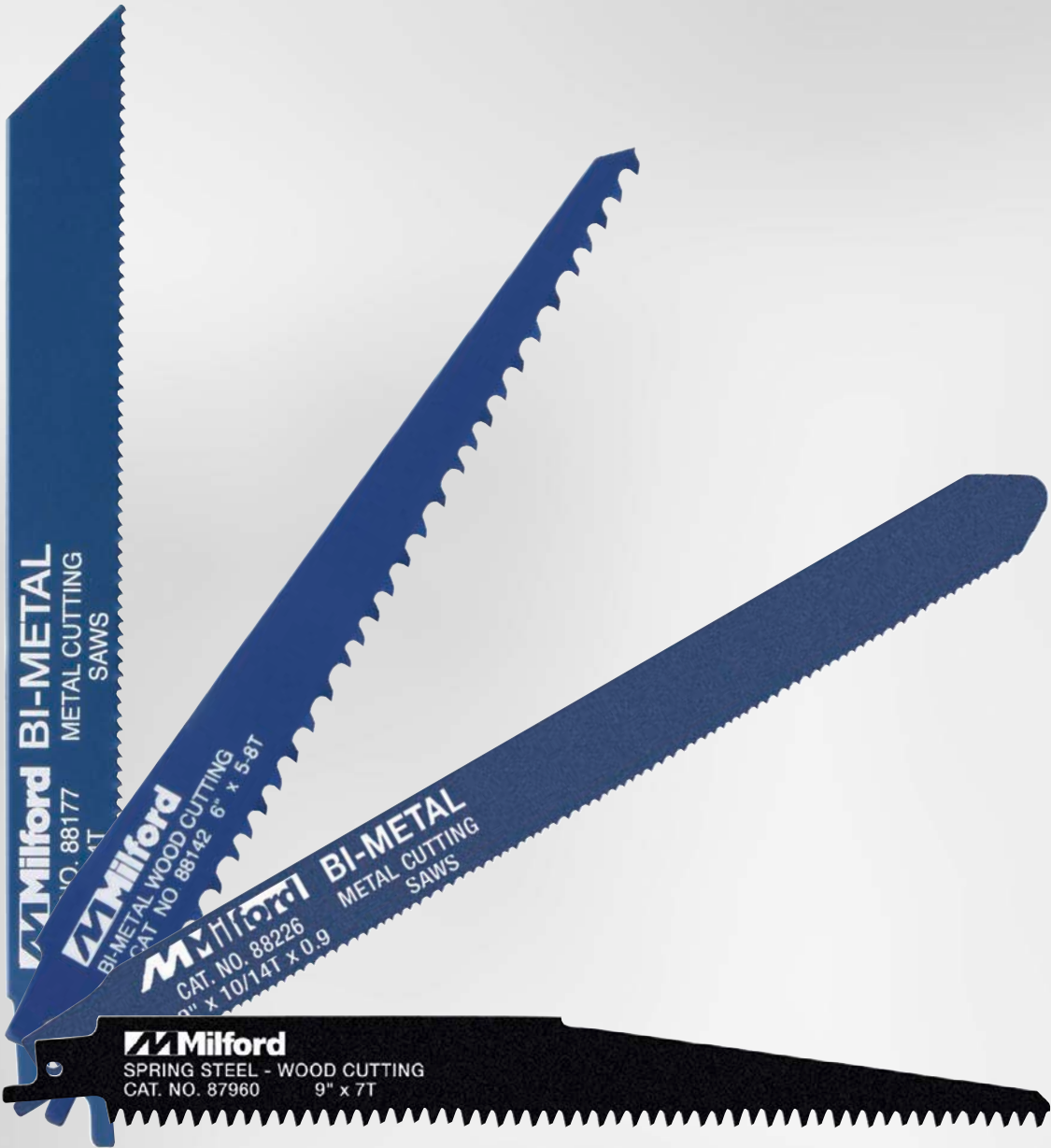

ORIGINAL MILFORD SABRE SAW BLADES – EXKLUSIVE BY ALFRA

for Metal flexible version



Application Range Metal processing	Material thickness mm	Steel- Quality	Length	Width	Thickness	Teeth Inch	Milford Prod.-No.	Alfa Prod.-No.
Metal processing; soft metals, Copper-, aluminium-, brass-cables, wires and pipes	3 mm	HSS-Bi-Metal	100 mm	16 mm	0.9 mm	14	88161	30055
Metal processing; soft metals, Plastic, laminate and wood with nails	> 3 mm	HSS-Bi-Metal	150 mm	16 mm	0.9 mm	8/12	88215	30040
All kind of metals, stainless steel, Steel pipes, cast iron, alloys, etc.	> 6 mm	HSS-Bi-Metal	150 mm	16 mm	0.9 mm	10	88176	30058
All kind of metals, stainless steel, Steel pipes, cast iron, alloys, etc.	> 3 mm	HSS-Bi-Metal	150 mm	16 mm	0.9 mm	14	88177	30059
All kind of metals, stainless steel, Steel pipes, cast iron, alloys, etc.	> 1.15 mm	HSS-Bi-Metal	150 mm	16 mm	0.9 mm	18	88178	30060
All kind of metals, stainless steel, Steel pipes, cast iron, alloys, etc. With universal tothing	3-6 mm	HSS-Bi-Metal	150 mm	16 mm	0.9 mm	10/14	88216	30062
Metal processing; soft metals, Plastic, laminate and wood with nails	> 3 mm	HSS-Bi-Metal	225 mm	16 mm	0.9 mm	8/12	88219	30041
All kind of metals, stainless steel, Steel pipes, cast iron, alloys, etc.	> 6 mm	HSS-Bi-Metal	225 mm	16 mm	0.9 mm	10	88174	30063
All kind of metals, stainless steel, Steel pipes, cast iron, alloys, etc.	> 3 mm	HSS-Bi-Metal	225 mm	16 mm	0.9 mm	14	88186	30064
All kind of metals, stainless steel, Steel pipes, cast iron, alloys, etc.	> 1.15 mm	HSS-Bi-Metal	225 mm	16 mm	0.9 mm	18	88187	30065
All kind of metals, stainless steel, Steel pipes, cast iron, alloys, etc. With universal tothing	3-6 mm	HSS-Bi-Metal	225 mm	16 mm	0.9 mm	10/14	88217	30066
All kind of metals, stainless steel, Steel pipes, cast iron, alloys, etc. With universal tothing	> 6 mm	HSS-Bi-Metal	290 mm	16 mm	0.9 mm	10/14	88218	30072



Metal processing; soft metals,
plastic, laminate an wood with nails –
particular for pallets



HSS-Bi-Metal 228 mm 19 mm 0.9 mm 10/14 88226 30045

ORIGINAL MILFORD SABRE SAW BLADES – EXKLUSIVE BY ALFRA

For Wood



Application Range Meta processing	Material	Steel-	Length	Width	Thickness	Teeth	Milford	Alfra
Special sabre saw for wood with nails; plasterboard In particular for the refurbishing		HSS-Bi-Metal	150 mm	19 mm	0.9 mm	5/8	88142	30085
Special sabre saw for wood Plastics or Laminates -curve sections-		HSS-Bi-Metal	150 mm		0.9 mm	4/6	88143	30086
Special sabre saw for wood, plasterboard In particular for the refurbishing		HSS-Bi-Metal	210 mm	19 mm	0.9 mm	6	88144	30087
Special sabre saw for wood, plasterboard In particular for the refurbishing		HSS-Bi-Metal	290 mm	19 mm	0.9 mm	6	88145	30088

For wood (coated)



Special sabre saw for wood With a special lamination for minimum frictio		HSS-Bi-Metal	228 mm	19 mm	1.0 mm	7	87960	30031
---	--	--------------	--------	-------	--------	---	-------	-------

TCT TOOLS – TECHNICAL TERMS

Clearance angle

is the angle between the carbide teeth and the material to be machined. ALFRA TCT core drills have several clearance angles on a cutting edge.

Cutting depth

is the maximum material thickness that can be machined with the respective tool (should not be confused with the construction height of the tool).

Chip flute

gathers up the chips generated or removes these from the borehole.

Chip breaker

directs the chips from the carbide tooth into the chip flute.

Cutting face

the chip is formed on this surface.

Angle of rake

is the angle between the tool axis and the cutting face.

Tooth projection

is the carbide projection to the core.

Tooth height difference

is used for the chip splitting.

Speed, cutting speed and feed rate (typical values)

Rotabest®- TCT hole cutters

Not suitable for automatic feed

Material	m/min	mm/r
Construction steel 50 kp/m ²	40-60	0.08-0.12
Steel 50-70 kp/m ²	30-50	0.08-0.12
Stainless steel	18-45	0.8-0.10
Cast iron	65-95	0.12-0.20
Non-ferrous metals, aluminium	100-550	0.22-0.45
Exotic alloys	10-30	0.05-0.08

Accuracy (reference value) / Input / + 0.10 mm Output / ± 0 mm

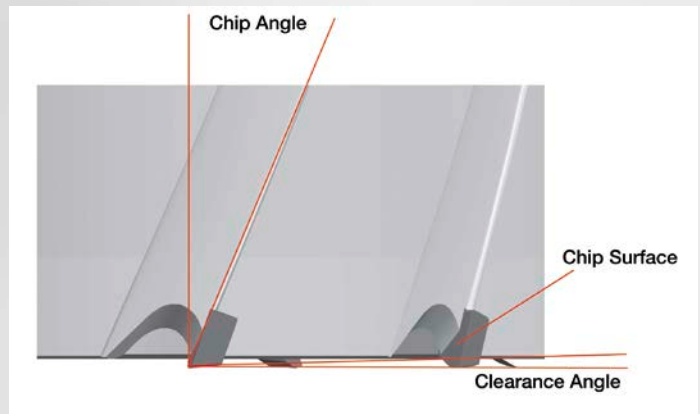

TCT-HOLE SAWS – SPEED CHART

Speed calculation

n = Speed (1/min)

v_c = Cutting Speed (m/min)

d = Tool diameter (mm)

$$n = \frac{v_c \times 1000}{d \cdot \pi}$$

Worked sample:

d = 20 mm

v_c = 50 m/min

$$n = \frac{50000}{20 \cdot \pi} = 795,77 \text{ 1/min}$$

Tool Ø	Cutting speed m/min													
	Stainless steel material							Mild steel - ST material						
	20	25	30	35	40	45	50	55	60	65	70	75	80	
16	398	498	597	697	796	896	995	1095	1194	1294	1393	1493	1592	
18	354	442	531	619	708	796	885	973	1062	1150	1238	1327	1415	
20	318	398	478	557	637	717	796	876	955	1035	1115	1194	1274	
22	290	362	434	507	579	651	724	796	869	941	1013	1086	1158	
24	265	332	398	464	531	597	663	730	796	863	929	995	1062	
26	245	306	367	429	490	551	612	674	735	796	857	919	980	
28	227	284	341	398	455	512	569	626	682	739	796	853	910	
30	212	265	318	372	425	478	531	584	637	690	743	796	849	
32	199	249	299	348	398	448	498	547	597	647	697	746	796	
34	187	234	281	328	375	422	468	515	562	609	656	703	749	
36	177	221	265	310	354	398	442	487	531	575	619	663	708	
38	168	210	251	293	335	377	419	461	503	545	587	629	670	
40	159	199	239	279	318	358	398	438	478	518	557	597	637	
42	152	190	227	265	303	341	379	417	455	493	531	569	607	
44	145	181	217	253	290	326	362	398	434	470	507	543	579	
46	138	173	208	242	277	312	346	381	415	450	485	519	554	
48	133	166	199	232	265	299	332	365	398	431	464	498	531	
50	127	159	191	223	255	287	318	350	382	414	446	478	510	
52	122	153	184	214	245	276	306	337	367	398	429	459	490	
54	118	147	177	206	236	265	295	324	354	383	413	442	472	
56	114	142	171	199	227	256	284	313	341	370	398	427	455	
58	110	137	165	192	220	247	275	302	329	357	384	412	439	
60	106	133	159	186	212	239	265	292	318	345	372	398	425	
62	103	128	154	180	205	231	257	283	308	334	360	385	411	
64	100	124	149	174	199	224	249	274	299	323	348	373	398	
66	97	121	145	169	193	217	241	265	290	314	338	362	386	
68	94	117	141	164	187	211	234	258	281	304	328	351	375	
70	91	114	136	159	182	205	227	250	273	296	318	341	364	
72	88	111	133	155	177	199	221	243	265	288	310	332	354	
74	86	108	129	151	172	194	215	237	258	280	301	323	344	
76	84	105	126	147	168	189	210	230	251	272	293	314	335	
78	82	102	122	143	163	184	204	225	245	265	286	306	327	
80	80	100	119	139	159	179	199	219	239	259	279	299	318	
82	78	97	117	136	155	175	194	214	233	252	272	291	311	
84	76	95	114	133	152	171	190	209	227	246	265	284	303	
86	74	93	111	130	148	167	185	204	222	241	259	278	296	
88	72	90	109	127	145	163	181	199	217	235	253	271	290	
90	71	88	106	124	142	159	177	195	212	230	248	265	283	
92	69	87	104	121	138	156	173	190	208	225	242	260	277	
94	68	85	102	119	136	152	169	186	203	220	237	254	271	
96	66	83	100	116	133	149	166	182	199	216	232	249	265	
98	65	81	97	114	130	146	162	179	195	211	227	244	260	
100	64	80	96	111	127	143	159	175	191	207	223	239	255	



FRP Hole Saws

Ø mm	Timber Chipboard	Plastics	Masonry	Wall tiles*
25/30/35	1000	800	800	500
40/45/50	800	600	700	400
58 bis 74	600	400	600	400
80/105	400	300	300	300

* Drilling in tiles only up to a scratch hardness of 6, mark centre, set the centre drill and drill through the glaze with at a low speed, allow the saw teeth to penetrate the glazing uniformly, running as smoothly and level as possible, so that the edge of the hole is made without chipping. Continue drilling at a normal drilling speed. Tiles with a scratch hardness greater than 6 may only be cut with diamond or carbide hole saws.

Notes on use

- Use rotation only. Switch off impact or hammer drill.
- Impact and shock on the sharp, ground carbide cutters can lead to small carbide splinters and thus to a severe loss of performance.
- Do not tilt the hole saw in the hole.
- Remove the drill core after each operation. Remove the sawdust when drilling timber and timber products.

Notes on use

For multipurpose hole saw with rim countersink

- The rim countersink is placed between hole saw and adapter and the carbide cutter is used to make a countersink in timber and timber substitutes. This makes it possible to fit sockets flush.

Important notes on use

- The hole saw with rim countersink may not be stopped before it is removed.
- Advance with care, to prevent the cut edges tearing.

HSS BI METAL HOLE SAWS – NOTES ON USE

1. Use the hole saws at the recommended cutting speed, see guide table on the packaging.
2. Do not apply excess pressure. Apply a little more pressure for a harder material and less pressure for a softer material.
3. In order to achieve good centring, the centre drill must project approximately 6 mm beyond the teeth. It is recommended that the hole is first predrilled with a twist drill and then the centre drill is used in the adapter as a centring pin.
4. Use a good cutting oil when drilling metal. This extends the hole saw's service life and prevents premature blunting of the tooth tips.
5. The arbor of the adapter must be firmly clamped with the flattened sides correctly seated in the chuck.
6. The hole saw must cut into the workpiece at a right angle. Avoid tilting. Risk of accident.
7. If large hole saw diameters are used in hand-held drills, the hand-held drill must be held particularly firmly. A drill stand should be used where possible.
8. The adapter must be firmly screwed into the hole saw with all its thread and the driver pins must be firmly seated in the driver holes.
9. Secure the driver pins with the rotating ring or lock in the case of a quick-change adapter.
10. Wear protective goggles when working with the bi-metal hole saws and keep hands away in case saw runs out. Never attempt to stop with your hands a saw that is running off.
11. Lift the saw clear frequently, especially when cutting timber, chipboard and wood substitutes and remove the sawdust and chips. If this is not done, the tooth tips can burn and the hole saw will jam in the cut.
12. We recommend the following procedure when drilling timber, chipboard and wood substitutes:

Drill a number of holes immediately inside the cut. This helps carry the chips away and avoids frequent interruptions in cutting to clean the tooth tips.

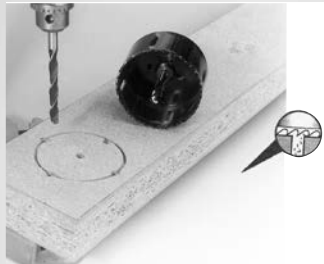

If the workpiece is especially thick...

...it is also recommended that you cut from both sides, or drill a number of holes immediately inside the circular cut. This helps carry the chips away and avoids frequent interruptions in cutting to clean the tooth tips.

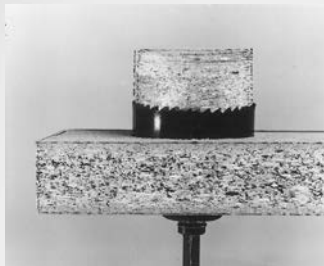

Enlarging existing holes

Existing holes 32 mm (1-1/4") or more in diameter may be enlarged with a simple trick:



Take a 32 mm diameter hole saw and screw this inside the hole saw on the projecting thread of the A2 adapter. The inner hole saw then acts as a kind of guiding hole saw for extending existing holes, see photo.

What you absolutely must avoid:

1. Drilling at too fast or too slow a cutting speed. The teeth will glide over the material and become prematurely blunt.
2. Avoid bringing the saw teeth abruptly down on the workpiece, the teeth will break off.
3. Never cut metallic materials dry. Always use a cutting oil.
4. Never bring the saw up to the workpiece on a slant. There is a risk of injury when hand drills are used. The saw can break up or the arbor could be damaged.
5. Ensure that the hole saw is running true. Check the chuck as necessary.
6. Never screw the adapter's guide pins only partially into the hole saw guide holes. The thread of the hole saw could be torn out.
7. Never regrind the hole saw freely by hand. Have hole saws reground by a specialist. Care must be taken to ensure sufficient residual setting and a uniform tooth height.
8. If the tool arbor is pushed into the chuck or if the arbor shears off, the advance pressure is too great.
9. If the hole saw is unevenly worn on the outside, then the saw is not running true or the material to be sawn was not correctly clamped.
10. If the tooth tips are blued, the saw has been used without cutting oil, or at too high a cutting speed.

HSS BI-METAL HOLE SAWS – SPEED CHART

Diameter mm	Mild Steel	Cast Iron	Tool steel + stainless steels	Brass	Aluminium	Wood
14	580	400	300	790	900	3000
16	550	365	275	730	825	3000
17	500	330	250	665	750	3000
19	460	300	230	600	690	3000
20	440	290	220	580	660	3000
21	425	280	210	560	635	3000
22	390	260	195	520	585	3000
24	370	245	185	495	555	3000
25	350	235	175	470	525	2700
27	325	215	160	435	480	2700
29	300	200	150	400	450	2700
30	285	190	145	380	425	2400
32	275	180	140	380	410	2400
33	260	175	135	345	390	2400
35	250	165	125	330	375	2400
37	240	160	120	315	360	2400
38	230	150	115	300	345	2400
40	220	145	110	290	330	2100
41	210	140	105	280	315	2100
43	205	135	100	270	305	2100
44	195	130	95	260	295	2100
46	190	125	95	250	285	2100
48	180	120	90	240	270	2100
51	170	115	85	230	255	2000
52	165	110	80	220	245	2000
54	160	105	80	210	240	2000
57	150	100	75	200	225	2000
59	145	100	75	195	225	2000
60	140	95	70	190	220	2000
64	135	90	65	180	205	1800
65	130	85	65	175	200	1800
67	130	85	65	170	195	1800
70	125	80	60	160	185	1800
73	120	80	60	160	180	1800
76	115	75	55	150	170	1500
79	110	70	55	140	165	1500
83	105	70	50	140	155	1500
86	100	65	50	130	150	1200
89	95	65	45	130	145	1200
92	95	60	45	120	140	1200
95	90	60	45	120	135	1200
98	90	60	45	120	135	1200
102	85	55	40	110	130	1000
105	80	55	40	110	120	1000
108	80	55	40	110	120	900
111	80	50	40	100	120	900
114	75	50	35	100	105	900
121	75	50	35	95	95	900
127	65	45	30	90	90	800
133	60	40	25	86	85	800
140	60	40	25	85	85	800
146	55	35	25	75	75	800
152	55	35	25	75	75	800



These speeds are benchmarks. The speed can be higher or lower, this depends on the material type and the cutting behaviour.

Attention: Do not use cutting oil, if you are cutting cast iron. If you are cutting aluminium use paraffin wax or paraffin.

Calculation of the Cutting Speed

n = Speed (1/min)

v_c = Cutting speed (m/min)

d = Tool diameter (mm)

$$v_c = \frac{\pi \times d \times n}{1000}$$

SPEED CHART – MULTI-STEP DRILLS/CONICAL ONE-LIP BITS

ALFRA-Multi-step drills

These drills were especially to drill perfectly round and simultaneously deburred holes in sheet metals of 3 - 6 mm. The radius transition simultaneously deburrs or bezeles the holes. While conical one-lip bits drill slightly conical holes, cylindrical holes can be drilled with ALFRA Multi-step drills. The tools are axial-radially relief ground and can be resharpened at the breast of the cutting tooth.

We recommend the use of pillar drilling machines, however, the small ALFRA Multi-step drills can be used on adjustable hand drilling machines.

Imperatively use sufficient cooling (**ALFRA coolant stick or bore emulsion**).

Type		Stahl-blech S235	V2A Bleche	NE-Metalle	Kunststoff weich
AM	anbohren	800	360	1000	1000
	aufsenken	500 - 180	50 - 70	800 - 400	1000 - 400
AM-1	anbohren	800	360	1000	1000
	aufsenken	200 - 100	100 - 50	500 - 200	600 - 250
PVD, PVK, DKI PVD-VA + SVB	anbohren	800	360	1000	1000
	aufsenken	400 - 200	200 - 100	800 - 500	1000 - 600

ALFRA HSS DM 05 Precision Multi-step drills

- Take notice of the cutting speed
- Grease the cutting lips in case of application

The holes are deburred on both sides by the multistep drills. The multistep drill drills holes in thin materials, enlarges existing holes, makes inclined holes, drills pipes, makes holes penetrating each other. Suitable for any hand drill. For steel – PVC – polystrol – polyester – Plexiglas – card – plywood and similar materials. Can be reground many times, if treated carefully.

Material	unalloyed Mild steel 700 N/mm ²	Mild steel 1000 N/mm ²	Alloy steel > 250 N/mm ²	Stainless steel < 1000 N/mm ²	Al. alloy up to 11% Si	Thermo-plastic	Duro-plastic	Wood
Material gauge	4.0 mm X	4.0 mm X	4.0 mm X	3.0 mm X	4.0 mm X	4.0 mm H ₂ O	4.0 mm Air	25.0 mm
Drilling paste	20 - 25	10 - 16	8 - 12	5 - 12	10 - 16	12 - 25	8 - 12	40 - 100
Ø mm	U/min	U/min	U/min	U/min	U/min	U/min	U/min	U/min
3.0 - 14.0	2600 - 600	2100 - 450	1060 - 230	500 - 300	2600 - 550	2100 - 450	1500 - 340	3000 - 1000
6.0 - 20.0	1500 - 400	1200 - 320	640 - 160	400 - 250	1590 - 400	1270 - 320	950 - 240	2800 - 1000
6.0 - 22.5	1500 - 250	1200 - 280	640 - 140	400 - 250	1500 - 350	1270 - 280	950 - 210	2000 - 800
16.0 - 30.0	300 - 200	400 - 210	200 - 100	150 - 80	500 - 260	400 - 210	300 - 160	1500 - 800
26.0 - 40.0	330 - 200	270 - 160	130 - 80	100 - 60	330 - 200	270 - 160	200 - 120	1000 - 400
36.0 - 50.0	220 - 160	180 - 130	90 - 60	80 - 40	220 - 160	180 - 130	130 - 100	600 - 200
46.0 - 60.0	200 - 130	160 - 100	80 - 50	40 - 20	200 - 130	160 - 100	120 - 80	500 - 100

Copyright by Alfra GmbH
2020

All technical data, descriptions and illustrations contained in this catalogue are not binding. We reserve the right to make changes in the course of the further development of the products.

We accept no liability for printing errors.

Through publication of this catalogue all previous catalogues become invalid.

As of March 2020

All rights reserved.

This catalogue has been prepared with the utmost care. All technical data and information was checked before going to press.

Due to the continuous improvement and development of the ALFRA programme, we reserve the right to modify products from this catalogue or if necessary, also remove them from our product range. For this reason, technical data and products contained in this catalogue may differ - without notice.

Full or partial use and reproduction of this catalogue (drawings, pictures, texts, logos) are prohibited without written permission.

Photo credits:
Alfra GmbH, www.fotolia.com, www.123rf.com,
www.gettyimages.com

YOUR NOTES

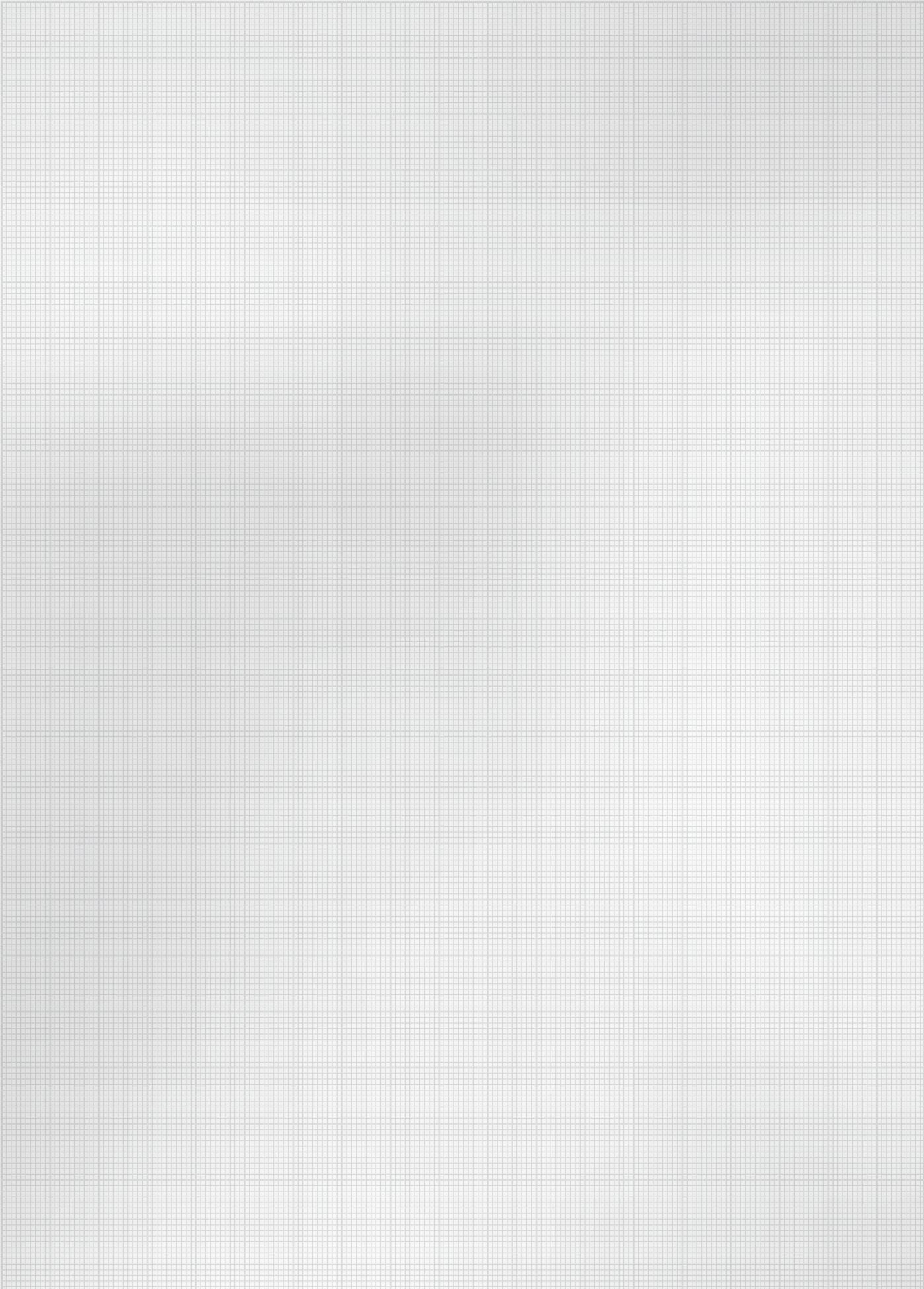

YOUR NOTES

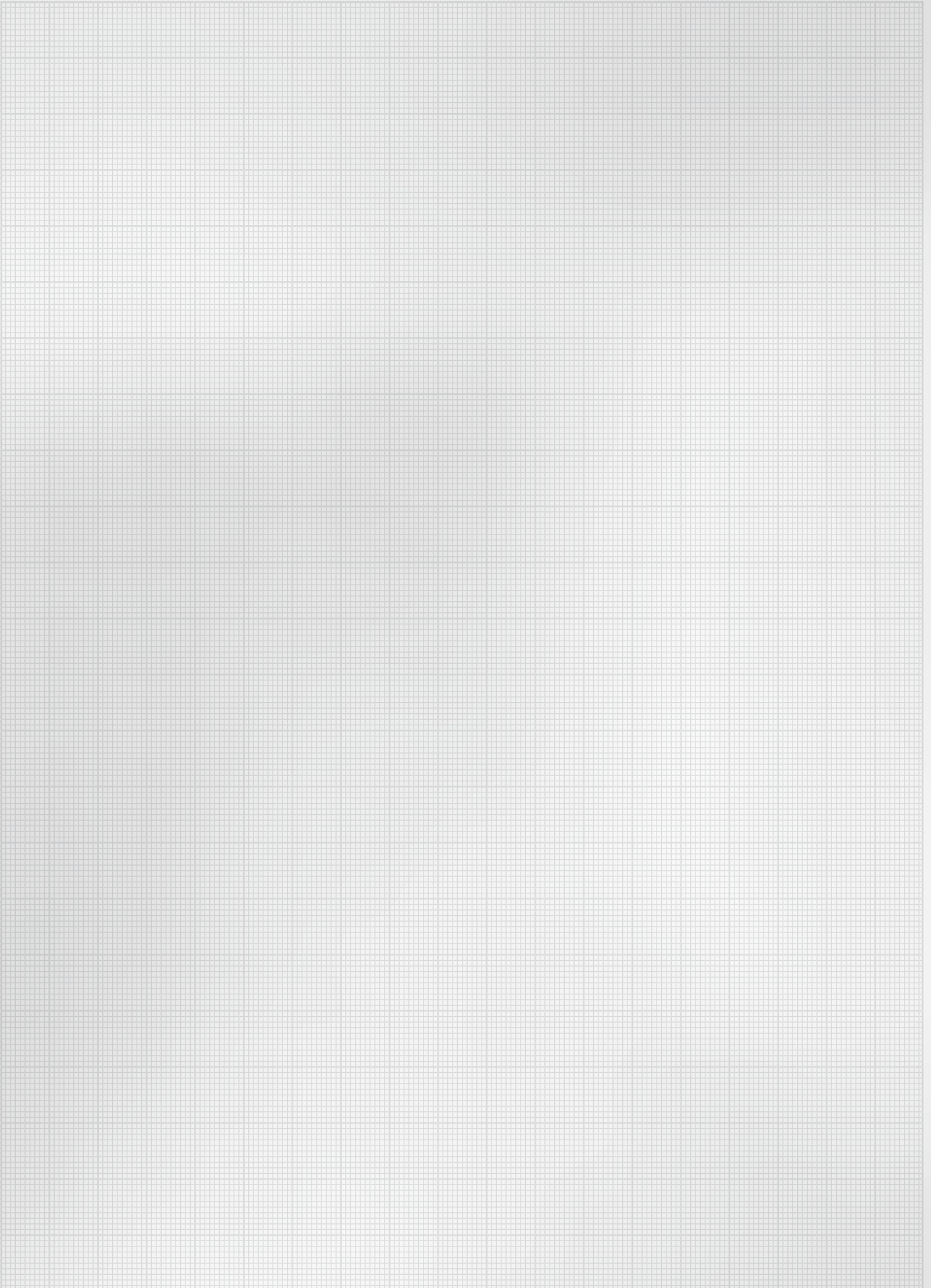



**APPLICATION SOLUTIONS
STEEL AND METAL CONSTRUCTION**



**APPLICATION SOLUTIONS
MAGNETICS AND LIFTING TECHNOLOGY**

