

GENERAL CATALOGUE

Electrical Enclosures, Cabinets & Data Racks

2023



IT'S TIME FOR FREEDOM

WIRELESS ELECTRIC VEHICLE
CHARGING

**Wireless Charging of Electric Taxis
(WiCET) Project, UK.**

Lumen Freedom delivered the world's first public installation of a Wireless Electric Vehicle Charging (WEVC) system using IP Enclosures custom electrical enclosures.

Table of Contents

Wall Mounted Electrical Enclosures	
S1 & S2 Steel Powder Coated	2-7
SS1 Stainless Steel	8-9
SS2 Stainless Steel	10-11
SS1 & SS2 Dimension Table	12-13
GRP Electrical Enclosures	14-17
Distribution Board Kits	18-19
Accessories (Wall Mounted Electrical Enclosures)	
Inner Doors	20-21
Distribution Board Kits	22-23
Rain Hoods	24-25
Shelf Kits	26-27
Mounting Brackets & Stands	28-29
Earth Kits, 19" Rails, Plan Pockets & DIN Rail	30-31
Floor Standing Electrical Cabinets	
MF1S Steel Powder Coated	32-33
MF1SS Stainless Steel	34-35
MF1S & MF1SS Dimension Table	36-37
Accessories (Floor Standing Electrical Enclosures)	
Inner Doors	38-39
Shelf Kits	40-41
Cover Plates & Contactor Brackets	42-43
Mounting Plates, DIN Rails & Brackets	44-45
Wall Mounted IP66 19" Data Racks	
SDW Steel Powder Coated	46-47
ADW Marine Grade Aluminium	48-49
SSDW Stainless Steel	50-51
Floor Mounted IP66 19" Data Racks	
SD Steel Powder Coated	52-53
SSD Stainless Steel	54-55
SD-HD Steel Powder Coated Heavy Duty	56-57
Accessories (19" Data Racks)	58
Data Rack Shelves & Brackets	59
DIN Terminal Rails & Distribution Boards	60
Rack Mounted DIN Rails, Cable Organisers & Miscellaneous Accessories	61
Pole Mounted Infrastructure Field Cabinets	
FC Steel Powder Coated	62-63
FCA Marine Grade Aluminium	64-65
Floor Mounted Infrastructure Field Cabinets	
FC Steel Powder Coated	66-67
FCA Marine Grade Aluminium	68-69
Double Bay Floor Mounted Infrastructure Field Cabinets	
FC Steel Powder Coated	70-71
FCA Marine Grade Aluminium	72-73
Outdoor Field Cabinets	
FC Steel Powder Coated	74-75
FC Steel Powder Coated: Double Bay	76-77
Air-Conditioned Infrastructure Field Cabinets	
FC Steel Powder Coated	78-79
FCA Marine Grade Aluminium	80-81
Accessories (Infrastructure Field Cabinets)	
Shelf Kits & General Accessories	82
Pedestal Bases & Pole-Mount Brackets	83
IP69K Hygienic Electrical Enclosures	
H IP69K Hygienic Electrical Enclosures	84-85
HPB IP69K Pushbutton Enclosures	86-87
HTB IP69K Terminal Boxes	88-89
IP66 Pushbutton Enclosures	
SSP IP66 Stainless Steel	90-91
IP66 Terminal Boxes	
SST IP66 Stainless Steel	92-93
HMI Enclosures	
HMI Steel Powder Coated	94-95
SSHMI Stainless Steel	96-97
Accessories-Support Arm Systems	98-99
Thermal Control	
Air Conditioners	100-103
Ventilation Fans & Filters	104-109
Vent Hoods & Shields	110-111
Heaters	112-113
Controllers	114
LED Surface-mounted Luminaires	115
Locking Solutions	116-117
Custom Electrical Enclosures	118-119
Technical Reference (Colour Chart, IP Ratings)	120-121

Mounted Electrical Enclosures

S1

Steel | Powder Coated

SINGLE DOOR | IP66



The IP Enclosures S1 range of powder coated galvanised steel single door enclosures are designed to house a variety of electrical switch and control equipment. They are suitable for internal and external electrical installations for industrial, infrastructure, commercial and communications applications. All IP Enclosures are built to precision to ensure consistent high quality standards.

Features & Specifications

IP Enclosures S1 range of steel electrical enclosures are suitable for general industrial applications.

Protection: IP66 IK10, NEMA 4
(Independent accredited test laboratory)

Standard: IEC62208, IEC/EN/AS60529, RoHS
(IEC/EN/AS61439 Compliant, Optional UL508A) 

Material:

- Body: 1.2mm galvanised steel sheet (up to 700x500x250)
1.5mm galvanised steel sheet (800x600x200 and above)
- Gland Plate: 1.5mm galvanised steel sheet
- Door: 1.5mm galvanised steel sheet
- Device Mounting Plate: 1.5mm galvanised steel sheet
- Seal: Polyurethane. UL listed.

Body: The robust monoblock body is fabricated using galvanised steel sheet (1.2mm-1.5mm). Flat face sealing surfaces are provided to increase seal life. Pre-fitted blind nutserts are incorporated to accommodate mounts and accessory fasteners to eliminate drilling and retain IP rating. Integral device plate mounts and M6 earth studs are provided. A galvanised steel gland plate is incorporated into the bottom face. Cutting, pressing and full continuous seam welding using precision automated manufacturing equipment ensures accuracy and consistent high quality.

Single Door: The robust surface mounted door is fabricated using 1.5mm galvanised steel sheet and incorporates concealed removable hinges with captive pins. The door is designed for a 110° opening. Each door contains cable management rails, an M6 earth stud and a high quality machine-applied foamed in place (FIP) Polyurethane seal. Two internal cable management rails can be removed to provide additional space for equipment, duct and door mounted control components.

Seal: A high quality machine-applied full perimeter UL listed Polyurethane seal foamed in place (FIP) provides excellent sealing over a long life. Temperature resistance -40°C to 80°C (160°C short term loading).

Lock: Chrome 5mm double bit insert quarter turn lock with key. A full range of locking options are available upon request.

Device Mounting Plate: The device mounting plate is fabricated using 1.5mm galvanised steel sheet, pressed to provide additional strength and supplied pre-fitted into the enclosure as standard.

Gland Plate: Gland plates incorporate a seal and are provided with fasteners. The size and quantity vary according to enclosure size. The gland plates are incorporated into the bottom face of the enclosure body, located towards the rear adjacent to the device plate for ease of cable management.

Surface Treatment: UL approved epoxy polyester powder coated with a textured finish 80-120 micron average thickness. Standard colour: RAL7035 (Other colours available upon request).



Mounted Electrical Enclosures

S2

Steel | Powder Coated

DOUBLE DOOR | IP55



The IP Enclosures S2 range of powder coated galvanised steel double door enclosures are designed to house a variety of electrical switch and control equipment. They are suitable for internal and external electrical installations for industrial, infrastructure, commercial and communications applications. All IP Enclosures are built to precision to ensure consistent high quality standards.

Features & Specifications

IP Enclosures S2 range of steel electrical enclosures are suitable for general industrial applications.

Protection: IP55 IK10, NEMA 3
(Independent accredited test laboratory)

Standard: IEC62208, IEC/EN/AS60529, RoHS
(IEC/EN/AS61439 Compliant, Optional UL508A) **CE UK CA**

Material:

- Body: 1.5mm galvanised steel sheet
- Gland Plate: 1.5mm galvanised steel sheet
- Door: 1.5mm galvanised steel sheet
- Device Mounting Plate: 1.5mm galvanised steel sheet
- Seal: Polyurethane. UL listed.

Body: The robust monoblock body is fabricated using 1.5mm galvanised steel sheet. Flat face sealing surfaces are provided to increase seal life. Pre-fitted blind nuts are incorporated to accommodate mounts and accessory fasteners to eliminate drilling and retain IP rating. Integral device plate mounts and M6 earth studs are provided. Gland plates are incorporated into the bottom face. Cutting, pressing and full continuous seam welding using precision automated manufacturing equipment ensures accuracy and consistent high quality.

Double Doors: The robust surface mounted doors are fabricated using 1.5mm galvanised steel sheet and incorporates concealed removable hinges with captive pins. The doors are designed to eliminate the central mullion to improve accessibility into the enclosure. The doors are designed for a 110° opening. Each door contains integral cable management rails, an M6 earth stud and a high quality machine-applied foamed in place (FIP) Polyurethane seal. Internal cable management rails can be removed to provide additional space for equipment, duct and door mounted control components.

Seal: A high quality machine-applied full perimeter UL listed Polyurethane seal foamed in place (FIP) provides excellent sealing over a long life. Temperature resistance -40°C to 80°C (160°C short term loading).

Lock: 3 point locking system with key-lock swing handle. A full range of locking solutions are available upon request.

Device Mounting Plate: The device mounting plate is fabricated using 1.5mm galvanised steel sheet, pressed to provide additional strength and supplied pre-fitted into enclosure as standard.

Gland Plates: Gland plates incorporate seals and are provided with fasteners. The size and quantity vary according to enclosure size. The gland plates are incorporated into the bottom face of the enclosure body, located towards the rear adjacent to the device plate for ease of cable management.

Surface Treatment: UL approved epoxy polyester powder coated with a textured finish 80-120 micron average thickness. Standard colour: RAL7035 (Other colours available upon request).



SINGLE DOOR | IP66



Part Number	Enclosure Size	Device Plate	Locks	Accessories			Part Number Suffix		
Standard	H x W x D (mm)	H x W (mm)	Qty	Inner Door	Rain Hood	Transparent Door	Optional Colours		
IP-302015	300 x 200 x 150	250 x 130	1	IP-PSID3020	IP-PSRH2015	-	-BLK	-OR	-RED
IP-302515	300 x 250 x 150	250 x 180	1	-	IP-PSRH2515	-	-BLK	-OR	-RED
IP-303015	300 x 300 x 150	250 x 230	1	IP-PSID3030	IP-PSRH3015	-	-BLK	-OR	-RED
IP-303020	300 x 300 x 200	250 x 230	1	IP-PSID3030	IP-PSRH3020	-	-BLK	-OR	-RED
IP-403015	400 x 300 x 150	350 x 230	1	IP-PSID4030	IP-PSRH3015	IP-4030WINDOOR	-BLK	-OR	-RED
IP-403020	400 x 300 x 200	350 x 230	1	IP-PSID4030	IP-PSRH3020	IP-4030WINDOOR	-BLK	-OR	-RED
IP-404020	400 x 400 x 200	350 x 330	1	IP-PSID4040	IP-PSRH4020	IP-4040WINDOOR	-BLK	-OR	-RED
IP-404030	400 x 400 x 300	350 x 330	1	IP-PSID4040	-	IP-4040WINDOOR	-BLK	-OR	-RED
IP-503015	500 x 300 x 150	450 x 230	1	IP-PSID5030	IP-PSRH3015	IP-5030WINDOOR	-BLK	-OR	-RED
IP-503020	500 x 300 x 200	450 x 230	1	IP-PSID5030	IP-PSRH3020	IP-5030WINDOOR	-BLK	-OR	-RED
IP-504020	500 x 400 x 200	450 x 330	1	IP-PSID5040	IP-PSRH4020	IP-5040WINDOOR	-BLK	-OR	-RED
IP-504025	500 x 400 x 250	450 x 330	1	IP-PSID5040	IP-PSRH4025	IP-5040WINDOOR	-BLK	-OR	-RED
IP-505020	500 x 500 x 200	450 x 430	1	IP-PSID5050	IP-PSRH5020	IP-5050WINDOOR	-BLK	-OR	-RED
IP-505025	500 x 500 x 250	450 x 430	1	IP-PSID5050	IP-PSRH5025	IP-5050WINDOOR	-BLK	-OR	-RED
IP-505030	500 x 500 x 300	450 x 430	1	IP-PSID5050	IP-PSRH5030	IP-5050WINDOOR	-BLK	-OR	-RED
IP-604020	600 x 400 x 200	550 x 330	2	IP-PSID6040	IP-PSRH4020	IP-6040WINDOOR	-BLK	-OR	-RED
IP-604025	600 x 400 x 250	550 x 330	2	IP-PSID6040	IP-PSRH4025	IP-6040WINDOOR	-BLK	-OR	-RED
IP-604030	600 x 400 x 300	550 x 330	2	IP-PSID6040	-	IP-6040WINDOOR	-BLK	-OR	-RED
IP-606020	600 x 600 x 200	550 x 530	2	IP-PSID6060	IP-PSRH6020	IP-6060WINDOOR	-BLK	-OR	-RED
IP-606030	600 x 600 x 300	550 x 530	2	IP-PSID6060	IP-PSRH6030	IP-6060WINDOOR	-BLK	-OR	-RED
IP-606040	600 x 600 x 400	550 x 530	2	IP-PSID6060	IP-PSRH6040	IP-6060WINDOOR	-BLK	-OR	-RED
IP-705020	700 x 500 x 200	650 x 430	2	IP-PSID7050	IP-PSRH5020	IP-7050WINDOOR	-BLK	-OR	-RED
IP-705025	700 x 500 x 250	650 x 430	2	IP-PSID7050	IP-PSRH5025	IP-7050WINDOOR	-BLK	-OR	-RED
IP-804030	800 x 400 x 300	750 x 330	2	IP-PSID8040	IP-PSRH4030	IP-8040WINDOOR	-BLK	-OR	-RED
IP-806020	800 x 600 x 200	750 x 530	2	IP-PSID8060	IP-PSRH6020	IP-8060WINDOOR	-BLK	-OR	-RED
IP-806025	800 x 600 x 250	750 x 530	2	IP-PSID8060	IP-PSRH6025	IP-8060WINDOOR	-BLK	-OR	-RED
IP-806030	800 x 600 x 300	750 x 530	2	IP-PSID8060	IP-PSRH6030	IP-8060WINDOOR	-BLK	-OR	-RED
IP-806040	800 x 600 x 400	750 x 530	2	IP-PSID8060	IP-PSRH6040	IP-8060WINDOOR	-BLK	-OR	-RED
IP-808020	800 x 800 x 200	750 x 730	2	IP-PSID8080	IP-PSRH8020	IP-8080WINDOOR	-BLK	-OR	-RED
IP-808030	800 x 800 x 300	750 x 730	2	IP-PSID8080	IP-PSRH8030	IP-8080WINDOOR	-BLK	-OR	-RED
IP-808040	800 x 800 x 400	750 x 730	2	IP-PSID8080	IP-PSRH8040	IP-8080WINDOOR	-BLK	-OR	-RED
IP-1006025	1000 x 600 x 250	950 x 530	2	IP-PSID10060	IP-PSRH6025	IP-10060WINDOOR	-BLK	-OR	-RED
IP-1006030	1000 x 600 x 300	950 x 530	2	IP-PSID10060	IP-PSRH6030	IP-10060WINDOOR	-BLK	-OR	-RED
IP-1008030	1000 x 800 x 300	950 x 730	2	IP-PSID10080	IP-PSRH8030	IP-10080WINDOOR	-BLK	-OR	-RED
IP-1008040	1000 x 800 x 400	950 x 730	2	IP-PSID10080	IP-PSRH8040	IP-10080WINDOOR	-BLK	-OR	-RED
IP-1206030	1200 x 600 x 300	1150 x 530	2	IP-PSID12060	IP-PSRH6030	IP-12060WINDOOR	-BLK	-OR	-RED
IP-1208030	1200 x 800 x 300	1150 x 730	2	IP-PSID12080	IP-PSRH8030	IP-12080WINDOOR	-BLK	-OR	-RED
IP-1208040	1200 x 800 x 400	1150 x 730	2	IP-PSID12080	IP-PSRH8040	IP-12080WINDOOR	-BLK	-OR	-RED

SINGLE DOOR, LANDSCAPE ORIENTATION | IP66



Part Number	Enclosure Size	Device Plate	Locks	Accessories			Part Number Suffix		
Standard	H x W x D (mm)	H x W (mm)	Qty	Inner Door	Rain Hood	Transparent Door	Optional Colours		
IP-L304015	300 x 400 x 150	250 x 330	1	IP-PSID3040	IP-PSRH4015	-	-BLK	-OR	-RED
IP-L304020	300 x 400 x 200	250 x 330	1	IP-PSID3040	IP-PSRH4020	-	-BLK	-OR	-RED
IP-L406020	400 x 600 x 200	350 x 530	1	IP-PSID4060	IP-PSRH6020	IP-4060WINDOOR	-BLK	-OR	-RED
IP-L406030	400 x 600 x 300	350 x 530	1	IP-PSID4060	IP-PSRH6030	IP-4060WINDOOR	-BLK	-OR	-RED
IP-L608030	600 x 800 x 300	750 x 730	2	IP-PSID6080	IP-PSRH8030	IP-6080WINDOOR	-BLK	-OR	-RED

SINGLE DOOR, FLOOR STANDING WITH PEDESTAL | IP66



Part Number	Enclosure Size	Device Plate	Locks	Accessories			Part Number Suffix		
Standard	H x W x D (mm)	H x W (mm)	Qty	Inner Door	Ventilated Roof	Transparent Door	Optional Colours		
IP-1408040	1400 x 800 x 400	1350 x 730	2	IP-PSID14080	IP-VR8040	-	-BLK	-OR	-RED
IP-1608040	1600 x 800 x 400	1550 x 730	2	IP-PSID16080	IP-VR8040	-	-BLK	-OR	-RED
IP-1608060	1600 x 800 x 600	1550 x 730	2	IP-PSID16080	-	-	-BLK	-OR	-RED
IP-20010040	2000 x 1000 x 400	1950 x 930	2	IP-PSID200100	IP-VR10040	-	-BLK	-OR	-RED

* +100mm base plinth

DOUBLE DOOR | IP55



Part Number	Enclosure Size	Device Plate	Lock	Accessories			Part Number Suffix		
Standard	H x W x D (mm)	H x W (mm)	Type	Inner Door	Rain Hood	Transparent Door	Optional Colours		
IP-L4010030	400 x 1000 x 300	350 x 930	2	IP-PSID40100	IP-PSRH10030	-	-BLK	-OR	-RED
IP-L4010040	400 x 1000 x 400	350 x 930	2	IP-PSID40100	IP-PSRH10040	-	-BLK	-OR	-RED
IP-L6010030	600 x 1000 x 300	550 x 930	3-Point	IP-PSID60100	IP-PSRH10030	-	-BLK	-OR	-RED
IP-L6010040	600 x 1000 x 400	550 x 930	3-Point	IP-PSID60100	IP-PSRH10040	-	-BLK	-OR	-RED
IP-L4012030	400 x 1200 x 300	350 x 1130	2	-	IP-PSRH12030	-	-BLK	-OR	-RED
IP-L4012040	400 x 1200 x 400	350 x 1130	2	-	IP-PSRH12040	-	-BLK	-OR	-RED
IP-L6012030	600 x 1200 x 300	550 x 1130	3-Point	-	IP-PSRH12030	-	-BLK	-OR	-RED
IP-L6012040	600 x 1200 x 400	550 x 1130	3-Point	-	IP-PSRH12040	-	-BLK	-OR	-RED
IP-10010030	1000 x 1000 x 300	950 x 930	3-Point	IP-PSID100100	IP-PSRH10030	-	-BLK	-OR	-RED
IP-10010040	1000 x 1000 x 400	950 x 930	3-Point	IP-PSID100100	IP-PSRH10040	-	-BLK	-OR	-RED
IP-12010030	1200 x 1000 x 300	1150 x 930	3-Point	IP-PSID120100	IP-PSRH10030	-	-BLK	-OR	-RED
IP-12010040	1200 x 1000 x 400	1150 x 930	3-Point	IP-PSID120100	IP-PSRH10040	-	-BLK	-OR	-RED
IP-12012030	1200 x 1200 x 300	1150 x 1130	3-Point	IP-PSID120120	IP-PSRH12030	-	-BLK	-OR	-RED
IP-12012040	1200 x 1200 x 400	1150 x 1130	3-Point	IP-PSID120120	IP-PSRH12040	-	-BLK	-OR	-RED

Mounted Electrical Enclosures

SS1

Stainless Steel Grade 304/304L

SINGLE DOOR | IP66



The IP Enclosures SS1 range of stainless steel single door enclosures are designed to house a variety of electrical switch and control equipment in extreme environments. They are suitable for internal and external electrical installations for industrial, infrastructure, commercial, communications, defence, marine, food and beverage applications. All IP Enclosures are built to precision to ensure consistent high quality standards.

Features & Specifications

IP Enclosures SS1 range of stainless steel electrical enclosures are suitable for general industrial applications.

Protection: IP66 IK10, NEMA 4x
(Independent accredited test laboratory)

Standard: IEC62208, IEC/EN/AS60529, RoHS (IEC/EN/AS61439 Compliant, Optional UL508A) 

Material:

- Body: 1.5mm Grade 304/304L Stainless Steel
- Door: 1.5mm Grade 304/304L Stainless Steel
- Device Mounting Plate: 1.5mm Galvanised Steel Sheet
- Seal: Polyurethane. UL listed.

Surface Finish: 0.4 micron Ra surface brushed finish

Body: The robust monoblock body is fabricated using 1.5mm Grade 304/304L Stainless Steel (Grade 316 is also available). Flat face sealing surfaces are provided to increase seal life. Pre-fitted blind nutserts are incorporated to accommodate mounts and accessory fasteners to eliminate drilling and retain IP rating. Integral device plate mounts and M6 earth studs are provided. Cutting, pressing and full continuous seam welding using precision automated manufacturing equipment ensures accuracy and consistent high quality.

Single Door: The robust surface mounted door is fabricated using 1.5mm Grade 304/304L Stainless Steel and incorporates concealed removable hinges with captive pins (Grade 316 is also available). The door is designed for a 110° opening. Each door contains cable management rails, an M6 earth stud and a high quality machine-applied foamed in place (FIP) Polyurethane seal. Two internal cable management rails can be removed to provide additional space for equipment, duct and door mounted control components.

Seal: A high quality machine-applied full perimeter UL listed Polyurethane seal foamed in place (FIP) provides excellent sealing over a long life. Temperature resistance -40°C to 80°C (160°C short term loading).

Lock: Grade 316 Stainless Steel 8mm square drive quarter turn lock with key. A full range of locking solutions are available upon request.

Device Mounting Plate: The device mounting plate is fabricated using 1.5mm galvanised steel sheet, pressed to provide additional strength and supplied pre-fitted into the enclosure as standard.

Incorporates many advanced features as standard

- Fabricated using grade 304 stainless steel (grade 316 is also available)
- Incorporates flat sealing face to improve seal life
- Includes door cable rails
- Includes nutserts for mounting brackets and accessories to retain IP rating
- Includes mounting points for accessories including inner door escutcheons, rain hoods etc.



Mounted Electrical Enclosures

SS2

Stainless Steel Grade 304/304L

DOUBLE DOOR | IP55





The IP Enclosures SS2 range of stainless steel double door enclosures are designed to house a variety of electrical switch and control equipment in extreme environments. They are suitable for internal and external electrical installations for industrial, infrastructure, commercial, communications, defence, marine, food and beverage applications. All IP Enclosures are built to precision to ensure consistent high quality standards.

Features & Specifications

IP Enclosures SS2 range of grade stainless steel electrical enclosures are suitable for general industrial applications.

Protection: IP55 IK10, NEMA 3x
(Independent accredited test laboratory)

Standard: IEC62208, IEC/EN/AS60529, RoHS (IEC/EN/AS61439 Compliant, Optional UL508A)  

Material:

- Body: 1.5mm Grade 304/304L Stainless Steel
- Door: 1.5mm Grade 304/304L Stainless Steel
- Device Mounting Plate: 1.5mm Galvanised Steel Sheet
- Seal: Polyurethane. UL listed.

Surface Finish: 0.4 micron Ra surface brushed finish

Body: The robust monoblock body is fabricated using 1.5mm Grade 304/304L Stainless Steel (Grade 316 is also available). Flat face sealing surfaces are provided to increase seal life. Pre-fitted blind nutserts are incorporated to accommodate mounts and accessory fasteners to eliminate drilling and retain IP rating. Integral device plate mounts and M6 earth studs are provided. Cutting, pressing and full continuous seam welding using precision automated manufacturing equipment ensures accuracy and consistent high quality.

Double Doors: The robust surface mounted doors are fabricated using 1.5mm Grade 304/304L Stainless Steel and incorporates concealed removable hinges with captive pins (Grade 316 is also available). The doors are designed to eliminate the central mullion to improve accessibility into the enclosure. The doors are designed for a 110° opening. Each door contains cable management rails, an M6 earth stud and a high quality machine-applied foamed in place (FIP) Polyurethane seal. Internal cable management rails can be removed to provide additional space for equipment, duct and door mounted control components.

Seal: A high quality machine-applied full perimeter UL listed Polyurethane seal foamed in place (FIP) provides excellent sealing over a long life. Temperature resistance -40°C to 80°C (160°C short term loading).

Lock: 3 point locking system with key-lock swing handle. A full range of locking solutions are available upon request.

Device Mounting Plate: The device mounting plate is fabricated using 1.5mm galvanised steel sheet, pressed to provide additional strength and supplied pre-fitted into the enclosure as standard.



Incorporates many advanced features as standard

- Fabricated using grade 304 stainless steel (grade 316 is also available)
- Incorporates flat sealing face to improve seal life
- Includes door cable rails
- Includes nutserts for mounting brackets and accessories to retain IP rating
- Includes mounting points for accessories including inner door escutcheons, rain hoods etc.

SINGLE DOOR | IP66

Part Number	Optional	Enclosure Size	Device Plate	Locks	Accessories		
Grade 304	Grade 316	H x W x D (mm)	H x W (mm)	Qty	Inner Door	Rain Hood	Transparent Door
IP-304-302015	IP-SS302015	300 x 200 x 150	250 x 130	1	IP-SSID3020	IP-SSRH2015	-
IP-304-302515	IP-SS302515	300 x 250 x 150	250 x 180	1	-	IP-SSRH2515	-
IP-304-303015	IP-SS303015	300 x 300 x 150	250 x 230	1	IP-SSID3030	IP-SSRH3015	-
IP-304-303020	IP-SS303020	300 x 300 x 200	250 x 230	1	IP-SSID3030	IP-SSRH3020	-
IP-304-403015	IP-SS403015	400 x 300 x 150	350 x 230	1	IP-SSID4030	IP-SSRH3015	IP-SS4030WINDOOR
IP-304-403020	IP-SS403020	400 x 300 x 200	350 x 230	1	IP-SSID4030	IP-SSRH3020	IP-SS4030WINDOOR
IP-304-404020	IP-SS404020	400 x 400 x 200	350 x 330	1	IP-SSID4040	IP-SSRH4020	IP-SS4040WINDOOR
IP-304-404030	IP-SS404030	400 x 400 x 300	350 x 330	1	IP-SSID4040	IP-SSRH4030	IP-SS4040WINDOOR
IP-304-503015	IP-SS503015	500 x 300 x 150	450 x 230	1	IP-SSID5030	IP-SSRH3015	IP-SS5030WINDOOR
IP-304-503020	IP-SS503020	500 x 300 x 200	450 x 230	1	IP-SSID5030	IP-SSRH3020	IP-SS5030WINDOOR
IP-304-504020	IP-SS504020	500 x 400 x 200	450 x 330	1	IP-SSID5040	IP-SSRH4020	IP-SS5040WINDOOR
IP-304-504025	IP-SS504025	500 x 400 x 250	450 x 330	1	IP-SSID5040	IP-SSRH4025	IP-SS5040WINDOOR
IP-304-505020	IP-SS505020	500 x 500 x 200	450 x 430	1	IP-SSID5050	IP-SSRH5020	IP-SS5050WINDOOR
IP-304-505025	IP-SS505025	500 x 500 x 250	450 x 430	1	IP-SSID5050	IP-SSRH5025	IP-SS5050WINDOOR
IP-304-505030	IP-SS505030	500 x 500 x 300	450 x 430	1	IP-SSID5050	IP-SSRH5030	IP-SS5050WINDOOR
IP-304-604020	IP-SS604020	600 x 400 x 200	550 x 330	2	IP-SSID6040	IP-SSRH4020	IP-SS6040WINDOOR
IP-304-604025	IP-SS604025	600 x 400 x 250	550 x 330	2	IP-SSID6040	IP-SSRH4025	IP-SS6040WINDOOR
IP-304-604030	IP-SS604030	600 x 400 x 300	550 x 330	2	IP-SSID6040	IP-SSRH4030	IP-SS6040WINDOOR
IP-304-606020	IP-SS606020	600 x 600 x 200	550 x 530	2	IP-SSID6060	IP-SSRH6020	IP-SS6060WINDOOR
IP-304-606030	IP-SS606030	600 x 600 x 300	550 x 530	2	IP-SSID6060	IP-SSRH6030	IP-SS6060WINDOOR
IP-304-606040	IP-SS606040	600 x 600 x 400	550 x 530	2	IP-SSID6060	IP-SSRH6040	IP-SS6060WINDOOR
IP-304-705020	IP-SS705020	700 x 500 x 200	650 x 430	2	IP-SSID7050	IP-SSRH5020	IP-SS7050WINDOOR
IP-304-705025	IP-SS705025	700 x 500 x 250	650 x 430	2	IP-SSID7050	IP-SSRH5025	IP-SS7050WINDOOR
IP-304-804030	IP-SS804030	800 x 400 x 300	750 x 330	2	IP-SSID8040	IP-SSRH4030	IP-SS8040WINDOOR
IP-304-806020	IP-SS806020	800 x 600 x 200	750 x 530	2	IP-SSID8060	IP-SSRH6020	IP-SS8060WINDOOR
IP-304-806025	IP-SS806025	800 x 600 x 250	750 x 530	2	IP-SSID8060	IP-SSRH6025	IP-SS8060WINDOOR
IP-304-806030	IP-SS806030	800 x 600 x 300	750 x 530	2	IP-SSID8060	IP-SSRH6030	IP-SS8060WINDOOR
IP-304-808020	IP-SS808020	800 x 800 x 200	750 x 730	2	IP-SSID8080	IP-SSRH8020	IP-SS8080WINDOOR
IP-304-808030	IP-SS808030	800 x 800 x 300	750 x 730	2	IP-SSID8080	IP-SSRH8030	IP-SS8080WINDOOR
IP-304-808040	IP-SS808040	800 x 800 x 400	750 x 730	2	IP-SSID8080	IP-SSRH8040	IP-SS8080WINDOOR
IP-304-1006025	IP-SS1006025	1000 x 600 x 250	950 x 530	2	IP-SSID10060	IP-SSRH6025	IP-SS10060WINDOOR
IP-304-1006030	IP-SS1006030	1000 x 600 x 300	950 x 530	2	IP-SSID10060	IP-SSRH6030	IP-SS10060WINDOOR
IP-304-1008030	IP-SS1008030	1000 x 800 x 300	950 x 730	2	IP-SSID10080	IP-SSRH8030	IP-SS10080WINDOOR
IP-304-1008040	IP-SS1008040	1000 x 800 x 400	950 x 730	2	IP-SSID10080	IP-SSRH8040	IP-SS10080WINDOOR
IP-304-1206030	IP-SS1206030	1200 x 600 x 300	1150 x 530	2	IP-SSID12060	IP-SSRH6030	IP-SS12060WINDOOR
IP-304-1208030	IP-SS1208030	1200 x 800 x 300	1150 x 730	2	IP-SSID12080	IP-SSRH8030	IP-SS12080WINDOOR
IP-304-1208040	IP-SS1208040	1200 x 800 x 400	1150 x 730	2	IP-SSID12080	IP-SSRH8040	IP-SS12080WINDOOR

Stainless Steel 304/304L

SS1 SS2

SINGLE DOOR, LANDSCAPE ORIENTATION | IP66

Part Number	Optional	Enclosure Size	Device Plate	Locks	Accessories		
Grade 304	Grade 316	H x W x D (mm)	H x W (mm)	Qty	Inner Door	Rain Hood	Transparent Door
IP-304-L304015	IP-SSL304015	300 x 400 x 150	250 x 330	1	IP-SSID3040	IP-SSRH4015	-
IP-304-L304020	IP-SSL304020	300 x 400 x 200	250 x 330	1	IP-SSID3040	IP-SSRH4020	-
IP-304-L406020	IP-SSL406020	400 x 600 x 200	350 x 530	1	IP-SSID4060	IP-SSRH6020	IP-SS4060WINDOOR
IP-304-L406030	IP-SSL406030	400 x 600 x 300	350 x 530	1	IP-SSID4060	IP-SSRH6030	IP-SS4060WINDOOR
IP-304-L608030	IP-SSL608030	600 x 800 x 300	550 x 730	2	IP-SSID6080	IP-SSRH8030	IP-SS6080WINDOOR

SINGLE DOOR, FLOOR STANDING WITH PEDESTAL | IP66

Part Number	Optional	Enclosure Size	Device Plate	Locks	Accessories		
Grade 304	Grade 316	H x W x D (mm)	H x W (mm)	Qty	Inner Door	Rain Hood	Transparent Door
IP-304-1408040	IP-SS1408040	1400* x 800 x 400	1350 x 730	2	IP-SSID14080	-	-
IP-304-1608040	IP-SS1608040	1600* x 800 x 400	1550 x 730	2	IP-SSID16080	-	-
IP-304-1608060	IP-SS1608060	1600* x 800 x 600	1550 x 730	2	IP-SSID16080	-	-
IP-304-20010040	IP-SS20010040	2000* x 1000 x 400	1950 x 930	2	IP-SSID200100	-	-

* +100mm base plinth

DOUBLE DOOR | IP55

Part Number	Optional	Enclosure Size	Device Plate	Lock	Accessories		
Grade 304	Grade 316	H x W x D (mm)	H x W (mm)	Type	Inner Door	Rain Hood	Transparent Door
IP-304-L4010030	IP-SSL4010030	400 x 1000 x 300	350 x 930	2	IP-SSID40100	IP-SSRH10030	-
IP-304-L4010040	IP-SSL4010040	400 x 1000 x 400	350 x 930	2	IP-SSID40100	IP-SSRH10040	-
IP-304-L6010030	IP-SSL6010030	600 x 1000 x 300	550 x 930	3-Point	IP-SSID60100	IP-SSRH10030	-
IP-304-L6010040	IP-SSL6010040	600 x 1000 x 400	550 x 930	3-Point	IP-SSID60100	IP-SSRH10040	-
IP-304-L4012030	IP-SSL4012030	400 x 1200 x 300	350 x 1130	2	-	IP-SSRH12030	-
IP-304-L4012040	IP-SSL4012040	400 x 1200 x 400	350 x 1130	2	-	IP-SSRH12040	-
IP-304-L6012030	IP-SSL6012030	600 x 1200 x 300	550 x 1130	3-Point	-	IP-SSRH12030	-
IP-304-L6012040	IP-SSL6012040	600 x 1200 x 400	550 x 1130	3-Point	-	IP-SSRH12040	-
IP-304-10010030	IP-SS10010030	1000 x 1000 x 300	950 x 930	3-Point	IP-SSID100100	IP-SSRH10030	-
IP-304-10010040	IP-SS10010040	1000 x 1000 x 400	950 x 930	3-Point	IP-SSID100100	IP-SSRH10040	-
IP-304-12010030	IP-SS12010030	1200 x 1000 x 300	1150 x 930	3-Point	IP-SSID120100	IP-SSRH10030	-
IP-304-12010040	IP-SS12010040	1200 x 1000 x 400	1150 x 930	3-Point	IP-SSID120100	IP-SSRH10040	-
IP-304-12012030	IP-SS12012030	1200 x 1200 x 300	1150 x 1130	3-Point	IP-SSID120120	IP-SSRH12030	-
IP-304-12012040	IP-SS12012040	1200 x 1200 x 400	1150 x 1130	3-Point	IP-SSID120120	IP-SSRH12040	-

GRP Electrical Enclosures

Glass-Fibre Reinforced Polyester

P1

SINGLE DOOR | IP65, IP66



The P1 range of GRP electrical enclosures are corrosion resistant, providing protection against corrosion in coastal environments and installations prone to exposure to chemicals and solvents.

Features & Specifications

The P1 range of GRP electrical enclosures are designed to house electrical switch and control equipment in harsh environments that require high levels of corrosion resistance.

Protection: IP65 to IP66 (Refer to table)

Standard: IEC62208, IEC/EN/AS60529  

Basic Parameters:

- Temperature Operating Conditions: -50°C to 85°C
- Flammability Category: V0
- Protection Class: II
- Impact Resistance: IK10
- Halogen-Free Materials

Material:

- Body: Glass-Fibre Reinforced Polyester (GRP)
- Door: Glass-Fibre Reinforced Polyester (GRP)
- Device Mounting Plate: Polyester (Optional: Steel)
- Seal: Polyurethane

Body: The robust body is manufactured from Glass-Fibre Reinforced Polyester (GRP). Pre-fitted encapsulated nuts are incorporated to accommodate mounting to eliminate drilling and retain IP rating. Integral device plate mounts are also provided.

Door: The door is manufactured from Glass-Fibre Reinforced Polyester (GRP). It incorporates concealed removable hinges and is designed to be reversible (left or right hand opening). A transparent door with window is also available.

Seal: Polyurethane.

Lock: The IP65 model is fitted with two quarter turn locks. The IP66 model is fitted with up to 4-point locking.

Device Mounting Plate: A polyester device mounting plate is provided pre-fitted. (Optional steel device mounting plates are available).

Colour: RAL7035

Benefits of GRP

SMC (Sheet Molding Compound) is a composite of unsaturated polyester resin reinforced with glass fiber (12-50 mm long) as well as mineral filler and other additives. In addition to basic components such as polyester resin, fibre-glass and filler, SMC contains various additives in the form of thickeners, anti-adhesive agents and flame retardants.

- Very good mechanical properties
- Resistance to high temperature
- Fire-resistance (self-extinguishing plastic)
- High resistance to low temperatures
- Resistance to weather conditions (UV)
- High insulation
- Easy machining (for holes and cutouts)
- Very good anti-corrosion properties
- Lightweight construction



GRP ENCLOSURES | Screwed/Keyed | IP66

Part Number	Enclosure Size	Mounting Plate	Lock Type	Mount Type	Accessories
SKU	H x W x D (mm)	H x W (mm)	Keyed/Screwed	Pole Mount	Steel Mount Plate
IP-GRP303010	306H x 284W x 115D	270 x 230	Keyed	Standard	IP-GRPSMP3030
IP-GRP303010-B	306H x 284W x 115D	270 x 230	Keyed	Pole-Mount*	IP-GRPSMP3030
IP-GRP303010-S	306H x 284W x 115D	270 x 230	Screwed	Standard	IP-GRPSMP3030
IP-GRP303010-SB	306H x 284W x 115D	270 x 230	Screwed	Pole-Mount*	IP-GRPSMP3030

Items marked with an asterisk "*" are provided with pole mount attachment molded into rear of enclosure.

GRP ENCLOSURES | 2 x Quarter Turn Locks | IP65

Part Number	Enclosure Size	Mounting Plate	Accessories		
SKU	H x W x D (mm)	H x W (mm)	Steel Mount Plate	Inner Door	DB Kit
IP-GRP403020	410H x 300W x 200D	350 x 240	IP-GRPSMP4030	-	IP-GRPDB4030
IP-GRP404020	410H x 410W x 211D	350 x 340	IP-GRPSMP4040	-	IP-GRPDB4040
IP-GRP504020	505H x 411W x 211D	450 x 340	IP-GRPSMP5040	-	IP-GRPDB5040
IP-GRP604020	605H x 411W x 211D	550 x 340	IP-GRPSMP6040	-	IP-GRPDB6040
IP-GRP604025	618H x 438W x 251D	550 x 360	IP-GRPSDP6040	IP-GRPID6040	IP-GRPDB604025
IP-GRP806030	816H x 616W x 323D	740 x 530	IP-GRPSDP8060	IP-GRPID8060	IP-GRPDB806030
IP-GRP1008530	1004H x 850W x 323D	925 x 755	IP-GRPSDP10085	IP-GRPID10085	IP-GRPDB1008530

GRP ENCLOSURES | Swing Handle up to 4 Point Locking | IP66

Part Number	Enclosure Size	Mounting Plate	Accessories		
SKU	H x W x D (mm)	H x W (mm)	Steel Mount Plate	Inner Door	DB Kit
IP-GRP403020-H	410H x 300W x 200D	350 x 240	IP-GRPSMP4030	-	IP-GRPDB4030
IP-GRP404020-H	410H x 410W x 211D	350 x 340	IP-GRPSMP4040	-	IP-GRPDB4040
IP-GRP504020-H	505H x 411W x 211D	450 x 340	IP-GRPSMP5040	-	IP-GRPDB5040
IP-GRP604020-H	605H x 411W x 211D	550 x 340	IP-GRPSMP6040	-	IP-GRPDB6040
IP-GRP604025-H	618H x 438W x 251D	550 x 360	IP-GRPSDP6040	IP-GRPID6040	IP-GRPDB604025
IP-GRP806030-H	816H x 616W x 323D	740 x 530	IP-GRPSDP8060	IP-GRPID8060	IP-GRPDB806030
IP-GRP1008530-H	1004H x 850W x 323D	925 x 755	IP-GRPSDP10085	IP-GRPID10085	IP-GRPDB1008530

GRP ENCLOSURES with WINDOW | 2 x Quarter Turn Locks | IP65

Part Number	Enclosure Size	Mounting Plate	Accessories		
SKU	H x W x D (mm)	H x W (mm)	Steel Mount Plate	Inner Door	DB Kit
IP-GRP604025-T	618H x 438W x 251D	550 x 360	IP-GRPSDP6040	IP-GRPID6040	IP-GRPDB604025
IP-GRP806030-T	816H x 616W x 323D	740 x 530	IP-GRPSDP8060	IP-GRPID8060	IP-GRPDB806030

POLE MOUNT BRACKET for GRP ENCLOSURES

Type of Enclosure	Pole Mount Bracket
IP-GRP3030B/SB	IP-9126001*
IP-GRP604025	IP-GRPUN20K3
IP-GRP806030	IP-GRPUN30K3
IP-GRP1008530	IP-GRPUPN20K3

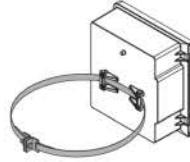

IP-GRP9126001

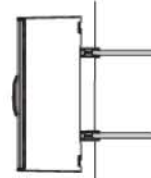

IP-GRPPUN20K3
IP-GRPPUN30K3
IP-GRPPUPN20K3
(Quantity 2 per set)



REAR COVER CAPS



Type of Enclosure	Rear Cover Caps
IP-GRP6040	IP-GRPZHTF46
IP-GRP8060	IP-GRPZHTF68
IP-GRP10085	IP-GRPZHTF68

PRESSURE VALVE & DRAIN



Part Number	Description
IP-GRPDA084	IP55 Pressure Compensation Valve
IP-GRPDA284	IP66 Pressure Compensation Valve
IP-GRPDD084	Condensate Drain

WALL MOUNT BRACKETS



Part Number	Description
IP-GRPUMOK3	Mounting Feet - Set of 4

(Quantity 4 per set)

DOOR STAY



Part Number	Description
IP-GRPBDH1	Door Stay for GRP Electrical Enclosure

BASES & PEDESTAL

Type of Enclosure	TYPE 1		TYPE 2		TYPE 3	
SKU	B1 (mm)	SKU	B1 (mm)	SKU	B1 (mm)	SKU
IP-GRP604025	911	IP-GRP604025-B1	1155	IP-GRP604025-B2	1536	IP-GRP604025-B3
IP-GRP806030	1109	IP-GRP806030-B1	1353	IP-GRP806030-B2	1734	IP-GRP806030-B3
IP-GRP1008530	1296	IP-GRP1008530-B1	1540	IP-GRP1008530-B2	1922	IP-GRP1008530-B3

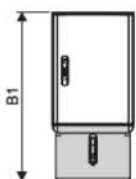

TYPE 1

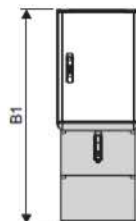

TYPE 2

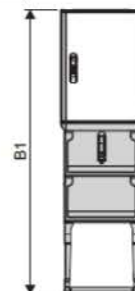

TYPE 3



Distribution Board Kits



Distribution Board Kits are designed to be easily fitted to GRP Electrical Enclosures.

Features & Specifications

IP Enclosures Distribution Kits are designed to be easily fitted to IP Enclosures GRP electrical enclosures without drilling.

Chassis Material: Galvanised steel sheet

DIN Rail Material: 7.5 x 35 High quality DIN Rail manufactured from galv steel for increased corrosion resistance. Standard 35mm wide symmetrical TS35 DIN Rail compatible with EN50022 and DIN46277-3.

Escutcheon Plates: Glass-Fibre Reinforced Polyester (GRP). Tool removable.

Colour: RAL7035

DB Kits for IP65 GRP Electrical Enclosures

Enclosure	Enclosure Size	Accessories	No. Pole
SKU	H x W x D (mm)	DB Kit	Rows x Qty = Qty Pole
IP-GRP404020	405H x 411W x 211D	IP-GRPDB4040	2 Rows x 16 = 32 Pole
IP-GRP504020	505H x 411W x 211D	IP-GRPDB5040	3 Rows x 16 = 48 Pole
IP-GRP604020	605H x 411W x 211D	IP-GRPDB6040	3 Rows x 16 = 48 Pole
IP-GRP604025	618H x 438W x 251D	IP-GRPDB604025	3 Rows x 16 = 48 Pole
IP-GRP806030	816H x 616W x 323D	IP-GRPDB806030	5 Rows x 26 = 130 Pole
IP-GRP1008530	1004H x 850W x 323D	IP-GRPDB1008530	6 Rows x 39 = 234 Pole

Enclosure	Enclosure Size	Accessories	No. Pole
SKU	H x W x D (mm)	DB Kit	Rows x Qty = Qty Pole
IP-GRP604025-T	618H x 438W x 251D	IP-GRPDB604025	3 Rows x 16 = 48 Pole
IP-GRP806030-T	816H x 616W x 323D	IP-GRPDB806030	5 Rows x 26 = 130 Pole

DB Kits for IP66 GRP Electrical Enclosures

Enclosure	Enclosure Size	Accessories	No. Pole
SKU	H x W x D (mm)	DB Kit	Rows x Qty = Qty Pole
IP-GRP404020-H	405H x 411W x 211D	IP-GRPDB4040	2 Rows x 16 = 32 Pole
IP-GRP504020-H	505H x 411W x 211D	IP-GRPDB5040	3 Rows x 16 = 48 Pole
IP-GRP604020-H	605H x 411W x 211D	IP-GRPDB6040	3 Rows x 16 = 48 Pole
IP-GRP604025-H	618H x 438W x 251D	IP-GRPDB604025	3 Rows x 16 = 48 Pole
IP-GRP806030-H	816H x 616W x 323D	IP-GRPDB806030	5 Rows x 26 = 130 Pole
IP-GRP1008530-H	1004H x 850W x 323D	IP-GRPDB1008530	6 Rows x 39 = 234 Pole



Accessories

ID

Inner Door Escutcheons | Wall Mounted



IP Enclosures inner door escutcheons are designed and manufactured to easily fit into any IP Enclosures wall mounted electrical enclosure without drilling. Inner doors are tool lockable.

Inner door escutcheons enable operators to access control equipment while maintaining separation of hazardous voltage equipment. Inner door kits can be fitted to all IP Enclosures wall mounted electrical enclosures without drilling.

STEEL RANGE

Material: 1.2-1.5mm galvanised steel sheet

Lock: Chrome 5mm double bit insert quarter turn lock.

Surface Treatment: UL approved epoxy polyester powder coated with a textured finish. 80-120 micron average thickness.

Standard colour: RAL7035. Other colour options are available. Refer to table below.

STEEL



Size	Accessories	Clearance Dimensions						Part Number Suffix		
H x W (mm)	Inner Door	Inner Door to Outer Door	Inner Door to Mounting Plate: Enclosure Depth					Optional Colours		
			150mm	200mm	250mm	300mm	400mm			
300 x 200	IP-PSID3020	68.3mm	67.8mm	-	-	-	-	-BLK	-OR	-RED
300 x 300	IP-PSID3030	68.3mm	67.8mm	117.8mm	-	-	-	-BLK	-OR	-RED
400 x 300	IP-PSID4030	68.3mm	-	117.8mm	-	217.8mm	-	-BLK	-OR	-RED
400 x 400	IP-PSID4040	68.3mm	-	117.8mm	-	217.8mm	-	-BLK	-OR	-RED
500 x 300	IP-PSID5030	68.3mm	67.8mm	117.8mm	-	-	-	-BLK	-OR	-RED
500 x 400	IP-PSID5040	68.3mm	-	117.8mm	167.8mm	-	-	-BLK	-OR	-RED
500 x 500	IP-PSID5050	68.3mm	-	117.8mm	167.8mm	217.8mm	-	-BLK	-OR	-RED
600 x 400	IP-PSID6040	68.3mm	-	117.8mm	167.8mm	217.8mm	-	-BLK	-OR	-RED
600 x 600	IP-PSID6060	68.3mm	-	117.8mm	-	217.8mm	317.8mm	-BLK	-OR	-RED
700 x 500	IP-PSID7050	68.3mm	-	117.8mm	167.8mm	-	-	-BLK	-OR	-RED
800 x 600	IP-PSID8060	68.3mm	-	117.8mm	167.8mm	217.8mm	-	-BLK	-OR	-RED
800 x 800	IP-PSID8080	68.3mm	-	117.8mm	-	217.8mm	317.8mm	-BLK	-OR	-RED
1000 x 600	IP-PSID10060	68.3mm	-	-	167.8mm	217.8mm	-	-BLK	-OR	-RED
1000 x 800	IP-PSID10080	68.3mm	-	117.8mm	-	217.8mm	317.8mm	-BLK	-OR	-RED
1000 x 1000	IP-PSID100100	68.3mm	-	-	-	217.8mm	317.8mm	-BLK	-OR	-RED
1200 x 600	IP-PSID12060	68.3mm	-	-	-	217.8mm	-	-BLK	-OR	-RED
1200 x 800	IP-PSID12080	68.3mm	-	-	-	217.8mm	317.8mm	-BLK	-OR	-RED
1200 x 1000	IP-PSID120100	68.3mm	-	-	-	217.8mm	317.8mm	-BLK	-OR	-RED
1200 x 1200	IP-PSID120120	68.3mm	-	-	-	217.8mm	317.8mm	-BLK	-OR	-RED

STAINLESS STEEL RANGE

Material: 1.2-1.5mm Grade 316/316L Stainless Steel

Lock: 316 Stainless Steel 8mm square drive quarter turn lock.

STAINLESS STEEL

Size	Accessories	Clearance Dimensions					
H x W (mm)	Inner Door	Inner Door to Outer Door	Inner Door to Mounting Plate: Enclosure Depth				
			150mm	200mm	250mm	300mm	400mm
300 x 200	IP-SSID3020	68mm	67.2mm	-	-	-	-
300 x 300	IP-SSID3030	68mm	67.2mm	117.2mm	-	-	-
400 x 300	IP-SSID4030	68mm	67.2mm	117.2mm	-	-	-
400 x 400	IP-SSID4040	68mm	-	117.2mm	-	-	-
500 x 400	IP-SSID5040	68mm	-	-	167.2mm	-	-
500 x 500	IP-SSID5050	68mm	-	117.2mm	167.2mm	-	-
600 x 400	IP-SSID6040	68mm	-	117.2mm	-	217.2mm	317.2mm
600 x 600	IP-SSID6060	68mm	-	117.2mm	-	217.2mm	317.2mm
700 x 500	IP-SSID7050	68mm	-	-	167.2mm	-	-
800 x 600	IP-SSID8060	68mm	-	-	167.2mm	217.2mm	-
800 x 800	IP-SSID8080	68mm	-	-	-	217.2mm	-
1000 x 600	IP-SSID10060	68mm	-	-	-	217.2mm	-
1000 x 800	IP-SSID10080	68mm	-	-	-	217.2mm	317.2mm
1000 x 1000	IP-SSID100100	68mm	-	-	-	217.2mm	317.2mm
1200 x 800	IP-SSID12080	68mm	-	-	-	217.2mm	-
1200 x 1000	IP-SSID120100	68mm	-	-	-	217.2mm	317.2mm
1200 x 1200	IP-SSID120120	68mm	-	-	-	217.2mm	317.2mm

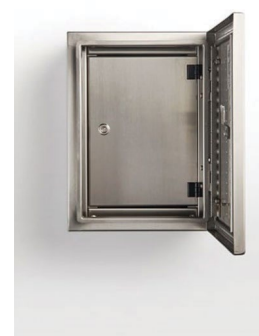

DIN Rail Kits | Wall Mounted



IP Enclosures DIN Rail Kits are designed to be easily fitted without drilling. The separate internal chassis frame can be fitted with components and wired prior to assembly into the enclosure. The removable escutcheon plates provide protection to the full perimeter of the enclosure.

The IP Enclosures DIN Rail Kits are designed to be easily fitted to IP Enclosures electrical enclosures without drilling. They can be fitted into steel and stainless steel enclosures.

DIN Rail Kits are suitable for steel and stainless steel enclosures. The separate internal chassis frame can be fitted with components and wired prior to assembly into the enclosure without drilling. Removable escutcheon plates provide protection to the perimeter of the enclosure.

Chassis Material: Galvanised steel sheet

Escutcheon Plates: UL approved epoxy polyester powder coated with a textured finish. 80-120 micron average thickness. The standard electrical enclosure colour is RAL7035. A full range of other colour options are available upon request.

Slotted Din Rail Material: Electrogalvanised Steel 7.5x35 RoHS Compliant. High quality DIN Rail manufactured from electrogalvanised steel for increased corrosion resistance. Standard 35mm wide symmetrical TS35 DIN Rail compatible with EN50022 and DIN46277-3.

- **Material:** Steel
- **Plating:** ALKALI ZINC Cr+3 TOP COAT (10-12 Microns)
- **Standards:** DIN5022, DIN5033, EN60715. RoHS Compliant.
- **Dimensions:** 7.5 mm deep x 35 mm wide.
- **Colour:** Silver
- **Type:** TS35 Slotted



Part Number	Size	Configuration
SKU	Pole, H x W (mm)	Qty Row x Qty
IP-DB12	12 Pole to suit 300H x 400W Enclosure	1 row of 12
IP-DB24	24 Pole to suit 400H x 400W Enclosure	2 rows of 12
IP-DB36	36 Pole to suit 600H x 400W Enclosure	3 rows of 12
IP-DB48	48 Pole to suit 400H x 600W Enclosure	2 rows of 24
IP-DB72	72 Pole to suit 600H x 600W Enclosure	3 rows of 24
IP-DB96	96 Pole to suit 800H x 600W Enclosure	4 rows of 24
IP-DB144	144 Pole to suit 1000H x 600W Enclosure	6 rows of 24
IP-DBFILLER	10 Pole Filler	-

Accessories

RH

Rain Hoods | Wall Mounted



IP Enclosures provide a range of standard rain hoods for steel and stainless steel electrical enclosures to prevent settling and building up of liquids, corrosive solids, minerals, dust, dirt and debris on top of the enclosure.

IP Enclosures provide a range of standard rain hoods for steel and stainless steel electrical enclosures. All IP Enclosures wall mounted electrical enclosures are manufactured with nutserts to accommodate rain hoods without drilling.

Rain hoods are used to prevent settling and building up of liquids, corrosive solids, minerals, dust, dirt and debris on top of an electrical enclosure. If corrosive liquids and solids settle and build up on top of an enclosure, the integrity of the coating and material may be compromised which may lead to corrosion and ingress of liquids and solids into the enclosure. Without maintenance, this may compromise internal electrical components and could increase risk of electric shock.

IP Enclosures rain hoods are easily fitted onto IP Enclosures electrical enclosures. All IP Enclosures electrical enclosures are manufactured with nutserts to accommodate optional rain hoods without drilling to ensure that the IP rating is maintained. Rain hoods are provided with fasteners.

STEEL RANGE

Material: 1.5mm galvanised steel sheet

Surface Treatment: UL approved epoxy polyester powder coated with a textured finish. 80-120 micron average thickness.

Standard colour: RAL7035.

STAINLESS STEEL RANGE

Material: 1.2-1.5mm Grade 316/316L Stainless Steel.

STEEL



Size W x D (mm)	Part Number Rain Hood	Part Number Suffix Optional Colours
200 x 150	IP-PSRH2015	-T33 -BLK -OR -RED
250 x 150	IP-PSRH2515	-T33 -BLK -OR -RED
300 x 150	IP-PSRH3015	-T33 -BLK -OR -RED
300 x 200	IP-PSRH3020	-T33 -BLK -OR -RED
400 x 150	IP-PSRH4015	-T33 -BLK -OR -RED
400 x 200	IP-PSRH4020	-T33 -BLK -OR -RED
400 x 250	IP-PSRH4025	-T33 -BLK -OR -RED
500 x 200	IP-PSRH5020	-T33 -BLK -OR -RED
500 x 250	IP-PSRH5025	-T33 -BLK -OR -RED
600 x 200	IP-PSRH6020	-T33 -BLK -OR -RED
600 x 250	IP-PSRH6025	-T33 -BLK -OR -RED
600 x 300	IP-PSRH6030	-T33 -BLK -OR -RED
800 x 200	IP-PSRH8020	-T33 -BLK -OR -RED
800 x 300	IP-PSRH8030	-T33 -BLK -OR -RED
00 x 400	IP-PSRH8040	-T33 -BLK -OR -RED
1000 x 300	IP-PSRH10030	-T33 -BLK -OR -RED
1000 x 400	IP-PSRH10040	-T33 -BLK -OR -RED
1200 x 300	IP-PSRH12030	-T33 -BLK -OR -RED
1200 x 400	IP-PSRH12040	-T33 -BLK -OR -RED

STAINLESS STEEL

Size W x D (mm)	Part Number Rain Hood
200 x 150	IP-SSRH2015
250 x 150	IP-SSRH2515
300 x 150	IP-SSRH3015
300 x 200	IP-SSRH3020
400 x 150	IP-SSRH4015
400 x 200	IP-SSRH4020
400 x 250	IP-SSRH4025
500 x 200	IP-SSRH5020
500 x 250	IP-SSRH5025
600 x 200	IP-SSRH6020
600 x 250	IP-SSRH6025
600 x 300	IP-SSRH6030
800 x 200	IP-SSRH8020
800 x 300	IP-SSRH8030
800 x 400	IP-SSRH8040
1000 x 300	IP-SSRH10030
1000 x 400	IP-SSRH10040
1200 x 300	IP-SSRH12030
1200 x 400	IP-SSRH12040



Accessories

Shelf Kits

SHL



IP Enclosures provide a range of adjustable component shelf kits for wall mounted electrical enclosures.

COMPONENT SHELF (Height Adjustable)

Shelf systems have many uses and can be used for component storage, separation and battery storage. Fixed shelves are pressed to provide strength and are provided with vertical rails and fasteners for ease of installation. Multiple shelves can be fitted into each cabinet and shelves can be fully adjusted to the correct positions.

Material: 1.2 to 1.5 mm galvanised steel sheet

Shelf Rating: 75kg



Part Number	Size	Shelf Rating
SKU	H x W x D (mm)	Kg
IP-SHL6030	600 H x 600 W x 300 D	75
IP-SHL6040	600H x 600 W x 400 D	75
IP-SHL8030	800H x 800 W x 300 D	75
IP-SHL8040	800H x 800 W x 400 D	75
IP-SHL10030	1000H x 1000 W x 300 D	75
IP-SHL10040	1000H x 1000 W x 400 D	75
IP-SHL12030	1200H x 1200 W x 300 D	75
IP-SHL12040	1200H x 1200 W x 400 D	75

Accessories

Mounting Brackets & Stands



IP Enclosures provide a range of electrical enclosure mounting solutions including pole mounting brackets.

WALL MOUNT BRACKETS (Set of 4)

Part Number	Description
IP-WMBKIT	Wall Mount Bracket Kit (4 Brackets including fasteners)
IP-SSWMBKIT	Stainless Steel Wall Mount Bracket Kit (4 Brackets including fasteners)



U-CHANNEL PROFILES

Steel

Part Number	Length (mm)
IP-PMP200	200
IP-PMP300	300
IP-PMP400	400
IP-PMP500	500
IP-PMP600	600
IP-PMP1200	1200

Stainless Steel

Part Number	Length (mm)
IP-SSPMP200	200
IP-SSPMP300	300
IP-SSPMP400	400
IP-SSPMP500	500
IP-SSPMP600	600
IP-SSPMP1200	1200



POLE MOUNT BRACKETS (To suit large variable diameter poles)

Part Number	Description
IP-PMB	Pole Mount Bracket
IP-SSPMB	Stainless Steel Pole Mount Bracket

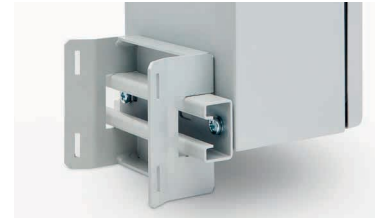

POLE MOUNT CLAMPS

Steel

Stainless Steel

Part Number	Part Number	Description
IP-PMSC43	IP-SSPMSC43	Ø43 Pole Mount Clamp to suit 32NB Pipe
IP-PMSC48	IP-SSPMSC48	Ø48 Pole Mount Clamp to suit 40NB Pipe
IP-PMSC60	IP-SSPMSC60	Ø60 Pole Mount Clamp to suit 50NB Pipe
IP-PMSC89	IP-SSPMSC89	Ø89 Pole Mount Clamp to suit 80NB Pipe
IP-PMSC115	IP-SSPMSC115	Ø115 Pole Mount Clamp to suit 100NB Pipe
IP-PMSC140	IP-SSPMSC140	Ø140 Pole Mount Clamp to suit 125NB Pipe
IP-PMSC165	IP-SSPMSC165	Ø165 Pole Mount Clamp to suit 150NB Pipe
IP-PMSC220	IP-SSPMSC220	Ø220 Pole Mount Clamp to suit 200NB Pipe

NOTE: Includes 2 x Channel Spring Nuts and Washers



PLINTHS (100mm High Base)

Steel



Stainless Steel

Part Number	W x D (mm)	Suffix	Part Number	W x D (mm)
IP-PLINTH6030	600W x 300D	-BLK -OR	IP-SSPLINTH6030	600W x 300D
IP-PLINTH6040	600W x 400D	-BLK -OR	IP-SSPLINTH6040	600W x 400D
IP-PLINTH8030	800W x 300D	-BLK -OR	IP-SSPLINTH8030	800W x 300D
IP-PLINTH8040	800W x 400D	-BLK -OR	IP-SSPLINTH8040	800W x 400D
IP-PLINTH10030	1000W x 300D	-BLK -OR	IP-SSPLINTH10030	1000W x 300D
IP-PLINTH10040	1000W x 400D	-BLK -OR	IP-SSPLINTH10040	1000W x 400D
IP-PLINTH12030	1200W x 300D	-BLK -OR	IP-SSPLINTH12030	1200W x 300D
IP-PLINTH12040	1200W x 400D	-BLK -OR	IP-SSPLINTH12040	1200W x 400D



Accessories

Earth Kits, 19" Rails, Plan Pockets, DIN Rail



IP Enclosures provide a wide range of accessories including wiring plan pockets. This includes self-adhesive polycarbonate, steel or stainless steel wiring plan pockets.

Accessories | Miscellaneous

Earthing Kits

Standard earthing kits are available. Earthing kits consist of:

- Earth wire with ring connection
- 2 x M6 Nuts (to suit electrical enclosure earth connection points)
- Earth sticker labels and instruction diagram

Part Number	Description
IP-EK01	Standard Earthing Kit



19" Data Rack Rail Kits

Convert a standard 600mm wide electrical enclosure into an IP66 19" Data Rack using our 19" Data Rack Kits. Simply fit and tighten nuts. **Material:** Grade 316 Stainless Steel

Part Number	Description
IP-SS19R600	19" 11RU to suit 600 H x 600 W Electrical Enclosure
IP-SS19R800	19" 16RU to suit 800 H x 600 W Electrical Enclosure



Wiring Plan Pockets

A4 wiring plan pockets are available in self-adhesive polycarbonate, steel or stainless steel.

Part Number	Description
IP-PCPPA4	A4 wiring plan pocket, Self-Adhesive Polycarbonate
IP-PSPPA4	A4 wiring plan pocket, Powdercoated Steel
IP-SSPPA4	A4 wiring plan pocket, 316 Stainless Steel



Slotted Din Rail 7.5 x 35 x 2m RoHS Compliant

High quality DIN Rail manufactured from electrogalvanised steel for increased corrosion resistance. RoHS-compliant (Restriction of Hazardous Substances) silver-coloured plating. 35mm wide symmetrical TS35 DIN Rail compatible with EN50022 and DIN46277-3.

Plating: ALKALI ZINC Cr+3 TOP COAT (10-12 Microns)

Standards: DIN5022, DIN5033, EN60715. RoHS Compliant.

Dimensions: 7.5 mm deep x 35 mm wide

Colour: Silver

Type: TS35 Slotted



Part Number	Description	Dimensions (L x W x D)	To Suit Enclosure (Width)
IP-DINRAIL7.5X35-130	DIN RAIL x 130mm (Pack of 10)	130mm x 35mm x 7.5mm	200mm
IP-DINRAIL7.5X35-230	DIN RAIL x 230mm (Pack of 10)	230mm x 35mm x 7.5mm	300mm
IP-DINRAIL7.5X35-330	DIN RAIL x 330mm (Pack of 10)	330mm x 35mm x 7.5mm	400mm
IP-DINRAIL7.5X35-430	DIN RAIL x 430mm (Pack of 10)	430mm x 35mm x 7.5mm	500mm
IP-DINRAIL7.5X35-530	DIN RAIL x 530mm (Pack of 10)	530mm x 35mm x 7.5mm	600mm

Floor Standing Electrical Cabinets

Steel | Powder Coated

MF1S

SINGLE DOOR | IP55





IP Enclosures MF1S range of powder coated galvanised steel floor standing electrical cabinets for low voltage switchgear and controlgear assemblies are suitable for general industrial applications. All IP Enclosures are built to precision to ensure high quality standards.

MF1S

IP Enclosures MF1S range of powder coated galvanised steel floor standing electrical cabinets for low voltage switchgear and controlgear assemblies are suitable for general industrial applications.

Protection: IP55

(Independent accredited test laboratory)

Standard: IEC62208, AS/EN/IEC60529, RoHS  
(IEC/EN/AS61439 Compliant)

Material:

- Main Frame: 2.0mm Galvanised Steel W Profile System
- Side, Rear & Roof Panels: 1.2mm Powder Coated Galvanised Steel Sheet
- Front Door: 2.0mm Powder Coated Galvanised Steel Sheet
- Mounting Plates: 1.5mm - 2.0mm Galvanised Steel Sheet
- Seal: EPDM

Main Frame: The robust modular main structure is fabricated using 2.0mm galvanised steel sheet W Profile system with 20mm hole pattern.

Door: The robust door is fabricated using 2.0mm powder coated galvanised steel sheet and incorporates four concealed hinges. The door is designed for a 135° opening. Each door contains earth studs and an A4 document pocket.

Side, Rear and Roof Panels: Removable panels are fabricated using 1.2mm powder coated galvanised steel sheet.

Base: 100mm high base

Door Seal: High quality EPDM replaceable door seal.

Lock: 4 point locking system with key-lock swing handle.

Device Mounting Plate: The device mounting plate is fabricated using 1.5-2.0mm mm galvanised steel sheet, pressed to provide additional strength.

Earthing: All panels are earthed to provide earthing continuity.

Surface Treatment: UL approved epoxy polyester powder coated with a textured finish. 80-120 micron average thickness.

- **Standard Colour:** RAL7035

- **Colour of Base:** RAL9005

(Other colours available upon request).

Accessories and Baying Kits: A full range of accessories are available including baying kits. Contact us for more information.

IP-MFSBAYKIT - Baying Kit to suit Freestanding Cabinets



Floor Standing Electrical Cabinets

Stainless Steel Grade 304/304L

MF1SS

SINGLE DOOR | IP55



IP Enclosures MF1SS range of grade 304 stainless steel floor standing electrical cabinets for low voltage switchgear and controlgear assemblies are suitable for general industrial applications. All IP Enclosures are built to precision to ensure high quality standards.

MF1SS

IP Enclosures MF1SS range of grade 304 stainless steel floor standing electrical cabinets for low voltage switchgear and control gear assemblies are suitable for general industrial applications.

Protection: IP55

(Independent accredited test laboratory)

Standard: IEC62208, AS/EN/IEC60529, RoHS  
(IEC61439 Compliant)

Material:

- Main Frame: 2.0mm Grade 304/304L Stainless Steel W Profile System
- Covers: 1.2mm Grade 304/304L Stainless Steel
- Front Door: 2.0mm Grade 304/304L Stainless Steel
- Mounting Plates: 1.5mm - 2.0mm Galvanised Steel Sheet
- Seal: EPDM

Surface Finish: 0.4 micron Ra surface brushed finish

Main Frame: The robust modular main structure is fabricated using 2.0mm grade 304 stainless steel W Profile system with 20mm hole pattern.

Door: The robust door is fabricated using 2.0mm grade 304 stainless steel and incorporates four concealed hinges. The door is designed for a 135° opening. Each door contains earth studs and an A4 document pocket.

Side, Rear and Roof Panels: Removable panels are fabricated using 1.2mm grade 304 stainless steel.

Base: 100mm high base

Door Seal: High quality EPDM replaceable door seal.

Lock: 4 point locking system with key-lock swing handle.

Device Mounting Plate: The device mounting plate is fabricated using 1.5-2.0mm mm galvanised steel sheet, pressed to provide additional strength.

Earthing: All panels are earthed to provide earthing continuity.

Accessories and Baying Kits: A full range of accessories are available including baying kits. Contact us for more information.

IP-MFSBAYKIT - Baying Kit to suit Freestanding Cabinets



Part Number	Cabinet Size			Supplied with KIT				Accessories	Option		
	KIT	H	W	D	Enclosure	Side Panel	Device Plate	Base	Inner Door	Colour	
IP-MFS1624040-KIT	1620	x	400	x	400	IP-MFS1624040	IP-MFSP16240	IP-MFSM16240	IP-MFSB4040	IP-MFSID16240	-OR
IP-MFS1624060-KIT	1620	x	400	x	600	IP-MFS1624060	IP-MFSP16260	IP-MFSM16240	IP-MFSB4060	IP-MFSID16240	-OR
IP-MFS1624080-KIT	1620	x	400	x	800	IP-MFS1624080	IP-MFSP16280	IP-MFSM16240	IP-MFSB4080	IP-MFSID16240	-OR
IP-MFS1626040-KIT	1620	x	600	x	400	IP-MFS1626040	IP-MFSP16240	IP-MFSM16240	IP-MFSB6040	IP-MFSID16260	-OR
IP-MFS1626060-KIT	1620	x	600	x	600	IP-MFS1626060	IP-MFSP16260	IP-MFSM16260	IP-MFSB6060	IP-MFSID16260	-OR
IP-MFS1626080-KIT	1620	x	600	x	800	IP-MFS1626080	IP-MFSP16280	IP-MFSM16260	IP-MFSB6080	IP-MFSID16260	-OR
IP-MFS1628040-KIT	1620	x	800	x	400	IP-MFS1628040	IP-MFSP16240	IP-MFSM16280	IP-MFSB8040	IP-MFSID16280	-OR
IP-MFS1628060-KIT	1620	x	800	x	600	IP-MFS1628060	IP-MFSP16260	IP-MFSM16280	IP-MFSB8060	IP-MFSID16280	-OR
IP-MFS1628080-KIT	1620	x	800	x	800	IP-MFS1628080	IP-MFSP16280	IP-MFSM16280	IP-MFSB8080	IP-MFSID16280	-OR
IP-MFS16210060-KIT	1620	x	1000	x	600	IP-MFS16210060	IP-MFSP16260	IP-MFSM162100	IP-MFSB10060	-	-OR
IP-MFS16210080-KIT	1620	x	1000	x	800	IP-MFS16210080	IP-MFSP16280	IP-MFSM162100	IP-MFSB10080	-	-OR
IP-MFS16212060-KIT	1620	x	1200*	x	600	IP-MFS16212060	IP-MFSP16260	IP-MFSM162120	IP-MFSB12060	-	-OR
IP-MFS16212080-KIT	1620	x	1200*	x	800	IP-MFS16212080	IP-MFSP16280	IP-MFSM162120	IP-MFSB12080	-	-OR
IP-MFS1864040-KIT	1860	x	400	x	400	IP-MFS1864040	IP-MFSP18640	IP-MFSM18640	IP-MFSB4040	IP-MFSID18640	-OR
IP-MFS1864060-KIT	1860	x	400	x	600	IP-MFS1864060	IP-MFSP18660	IP-MFSM18640	IP-MFSB4060	IP-MFSID18640	-OR
IP-MFS1864080-KIT	1860	x	400	x	800	IP-MFS1864080	IP-MFSP18680	IP-MFSM18640	IP-MFSB4080	IP-MFSID18640	-OR
IP-MFS1866040-KIT	1860	x	600	x	400	IP-MFS1866040	IP-MFSP18640	IP-MFSM18660	IP-MFSB6040	IP-MFSID18660	-OR
IP-MFS1866060-KIT	1860	x	600	x	600	IP-MFS1866060	IP-MFSP18660	IP-MFSM18660	IP-MFSB6060	IP-MFSID18660	-OR
IP-MFS1866080-KIT	1860	x	600	x	800	IP-MFS1866080	IP-MFSP18680	IP-MFSM18660	IP-MFSB6080	IP-MFSID18660	-OR
IP-MFS1868040-KIT	1860	x	800	x	400	IP-MFS1868040	IP-MFSP18640	IP-MFSM18680	IP-MFSB8040	IP-MFSID18680	-OR
IP-MFS1868060-KIT	1860	x	800	x	600	IP-MFS1868060	IP-MFSP18660	IP-MFSM18680	IP-MFSB8060	IP-MFSID18680	-OR
IP-MFS1868080-KIT	1860	x	800	x	800	IP-MFS1868080	IP-MFSP18680	IP-MFSM18680	IP-MFSB8080	IP-MFSID18680	-OR
IP-MFS18610060-KIT	1860	x	1000	x	600	IP-MFS18610060	IP-MFSP18660	IP-MFSM186100	IP-MFSB10060	IP-MFSID186100	-OR
IP-MFS18610080-KIT	1860	x	1000	x	800	IP-MFS18610080	IP-MFSP18680	IP-MFSM186100	IP-MFSB10080	IP-MFSID186100	-OR
IP-MFS18612060-KIT	1860	x	1200*	x	600	IP-MFS18612060	IP-MFSP18660	IP-MFSM186120	IP-MFSB12060	-	-OR
IP-MFS18612080-KIT	1860	x	1200*	x	800	IP-MFS18612080	IP-MFSP18680	IP-MFSM186120	IP-MFSB12080	-	-OR
IP-MFS2024040-KIT	2020	x	400	x	400	IP-MFS2024040	IP-MFSP20240	IP-MFSM20240	IP-MFSB4040	IP-MFSID20240	-OR
IP-MFS2024060-KIT	2020	x	400	x	600	IP-MFS2024060	IP-MFSP20260	IP-MFSM20240	IP-MFSB4060	IP-MFSID20240	-OR
IP-MFS2024080-KIT	2020	x	400	x	800	IP-MFS2024080	IP-MFSP20280	IP-MFSM20240	IP-MFSB4080	IP-MFSID20240	-OR
IP-MFS2026040-KIT	2020	x	600	x	400	IP-MFS2026040	IP-MFSP20240	IP-MFSM20260	IP-MFSB6040	IP-MFSID20260	-OR
IP-MFS2026060-KIT	2020	x	600	x	600	IP-MFS2026060	IP-MFSP20260	IP-MFSM20260	IP-MFSB6060	IP-MFSID20260	-OR
IP-MFS2026080-KIT	2020	x	600	x	800	IP-MFS2026080	IP-MFSP20280	IP-MFSM20260	IP-MFSB6080	IP-MFSID20260	-OR
IP-MFS2028040-KIT	2020	x	800	x	400	IP-MFS2028040	IP-MFSP20240	IP-MFSM20280	IP-MFSB8040	IP-MFSID20280	-OR
IP-MFS2028060-KIT	2020	x	800	x	600	IP-MFS2028060	IP-MFSP20260	IP-MFSM20280	IP-MFSB8060	IP-MFSID20280	-OR
IP-MFS2028080-KIT	2020	x	800	x	800	IP-MFS2028080	IP-MFSP20280	IP-MFSM20280	IP-MFSB8080	IP-MFSID20280	-OR
IP-MFS20210060-KIT	2020	x	1000	x	600	IP-MFS20210060	IP-MFSP20260	IP-MFSM202100	IP-MFSB10060	IP-MFSID202100	-OR
IP-MFS20210080-KIT	2020	x	1000	x	800	IP-MFS20210080	IP-MFSP20280	IP-MFSM202100	IP-MFSB10080	IP-MFSID202100	-OR
IP-MFS20212060-KIT	2020	x	1200*	x	600	IP-MFS20212060	IP-MFSP20260	IP-MFSM202120	IP-MFSB12060	-	-OR
IP-MFS20212080-KIT	2020	x	1200*	x	800	IP-MFS20212080	IP-MFSP20280	IP-MFSM202120	IP-MFSB12080	-	-OR

*1200 Wide Cabinets = Double Door

Part Number	Cabinet Size			Supplied with KIT				Accessories	
	KIT	H	W	D	Enclosure	Side Panel	Device Plate	Base	Inner Door
IP-304-MFSS1624040-KIT	1620	x 400	x 400		IP-304-MFSS1624040	IP-304-MFSSP16240	IP-MFSM16240	IP-304-MFSSB4040	IP-304-MFSSID16240
IP-304-MFSS1624060-KIT	1620	x 400	x 600		IP-304-MFSS1624060	IP-304-MFSSP16260	IP-MFSM16240	IP-304-MFSSB4060	IP-304-MFSSID16240
IP-304-MFSS1624080-KIT	1620	x 400	x 800		IP-304-MFSS1624080	IP-304-MFSSP16280	IP-MFSM16240	IP-304-MFSSB4080	IP-304-MFSSID16240
IP-304-MFSS1626040-KIT	1620	x 600	x 400		IP-304-MFSS1626040	IP-304-MFSSP16240	IP-MFSM16240	IP-304-MFSSB6040	IP-304-MFSSID16260
IP-304-MFSS1626060-KIT	1620	x 600	x 600		IP-304-MFSS1626060	IP-304-MFSSP16260	IP-MFSM16260	IP-304-MFSSB6060	IP-304-MFSSID16260
IP-304-MFSS1626080-KIT	1620	x 600	x 800		IP-304-MFSS1626080	IP-304-MFSSP16280	IP-MFSM16260	IP-304-MFSSB6080	IP-304-MFSSID16260
IP-304-MFSS1628040-KIT	1620	x 800	x 400		IP-304-MFSS1628040	IP-304-MFSSP16240	IP-MFSM16280	IP-304-MFSSB8040	IP-304-MFSSID16280
IP-304-MFSS1628060-KIT	1620	x 800	x 600		IP-304-MFSS1628060	IP-304-MFSSP16260	IP-MFSM16280	IP-304-MFSSB8060	IP-304-MFSSID16280
IP-304-MFSS1628080-KIT	1620	x 800	x 800		IP-304-MFSS1628080	IP-304-MFSSP16280	IP-MFSM16280	IP-304-MFSSB8080	IP-304-MFSSID16280
IP-304-MFSS16210060-KIT	1620	x 1000	x 600		IP-304-MFSS16210060	IP-304-MFSSP16260	IP-MFSM162100	IP-304-MFSSB10060	-
IP-304-MFSS16210080-KIT	1620	x 1000	x 800		IP-304-MFSS16210080	IP-304-MFSSP16280	IP-MFSM162100	IP-304-MFSSB10080	-
IP-304-MFSS16212060-KIT	1620	x 1200*	x 600		IP-304-MFSS16212060	IP-304-MFSSP16260	IP-MFSM162120	IP-304-MFSSB12060	-
IP-304-MFSS16212080-KIT	1620	x 1200*	x 800		IP-304-MFSS16212080	IP-304-MFSSP16280	IP-MFSM162120	IP-304-MFSSB12080	-
IP-304-MFSS1864040-KIT	1860	x 400	x 400		IP-304-MFSS1864040	IP-304-MFSSP18640	IP-MFSM18640	IP-304-MFSSB4040	IP-304-MFSSID18640
IP-304-MFSS1864060-KIT	1860	x 400	x 600		IP-304-MFSS1864060	IP-304-MFSSP18660	IP-MFSM18640	IP-304-MFSSB4060	IP-304-MFSSID18640
IP-304-MFSS1864080-KIT	1860	x 400	x 800		IP-304-MFSS1864080	IP-304-MFSSP18680	IP-MFSM18640	IP-304-MFSSB4080	IP-304-MFSSID18640
IP-304-MFSS1866040-KIT	1860	x 600	x 400		IP-304-MFSS1866040	IP-304-MFSSP18640	IP-MFSM18660	IP-304-MFSSB6040	IP-304-MFSSID18660
IP-304-MFSS1866060-KIT	1860	x 600	x 600		IP-304-MFSS1866060	IP-304-MFSSP18660	IP-MFSM18660	IP-304-MFSSB6060	IP-304-MFSSID18660
IP-304-MFSS1866080-KIT	1860	x 600	x 800		IP-304-MFSS1866080	IP-304-MFSSP18680	IP-MFSM18660	IP-304-MFSSB6080	IP-304-MFSSID18660
IP-304-MFSS1868040-KIT	1860	x 800	x 400		IP-304-MFSS1868040	IP-304-MFSSP18640	IP-MFSM18680	IP-304-MFSSB8040	IP-304-MFSSID18680
IP-304-MFSS1868060-KIT	1860	x 800	x 600		IP-304-MFSS1868060	IP-304-MFSSP18660	IP-MFSM18680	IP-304-MFSSB8060	IP-304-MFSSID18680
IP-304-MFSS1868080-KIT	1860	x 800	x 800		IP-304-MFSS1868080	IP-304-MFSSP18680	IP-MFSM18680	IP-304-MFSSB8080	IP-304-MFSSID18680
IP-304-MFSS18610060-KIT	1860	x 1000	x 600		IP-304-MFSS18610060	IP-304-MFSSP18660	IP-MFSM186100	IP-304-MFSSB10060	IP-304-MFSSID186100
IP-304-MFSS18610080-KIT	1860	x 1000	x 800		IP-304-MFSS18610080	IP-304-MFSSP18680	IP-MFSM186100	IP-304-MFSSB10080	IP-304-MFSSID186100
IP-304-MFSS18612060-KIT	1860	x 1200*	x 600		IP-304-MFSS18612060	IP-304-MFSSP18660	IP-MFSM186120	IP-304-MFSSB12060	-
IP-304-MFSS18612080-KIT	1860	x 1200*	x 800		IP-304-MFSS18612080	IP-304-MFSSP18680	IP-MFSM186120	IP-304-MFSSB12080	-
IP-304-MFSS2024040-KIT	2020	x 400	x 400		IP-304-MFSS2024040	IP-304-MFSSP20240	IP-MFSM20240	IP-304-MFSSB4040	IP-304-MFSSID20240
IP-304-MFSS2024060-KIT	2020	x 400	x 600		IP-304-MFSS2024060	IP-304-MFSSP20260	IP-MFSM20240	IP-304-MFSSB4060	IP-304-MFSSID20240
IP-304-MFSS2024080-KIT	2020	x 400	x 800		IP-304-MFSS2024080	IP-304-MFSSP20280	IP-MFSM20240	IP-304-MFSSB4080	IP-304-MFSSID20240
IP-304-MFSS2026040-KIT	2020	x 600	x 400		IP-304-MFSS2026040	IP-304-MFSSP20240	IP-MFSM20260	IP-304-MFSSB6040	IP-304-MFSSID20260
IP-304-MFSS2026060-KIT	2020	x 600	x 600		IP-304-MFSS2026060	IP-304-MFSSP20260	IP-MFSM20260	IP-304-MFSSB6060	IP-304-MFSSID20260
IP-304-MFSS2026080-KIT	2020	x 600	x 800		IP-304-MFSS2026080	IP-304-MFSSP20280	IP-MFSM20260	IP-304-MFSSB6080	IP-304-MFSSID20260
IP-304-MFSS2028040-KIT	2020	x 800	x 400		IP-304-MFSS2028040	IP-304-MFSSP20240	IP-MFSM20280	IP-304-MFSSB8040	IP-304-MFSSID20280
IP-304-MFSS2028060-KIT	2020	x 800	x 600		IP-304-MFSS2028060	IP-304-MFSSP20260	IP-MFSM20280	IP-304-MFSSB8060	IP-304-MFSSID20280
IP-304-MFSS2028080-KIT	2020	x 800	x 800		IP-304-MFSS2028080	IP-304-MFSSP20280	IP-MFSM20280	IP-304-MFSSB8080	IP-304-MFSSID20280
IP-304-MFSS20210060-KIT	2020	x 1000	x 600		IP-304-MFSS20210060	IP-304-MFSSP20260	IP-MFSM202100	IP-304-MFSSB10060	IP-304-MFSSID202100
IP-304-MFSS20210080-KIT	2020	x 1000	x 800		IP-304-MFSS20210080	IP-304-MFSSP20280	IP-MFSM202100	IP-304-MFSSB10080	IP-304-MFSSID202100
IP-304-MFSS20212060-KIT	2020	x 1200*	x 600		IP-304-MFSS20212060	IP-304-MFSSP20260	IP-MFSM202120	IP-304-MFSSB12060	-
IP-304-MFSS20212080-KIT	2020	x 1200*	x 800		IP-304-MFSS20212080	IP-304-MFSSP20280	IP-MFSM202120	IP-304-MFSSB12080	-

*1200 Wide Cabinets = Double Door

Inner Door Escutcheons | Floor Standing



Inner door escutcheons are designed to be easily fitted into new or existing IP Enclosures floor standing electrical cabinets.

Inner door escutcheons are an optional feature that can be easily fitted into IP Enclosures floor standing electrical cabinets. Inner door kits are provided with the inner door, two vertical rails and fasteners for easy assembly.

Inner doors enable operators to access control equipment inside an electrical cabinet while maintaining separation of hazardous voltage equipment within the hazardous voltage area behind the inner door. Hinged escutcheon plates accommodate control components such as circuit breaker handles, pushbuttons, indicator lights and HMI's.

STEEL RANGE

Material: 1.5mm Galvanised steel sheet

Lock: Chrome 5mm double bit insert quarter turn locks

Surface Treatment: UL approved epoxy polyester powder-coated with a textured finish 80-120 micron average thickness.

Standard colour: RAL7035.

STAINLESS STEEL RANGE

Material: 1.5mm Grade 316/316L stainless steel

Locks: 316ss 8mm square drive quarter turn locks.



STEEL



Size		Accessories	Option
H	W	Inner Door	Colour
1620	x 400	IP-MFSID16240	-OR
1620	x 600	IP-MFSID16260	-OR
1620	x 800	IP-MFSID16280	-OR
1860	x 400	IP-MFSID18640	-OR
1860	x 600	IP-MFSID18660	-OR
1860	x 800	IP-MFSID18680	-OR
1860	x 1000	IP-MFSID186100	-OR
2020	x 400	IP-MFSID20240	-OR
2020	x 600	IP-MFSID20260	-OR
2020	x 800	IP-MFSID20280	-OR
2020	x 1000	IP-MFSID202100	-OR

STAINLESS STEEL

Size		Accessories
H	W	Inner Door
1620	x 400	IP-MFSSID16240
1620	x 600	IP-MFSSID16260
1620	x 800	IP-MFSSID16280
1860	x 400	IP-MFSSID18640
1860	x 600	IP-MFSSID18660
1860	x 800	IP-MFSSID18680
1860	x 1000	IP-MFSSID186100
2020	x 400	IP-MFSSID20240
2020	x 600	IP-MFSSID20260
2020	x 800	IP-MFSSID20280
2020	x 1000	IP-MFSSID202100



Accessories

Shelf Kits | Floor Standing

SHL



IP Enclosures provide a range of fixed and sliding adjustable shelves for floor standing electrical cabinets.

IP Enclosures provide a range of fixed and sliding adjustable component shelf kits for floor standing electrical cabinets.

FIXED COMPONENT SHELF (Height Adjustable)

Fixed shelf systems have many uses and can be used for component storage, separation and battery storage. Fixed shelves are pressed to provide strength. They are provided with fasteners and can be fitted without drilling. Multiple shelves can be fitted into each cabinet and shelves can be fully adjusted to the correct positions.

Material: 1.2 to 1.5 mm galvanised steel sheet

Surface Treatment: UL approved epoxy polyester powder coated with a textured finish. 80-120 micron average thickness.

Standard colour: RAL7035. A full range of other colour options are available upon request.



Part Number	Description	Shelf Rating
SKU	Width x Depth (mm)	Kg
IP-SHL6060	600W x 600D Shelf System	50
IP-SHL6080	600W x 800D Shelf System	50
IP-SHL8060	800W x 600D Shelf System	50
IP-SHL8080	800W x 800D Shelf System	50
IP-SHL10060	1000W x 600D Shelf System	50
IP-SHL10080	1000W x 800D Shelf System	50

SLIDING SHELF / LAPTOP DRAWER

Sliding shelf (laptop drawer) kits are provided assembled complete with 4 screws for fast and easy installation into floor standing electrical cabinets without drilling.

Surface Treatment: UL approved epoxy polyester powder coated with a textured finish. 80-120 micron average thickness.

Standard colour: RAL7035. A full range of other colour options are available upon request.



Part Number	Description	Shelf Rating
SKU	Width (mm)	Kg
IP-MFS600LECTERN	600W Sliding Shelf	25
IP-MFS800LECTERN	800W Sliding Shelf	25

Accessories

Cover Plates & Brackets

CP



A range of front cover plates and brackets are available with and without MCB cutouts.

Front cover plates and cover plate brackets are available to suit each sizes of floor standing electrical cabinet.

FRONT COVER PLATES

Material: Galvanised steel sheet

Surface Treatment: UL approved epoxy polyester powder coated with a textured finish. 80-120 micron average thickness.

Standard colour: RAL7035.

Part Number	Height (mm) x Description	To Suit Width of Cabinet (mm)
IP-CP1640	160mm High Cover Plate	400mm Wide Cabinet
IP-CPMCB1640	160mm High with MCB Cutouts	400mm Wide Cabinet
IP-CP1660	160mm High Cover Plate	600mm Wide Cabinet
IP-CPMCB1660	160mm High with MCB Cutouts	600mm Wide Cabinet
IP-CP1680	160mm High Cover Plate	800mm Wide Cabinet
IP-CPMCB1680	160mm High with MCB Cutouts	800mm Wide Cabinet
IP-CP2440	240mm High Cover Plate	400mm Wide Cabinet
IP-CP2460	240mm High Cover Plate	600mm Wide Cabinet
IP-CP2480	240mm High Cover Plate	800mm Wide Cabinet
IP-CP3240	320mm High Cover Plate	400mm Wide Cabinet
IP-CP3260	320mm High Cover Plate	600mm Wide Cabinet
IP-CP3280	320mm High Cover Plate	800mm Wide Cabinet
IP-CP4040	400mm High Cover Plate	400mm Wide Cabinet
IP-CP4060	400mm High Cover Plate	600mm Wide Cabinet
IP-CP4080	400mm High Cover Plate	800mm Wide Cabinet
IP-CP4840	480mm High Cover Plate	400mm Wide Cabinet
IP-CP4860	480mm High Cover Plate	600mm Wide Cabinet
IP-CP4880	480mm High Cover Plate	800mm Wide Cabinet
IP-CP5640	560mm High Cover Plate	400mm Wide Cabinet
IP-CP5660	560mm High Cover Plate	600mm Wide Cabinet
IP-CP5680	560mm High Cover Plate	800mm Wide Cabinet
IP-CP6440	640mm High Cover Plate	400mm Wide Cabinet
IP-CP6460	640mm High Cover Plate	600mm Wide Cabinet
IP-CP6480	640mm High Cover Plate	800mm Wide Cabinet



Cover Plates Fitted



Cover Plates Removed

COVER BRACKETS

To fit Cover Plates, 1 x set of Cover Brackets are required. Select from below to suit the height of the electrical cabinet.

Part Number	Height (mm) x Description	To Suit Width of Cabinet (mm)
IP-CPP1620	1620mm High Cover Brackets	1620mm High Cabinet
IP-CPP1860	1860mm High Cover Brackets	1860mm High Cabinet
IP-CPP2020	2020mm High Cover Brackets	2020mm High Cabinet

Accessories

MP

Mounting Plates, DIN Rail & Brackets



A range of mounting plates, DIN Rail and brackets are available to suit each size of electrical cabinet.

Mounting Plates and DIN Rail are mounted using a wide range of bracket kits and depth slide bracket kits to provide infinite combinations of mounting positions.

DIN RAIL & BRACKETS

DIN Rail - SKU	Mounting Bracket - SKU	To Suit Width of Cabinet (mm)
IP-MCBR0040	IP-MCBP0040	400mm Wide Cabinet
IP-MCBR0060	IP-MCBP0060	600mm Wide Cabinet
IP-MCBR0080	IP-MCBP0080	800mm Wide Cabinet

MOUNTING PLATES

Part Number	Height (mm) x Description	To Suit Width of Cabinet (mm)
IP-MP160400	160mm High Mounting Plate	400mm Wide Cabinet
IP-MP160600	160mm High Mounting Plate	600mm Wide Cabinet
IP-MP160800	160mm High Mounting Plate	800mm Wide Cabinet
IP-MP240400	240mm High Mounting Plate	400mm Wide Cabinet
IP-MP240600	240mm High Mounting Plate	600mm Wide Cabinet
IP-MP240800	240mm High Mounting Plate	800mm Wide Cabinet
IP-MP320400	320mm High Mounting Plate	400mm Wide Cabinet
IP-MP320600	320mm High Mounting Plate	600mm Wide Cabinet
IP-MP320800	320mm High Mounting Plate	800mm Wide Cabinet
IP-MP400400	400mm High Mounting Plate	400mm Wide Cabinet
IP-MP400600	400mm High Mounting Plate	600mm Wide Cabinet
IP-MP400800	400mm High Mounting Plate	800mm Wide Cabinet
IP-MP560400	560mm High Mounting Plate	400mm Wide Cabinet
IP-MP560600	560mm High Mounting Plate	600mm Wide Cabinet
IP-MP560800	560mm High Mounting Plate	800mm Wide Cabinet
IP-MP640400	640mm High Mounting Plate	400mm Wide Cabinet
IP-MP640600	640mm High Mounting Plate	600mm Wide Cabinet
IP-MP640800	640mm High Mounting Plate	800mm Wide Cabinet
IP-MP720400	720mm High Mounting Plate	400mm Wide Cabinet
IP-MP720600	720mm High Mounting Plate	600mm Wide Cabinet
IP-MP720800	720mm High Mounting Plate	800mm Wide Cabinet



MOUNTING PLATE BRACKETS

To attach Mounting Plates to cabinet, select 1 x Bracket Kit below. (Note that several Mounting Plates can be attached to 1 x Bracket Kit providing the total height of Mounting Plates does not exceed height of Bracket Kit.)

Part Number	Height (mm) x Description
IP-MPB400-KIT	400mm High Mounting Plate Bracket Kit
IP-MPB600-KIT	600mm High Mounting Plate Bracket Kit
IP-MPB800-KIT	800mm High Mounting Plate Bracket Kit
IP-MPB1000-KIT	1000mm High Mounting Plate Bracket Kit

DEPTH SLIDE KIT

To attach Mounting Plate Bracket Kit, 1 x Depth Slide Kit is required (if existing Depth Slides are not suitably positioned). Select 1 x Depth Slide Kit to suit depth of cabinet.

Part Number	Depth (mm) to suit Depth of Cabinet
IP-DS400-KIT	400mm Depth Slide Kit
IP-DS600-KIT	600mm Depth Slide Kit
IP-DS800-KIT	800mm Depth Slide Kit

Wall Mounted IP66 19" Data Racks

SDW

Steel | Powder Coated

SINGLE DOOR | IP66 | (OPTIONAL HINGED REAR SWING FRAME)





The IP Enclosures SDW range of wall mounted IP66 19" data racks are designed for outdoor applications to house sensitive data network equipment in harsh environments. They are suitable for internal and external installations. All IP Enclosures are built to precision to ensure consistent high quality standards.

Features & Specifications

IP Enclosures SDW range of IP66 19" data racks are designed for outdoor applications to house sensitive data network equipment in harsh environments. They are suitable for internal and external installations. All IP Enclosures are built to precision to ensure consistent high quality standards.

Protection: IP66 IK10

Standard: AS/EN/IEC60529, EIA-310-D, RoHS  

Material:

- Enclosure Body: 1.5mm galvanised steel sheet
- Enclosure Door: 1.5mm galvanised steel sheet
- 19" Data Rack Rails: 1.5mm galvanised steel sheet
- Enclosure Seal: Polyurethane. UL listed.

Body & 19" Rails: The robust monoblock body is 1.5mm galvanised steel sheet. Flat face sealing surfaces increase seal life. Pre-fitted blind nuts are incorporated to accommodate wall mounting brackets to eliminate drilling to retain IP rating. The profiled roof design protrudes past the seal, flush with the front of the door face. A galvanised steel gland plate is also incorporated into the bottom face. 19" data rack rails are fitted. 600mm deep racks include front and rear rails.

Door: The surface mounted door is 1.5mm galvanised steel sheet. It incorporates concealed removable hinges with captive pins. Doors are also designed for a 110° opening. Each door incorporates a high quality machine-applied foamed in place (FIP) Polyurethane seal.

Seal: A high quality machine-applied full perimeter UL listed Polyurethane seal foamed in place (FIP) provides excellent sealing over a long life. Temperature resistance -40°C to 80°C (160°C short term loading).

Lock: Chrome 5mm double bit insert quarter turn lock with key. A full range of locking solutions are available upon request.

Gland Plate: Gland plates are incorporated into the bottom face of the enclosure for cable management. The size and quantity vary according to enclosure size.

Surface Treatment: UL approved epoxy polyester powder coated with a textured finish 80-120 micron average thickness.

Standard Colour: RAL7035 Light Grey (*Other colours available upon request*).

Accessories: A range of data rack accessories are available.



Part Number	Size	Accessories
Standard	U/RU x Depth (mm)	Transparent Door
IP-SDW4RU30	4U x 300 Deep 19" Data Rack	-
IP-SDW6RU30	6U x 300 Deep 19" Data Rack	IP-3060WINDOOR
IP-SDW6RU45	6U x 450 Deep 19" Data Rack	IP-3060WINDOOR
IP-SDW9RU45	9U x 450 Deep 19" Data Rack	-
IP-SDW12RU45	12U x 450 Deep 19" Data Rack	IP-6060WINDOOR
IP-SDW12RU60	12U x 600 Deep 19" Data Rack	IP-6060WINDOOR
IP-SDW15RU60	15U x 600 Deep 19" Data Rack	IP-6060WINDOOR

Mounted IP66 19" Data Racks

ADW

Marine Grade Aluminium | Powder Coated

SINGLE DOOR | IP66 | (OPTIONAL HINGED REAR SWING FRAME)



The IP Enclosures ADW range of aluminium wall mounted IP66 19" data racks are designed for outdoor applications to house sensitive data network equipment in harsh environments. They are suitable for internal and external installations. All IP Enclosures are built to precision to ensure consistent high quality standards.

Features & Specifications

IP Enclosures ADW range of aluminium IP66 19" data racks are designed for outdoor applications to house sensitive data network equipment in harsh environments. They are suitable for internal and external installations. All IP Enclosures are built to precision to ensure consistent high quality standards.

Protection: IP66 IK10

Standard: AS/EN/IEC60529, EIA-310-D, RoHS  

Material:

- Enclosure Body: 1.5mm Marine Grade Aluminium 5754-H111
- Enclosure Door: 1.5mm Marine Grade Aluminium 5754-H111
- Enclosure Seal: Polyurethane. UL listed.

Body: The robust monoblock body is fabricated from 1.5mm marine grade aluminium sheet. Flat face sealing surfaces increase seal life. Pre-fitted blind nuts are incorporated to accommodate wall mounting brackets to eliminate drilling to retain IP rating. The profiled roof design protrudes past the seal, flush with the front of the door face. 19" data rack rails are fitted. 600mm deep racks include front and rear rails.

Door: The surface mounted door is fabricated from 1.5mm aluminium sheet. It incorporates concealed removable hinges with captive pins. Doors are also designed for a 110° opening. Each door incorporates a high quality machine-applied foamed in place (FIP) Polyurethane seal.

Seal: A high quality machine-applied full perimeter UL listed Polyurethane seal foamed in place (FIP) provides excellent sealing over a long life. Temperature resistance -40°C to 80°C (160°C short term loading).

Lock: Chrome 5mm double bit insert quarter turn lock with key. A full range of locking solutions are available upon request.

Gland Plate: Gland plates are incorporated into the bottom face of the enclosure for cable management. The size and quantity vary according to enclosure size.

Surface Treatment: UL approved epoxy polyester powder coated with a textured finish 80-120 micron average thickness.

-Standard Colour: RAL7035 Light Grey (*Other colours available upon request*).

Accessories: A range of data rack accessories are available.



Part Number	Size	Accessories
Standard	U/RU x Depth (mm)	Transparent Door
IP-ADW4RU30	4U x 300 Deep 19" Data Rack	-
IP-ADW6RU30	6U x 300 Deep 19" Data Rack	IP-A3060WINDOOR
IP-ADW6RU45	6U x 450 Deep 19" Data Rack	IP-A3060WINDOOR
IP-ADW9RU45	9U x 450 Deep 19" Data Rack	-
IP-ADW12RU45	12U x 450 Deep 19" Data Rack	IP-A6060WINDOOR
IP-ADW12RU60	12U x 600 Deep 19" Data Rack	IP-A6060WINDOOR
IP-ADW15RU60	15U x 600 Deep 19" Data Rack	IP-A6060WINDOOR

Mounted IP66 19" Data Racks

Stainless Steel Grade 304/304L

SSDW

SINGLE DOOR | IP66





The IP Enclosures SSDW range of stainless steel wall mounted IP66 19" data racks are designed to house sensitive data network equipment in harsh environments. They are suitable for internal and external installations.

Features & Specifications

The IP Enclosures SSDW range of stainless steel wall mounted IP66 19" data racks are designed to house sensitive data network equipment in harsh environments. They are suitable for internal and external installations. All IP Enclosures are built to precision to ensure consistent high quality standards.

Protection: IP66 IK10

Standard: AS/EN/IEC60529, EIA-310-D, RoHS  

Material:

- Body: 1.5mm Grade 304/304L Stainless Steel
- Door: 1.5mm Grade 304/304L Stainless Steel
- 19" Data Rack Rails: 1.5mm galvanised steel sheet
- Seal: Polyurethane

Surface Finish: 0.4 micron Ra surface brushed finish

Body: The robust monoblock body is fabricated using 1.5mm Grade 304/304L Stainless Steel. Cutting, pressing and full continuous seam welding using precision automated manufacturing equipment to ensure accuracy and consistent high quality. Flat face sealing surfaces are provided to increase seal life. A stainless steel gland plate is also incorporated into the bottom face. Adjustable 19" data rack rails are provided fitted. 600mm deep racks include front and rear rails.

Door: The robust surface mounted door is fabricated using 1.5mm Grade 304/304L Stainless Steel and incorporates concealed removable hinges with captive pins. The door is designed for a 110° opening and contains integral cable management rail studs, M6 earth stud and a high quality machine-applied foamed in place (FIP Polyurethane seal. Two internal cable management rails can be removed to provide additional space for equipment, duct and door mounted control components.

Seal: A high quality machine-applied full perimeter UL listed Polyurethane seal foamed in place (FIP provides excellent sealing over a long life. Temperature resistance -40°C to 80°C (160°C short term loading).

Lock: Grade 316 Stainless Steel 8mm square drive quarter turn lock with key. A full range of locking solutions are available upon request.



Part Number	Optional	Size
Grade 304	Grade 316	U/RU x Depth (mm)
IP-304-DW4RU30	IP-SSDW4RU30	4U x 300 Deep 19" Data Rack
IP-304-DW6RU30	IP-SSDW6RU30	6U x 300 Deep 19" Data Rack
IP-304-DW6RU45	IP-SSDW6RU45	6U x 450 Deep 19" Data Rack
IP-304-DW9RU45	IP-SSDW9RU45	9U x 450 Deep 19" Data Rack
IP-304-DW12RU45	IP-SSDW12RU45	12U x 450 Deep 19" Data Rack
IP-304-DW12RU60	IP-SSDW12RU60	12U x 600 Deep 19" Data Rack

Floor Standing IP66 19" Data Racks

Steel | Powder Coated

SD

SINGLE DOOR | IP66





The IP Enclosures SD range of floor standing IP66 19" data racks are designed for outdoor applications to house sensitive data network equipment in harsh environments. They are suitable for internal and external installations. All IP Enclosures are built to precision to ensure consistent high quality standards.

Features & Specifications

IP Enclosures SD range of IP66 19" data racks are designed for outdoor applications to house sensitive data network equipment in harsh environments.

Protection: IP66 IK10

Standard: AS/EN/IEC60529, EIA-310-D, RoHS  

Material:

- Enclosure Body: 1.5mm galvanised steel sheet
- Enclosure Door: 1.5mm galvanised steel sheet
- 19" Data Rack Rails: 1.5mm galvanised steel sheet
- Enclosure Seal: Polyurethane

Body: The robust monoblock body is 1.5mm galvanised steel sheet. Flat face sealing surfaces increase seal life. A gland plate is also incorporated into the bottom face.

Door/s: The surface mounted door is 1.5mm galvanised steel sheet. It incorporates concealed removable hinges with captive pins. Doors are also designed for a 110° opening.

Door Seal: A high quality full perimeter seal provides excellent sealing over a long life. It is machine applied Polyurethane foamed in place (FIP).

Lock: 3 point locking system with key-lock swing handle. A full range of locking solutions are available upon request.

Gland Plate: Gland plates with seals are incorporated into the bottom face of the enclosure for cable management.

Surface Treatment: UL approved epoxy polyester powder coated with a textured finish. 80-120 micron average thickness. Standard Colour: RAL7035.



Part Number	Size	No. of U (RU)	Cabinet Size
SKU	19"	U/RU	U/RU H x W x D (mm)
IP-SD606040	19"	12U	12U 600 x 600 x 400
IP-SD806040	19"	16U	16U 650 x 600 x 400
IP-SD806060	19"	16U	16U 850 x 600 x 600
IP-SD806080	19"	16U	16U 850 x 600 x 800
IP-SD1206040	19"	24U	24U 850 x 600 x 400
IP-SD1206060	19"	24U	24U 1200 x 600 x 600
IP-SD1206080	19"	24U	24U 1200 x 600 x 800
IP-SD1606060	19"	32U	32U 1600 x 600 x 600
IP-SD1606080	19"	32U	32U 1550 x 600 x 800
IP-SD2006060	19"	42U	42U 1550 x 600 x 600
IP-SD2006080	19"	42U	42U 2000 x 600 x 800

Floor Standing IP66 19" Data Racks

Stainless Steel Grade 304/304L

SSD

SINGLE DOOR | IP66





The IP Enclosures SSD range of stainless steel floor standing IP66 19" data racks are designed to house sensitive data network equipment in harsh environments. They are suitable for internal and external installations. All IP Enclosures are built to precision to ensure consistent high quality standards.

Features & Specifications

IP Enclosures SSD range of IP66 19" stainless steel data racks are designed to house sensitive data network equipment in harsh environments. They are suitable for internal and external installations.

Protection: IP66 IK10

Standard: AS/EN/IEC60529, EIA-310-D, RoHS  

Material:

- Enclosure Body: 1.5mm Grade 304/304L Stainless Steel
- Enclosure Door: 1.5mm Grade 304/304L Stainless Steel
- 19" Data Rack Rails: 1.5mm galvanised steel sheet
- Enclosure Seal: Polyurethane

Surface Finish: 0.4 micron Ra surface brushed finish

Body: The robust monoblock body is fabricated using 1.5mm Grade 304/304L Stainless Steel. Cutting, pressing and full continuous seam welding using precision automated manufacturing equipment to ensure accuracy and consistent high quality. Flat face sealing surfaces are provided to increase seal life. A stainless steel gland plate with seal is also incorporated into the bottom face.

Door: The robust surface mounted door is fabricated using 1.5mm Grade 304/304L Stainless Steel and incorporates concealed removable hinges with captive pins. The door is designed for a 110° opening. Each door contains a high quality machine-applied foamed in place (FIP) Polyurethane seal.

Door Seal: A high quality machine-applied continuous foamed in place (FIP) Polyurethane seal provides excellent sealing over a long life.

Lock: 3 point locking system with key-lock swing handle. A full range of locking solutions are available upon request.

Gland Plate: Gland plates are incorporated into the bottom face of the enclosure for cable management. They are provided with gaskets and fasteners. The size and quantity vary according to enclosure size.

Part Number	Optional	Size	No. of U (RU)	Cabinet Size
Grade 304	Grade 316	19"	U/RU	U/RU H x W x D (mm)
IP-304-D606040	IP-SSD606040	19"	12U	12U 600 x 600 x 400
IP-304-D806040	IP-SSD806040	19"	16U	16U 650 x 600 x 400
IP-304-D806060	IP-SSD806060	19"	16U	16U 850 x 600 x 600
IP-304-D806080	IP-SSD806080	19"	16U	16U 850 x 600 x 800
IP-304-D1206040	IP-SSD1206040	19"	24U	24U 850 x 600 x 400
IP-304-D1206060	IP-SSD1206060	19"	24U	24U 1200 x 600 x 600
IP-304-D1206080	IP-SSD1206080	19"	24U	24U 1200 x 600 x 800
IP-304-D1606060	IP-SSD1606060	19"	32U	32U 1600 x 600 x 600
IP-304-D1606080	IP-SSD1606080	19"	32U	32U 1550 x 600 x 800
IP-304-D2006060	IP-SSD2006060	19"	42U	42U 1550 x 600 x 600
IP-304-D2006080	IP-SSD2006080	19"	42U	42U 2000 x 600 x 800



Heavy Duty IP55 19" Data Racks

Steel | Powder Coated

SD-HD

SINGLE DOOR | IP55



The IP Enclosures SD range of Heavy Duty IP55 19" Data Racks are designed for heavy duty outdoor applications to house sensitive data network equipment in harsh environments. They are suitable for internal and external installations.

Features & Specifications

IP Enclosures range of Heavy Duty IP55 19" Data Racks are designed for heavy duty outdoor applications to house sensitive data network equipment in harsh environments. They are suitable for internal and external installations. Heavy Duty Data Racks are constructed to withstand heavy loads associated with heavy equipment such as battery storage. Front and rear access doors are also provided.

Protection: IP55 IK10, NEMA 4  

Standard: IEC/EN/AS60529

Material:

- Enclosure Body: 1.5mm galvanised steel sheet
- Enclosure Doors: 1.5mm galvanised steel sheet
- 19" Data Rack Rails: 1.5mm galvanised steel sheet
- Enclosure Seal: Polyurethane

Body: The robust monoblock body is 1.5mm galvanised steel sheet. Precision automated manufacturing equipment ensures accuracy and consistent high quality. Flat face sealing surfaces increase seal life. A galvanised steel gland plate is also incorporated into the bottom face. The enclosure body and rails have been constructed to withstand heavy loads associated with heavy equipment such as heavy battery storage.

Doors: The front and rear surface mounted doors are 1.5mm galvanised steel sheet. They incorporate concealed removable hinges with captive pins. Doors are also designed for a 110° opening. Each door contains integral cable management rail studs and an M6 earth stud. The cable management rails are removable to provide more space for control components.

Door Seal: A high quality full perimeter seal provides excellent sealing over a long life. It is machine applied Polyurethane foamed in place (FIP).

Lock: 3 point locking system with key-lock swing handle. A full range of locking solutions are available upon request.

Gland Plate: Gland plates are incorporated into the bottom face of the enclosure for cable management. They are provided with gaskets and fasteners.

Surface Treatment: UL approved epoxy polyester powder coated with a textured finish. 80-120 micron average thickness. Standard Colour: RAL7035.
(Other colours available upon request).

Part Number	Size	No. of U (RU)	Cabinet Size	Type
SKU	19"	U/RU	U/RU H x W x D (mm)	
IP-SD1676080	19"	30U	30U 1670 x 600 x 800	Heavy Duty
IP-SD16712580	19" x 2 (Double Bay)	30U	30U 1670 x 1250 x 800	Heavy Duty
IP-SD16760100	19"	30U	30U 1670 x 600 x 1000	Heavy Duty
IP-SD1976080	19"	36U	36U 1970 x 600 x 800	Heavy Duty
IP-SD19712580	19" x 2 (Double Bay)	36U	36U 1970 x 1250 x 800	Heavy Duty
IP-SD19760100	19"	36U	36U 1970 x 600 x 1000	Heavy Duty



Accessories

19" Accessories

19" Data Rack Accessories



The IP Enclosures range of 19" rack-mounted DIN rail, distribution panels and shelves provide flexibility to fit DIN mounted electrical and control components into 19" racks.

Features & Specifications

19" Accessories

Standard: Compatible with 19" racks EIA-310-D, RoHS

1RU 19" Fixed Shelves

Part Number: IP-RCLF120
Depth: 200mm

Part Number: IP-RCLF130
Depth: 300mm

Part Number: IP-RCLF140
Depth: 400mm

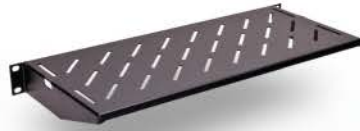

Can be used in either orientation

2RU 19" Fixed Shelves

Part Number: IP-RCLF240
Depth: 400mm

Part Number: IP-RCLF250
Depth: 500mm



Can be used in either orientation

3RU 19" Fixed Shelves

Part Number: IP-RCLF340
Depth: 400mm

Part Number: IP-RCLF350
Depth: 500mm

Part Number: IP-RCLF360
Depth: 600mm



Can be used in either orientation

1RU 19" Sliding Shelf

Part Number: IP-RCHF130
Depth: 225mm

Part Number: IP-RCHF140
Depth: 325mm



19" Rack Mounted Enclosure Bracket

Part Number: IP-RACKBRACKET4025-SET
Depth: 254.5mm

(1 Set = 2 x brackets as shown including fasteners)



Features & Specifications

19" Accessories

Standard: Compatible with 19" racks EIA-310-D, RoHS

Slotted Din Rail Material: Electrogalvanised Steel 7.5 x 35 RoHS Compliant. Standard 35mm wide symmetrical TS35 DIN Rail compatible with EN50022 and DIN46277-3.

1RU 19" DIN Terminal Rail

Part Number: IP-SDDINPANEL1

1RU 19" Cover Panel

Part Number: IP-SDCOVER1

1RU 19" Cover Panel (Ventilated)

Part Number: IP-EMH1



2RU 19" DIN Terminal Rail

Part Number: IP-SDDINPANEL2

2RU 19" Cover Panel

Part Number: IP-SDCOVER2

2RU 19" Cover Panel (Ventilated)

Part Number: IP-EMH2



3RU 19" DIN Terminal Rail

Part Number: IP-SDDINPANEL3

3RU 19" Cover Panel

Part Number: IP-SDCOVER3

3RU 19" Cover Panel (Ventilated)

Part Number: IP-EMH3



3RU 19" Distribution Board

Part Number: IP-SDDP3

(Supplied with Cover Panel)



1RU 19" DIN Rail Shelf - Single

Part Number: IP-SDDINSHELF1-150

1RU 19" DIN Rail Shelf - Double

Part Number: IP-SDDINSHELF1-250



Features & Specifications

19" Accessories

Standard: Compatible with 19" racks EIA-310-D, RoHS

4RU 19" Rack Mounted DIN Rail Housing

Part Number: IP-SDDINBOX4RU

4RU 19" Rack Mount Housing

Part Number: IP-SDBOX4RU



6RU 19" Rack Mounted DIN Rail Housing

Part Number: IP-SDDINBOX6RU

6RU 19" Rack Mount Housing

Part Number: IP-SDBOX6RU



8RU 19" Rack Mounted DIN Rail Housing

Part Number: IP-SDDINBOX8RU

8RU 19" Rack Mount Housing

Part Number: IP-SDBOX8RU



80mm Castors/Wheels

Part Number: IP-080RMB; IP-080FRMB

80mm Castors/Non-break Wheels/
Wheels with brake-Set of 2

Wheel Size: Ø80mm x 30mm Wide
Load Capacity: 120kg (Per wheel)



Adjustable Feet (Set of 4)

Part Number: IP-TAM10X70

1RU 19" Cable Organiser

Part Number: IP-RNG1U19

2RU 19" Cable Organiser

Part Number: IP-RNG2U19



Mounted Infrastructure Field Cabinets

Steel | Powder Coated

FC

SINGLE DOOR | IP66



Pole-mounted field cabinets house sensitive data network and electrical equipment for heavy duty outdoor applications including road/traffic management and intelligent transport systems.

Features & Specifications

Pole-Mounted infrastructure field cabinets are designed to house sensitive data network and electrical equipment for a variety of outdoor applications.

Protection: IP66 (Non-Ventilated range); IP55 (Ventilated Range)

Standard: IEC62208, IEC/EN/AS60529, EIA-310-D, RoHS  

Material:

- Body: 1.5mm galvanised steel sheet
- Door: 2.0mm galvanised steel sheet
- 19" Data Rack Rails: 1.5mm galvanised steel sheet (IP-706032 & IP-706032-0 only)
- Enclosure Seal: Polyurethane

Body: The robust monoblock body is fabricated using 1.5mm galvanised steel sheet. Flat face sealing surfaces increase seal life. Pre-fitted blind nutserts are incorporated to accommodate pole mount bracket to eliminate drilling and retain IP rating. Integral device plate mounts and M6 earth stud are included. Fan/filter cutouts and hinged vent hoods are provided as standard. Non-ventilated option is also available. (Fans and filters are ordered separately).

Door: The front door is fabricated using 2.0mm galvanised steel sheet and is designed to provide flush recessed mounting to prevent vandalism and unauthorised access. The door incorporates concealed removable hinges with captive pins. It is hinged on the left side and is provided with a heavy duty door stay. An A4 plan pocket is provided.

19" Data Rack Rails: Front and rear 19" data rack rails are fabricated from 1.5mm galvanised steel sheet.

Door Seals: Polyurethane foamed in place (FIP) full perimeter door seals provide excellent sealing over a long life. Temperature resistance: -40°C to 80°C.

Locks: 3 point locking system with key-lock swing handle. Optional locking including half euro keyed as required, restricted keys, Bilock, etc.

Surface Treatment: UL approved epoxy polyester powder coated with a smooth finish. 80-120 micron average thickness. Colour RAL7035 Light Grey. RAL6005 Moss Green is also available upon request.

Accessory: Optional Pole Mount Bracket (One-piece, full height).
Optional Base: 600mm high base, flush to suit width and depth of field cabinet. Powder coated, colour RAL7035 Light Grey. RAL6005 Moss Green is also available upon request.



Ventilated	Non-Ventilated	Description	Optional Pole Mount Bracket	Optional Base (600mm high)
Part Number/SKU	Part Number/SKU	U/RU H x W x D	Part Number/SKU	Part Number/SKU
IP-453522	IP-453522-0	450H x 350W x 225D	IP-PMB45	IP-FCBASE3522
IP-654532	IP-654532-0	650H x 450W x 325D	IP-PMB65	IP-FCBASE4532
IP-706032	IP-706032-0	12RU x 600W x 325D	IP-PMB70	IP-FCBASE6032

*Available in RAL6005 Moss Green upon request.

Mounted Infrastructure Field Cabinets

Marine Grade Aluminium | Powder Coated

FCA

SINGLE DOOR | IP66



Marine grade aluminium pole-mounted field cabinets house sensitive data network and electrical equipment for outdoor applications including road/traffic management and intelligent transport systems.

Features & Specifications

Marine grade aluminium pole-mounted infrastructure field cabinets are designed to house sensitive data network and electrical equipment for a variety of harsh outdoor applications.

Protection: IP66 (Non-Ventilated range); IP55 (Ventilated Range)

Standard: IEC62208, IEC/EN/AS60529, EIA-310-D, RoHS  

Material:

- Body: 2.5mm Marine Grade Aluminium 5754-H111
- Door: 2.5mm Marine Grade Aluminium 5754-H111
- 19" Data Rack Rails: 1.5mm galvanised steel sheet (IP-A706032 & IP-A706032-0 only)
- Enclosure Seal: Polyurethane

Body: The robust monoblock body is fabricated using 2.5mm marine grade aluminium. Flat face sealing surfaces increase seal life. Pre-fitted blind nutserts are incorporated to accommodate pole mount bracket to eliminate drilling and retain IP rating. Integral device plate mounts and M6 earth stud are included. Fan/filter cutouts and hinged vent hoods are provided as standard. Non-ventilated option is also available. (Fans and filters are ordered separately).

Door: The front door is fabricated using 2.5mm marine grade aluminium and is designed to provide flush recessed mounting to prevent vandalism and unauthorised access. The door incorporates concealed removable hinges with captive pins. It is hinged on the left side and is provided with a heavy duty door stay. An A4 plan pocket is provided.

19" Data Rack Rails: Front and rear 19" data rack rails are fabricated from 1.5mm galvanised steel sheet.

Door Seals: Polyurethane foamed in place (FIP) full perimeter door seals provide excellent sealing over a long life. Temperature resistance: -40°C to 80°C.

Locks: 3 point locking system with key-lock swing handle. Optional locking including half euro keyed as required, restricted keys, Bilock, etc.

Surface Treatment: UL approved epoxy polyester powder coated with a smooth finish. 80-120 micron average thickness. Colour RAL7035 Light Grey. RAL6005 Moss Green is also available upon request.

Accessory: Optional Pole Mount Bracket (One-piece, full height).
Optional Base: 600mm high base, flush to suit width and depth of field cabinet. Powder coated, colour RAL7035 Light Grey. RAL6005 Moss Green is also available upon request.



Ventilated	Non-Ventilated	Description	Optional Pole Mount Bracket	Optional Base (600mm high)
Part Number/SKU	Part Number/SKU	U/RU H x W x D	Part Number/SKU	Part Number/SKU
IP-A453522	IP-A453522-0	450H x 350W x 225D	IP-APMB45	IP-AFCBASE3522
IP-A654532	IP-A654532-0	650H x 450W x 325D	IP-APMB65	IP-AFCBASE4532
IP-A706032	IP-A706032-0	12RU x 600W x 325D	IP-APMB70	IP-AFCBASE6032

*Available in RAL6005 Moss Green upon request.

Infrastructure Field Cabinets

FC

Steel | Powder Coated

IP66 (NON-VENTILATED) | IP55 (VENTILATED)



Field cabinets house sensitive data network and electrical equipment for heavy duty outdoor applications including road/traffic management and intelligent transport systems.

Features & Specifications

Infrastructure field cabinets are designed to house sensitive data network and electrical equipment for a variety of outdoor applications.

Protection: IP66 (Non-Ventilated range); IP55 (Ventilated Range)

Standard: IEC62208, IEC/EN/AS60529, EIA-310-D, RoHS  

Material:

- Body and Plinth: 2.0mm galvanised steel sheet
- Doors: 2.0mm galvanised steel sheet
- 19" Data Rack Rails: 1.5mm galvanised steel sheet
- Gland Plate: 3.0mm aluminium
- Enclosure Seal: Polyurethane

Body: The robust monoblock body is fabricated using 2.0mm galvanised steel. The body is fitted with rain hood/sunshield, plinth, vent hoods and 4 x lifting eye bolts. Flat face sealing surfaces are provided to increase seal life. A split gland plate is incorporated into the base. Four cutouts 125mm x 125mm are provided to house fans and filters and each are covered with removable vent hoods.

Doors: The front and rear doors are fabricated using 2.0mm galvanised steel sheet and are designed to provide flush recessed mounting to prevent vandalism and unauthorised access. The doors incorporate concealed removable hinges with captive pins. They are provided with heavy duty door stays.

19" Data Rack Rails: Front and rear 19" data rack rails are fabricated from 1.5mm galvanised steel sheet.

Door Seals: Polyurethane foamed in place (FIP) full perimeter door seals provide excellent sealing over a long life. Temperature resistance: -40°C to 80°C.

Locks: Each door includes a 3 point locking system with key-lock swing handle. Optional locking including half euro keyed as required, restricted keys, Bilock, etc.

Gland Plate: 3mm aluminium split gland plates are incorporated into the base.

Surface Treatment: UL approved epoxy polyester powder coated with a smooth finish. 80-120 micron average thickness. Colour RAL7035 Light Grey. RAL6005 Moss Green is also available upon request.

Ventilated	Non-Ventilated	Description
Part Number/SKU	Part Number/SKU	U/RU H x W x D
IP-1077562	IP-1077562-0	18U 1075H x 750W x 620D
IP-1077580	IP-1077580-0	18U 1075H x 750W x 800D
IP-1377562	IP-1377562-0	24U 1375H x 750W x 620D
IP-1377580	IP-1377580-0	24U 1375H x 750W x 800D
IP-13775100	IP-13775100-0	24U 1375H x 750W x 1000D
IP-1677562	IP-1677562-0	30U 1675H x 750W x 620D
IP-1677580	IP-1677580-0	30U 1675H x 750W x 800D
IP-16775100	IP-16775100-0	30U 1675H x 750W x 1000D
IP-1977562	IP-1977562-0	36U 1975H x 750W x 620D
IP-1977580	IP-1977580-0	36U 1975H x 750W x 800D
IP-19775100	IP-19775100-0	36U 1975H x 750W x 1000D
IP-2277562	IP-2277562-0	42U 2275H x 750W x 620D
IP-2277580	IP-2277580-0	42U 2275H x 750W x 800D

*Available in RAL6005 Moss Green upon request.



Infrastructure Field Cabinets

FCA

Marine Grade Aluminium | Powder Coated

IP66 (NON-VENTILATED) | IP55 (VENTILATED) | OPTIONAL DOUBLE WALL





Field cabinets house sensitive data network and electrical equipment for heavy duty outdoor applications including road/traffic management and intelligent transport systems.

Features & Specifications

Marine grade aluminium infrastructure field cabinets are designed to house sensitive data network and electrical equipment for a variety of outdoor applications.

Protection: IP66 (Non-Ventilated range); IP55 (Ventilated Range)

Standard: IEC62208, IEC/EN/AS60529, EIA-310-D, RoHS  

Material:

- Body and Plinth: 2.5mm Marine Grade Aluminium 5754-H111
- Doors: 2.5mm Marine Grade Aluminium 5754-H111
- 19" Data Rack Rails: 1.5mm galvanised steel sheet
- Gland Plate: 3.0mm Aluminium
- Enclosure Seal: Polyurethane

Body: The robust monoblock body is fabricated using 2.5mm marine grade aluminium. The body is fitted with rain hood/sunshield, plinth, vent hoods and 4 x lifting eye bolts. Flat face sealing surfaces are provided to increase seal life. A split gland plate is also incorporated into the base. Four cutouts 125mm x 125mm are provided to house fans and filters and each are covered with removable vent hoods.

Doors: The front and rear doors are fabricated using 2.5mm marine grade aluminium and are designed to provide flush recessed mounting to prevent vandalism and unauthorised access. The doors incorporate concealed removable hinges with captive pins. They are provided with heavy duty door stays.

NOTE: Double Wall option available. Refer to table below.

19" Data Rack Rails: Front and rear 19" data rack rails are fabricated from 1.5mm galvanised steel sheet.

Door Seals: Polyurethane foamed in place. Temperature resistance: -40°C to 80°C.

Locks: Each door includes a 3 point locking system with key-lock swing handle. Optional locking including half euro keyed as required, restricted keys, Bilock etc.

Gland Plate: 3mm aluminium split gland plates are incorporated into the base.

Surface Treatment: UL approved epoxy polyester powder coated with a smooth finish. 80-120 micron average thickness. Colour RAL7035 Light Grey.

RAL6005 Moss Green is also available upon request.

Ventilated	Non-Ventilated	Double Wall (Ventilated)	Description
Part Number/SKU	Part Number/SKU	Part Number/SKU	U/RU H x W x D
IP-A1077562	IP-A1077562-0	IP-A1077562-2	18U 1075H x 750W x 620D
IP-A1077580	IP-A1077580-0	IP-A1077580-2	18U 1075H x 750W x 800D
IP-A1377562	IP-A1377562-0	IP-A1377562-2	24U 1375H x 750W x 620D
IP-A1377580	IP-A1377580-0	IP-A1377580-2	24U 1375H x 750W x 800D
IP-A13775100	IP-A13775100-0	IP-A13775100-2	24U 1375H x 750W x 1000D
IP-A1677562	IP-A1677562-0	IP-A1677562-2	30U 1675H x 750W x 620D
IP-A1677580	IP-A1677580-0	IP-A1677580-2	30U 1675H x 750W x 800D
IP-A16775100	IP-A16775100-0	IP-A16775100-2	30U 1675H x 750W x 1000D
IP-A1977562	IP-A1977562-0	IP-A1977562-2	36U 1975H x 750W x 620D
IP-A1977580	IP-A1977580-0	IP-A1977580-2	36U 1975H x 750W x 800D
IP-A19775100	IP-A19775100-0	IP-A19775100-2	36U 1975H x 750W x 1000D
IP-A2277562	IP-A2277562-0	IP-A2277562-2	42U 2275H x 750W x 620D
IP-A2277580	IP-A2277580-0	IP-A2277580-2	42U 2275H x 750W x 800D

*Available in RAL6005 Moss Green upon request.



Infrastructure Field Cabinets

Steel | Powder Coated

FC

DOUBLE BAY | IP66 (NON-VENTILATED) | IP55 (VENTILATED)



IP Enclosures infrastructure field cabinets are available in ventilated and non-ventilated double bay configurations.

Features & Specifications

IP Enclosures Infrastructure field cabinets are available in ventilated and non-ventilated double bay configurations.

DOUBLE BAY

Protection: IP66 (Non-Ventilated range); IP55 (Ventilated range)

Standard: IEC62208, IEC/EN/AS60529, EIA-310-D, RoHS 

Materials:

- Body and Plinth: 2.0mm galvanised steel sheet
- Doors: 2.0mm galvanised steel sheet
- 19" Data Rack Rails: 1.5mm galvanised steel sheet
- Gland Plate: 3.0mm aluminium
- Enclosure Seal: Polyurethane

Body: The robust monoblock body is fabricated using 2.0mm galvanised steel. The body is fitted with rain hood/sunshield, plinth, vent hoods and 4 x lifting eye bolts. Flat face sealing surfaces are provided to increase seal life. A split gland plate is incorporated into the base. Four cutouts 125mm x 125mm are provided to house fans and filters and each are covered with removable vent hoods.

Doors: The front and rear doors are fabricated using 2.0mm galvanised steel sheet and are designed to provide flush recessed mounting to prevent vandalism and unauthorised access. The doors incorporate concealed removable hinges with captive pins. They are provided with heavy duty door stays.

19" Data Rack Rails: Front and rear 19" data rack rails are fabricated from 1.5mm galvanised steel sheet.

Door Seals: Polyurethane foamed in place (FIP) full perimeter door seals provide excellent sealing over a long life. Temperature resistance: -40°C to 80°C.

Locks: Each door includes a 3 point locking system with key-lock swing handle.

Gland Plate: 3mm aluminium split gland plates are incorporated into the base.

Surface Treatment: UL approved epoxy polyester powder coated with a smooth finish. 80-120 micron average thickness. Colour RAL7035 Light Grey. RAL6005 Moss Green is also available upon request.



(Shelves not included)

Ventilated	Non-Ventilated	Description
Part Number/SKU	Part Number/SKU	U/RU H x W x D
IP-10715062	IP-10715062-0	2 x 18U (36U) Field Cabinet 1075H x 1500W x 620D
IP-10715080	IP-10715080-0	2 x 18U (36U) Field Cabinet 1075H x 1500W x 800D
IP-13715062	IP-13715062-0	2 x 24U (48U) Field Cabinet 1375H x 1500W x 620D
IP-13715080	IP-13715080-0	2 x 24U (48U) Field Cabinet 1375H x 1500W x 800D
IP-16715062	IP-16715062-0	2 x 30U (60U) Field Cabinet 1675H x 1500W x 620D
IP-16715080	IP-16715080-0	2 x 30U (60U) Field Cabinet 1675H x 1500W x 800D

*Available in RAL6005 Moss Green upon request.

Infrastructure Field Cabinets

FCA

Marine Grade Aluminium | Powder Coated

DOUBLE BAY | IP66 (NON-VENTILATED) | IP55 (VENTILATED)



Marine grade aluminium infrastructure field cabinets are available in ventilated and non-ventilated double bay configurations.

Features & Specifications

Marine grade aluminium infrastructure field cabinets are available in ventilated and non-ventilated double bay configurations.

DOUBLE BAY

Protection: IP66 (Non-Ventilated range); IP55 (Ventilated range)

Standard: IEC62208, IEC/EN/AS60529, EIA-310-D, RoHS  

Material:

- Body and Plinth: 2.5mm Marine Grade Aluminium 5754-H111
- Doors: 2.5mm Marine Grade Aluminium 5754-H111
- 19" Data Rack Rails: 1.5mm galvanised steel sheet
- Gland Plate: 3.0mm Aluminium
- Enclosure Seal: Polyurethane

Body: The robust monoblock body is fabricated using 2.5mm marine grade aluminium. The body is fitted with rain hood/sunshield, plinth, vent hoods and 4 x lifting eye bolts. Flat face sealing surfaces are provided to increase seal life. A split gland plate is also incorporated into the base. Four cutouts 125mm x 125mm are provided to house fans and filters and each are covered with removable vent hoods.

Doors: The front and rear doors are fabricated using 2.5mm marine grade aluminium and are designed to provide flush recessed mounting to prevent vandalism and unauthorised access. The doors incorporate concealed removable hinges with captive pins. They are provided with heavy duty door stays.

19" Data Rack Rails: Front and rear 19" data rack rails are fabricated from 1.5mm galvanised steel sheet.

Door Seals: Polyurethane foamed in place. Temperature resistance: -40°C to 80°C.

Locks: Each door includes a 3 point locking system with key-lock swing handle.

Gland Plate: 3mm aluminium split gland plates are incorporated into the base.

Surface Treatment: UL approved epoxy polyester powder coated with a smooth finish. 80-120 micron average thickness. Colour RAL7035 Light Grey. RAL6005 Moss Green is also available upon request.

NOTE: Double Wall option available. Refer to table below.



(Shelves not included)

Ventilated	Non-Ventilated	Double Wall (Ventilated)	Description
Part Number/SKU	Part Number/SKU	Part Number/SKU	U/RU H x W x D
IP-A10715062	IP-A10715062-0	IP-A10715062-2	2 x 18U (36U) 1075H x 1500W x 620D
IP-A10715080	IP-A10715080-0	IP-A10715080-2	2 x 18U (36U) 1075H x 1500W x 800D
IP-A13715062	IP-A13715062-0	IP-A13715062-2	2 x 24U (48U) 1375H x 1500W x 620D
IP-A13715080	IP-A13715080-0	IP-A13715080-2	2 x 24U (48U) 1375H x 1500W x 800D
IP-A16715062	IP-A16715062-0	IP-A16715062-2	2 x 30U (60U) 1675H x 1500W x 620D
IP-A16715080	IP-A16715080-0	IP-A16715080-2	2 x 30U (60U) 1675H x 1500W x 800D

*Available in RAL6005 Moss Green upon request.

Outdoor Field Cabinets

Steel | Powder Coated

FC

IP66 (NON-VENTILATED) | IP55 (VENTILATED) | IP33 (LOUVRED)



IP Enclosures FC Range of 19" Outdoor Field Cabinets are designed for heavy duty outdoor applications to house sensitive data network and electrical equipment in harsh environments.

Features & Specifications

IP Enclosures FC Range of 19" Outdoor Field Cabinets are designed for heavy duty outdoor applications to house sensitive data network and electrical equipment in harsh environments. They are suitable for a variety of outdoor applications including road and rail transport management systems and general data and network infrastructure applications.

Protection: IP66 IK10 NEMA 4 (Non-Ventilated), IP55 (Ventilated), IP33 (Louvred)

Standard: IEC62208, IEC/EN/AS60529, EIA-310-D  

Rack Unit Size: 12U, 18U, 24U

Material:

- Body and Plinth: 2.0mm galvanised steel sheet
- Door: 2.0mm galvanised steel sheet
- 19" Data Rack Rails: 1.5mm galvanised steel sheet
- Gland Plate: 3.0mm aluminium
- Enclosure Seal: Polyurethane

Body: The robust monoblock body is fabricated using 2.0mm galvanised steel. The body is fitted with rain hood/sunshield and plinth. Flat face sealing surfaces are provided to increase seal life. A 3mm galvanised steel split gland plate is also incorporated into the bottom face.

Base: The base is 150mm high and fabricated using a 2.0mm galvanised steel sheet.

Doors: The door is fabricated using 2.0mm galvanised steel sheet and is designed to provide flush recessed mounting to prevent vandalism and unauthorised access. The door incorporates concealed removable hinges with captive pins. It is designed for a 110° opening and is provided with heavy duty door stays.

19" Data Rack Rails: Front and rear 19" data rack rails are fabricated from 1.5mm galvanised steel sheet.

Seal: A high quality full perimeter Polyurethane foamed in place (FIP) seal provides excellent sealing over a long life.

Locks: 8mm Square Grade 316 Stainless Steel.

Surface Treatment: UL approved epoxy polyester powder coated with a smooth finish. 80-120 micron average thickness. Colour RAL6005 Moss Green.



Ventilated	Non-Ventilated	Louvred	Cabinet Size
Part Number/SKU	Part Number/SKU	Part Number/SKU	U/RU H x W x D (mm)
IP-12U6545-GRN	IP-12U6545-0-GRN	IP-12U6545-LVR-GRN	12U IP66 19" 650W x 450D Outdoor Field Cabinet
IP-18U6545-GRN	IP-18U6545-0-GRN	IP-18U6545-LVR-GRN	18U IP66 19" 650W x 450D Outdoor Field Cabinet
IP-18U6560-GRN	IP-18U6560-0-GRN	IP-18U6560-LVR-GRN	18U IP66 19" 650W x 600D Outdoor Field Cabinet
IP-24U13060-GRN	IP-24U13060-0-GRN	IP-24U13060-LVR-GRN	24U IP66 19" 650W x 600D Outdoor Field Cabinet

Outdoor Field Cabinets

Steel | Powder Coated

FC

DOUBLE BAY | IP66 (NON-VENTILATED) | IP55 (VENTILATED) | IP33 (LOUVRED)



IP Enclosures FC Range of 19" Outdoor Field Cabinets are designed for heavy duty outdoor applications to house sensitive data network and electrical equipment in harsh environments.

Features & Specifications

IP Enclosures FC Range of 19" Outdoor Field Cabinets are designed for heavy duty outdoor applications to house sensitive data network and electrical equipment in harsh environments. They are suitable for a variety of outdoor applications including road and rail transport management systems and general data and network infrastructure applications.

DOUBLE BAY

Protection: IP66 IK10 NEMA 4 (Non-Ventilated), IP55 (Ventilated), IP33 (Louvred)

Standard: IEC62208, IEC/EN/AS60529, EIA-310-D 

Rack Unit Size: 12U, 18U, 24U

Material:

- Body and Plinth: 2.0mm galvanised steel sheet
- Door: 2.0mm galvanised steel sheet
- 19" Data Rack Rails: 1.5mm galvanised steel sheet
- Gland Plate: 3.0mm aluminium
- Enclosure Seal: Polyurethane

Body: The robust monoblock body is fabricated using 2.0mm galvanised steel. The body is fitted with rain hood/sunshield and plinth. Flat face sealing surfaces are provided to increase seal life. A 3mm galvanised steel split gland plate is also incorporated into the bottom face.

Base: The base is 150mm high and fabricated using a 2.0mm galvanised steel sheet.

Doors: The door is fabricated using 2.0mm galvanised steel sheet and is designed to provide flush recessed mounting to prevent vandalism and unauthorised access. The door incorporates concealed removable hinges with captive pins. It is designed for a 110° opening and is provided with heavy duty door stays.

19" Data Rack Rails: Front and rear 19" data rack rails are fabricated from 1.5mm galvanised steel sheet.

Seal: A high quality full perimeter Polyurethane foamed in place (FIP) seal provides excellent sealing over a long life.

Locks: 8mm Square Grade 316 Stainless Steel.

Surface Treatment: UL approved epoxy polyester powder coated with a smooth finish. 80-120 micron average thickness. Colour RAL6005 Moss Green.



Ventilated	Non-Ventilated	Louvred	Cabinet Size
Part Number/SKU	Part Number/SKU	Part Number/SKU	U/RU H x W x D (mm)
IP-2X12U6545-GRN	IP-2X12U6545-0-GRN	IP-2X12U6545-LVR-GRN	2 x 12U (24U) IP66 19" 1300W x 450D Double Bay Outdoor Field Cabinet
IP-2X18U6560-GRN	IP-2X18U6560-0-GRN	IP-2X18U6560-LVR-GRN	2 x 18U (36U) IP66 19" 1300W x 600D Double Bay Outdoor Field Cabinet
IP-2X24U13060-GRN	IP-2X24U13060-0-GRN	IP-2X24U13060-LVR-GRN	2 x 24U (48U) IP66 19" 1300W x 600D Double Bay Outdoor Field Cabinet

Air Conditioned Field Cabinets

Steel | Powder Coated

FC



IP Enclosures Air-Conditioned Field Cabinets are designed to house and cool sensitive data network and electrical equipment in harsh environments. They are rated IP55 and designed to prevent unauthorised access and vandalism while keeping contents cool to ensure protection in the toughest conditions.

Features & Specifications

IP Enclosures FC range of steel powder coated air-conditioned field cabinets are designed to house and cool equipment in harsh environments. They are rated IP55 and designed to prevent unauthorised access while keeping contents cool by incorporating an internally-mounted air conditioner. The air conditioner is housed in a separate compartment and is accessible via a recessed side door with louvered vent hood to enhance air flow. The cooled 19" rack compartment is rated to IP55, accessible via front and rear doors.

Protection: IP55 (Inside main 19" rack compartment)

Standard: IEC62208, IEC/EN/AS60529, EIA-310-D 

Material:

- Body and Plinth: 2.0mm Galvanised steel sheet
- Doors: 2.0mm Galvanised steel sheet
- 19" Data Rack Rails: 1.5mm Galvanised steel sheet
- Gland Plate: 3.0mm Aluminium
- Enclosure Seal: Polyurethane

Body: The robust monoblock body is fabricated using 2.0mm galvanised steel sheet. The body is fitted with rainhood, sunshield, plinth, and 4 x lifting eye bolts. Flat face sealing surfaces are provided to increase seal life. A 3.0mm aluminium split gland plate is also incorporated into the bottom face. A segmented compartment is provided to house the air conditioner.

Doors: The front, rear, and side doors are fabricated using 2.0mm galvanised steel sheet and are designed to provide flush recessed mounting to prevent vandalism and unauthorised access. The doors incorporate concealed removable hinges with captive pins. They are designed for a 110° opening and are provided with heavy duty door stays.

19" Data Rack Rails: Front and rear 19" data rack rails are fabricated from 1.5mm galvanised steel sheet.

Seals: High quality Polyurethane foamed in place (FIP) full perimeter door seals.

Locks: Each door includes a 3-point locking system with key-lock swing handle.

Gland Plate: 3.0mm aluminium split gland plates are incorporated into the bottom of the enclosure for cable management.

Surface Treatment: UL approved epoxy polyester powder coated with a smooth finish. 80-120 micron average thickness. Colour RAL7035 Light Grey. RAL6005 Moss Green is also available upon request.

Air Conditioner:

IP Enclosures SAA approved compact air conditioners are designed for the cooling needs of outdoor electrical cabinets. They have been designed for high efficiency and low maintenance and include a condenser fan controller and pressure controller for the compressor.

Standards: AS/NZS 60335.2.40:2019, AS/NZS 60335.1:2020.

Approval Marks: SAA203165

Ventilated	Description
Part Number/SKU	U/RU H x W x D
IP-1079062-ACO35	18U IP55 Field Cabinet 1075H x 900W x 620D for 0.35kW Air Conditioner
IP-1379062-ACO85	24U IP55 Field Cabinet 1375H x 900W x 620D for 0.85kW Air Conditioner
IP-1679080-AC145	30U IP55 Field Cabinet 1675H x 900W x 800D for 1.45kW Air Conditioner
IP-1979080-AC145	36U IP55 Field Cabinet 1975H x 900W x 800D for 1.45kW Air Conditioner
IP-2279080-AC200	42U IP55 Field Cabinet 2275H x 900W x 800D for 2.00kW Air Conditioner

*Available in RAL6005 Moss Green upon request.



Air Conditioned Field Cabinets

FCA

Marine Grade Aluminium | Powder Coated



IP Enclosures Air-Conditioned Field Cabinets are designed to house and cool sensitive data network and electrical equipment in harsh environments. They are rated IP55 and designed to prevent unauthorised access and vandalism while keeping contents cool to ensure protection in the toughest conditions.

Features & Specifications

IP Enclosures FC range of marine grade aluminium powder coated air conditioned field cabinets are designed to house and cool equipment in harsh environments. They are rated IP55 and designed to prevent unauthorised access while keeping contents cool by incorporating an internally-mounted air conditioner. The air conditioner is housed in a separate compartment and is accessible via a recessed side door with louvered vent hood to enhance air flow. The cooled 19" rack compartment is rated to IP55, accessible via front and rear doors.

Protection: IP55 (Inside main 19" rack compartment)

Standard: IEC62208, IEC/EN/AS60529, EIA-310-D  

Material:

- Body and Plinth: 2.5mm Marine Grade Aluminium sheet
- Doors: 2.5mm Marine Grade Aluminium sheet
- 19" Data Rack Rails: 1.5mm Galvanised steel sheet
- Gland Plate: 3.0mm Aluminium
- Enclosure Seal: Polyurethane

Body: The robust monoblock body is fabricated using 2.0mm galvanised steel sheet. The body is fitted with rainhood, sunshield, plinth, and 4 x lifting eye bolts. Flat face sealing surfaces are provided to increase seal life. A 3.0mm aluminium split gland plate is also incorporated into the bottom face. A segmented compartment is provided to house the air conditioner.

Doors: The front and rear doors are fabricated using 2.0mm galvanised steel sheet and are designed to provide flush recessed mounting to prevent vandalism and unauthorised access. The doors incorporate concealed removable hinges with captive pins. They are designed for a 110° opening and are provided with heavy duty door stays.

19" Data Rack Rails: Front and rear 19" data rack rails are fabricated from 1.5mm galvanised steel sheet.

Seals: High quality Polyurethane foamed in place (FIP) full perimeter door seals.

Locks: Each door includes a 3-point locking system with key-lock swing handle.

Gland Plate: 3.0mm aluminium split gland plates are incorporated into the bottom of the enclosure for cable management.

Surface Treatment: UL approved epoxy polyester powder coated with a smooth finish. 80-120 micron average thickness. Colour RAL7035 Light Grey. RAL6005 Moss Green is also available upon request.

Air Conditioner:

IP Enclosures SAA approved compact air conditioners are designed for the cooling needs of outdoor electrical cabinets. They have been designed for high efficiency and low maintenance and include a condenser fan controller and pressure controller for the compressor.

Standards: AS/NZS 60335.2.40:2019, AS/NZS 60335.1:2020.

Approval Marks: SAA203165

Ventilated	Description
Part Number/SKU	U/RU H x W x D
IP-A1079062-ACO35	18U IP55 Aluminium Field Cabinet 1075H x 900W x 620D for 0.35kW Air Conditioner
IP-A1379062-ACO85	24U IP55 Aluminium Field Cabinet 1375H x 900W x 620D for 0.85kW Air Conditioner
IP-A1679080-AC145	30U IP55 Aluminium Field Cabinet 1675H x 900W x 800D for 1.45kW Air Conditioner
IP-A1979080-AC145	36U IP55 Aluminium Field Cabinet 1975H x 900W x 800D for 1.45kW Air Conditioner
IP-A2279080-AC200	42U IP55 Aluminium Field Cabinet 2275H x 900W x 800D for 2.00kW Air Conditioner

*Available in RAL6005 Moss Green upon request.



Accessories

Infrastructure Field Cabinets

Fixed Shelf Kits

Fixed shelf kits have many uses and can be used for component storage and battery storage. Shelves are ventilated. They are provided with fasteners and can be easily fitted without drilling.

Material: Galvanised steel sheet.

Surface Treatment: UL approved epoxy polyester powder coated with a textured finish. 80-120 micron average thickness. Colour RAL7035.

Part Number/SKU	Description	Shelf Rating
IP-FCSHL7562	Light Duty Shelf to suit 750W x 620D Field Cabinet	50kg
IP-FCSHH7562	Heavy Duty Shelf to suit 750W x 620D Field Cabinet	250kg
IP-FCSHH7580	Heavy Duty Shelf to suit 750W x 800D Field Cabinet	250kg

**Available in RAL6005 Moss Green upon request.*



Sliding Shelf Kits (Laptop Drawers)

Sliding shelf kits (Laptop drawer kits) are provided assembled complete with 4 screws for fast and easy fitting without drilling.

Material: Galvanised steel sheet.

Surface Treatment: UL approved epoxy polyester powder coated with a textured finish. 80-120 micron average thickness. Colour RAL7035.

Part Number/SKU	Description	Shelf Rating
IP-FCDRAWER620	Laptop Drawer to suit 750W x 620D Field Cabinet	25kg
IP-FCDRAWER800	Laptop Drawer to suit 750W x 800D Field Cabinet	25kg

**Available in RAL6005 Moss Green upon request.*



General Accessories

Device mounting plates, document storage pockets and cage nuts:

Part Number/SKU	Description
IP-12RUDP	12U Rack Mounted Device Mounting Plate
IP-18RUDP	18U Rack Mounted Device Mounting Plate
IP-13762DP	Device Plate for 1375H x 620D Field Cabinet (Side Mount)
IP-16762DP	Device Plate for 1675H x 620D Field Cabinet (Side Mount)
IP-19762DP	Device Plate for 1975H x 620D Field Cabinet (Side Mount)
IP-FCPPA4	A4 Document Storage Pocket
IP-M6SCREW-CAGENUT	M6 Cage Nut & Screw (Pack of 50)

**Available in RAL6005 Moss Green upon request.*



Accessories

Infrastructure Field Cabinets

Pedestal Bases

Pedestal Bases are available to suit pole-mounted field cabinets. This enables pole-mounted field cabinets to be floor-mounted.

Material: Galvanised steel sheet | Marine grade aluminium

Surface Treatment: UL approved epoxy polyester powder coated with a textured finish. 80-120 micron average thickness. Colour RAL7035.

STEEL		ALUMINIUM	Description
Part Number/SKU	Part Number/SKU	Part Number/SKU	
IP-FCBASE3522	IP-FCABASE3522	IP-FCABASE3522	600H Pedestal Base to suit 350W x 225D Field Cabinet RAL7035 Grey
IP-FCBASE4532	IP-FCABASE4532	IP-FCABASE4532	600H Pedestal Base to suit 450W x 325D Field Cabinet RAL7035 Grey
IP-FCBASE6032	IP-FCABASE6032	IP-FCABASE6032	600H Pedestal Base to suit 600W x 325D Field Cabinet RAL7035 Grey

**Available in RAL6005 Moss Green upon request.*



Pole-Mount Brackets

Pole-Mount Brackets are provided with holes and fasteners to attach bracket to the encapsulated threaded nutserts in the back of the field cabinet.

Material: Galvanised steel sheet | Grade 304 Stainless Steel (For Aluminium Field Cabinets)

Surface Treatment: UL approved epoxy polyester powder coated with a textured finish. 80-120 micron average thickness.

STEEL		304SS (For Aluminium Field Cabinets)	Description
Part Number/SKU	Part Number/SKU	Part Number/SKU	
IP-PMB45	IP-APMB45	IP-APMB45	To suit 450H x 350W x 225D Field Cabinet
IP-PMB65	IP-APMB65	IP-APMB65	To suit 650H x 450W x 325D Field Cabinet
IP-PMB70	IP-APMB70	IP-APMB70	To suit 12U x 600W x 325D Field Cabinet

**Available in RAL6005 Moss Green upon request.*





Protection in the toughest conditions™

IP69K **Hygienic Electrical Enclosures**
Food Beverage & Pharmaceutical

IP69K Hygienic Electrical Enclosures

H

Stainless Steel Grade 304

SLOPING ROOF | SINGLE DOOR | HYGIENIC FOOD GRADE | IP69K



The IP Enclosures H range of IP69K food grade electrical enclosures are designed for applications within the food & beverage, pharmaceutical and other industries that require high hygienic standards.

Features & Specifications

IP69K food grade electrical enclosures are designed to prevent contamination and are suitable for the food & beverage, pharmaceutical and other industries that require high hygienic standards.

Protection: IP66 IK07, IP69K

Standard: DGUV EN1672-2, EN62208, EN/AS60529, ISO20653, UL508A EHEDG



Material:

- Body: 1.5mm Grade 304 Stainless Steel
- Door: 1.5mm Grade 304 Stainless Steel
- Device Mounting Plate: Galvanised Steel Sheet (Optional: Stainless Steel)
- Seal: Blue Silicone FDA compliant

Body: The robust monoblock body with 30° sloping roof is fabricated using 1.5mm Grade 304 Stainless Steel. It is designed to be completely smooth and without crevices and without concave angles to facilitate cleaning and avoid deposits. The body is designed to promote self draining for ease of hygienic cleaning.

Door: The door is fabricated using 1.5mm Grade 304 Stainless Steel and includes specially cast internal hinges to allow for removal of the seals. The door is designed for a 115° opening with hinges on the right hand side.

Seal: Blue silicone seal, FDA compliant for food production areas.

Lock: IP69K Stainless Steel Hygiene lock with seal. Dirt resistant and easy to clean.

Device Mounting Plate: Fabricated using galvanised steel sheet. Supplied fitted.

Floor Standing Cabinets: Cabinets marked with an asterisk "*" below are provided with a base with adjustable feet.

Accessories: Hygienic Spacer Bracket Kit. SKU: IP-HSB-KIT (Set of 4)



Part Number	Enclosure Size	Overall Height	Device Plate	Locks	Mass
SKU	H x W x D (mm)	H2 (mm)	H x W (mm)	Qty	Kg
IP-H302015	300 x 200 x 150	388	245 x 145	1	7.5
IP-H453821	450 x 380 x 210	570	395 x 325	2	12.5
IP-H453830	450 x 380 x 300	622	395 x 325	1	18
IP-H603821	600 x 380 x 300	720	545 x 325	2	20.5
IP-H605021	600 x 500 x 210	720	545 x 445	2	21.5
IP-H456030	450 x 600 x 300	622	395 x 545	2	25
IP-H606021	600 x 600 x 210	720	545 x 545	2	26.5
IP-H508030	500 x 800 x 300	672	445 x 745	2	39.5
IP-H808030	800 x 800 x 300	972	745 x 745	2	47.5
IP-H1008030	1000 x 800 x 300	1172	945 x 745	3	57
IP-H1208030	1200 x 800 x 300	1372	1145 x 745	3	76
IP-H1806041*	1800 x 602 x 410	2023	1715 x 489	3 Point	88
IP-H1808051*	1800 x 802 x 510	2082	1715 x 689	3 Point	114



IP69K Pushbutton Enclosures

Stainless Steel Grade 304

HPB

IP66 | IP69K



The HPB range of IP69K Pushbutton Enclosures are designed for applications within the food & beverage, pharmaceutical and other industries.

Features & Specifications

IP69K pushbutton enclosures are designed to prevent contamination and are suitable for the food & beverage, pharmaceutical and other industries.

Protection: IP66 IK08, IP69K, Nema Type 1, 12, 4, 4x.

Standard: EN/AS60529, ISO20653, UL508A, RoHS Compliant



Material:

- Body: 1.0mm Grade 304 Stainless Steel
- Cover: 1.0mm Grade 304 Stainless Steel
- Seal: Blue Silicone FDA compliant

Holes: Ø 22.5

Body: The body is fabricated using 1.0mm Grade 304 Stainless Steel. It is designed to be completely smooth and without crevices and without concave angles to facilitate cleaning and avoid deposits. The body is designed to promote self draining for ease of hygienic cleaning.

Cover: The cover is fabricated using 1.0mm Grade 304 Stainless Steel and includes a clip-in silicone seal.

Seal: Blue silicone seal, FDA compliant for food production areas.

Accessories: Hygienic Wall Mounting Brackets. SKU: IP-HWMB (Set of 2)

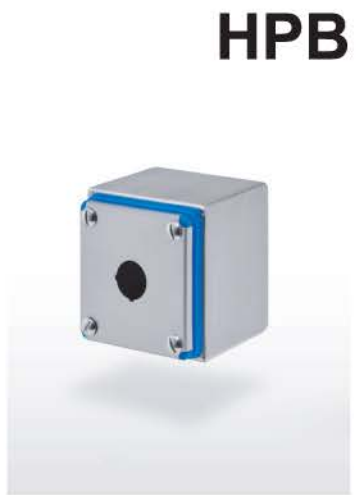

Part Number	Enclosure Size	Number of Holes	Hole Centres	Useable Depth	Mass
SKU	H x W x D (mm)	Dia.22.5mm	mm	mm	Kg
IP-HPB1	90 x 90 x 90	1	-	75	0.52
IP-HPB2	140 x 90 x 90	2	55	75	0.68
IP-HPB3	200 x 90 x 90	3	55	75	0.91
IP-HPB4	280 x 90 x 90	4	60	75	1.11



IP69K Terminal Boxes

Stainless Steel Grade 304

HTB

IP66 | IP69K



The HTB range of IP69K Terminal Boxes are designed for applications within the food & beverage, pharmaceutical and other industries.

Features & Specifications

IP69K terminal boxes are designed to prevent contamination and are suitable for the food & beverage, pharmaceutical and other industries.

Protection: IP66 IK08, IP69K, Nema Type 1, 12, 4, 4x.

Standard: EN/AS60529, ISO20653, UL508A, RoHS Compliant



Material:

- Body: 1.0 to 1.2mm Grade 304 Stainless Steel
- Cover: 1.0 to 1.2mm Grade 304 Stainless Steel
- Seal: Blue Silicone FDA compliant

Body: The body is fabricated using 1.0mm to 1.2mm Grade 304 Stainless Steel. It is designed to be completely smooth and without crevices and without concave angles to facilitate cleaning and avoid deposits. The body is designed to promote self draining for ease of hygienic cleaning.

Cover: The cover is fabricated using 1.0mm to 1.2mm Grade 304 Stainless Steel and includes a clip-in silicone seal.

Seal: FDA compliant for food production areas.

Accessories: Wall Mounting Brackets. SKU: IP-HWMB (Set of 2)

Part Number	Enclosure Size	Useable Depth	Mass
SKU	H x W x D (mm)	mm	Kg
IP-HTB1010	100 x 100 x 100	85	0.72
IP-HTB1610	160 x 100 x 100	85	1.01
IP-HTB2010	200 x 100 x 100	85	1.21
IP-HTB1616	160 x 160 x 100	85	1.43
IP-HTB2516	250 x 160 x 100	85	2.05
IP-HTB2020	200 x 200x 100	85	2.12

HTB



IP66 Pushbutton Enclosures

SSP

Stainless Steel Grade 304

FLAT ROOF | IP66 | 22.5mm Hole



Features & Specifications

The IP Enclosures SSP range of grade 304 stainless steel pushbutton enclosures are ideal for use in the harshest environments. The silicone seal gasket is resistant to harsh chemicals. They are available in 1 hole, 2 hole, 3 hole, 4 hole, 6 hole and 8 hole configurations.

Protection: IP66, NEMA 4x

Standard: UL508A Certified 

Material:

- Body: 1.0mm Grade 304 Stainless Steel
- Lid/Door: 1.0mm Grade 304 Stainless Steel
- Seal: Silicone

Body: The robust body is fabricated using 1.0mm Grade 304 Stainless Steel and incorporates a high quality Silicone seal.

Lid/Door: The robust pre-drilled lid/door is fabricated using 1.0mm Grade 304 Stainless Steel and is fastened using screws.

Seal: High quality Silicone seal.



FLAT ROOF

Part Number	Description
Standard	Number of 22.5mm Holes
IP-304-P1	1 Hole
IP-304-P2	2 Hole
IP-304-P3	3 Hole
IP-304-P4	4 Hole
IP-304-P2X2	4 Hole (2 Columns of 2)
IP-304-P3X2	6 Hole (3 Columns of 2)
IP-304-P4X2	8 Hole (4 Columns of 2)

IP66 Terminal Boxes

Stainless Steel Grade 304

SST

SCREWED LID | IP66



The IP Enclosures SST range of grade 304 stainless steel terminal boxes are designed for use in the most demanding industrial environments.

Features & Specifications

The IP Enclosures SST range of grade 304 stainless steel terminal boxes are designed for use in the most demanding industrial environments.

Protection: IP66, NEMA 4x

Standard: UL508A Certified 

Material:

- Body: 1.0mm. Grade 304 Stainless Steel
- Door: 1.0mm. Grade 304 Stainless Steel
- Seal: Silicone

Body: The robust body is fabricated using 1.0mm Grade 304 Stainless Steel and incorporates a high quality Silicone seal.

Lid/Door: The robust pre-drilled lid/door is fabricated using 1.0mm Grade 304 Stainless Steel and is fastened using screws.

Seal: High quality Silicone seal.

Internal Plate: The inner plate is fabricated using 2.5mm sheet steel, supplied pre-fitted into the terminal box as standard.



Part Number	Size
SKU	H x W x D (mm)
IP-304-T090909	90 x 90 x 90
IP-304-T140909	140 x 90 x 90
IP-304-T200909	200 x 90 x 90
IP-304-T280909	280 x 90 x 90
IP-304-T101010	100 x 100 x 100
IP-304-T161010	160 x 100 x 100
IP-304-T161610	160 x 160 x 100
IP-304-T251610	250 x 160 x 100
IP-304-T202010	200 x 200 x 100
IP-304-T402012	400 x 200 x 120
IP-304-T403012	400 x 300 x 120
IP-304-T404012	400 x 400 x 120

HMI Enclosures

Steel | Powder Coated

HMI

FRONT PANEL | REAR DOOR | IP66



The HMI Enclosure range is an aesthetic and ergonomic control panel system. The simplified flat front panel is designed to mount operator interfaces. Access is via a lockable rear door incorporating a device mounting plate. HMI Enclosures are designed for use with IP Enclosures Support Arm Systems. *(Touch Panel not included)*

Features & Specifications

The IP Enclosures range of IP66 HMI Enclosures are an aesthetic and ergonomic control panel system. The simplified flat front panel is designed to mount operator interfaces. Access is via a lockable rear door. HMI Enclosures are designed for use with IP Enclosures Support Arm Systems.

Protection: IP66

Standard: AS/EN/IEC60529, RoHS  

Material:

- Enclosure Body: 2.0mm galvanised steel sheet
- Enclosure Door: Galvanised steel sheet
- Enclosure Front Panel: Galvanised steel sheet
- Enclosure Seal: Polyurethane

Body: The robust monoblock body is fabricated using 2.0mm galvanised steel sheet. Cutting, pressing and full continuous seam welding using precision automated manufacturing equipment ensures accuracy and consistent high quality. Flat face sealing surfaces are provided to increase seal life. M6 earth studs and equipment mounting studs are provided.

Door: The robust surface mounted door is fabricated using galvanised steel sheet and incorporates concealed removable hinges with captive pins. The door is designed for a 110° opening. The door contains an integral device mounting plate and a high quality machine-applied foamed in place (FIP) Polyurethane seal.

Front Panel: The front panel is fabricated using galvanised steel sheet. It is removable via internal fasteners to cut or machine holes to mount HMI's and operator devices. Sealing is achieved via a high quality machine-applied foamed in place (FIP) Polyurethane seal.

Seals: A high quality machine-applied full perimeter UL listed Polyurethane seal foamed in place (FIP) provides excellent sealing over a long life. Temperature resistance -40°C to 80°C (160°C short term loading).

Lock: Chrome 5mm double bit insert quarter turn lock with key.

Surface Treatment: UL approved epoxy polyester powder coated with a textured finish. 80-120 micron average thickness. (RAL7035 Standard)

Steel



Part Number	Size	SKU Suffix
SKU	H x W x D (mm)	Optional Colour
IP-HMI303015	300 H x 300 W x 150 D	-BLK -OR -RED
IP-HMI304015	300 H x 400 W x 150 D	-BLK -OR -RED
IP-HMI304025	300 H x 400 W x 250 D	-BLK -OR -RED
IP-HMI354515	350 H x 450 W x 150 D	-BLK -OR -RED
IP-HMI354525	350 H x 450 W x 250 D	-BLK -OR -RED
IP-HMI406015	400 H x 600 W x 150 D	-BLK -OR -RED
IP-HMI406025	400 H x 600 W x 250 D	-BLK -OR -RED

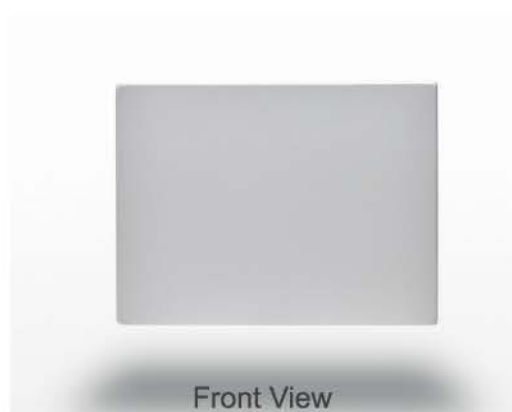

HMI Enclosures

304 Stainless Steel

SSHMI

FRONT PANEL | REAR DOOR | IP66



The stainless steel HMI Enclosure range is an aesthetic and ergonomic control panel system. The simplified flat front panel is designed to mount operator interfaces. Access is via a lockable rear door incorporating a device mounting plate.
(Touch Panel not included)

Features & Specifications

The IP Enclosures range of IP66 stainless steel HMI Enclosures are an aesthetic and ergonomic control panel system. The simplified flat front panel is designed to mount operator interfaces. Access is via a lockable rear door. HMI Enclosures are designed for use with IP Enclosures Support Arm Systems.

Protection: IP66

Standard: AS/EN/IEC60529, RoHS  

Material:

- Enclosure Body: Grade 304/304L Stainless Steel
- Enclosure Door: Grade 304/304L Stainless Steel
- Enclosure Front Panel: Grade 304/304L Stainless Steel
- Enclosure Seal: Polyurethane

Body: The robust monoblock body is fabricated using 2.0mm grade 304 stainless steel. Cutting, pressing and full continuous seam welding using precision automated manufacturing equipment ensures accuracy and consistent high quality. Flat face sealing surfaces are provided to increase seal life. M6 earth studs and equipment mounting studs are provided.

Door: The robust surface mounted door is fabricated using grade 304 stainless steel and incorporates concealed removable hinges with captive pins. The door is designed for a 110° opening. The door contains an integral device mounting plate and a high quality machine-applied foamed in place (FIP) Polyurethane seal.

Front Panel: The front panel is fabricated using grade 304 stainless steel. It is removable via internal fasteners to cut or machine holes to mount HMI's and operator devices. Sealing is achieved via a high quality machine-applied foamed in place (FIP) Polyurethane seal.

Seals: A high quality machine-applied full perimeter UL listed Polyurethane seal foamed in place (FIP) provides excellent sealing over a long life. Temperature resistance -40°C to 80°C (160°C short term loading).

Lock: Grade 316 stainless steel 8mm square bit insert quarter turn lock with key.



Part Number	Size
SKU	H x W x D (mm)
IP-304-HMI303015	300 H x 300 W x 150 D
IP-304-HMI304015	300 H x 400 W x 150 D
IP-304-HMI304025	300 H x 400 W x 250 D
IP-304-HMI354515	350 H x 450 W x 150 D
IP-304-HMI354525	350 H x 450 W x 250 D
IP-304-HMI406015	400 H x 600 W x 150 D
IP-304-HMI406025	400 H x 600 W x 250 D

Accessories

Support Arm Systems



Support arm systems enable safe operator access to HMI's and enable strategic positioning of visual display outputs.

IP Enclosures provide support arm systems for HMI enclosures designed for ease of assembly and operator accessibility. Support arms enable safe operator access to HMI's and enable strategic positioning of visual display outputs.

IP-045 – Light Duty Support Arm System

Designed for light loads and short spans. It has a modular structure and modern design. Consists of a wide range of components for various configurations. It has a carrying capacity of 40kg for a 1m profile length.



IP-060 – Medium Duty Support Arm System

Designed for medium loads and long spans. It has a modular structure and modern design. Consists of a wide range of components for various configurations. It has a carrying capacity of 60kg for a 1m profile length. It is suitable for VESA Mounting also known as VESA Mounting Interface Standard or Flat Display Mounting Interface (FDMI) for mounting monitors.



IP-120 – Heavy Duty Support Arm System

Designed for heavy loads and long spans. It has a modular structure and modern design. Consists of a wide range of components for various configurations. It has a carrying capacity of 120kg for a 1m profile length.



Note: For details on the full range of profile and fittings, contact IP Enclosures.

Thermal Control - Cooling

Air Conditioners

IP-AC

350W to 4kW | Indoor & Outdoor



IP Enclosures air conditioners are designed for the cooling needs of electrical cabinets, optimised for door or side-panel mounting and have been designed for high efficiency and low maintenance. They are made in Italy.

350W Wall Mounted Air Conditioner		INDOOR	OUTDOOR
Part Number	SKU	IP-ACIWM035.001	IP-ACOWM035
Power supply	V/Hz	230V/ 1ph/50-60	
Dimensions HxWxD	mm	430x280x170	
Cooling capacity A35A35	W	350/370	
Cooling capacity A35A50	W	200/220	
Max current	A	1.8/1.9	
Delayed fuse	A	4	
Absorbed electric power A35A35	W	260/270	
Absorbed electric power A35A50	W	280/300	

850W Wall Mounted Air Conditioner		INDOOR	OUTDOOR
Part Number	SKU	IP-ACIWM085.001	IP-ACOWM085
Power supply	V/Hz	230V/ 1ph/50-60	
Dimensions HxWxD	mm	635x305x210	
Cooling capacity A35A35	W	850/900	
Cooling capacity A35A50	W	625/650	
Max current	A	2.65/2.75	
Delayed fuse	A	6	
Absorbed electric power A35A35	W	450/470	
Absorbed electric power A35A50	W	530/560	

1450W Wall Mounted Air Conditioner		INDOOR	OUTDOOR
Part Number	SKU	IP-ACIWM145.001	IP-ACOWM145
Power supply	V/Hz	230V/ 1ph/50-60	
Dimensions HxWxD	mm	800x400x240	
Cooling capacity A35A35	W	1450/1500	
Cooling capacity A35A50	W	1150/1200	
Max current	A	3.7/4.2	
Delayed fuse	A	6	
Absorbed electric power A35A35	W	650/700	
Absorbed electric power A35A50	W	770/850	

2000W Wall Mounted Air Conditioner		INDOOR	OUTDOOR
Part Number	SKU	IP-ACIWM200.001	IP-ACOWM200
Power supply	V/Hz	230V/ 1ph/50-60	
Dimensions HxWxD	mm	1000x400x240	
Cooling capacity A35A35	W	2000/2100	
Cooling capacity A35A50	W	1200/1250	
Max current	A	6.6/6.9	
Delayed fuse	A	10	
Absorbed electric power A35A35	W	1060/1100	
Absorbed electric power A35A50	W	1240/1300	

3000W Wall Mounted Air Conditioner		INDOOR	OUTDOOR
Part Number	SKU	IP-ACIWM300.001	IP-ACOWM300
Power supply	V/Hz	400V/3ph/50 - 460V/3ph/60	
Dimensions HxWxD	mm	1500x400x255	
Cooling capacity A35A35	W	2800/2950	
Cooling capacity A35A50	W	2150/2330	
Max current	A	2.2/2.6	
Delayed fuse	A	16	
Absorbed electric power A35A35	W	2090/2200	
Absorbed electric power A35A50	W	2400/2550	

4000W Wall Mounted Air Conditioner		INDOOR	OUTDOOR
Part Number	SKU	IP-ACIWM400.001	IP-ACOWM400
Power supply	V/Hz	400V/3ph/50 - 460V/3ph/60	
Dimensions HxWxD	mm	1500x400x255	
Cooling capacity A35A35	W	3800/3980	
Cooling capacity A35A50	W	2800/3160	
Max current	A	2.7/3.0	
Delayed fuse	A	16	
Absorbed electric power A35A35	W	2200/2320	
Absorbed electric power A35A50	W	2600/2750	

Note: Roof mounted air conditioners are also available upon request.

Thermal Control - Cooling

IP-AC

Stainless Steel Grade 304 | Air Conditioners

350W to 4kW | Outdoor



IP Enclosures stainless steel air conditioners are designed for the cooling needs of electrical cabinets, optimised for door or side-panel mounting and have been designed for high efficiency and low maintenance. They are made in Italy.

350W Wall Mounted Air Conditioner		OUTDOOR
Part Number	SKU	IP-ACOWM035.OX
Power supply	V/Hz	230V/ 1ph/ 50-60
Dimensions HxWxD	mm	430x280x170
Cooling capacity A35A35	W	350/370
Cooling capacity A35A50	W	200/220
Max current	A	1.8/1.9
Delayed fuse	A	4
Absorbed electric power A35A35	W	260/270
Absorbed electric power A35A50	W	280/300
850W Wall Mounted Air Conditioner		OUTDOOR
Part Number	SKU	IP-ACOWM085.OX
Power supply	V/Hz	230V/ 1ph/ 50-60
Dimensions HxWxD	mm	635x305x210
Cooling capacity A35A35	W	850/900
Cooling capacity A35A50	W	625/650
Max current	A	2.65/2.75
Delayed fuse	A	6
Absorbed electric power A35A35	W	450/470
Absorbed electric power A35A50	W	530/560
1450W Wall Mounted Air Conditioner		OUTDOOR
Part Number	SKU	IP-ACOWM145.OX
Power supply	V/Hz	230V/ 1ph/ 50-60
Dimensions HxWxD	mm	800x400x240
Cooling capacity A35A35	W	1450/ 1500
Cooling capacity A35A50	W	1150/ 1200
Max current	A	3.7/ 4.2
Delayed fuse	A	6
Absorbed electric power A35A35	W	650/ 700
Absorbed electric power A35A50	W	770/ 850
2000W Wall Mounted Air Conditioner		OUTDOOR
Part Number	SKU	IP-ACOWM200.OX
Power supply	V/Hz	230V/ 1ph/ 50-60
Dimensions HxWxD	mm	1000x400x240
Cooling capacity A35A35	W	2000/ 2100
Cooling capacity A35A50	W	1200/ 1250
Max current	A	6.6/ 6.9
Delayed fuse	A	10
Absorbed electric power A35A35	W	1060/ 1100
Absorbed electric power A35A50	W	1240/ 1300
3000W Wall Mounted Air Conditioner		OUTDOOR
Part Number	SKU	IP-ACOWM300.OX
Power supply	V/Hz	400V/ 3ph/ 50 - 460V/ 3ph/ 60
Dimensions HxWxD	mm	1500x400x255
Cooling capacity A35A35	W	2800/ 2950
Cooling capacity A35A50	W	2150/ 2330
Max current	A	2.2/ 2.6
Delayed fuse	A	16
Absorbed electric power A35A35	W	2090/ 2200
Absorbed electric power A35A50	W	2400/ 2550
4000W Wall Mounted Air Conditioner		OUTDOOR
Part Number	SKU	IP-ACOWM400.OX
Power supply	V/Hz	400V/ 3ph/ 50 - 460V/ 3ph/ 60
Dimensions HxWxD	mm	1500x400x255
Cooling capacity A35A35	W	3800/ 3980
Cooling capacity A35A50	W	2800/ 3160
Max current	A	2.7/ 3.0
Delayed fuse	A	16
Absorbed electric power A35A35	W	2200/ 2320
Absorbed electric power A35A50	W	2600/ 2750

Note: Roof mounted air conditioners are also available upon request.

Thermal Control - Ventilation

IP-V

Filter Vents & Fans

12VDC to 230VAC | 26m³/h to 700m³/h | IP54 (IP55 Optional)



IP Enclosures range of filter fans and vents feature a modern Italian grille design with minimal external projection. The front-opening grille allows filters to be easily maintained from the outside of the enclosure.

Features & Specifications

IP Enclosures provide a wide range of ventilation products for electrical enclosures. The front-opening grille allows filters to be easily maintained from the outside of the enclosure. All molded parts are made of highly resistant and self-extinguishing ABS. IP Enclosures ventilation products are manufactured to the highest quality in Italy.

Protection: IP54 (or IP55 if used with High Efficiency Filter Mat IP-VFXX or Vent Hood)

Conformity:  

Material: ABS UL94V-0 color RAL7035 (Optional Colour Black)

Flow Direction: Reversible

FEATURES

Modern Design: A positive visual impact is provided by the modern grille design and minimal external projection. All molded parts are made of highly resistant and self-extinguishing ABS, UL94 VO grade. The standard color is RAL7035.

Easy Maintenance: Filter mats can be easily maintained from outside of the enclosure due to the front-opening grille. Replacement of soiled filter mats takes only a few seconds without the use of tools.

Wide Range of Air Flow Ratings: 26m³/h to 700m³/h

Optimal Enclosure Protection: The special configuration of the grille, foam seal gasket and filter mat ensures an IP54 protection of the enclosure.

Quick Electrical Connection: Fitted with spring terminals for faster and safer wiring. Default terminal position is above the fan but can be easily changed to bottom of fan to suit wiring needs without tools.

Reversible Fan: Default air flow direction is from outside to inside of the enclosure. If required, air flow can be reversed due to quick release fan lock system without the use of tools.

Fast Installation: Installation is fast due to the simple square cutout on the enclosure and the snap-in fixing system. No fasteners are required.

Vent Hoods: To obtain IP55 protection, use in conjunction with IP Enclosures vent hoods. Hinged vent hoods are available to provide operator access to easily maintain filters from the outside of the enclosure.



Easy Maintenance due to Front Opening Grille



Step 1: Open Grille



Step 2: Remove Filter



Step 3: Insert Filter



Step 4: Close Grille

114mm x 114mm 26m3/hr		Vent	230V Fan	115V Fan	12VDC Fan	24VDC Fan
Part Number	SKU	IP-V1000	IP-V1100	IP-V1101	IP-V1112	IP-V1124
Air flow rate (free blow)	m3/h	-	26 (30)		26	
Air flow rate with exit filter	m3/h	-	15 (18)		15	
Power supply	V/Hz	-	230 / 50-60	115 / 50-60	12DC	24DC
Dimensions HxWxD	mm	114x114x27	114x114x73		114x114x60	
Power consumption	W	-	13 (12)		3	4
Current consumption	A	-	0.10 (0.08)	0.14 (0.12)	0.25	0.16
Overcurrent protection	-	-	impedance			
Electrical connection	-	-	3-poles spring terminals*		2-poles spring terminals*	
Duty cycle	-	-	100%			
Operating temperature	°C (°F)	-10 / +70 (+14/+158)				
Protection degree / Class	-	IP54	IP54 / Class I			
Noise level	dB(A)	-	30 (35)		35	
Flow direction	-	-	reversible, default factory setting outside-in			
Bearing	-	-	ball			
Filter mat EN779	-	G2	G2			
Cut-out Dimensions	mm	92x92	92x92			
Material	-	ABS UL94V-0 color RAL7035				

150mm x 150mm 58m3/hr		Vent	230V Fan	115V Fan	24VDC Fan	48VDC Fan
Part Number	SKU	IP-V2000*	IP-V2200*	IP-V2201	IP-V2224	IP-V2248
Air Flow rate (free blow)	m3/h	-	58(64)		58	
Air flow rate with exit filter	m3/h	-	43(48)		43	
Power supply	V/Hz	-	230 / 50-60	115 / 50-60	24DC	48DC
Dimensions HxWxD	mm	150x150x37	150x150x86			
Power consumption	W	-	22 (21)		9	13
Current consumption	A	-	0.14 (0.12)	0.26 (0.24)	0.37	0.27
Overcurrent protection	-	-	impedance			
Electrical connection	-	-	3-poles spring terminals*		2-poles spring terminals*	
Duty cycle	-	-	100%			
Operating temperature	°C (°F)	-10 / +70 (+14/+158)				
Protection degree / Class	-	IP54	IP54 / Class I			
Noise level	dB(A)	-	43(49)		45	
Flow direction	-	-	reversible, default factory setting outside-in			
Bearing	-	-	ball			
Filter mat EN779	-	G3	G3			
Cut-out Dimensions	mm	124x124	124x124			
Material	-	ABS UL94V-0 color RAL7035*				

*Available in Black IP-V2000-BLK; IP-V2200-BLK

204mm x 204mm 115m3/hr		Vent	230V Fan	115V Fan	24VDC Fan	48VDC Fan
Part Number	SKU	IP-V3000	IP-V3200	IP-V3201	IP-V3224	IP-V3248
Air flow rate (free blow)	m3/h	-	115 (125)		115	
Air flow rate with exit filter	m3/h	-	84 (97)		84	
Power supply	V/Hz	-	230 / 50-60	115 / 50-60	24DC	48DC
Dimensions HxWxD	mm	204x204x37	204x204x104			
Power consumption	W	-	22 (21)		9	13
Current consumption	A	-	0.14 (0.12)	0.26 (0.24)	0.37	0.27
Overcurrent protection	-	-	impedance			
Electrical connection	-	-	3-poles spring terminals*		2-poles spring terminals*	
Duty cycle	-	-	100%			
Operating temperature	°C (°F)	-10 / +70 (+14/+158)				
Protection degree / Class	-	IP54	IP54 / Class I			
Noise level	dB(A)	-	43 (49)		45	
Flow direction	-	-	reversible, default factory setting outside-in			
Bearing	-	-	ball			
Filter mat EN779	-	G3	G3			
Cut-out Dimensions	mm	177x177	177x177			
Material	-	ABS UL94V-0 color RAL7035				

Note: Filter Vents and Fans are also available in Black colour upon request.

250mm x 250mm 125m3/hr		Vent	230V Fan	115V Fan	24VDC Fan	48VDC Fan
Part Number	SKU	IP-V4000	IP-V4200	IP-V4201	IP-V4224	IP-V4248
Air flow rate (free blow)	m3/h	-	125 (135)		125	
Air flow rate with exit filter	m3/h	-	102 (112)		102	
Power supply	V/Hz	-	230 / 50-60	115 / 50-60	24DC	48DC
Dimensions HxWxD	mm	250x250x38	250x250x107			
Power consumption	W	-	22 (21)		9	13
Current consumption	A	-	0.14 (0.12)	0.26 (0.24)	0.37	0.27
Overcurrent protection	-	-	impedance			
Electrical connection	-	-	3-poles spring terminals*		2-poles spring terminals*	
Duty cycle	-	-	100%			
Operating temperature	°C (°F)	-10 / +70 (+14/+158)				
Protection degree / Class	-	IP54	IP54 / Class I			
Noise level	dB(A)	-	43 (49)		45	
Flow direction	-	-	reversible, default factory setting outside-in			
Bearing	-	-	ball			
Filter mat EN779	-	G3	G3			
Cut-out Dimensions	mm	224x224	224x224			
Material	-	ABS UL94V-0 color RAL7035				

250mm x 250mm 255m3/hr to 410m3/hr		230V	115V	24VDC	48VDC	230V	115V	400V	
Part Number	SKU	IP-V4000	IP-V4300	IP-V4301	IP-V4324	IP-V4348	IP-V4400	IP-V4401	IP-V4440
Air flow rate (free blow)	m3/h	-	255 (290)		255		410 (445)		
Air flow rate with exit filter	m3/h	-	202 (235)		202		280 (302)		
Power supply	V/Hz	-	230 / 50-60	115 / 50-60	24DC	48DC	230 / 50-60	115 / 50-60	400 / 50-60
Dimensions HxWxD	mm	250x250x38	250x250x128				250x250x136		
Power consumption	W	-	40 (38)		26	33	70 (90)		60 (70)
Current consumption	A	-	0.17 (0.16)	0.34 (0.32)	1.08	0.68	0.40 (0.38)	0.80 (0.76)	0.18 (0.15)
Overcurrent protection	-	-	thermal		impedance		thermal		
Electrical connection	-	-	3-poles spring terminals*		2-poles spring terminals*		3-poles spring terminals*		4-p s t*
Duty cycle	-	-	100%						
Operating temperature	°C (°F)	-10 / +70 (+14/+158)							
Protection degree / Class	-	IP54	IP54 / Class I						
Noise level	dB(A)	-	53 (58)		61		65 (68)		
Flow direction	-	-	reversible, default factory setting outside-in						
Bearing	-	-	ball						
Filter mat EN779	-	G3	G3						
Cut-out Dimensions	mm	224x224	224x224						
Material	-	ABS UL94V-0 color RAL7035							

325mm x 325mm 550m3/hr - 700m3/hr		230V Fan	115V Fan	400V Fan	230V Fan	115V Fan		
Part Number	SKU	IP-V5000	IP-V5400	IP-V5401	IP-V5440	IP-V5500	IP-V5501	
Air flow rate (free blow)	m3/h	-	550 (620)			700 (770)		
Air flow rate with exit filter	m3/h	-	405 (450)			520 (575)		
Power supply	V/Hz	-	230 / 50-60	115 / 50-60	400 / 50-60	230 / 50-60	115 / 50-60	
Dimensions HxWxD	mm	325x325x42	325x325x140			325x325x154		
Power consumption	W	-	70 (90)		60 (70)	130 (180)		
Current consumption	A	-	0.40 (0.38)	0.80 (0.76)	0.18 (0.15)	0.55 (0.81)	1.10 (1.62)	
Overcurrent protection	-	-	thermal				3-poles spring terminals*	
Electrical connection	-	-	3-poles spring terminals*		4-p s t*	3-poles spring terminals*		
Duty cycle	-	-	100%					
Operating temperature	°C (°F)	-10 / +70 (+14/+158)						
Protection degree / Class	-	IP54	IP54 / Class I					
Noise level	dB(A)	-	65 (68)			72 (73)		
Flow direction	-	-	reversible, default factory setting outside-in					
Bearing	-	-	ball					
Filter mat EN779	-	G3	G3					
Cut-out Dimensions	mm	291x291	291x291					
Material	-	ABS UL94V-0 color RAL7035						

Note: Filter Vents and Fans are also available in Black colour upon request.

Thermal Control - Ventilation

IP-RV/RFV

Roof Vents & Roof Fans

230VAC | 600m³/h to 1500m³/h | IP44, IP54



IP Enclosures provide a wide range of roof mounted ventilation products for electrical cabinets.

Features & Specifications

IP-RV/RFV

IP Enclosures provide a wide range of ventilation products for electrical enclosures. All molded parts are made of highly resistant and self-extinguishing ABS. IP Enclosures ventilation products are manufactured to the highest quality in Italy.

Protection: IP44, IP54

Conformity:  

Material: ABS UL94V-0 color RAL7035 | Steel Color RAL7035

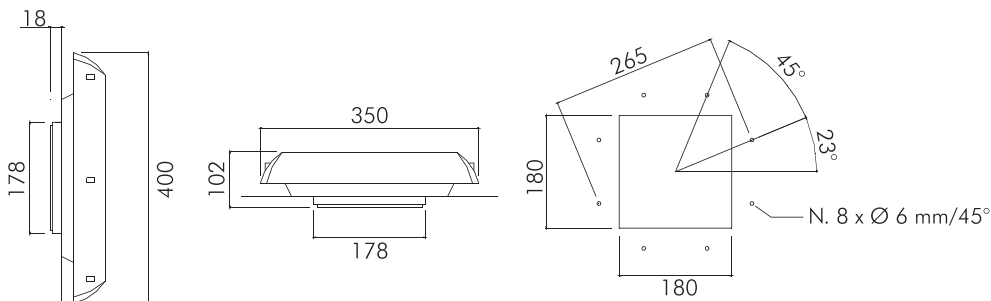

		Roof Vent	600m3 Fan	860m3 Fan	1000m3 Fan	Roof Vent	1500m3 Fan
		IP-RV1	IP-RFV1	IP-RFV2	IP-RFV3	IP-RV4	IP-RFV4
Features	Unit						
Air flow rate (free blow)	m³/h	-	600/(625)	860/(950)	1000/(1050)	-	1500/(1550)
Flow rate with filter fan	m³/h	-	430/(450)	580/(640)	700/(720)	-	900/(950)
Power supply	V/Hz	-	230-50/60	230-50/60	230-50/60	-	230-50/60
Dimensions HxWxD	mm	400x350x102				540x390x150	540x390x128
Power consumption	W	-	70/(90)	85/(115)	120/(170)	-	160/(215)
Current consumption	A	-	0.32/(0.40)	0.43/(0.50)	0.50/(0.75)	-	0.70/(0.98)
Overcurrent protection	-	-	thermal			-	thermal
Electric connection	-	-	4-pole terminal 2.5 mm²			-	4-pole terminal 2.5 mm²
Duty cycle	-	-	100%			-	100%
Operating temperature	°C(°F)	-10/+70 (+14/+158)				-20/+50 (-4/+22)	-10/+70 (+14/+158)
Protection degree enclosure side	-	IP44				IP54	IP44
Protection class	-	-	Class I			-	Class I
Noise level	dB(A)	-	64(65)	72(73)	72(73)	-	74(75)
Flow direction	-	-	inside-out			-	inside-out
Bearing	-	-	ball			-	ball
Service life (at 40°C)	hr	-	50.000			-	50.000
Material	-	ABS UL94V-0 Color RAL7035				Steel Color RAL7035	
Gasket	-	Self-Adhesive				PVC	
Weight (with packaging)	kg	2.30(2.50)	3.65(3.85)	4.00(4.20)	4.75(4.95)	5.2(5.5)	11.3(12.3)
Package dimensions	mm	410x360x130				550x400x140	
Mounting	-	Screws					
Conformity/ Certifications	-	CE					

Accessories

Louvre Vents, Vent Hoods & Sun Shields



IP Enclosures vent hoods assist to protect internal components by increasing the protection of fans and vents up to IP56. Hinged vent hoods are also available to enable easy access to fans and filters for filter maintenance without the need to open the enclosure.

Louvre Vents

STEEL



STAINLESS STEEL

Part Number	Size	Part Number Suffix			Part Number	Size
Standard	H x W (mm)	Optional Colours			Standard	H x W (mm)
IP-PSLV10075	100 x 75	-BLK	-OR	-RED	IP-SSLV10075	100 x 75
IP-PSLV130130	130 x 130	-BLK	-OR	-RED	IP-SSLV130130	130 x 130



Vent Hoods (Standard)

STEEL



STAINLESS STEEL

Part Number	Size	To Suit Fan/Vent	Part Number Suffix			Part Number	Size	To Suit Fan/Vent	
Standard	H x W x D (mm)	Size	Optional Colours			Standard	H x W x D (mm)	Size	
IP-PSVH2517	250 x 175 x 50	IP-V1XXX	-T33	-BLK	-OR	-RED	IP-SSVH2517	250 x 175 x 50	IP-V1XXX
IP-PSVH3020	300 x 200 x 50	IP-V1XXX	-T33	-BLK	-OR	-RED	IP-SSVH3020	300 x 200 x 50	IP-V1XXX
*IP-PSVH3222	320 x 220 x 50	Up to IP-V2XXX	-T33	-BLK	-OR	-RED	*IP-SSVH3222	320 x 220 x 50	Up to IP-V2XXX
IP-PSVH4030	400 x 300 x 50	Up to IP-V3XXX	-T33	-BLK	-OR	-RED	IP-SSVH4030	400 x 300 x 50	Up to IP-V3XXX
IP-PSVH4737	475 x 375 x 75	Up to IP-V4XXX	-T33	-BLK	-OR	-RED	IP-SSVH4737	475 x 375 x 75	Up to IP-V4XXX
IP-PSVH5040	500 x 400 x 75	Up to IP-V5XXX	-T33	-BLK	-OR	-RED	IP-SSVH5040	500 x 400 x 75	Up to IP-V5XXX

IP Rating: IP55. Item marked with "*" is IP56. (When used with IP Enclosures fans & filters)



Hinged Vent Hoods (For use with filter fans/vents)

STEEL



STAINLESS STEEL

Part Number	Dimensions	To Suit Fan/Vent	Part Number Suffix			Part Number	Size	To Suit Fan/Vent	
Standard	H x W x D (mm)	Size	Optional Colours			Standard	H x W x D (mm)	Size	
IP-PSVH2517-H	250 x 175 x 50	IP-V1XXX	-T33	-BLK	-OR	-RED	IP-SSVH2517-H	250 x 175 x 50	IP-V1XXX
IP-PSVH3020-H	300 x 200 x 50	IP-V1XXX	-T33	-BLK	-OR	-RED	IP-SSVH3020-H	300 x 200 x 50	IP-V1XXX
IP-PSVH3224-H	320 x 220 x 50	Up to IP-V2XXX	-T33	-BLK	-OR	-RED	IP-SSVH3224-H	320 x 220 x 50	Up to IP-V2XXX
IP-PSVH4030-H	400 x 300 x 50	Up to IP-V3XXX	-T33	-BLK	-OR	-RED	IP-SSVH4030-H	400 x 300 x 50	Up to IP-V3XXX
IP-PSVH4737-H	475 x 375 x 75	Up to IP-V4XXX	-T33	-BLK	-OR	-RED	IP-SSVH4737-H	475 x 375 x 75	Up to IP-V4XXX
IP-PSVH5040-H	500 x 400 x 75	Up to IP-V5XXX	-T33	-BLK	-OR	-RED	IP-SSVH5040-H	500 x 400 x 75	Up to IP-V5XXX



Sun Shields

STEEL



STAINLESS STEEL

Part Number	Size	Part Number Suffix			Part Number	Size
Standard	H x W x D (mm)	Optional Colours			Standard	H x W x D (mm)
IP-SUN504020	500 x 400 x 200	-BLK	-OR	-RED	IP-SUNSS504020	500 x 400 x 200
IP-SUN606030	600 x 600 x 300	-BLK	-OR	-RED	IP-SUNSS606030	600 x 600 x 300
IP-SUN806030	800 x 600 x 300	-BLK	-OR	-RED	IP-SUNSS806030	800 x 600 x 300



Ventilated Roofs

STEEL



ALUMINIUM



Part Number	Part Number	Size
Standard	Standard	W x D (mm)
IP-VR6040	IP-AVR6040	600 x 400
IP-VR8040	IP-AVR8040	800 x 400
IP-VR10040	IP-AVR10040	1000 X 400



Thermal Control - Heating

Anti-Condensation Heaters

IP-H

Compact, Touch Shield & Fan-Assisted | 50W to 750W



Anti-condensation heaters are required to prevent failures or corrosion caused by low temperatures or high humidity. IP Enclosures heating products are manufactured to the highest quality in Italy.

Anti-Condensation Heaters for Electrical Enclosures

IP-H

IP Enclosures provide a range of heating products for electrical enclosures. Our range of heating products are manufactured to the highest quality in Italy.

Compact | 50W to 150W

FEATURES	UNIT	IP-H25	IP-H50	IP-H75	IP-H100	IP-H150
Heating Capacity*	W	25	50	75	100	150
Power supply	V	120-240V AC or DC				
24V Voltage Availability	V	IP-H50.24		IP-H100.24		
48V Voltage Availability	V	IP-H100.48				
Inrush current	A	2.5	3.5	4	5	9.5
Delayed fuse (advised)	A	4	4	6.3	8	10
Electrical connections	-	2 screw terminals for stranded or rigid wire 2.5 mm ²				
Protection Class	-	Class II				
Protection degree EN60529	-	IP20				
Operating temperature	°C (°F)	-45/+70 (-49/+158)				
Storage temperature	°C (°F)	-45/+80 (-49/+176)				
Dimensions HxWxD	mm	128x59x61	100x40x40	140x59x61		220x59x61
Weight (with packaging)	kg	0.24 (0.28)		0.34 (0.38)		0.57 (0.62)
Conformity/Certifications	-	CE - UL 				
VERSIONS						
with integrated fixed thermostat NC 5°C		IP-H25.001	IP-H50.001	IP-H75.001	IP-H100.001	IP-H150 .001



Touch Shield | 25W to 150W

FEATURES	UNIT	IP-TSH25	IP-TSH50	IP-TSH75	IP-TSH100	IP-TSH150
Heating Capacity	W	25	50	75	100	150
Power supply	V	120-240V AC or DC				
Inrush current	A	2.5	3.5	4	5	9.5
Delayed fuse (advised)	A	4	4	6.3	8	10
Electrical connections	-	2 screw terminals for stranded or rigid wire 2.5 mm ²				
Protection class	-	Class II				
Protection degree EN60529	-	IP20				
Operating temperature	°C (°F)	-45/+70 (-49/+158)				
Storage temperature	°C (°F)	-45/+80 (-49/+176)				
Dimensions HxWxD	mm	125x41x41		140x63x70		220x63x70
Weight (with packaging)	kg	0.16 (0.19)		0.42 (0.46)		0.66 (0.72)
Conformity/Certifications	-	CE-UL 				
VERSIONS						
with integrated fixed thermostat NC 5°C		IP-TSH25.001	IP-TSH50.001	IP-TSH75.001	IP-TSH100.001	IP-TSH150.001



Fan Assisted | 250W to 750W

FEATURES	UNIT	IP-FH250	IP-FH251	IP-FH400	IP-FH401	IP-FH500	IP-FH501	IP-FH750	IP-FH751	
Heating Capacity	W	250	250	400	400	500	500	750	750	
Power Supply	V/Hz	230/50-60	115/50-60	230/50-60	115/50-60	230/50-60	115/50-60	230/50-60	115/50-60	
Max. current	A	1.2	2.4	1.9	3.8	2.4	4.8	3.6	7.2	
Electrical connections	-	3 screw terminals for stranded or rigid wire 2.5 mm ²								
Protection class	-	Class I, earthed								
Protection degree EN60529	-	IP20								
Operating temperature	°C (°F)	-25/+70 (-13/+158)								
Storage temperature	°C (°F)	-45/+80 (-49/+176)								
Air flow rate	m ³ /h	35 (free flow)						44 (free flow)		
Signalling	-	Green LED power ON								
Dimensions HxWxD	mm	135x112x82	135x112x82	165x112x82	165x112x82	165x112x82	165x112x82	225x112x82	225x112x82	
Weight (with packaging)	kg	0.88(0.94)	0.88(0.94)	0.97(1.04)	0.97(1.04)	0.97(1.04)	0.97(1.04)	1.35(1.42)	1.35(1.42)	
Conformity/Certifications	-	CE-UL 								



Fan Assisted (Small Footprint) | 150W to 400W

FEATURES	UNIT	IP-TMX150	IP-TMX250	IP-TMX300	IP-TMX400
Heating Capacity	W	150	250	300	400
Power Supply	V/Hz	230/50-60			
Max. current	A	-	-	-	-
Delayed fuse (advised)	A	6.3	6.3	6.3	6.3
Electrical connections	-	Spring terminals			
Protection class	-	Class II			
Protection degree EN60529	-	IP20			
Operating temperature	°C (°F)	-40/+70 (-40/+158)			
Storage temperature	°C (°F)	-40/+70 (-40/+158)			
Air flow rate	m ³ /h	30 (free flow)			
Signalling	-	-			
Dimensions HxWxD	mm	88x66x97			
Weight (with packaging)	kg	0.35			
Conformity/Certifications	-	CE-UL			



Thermal Control - Controllers

Thermostats, Hygrostat & Fan Speed Controller

IP Enclosures thermal control products are manufactured to the highest quality in Italy and are suitable for use with IP Enclosures range of heating and cooling products.

Single Thermostats | NC/NO

Features	Unit	IP-THNC1	IP-THNC2	IP-THNC3	IP-THNO1	IP-THNO2	IP-THNO3
Contact function	-	NC	NC	NC	NO	NO	NO
Temperature setting range	°C	-10/+50	0/+60	+20/+80	-10/+50	0/+60	+20/+80
Precision	°C	±4					
Hysteresis	°C	7					
Max switching current							
250Vac resistive load (inductive load)	A	10 (1.6)					
125Vac resistive load (inductive load)	A	15 (2.5)					
Max. switching power in Vdc	W	30					
Temperature sensor type	-	Thermostatic bimetal					
Contact type	-	Snap action					
Contact resistance	mOhm	< 10					
Service life	cycles	> 100 000					
Electrical connections	-	2-pole terminal for 2.5 mm ² wire					
Casing	-	PA6, UL94 V0 self-extinguishing, light grey RAL 7035					
Protection degree EN60529	-	IP20					
Operating temperature	°C (°F)	-25/+80 (-13/+176)					
Storage temperature	°C (°F)	-45/+80 (-49/+176)					
Mounting	-	Clip for mounting on DIN rail 35 mm EN50022					
Installation position	-	Variable					
Conformity/Certifications	-	CE-UL [®]  us					
Dimensions HxWxD	mm	61x34x35					



Double Thermostats | NC/NO

Features	Unit	IP-THD1		IP-THD2		IP-THD3	
Contact function	-	NC	NO	NC	NO	NO	NO
Temperature setting range	°C	-10/+50	+20/+80	0/+60	0/+60	0/+60	0/+60
Precision	°C	±4					
Hysteresis	°C	7					
Max switching current							
250Vac resistive load (inductive load)	A	10 (1.6)					
125Vac resistive load (inductive load)	A	15 (2.5)					
Max. switching power in Vdc	W	30					
Temperature sensor type	-	Thermostatic bimetal					
Contact type	-	Snap action					
Contact resistance	mOhm	< 10					
Service life	cycles	> 100 000					
Electrical connections	-	2-pole terminal for 2.5 mm ² wire					
Casing	-	PA6, UL94 V0 self-extinguishing, light grey RAL 7035					
Protection degree EN60529	-	IP20					
Operating temperature	°C (°F)	-25/+80 (-13/+176)					
Storage temperature	°C (°F)	-45/+80 (-49/+176)					
Mounting	-	Clip for mounting on DIN rail 35 mm EN50022					
Installation position	-	Variable					
Conformity/Certifications	-	CE-UL [®]  us File n. E348803					
Dimensions HxWxD	mm	61x53x35					



Mechanical Hygrostat

Features	Unit	IP-MH1
Relative Humidity setting range	RH%	20-90
Relative Humidity Hysteresis	RH%	5 (max 10)
Precision	RH%	±4
Operating temperature	°C (°F)	-10/+50 (+14/+122)

Fan Speed Controller (Image not shown)

Features	Unit	
Power supply	V/Hz	100-230/50-60
Temperature setting range	°C	+20 / +60
Fan speed setting range	%	0 - 100
Speed controller	-	partialization of wave
Input	-	NTC sensor
Max. output fan	-	300 W (100-230/50-60Hz)
Electrical connection	-	terminal for 2.5 mm ² wire
Optical signal	-	LED
Casing	-	PA6, UL94 V0 self-extinguishing, light grey RAL 7035
Protection degree EN60529	-	IP20



Accessories

LED Surface Mounted Luminaires

24V DC

IP Enclosures provide high quality LED Surface Mounted Luminaires for electrical enclosures.

Features:

- Very bright LED luminaire
- 24V DC
- Homogenous, uniform, & flicker-free illumination
- Slim, almost non-protruding LED luminaire; 25 mm high
- Clear cover; polycarbonate-material; shatterproof
- Available in clear cover glare suppression
- Quick installation (single solution/electrically interlinkable; cascadable)
- Robust aluminium housing for heat dissipation
- Made in Germany

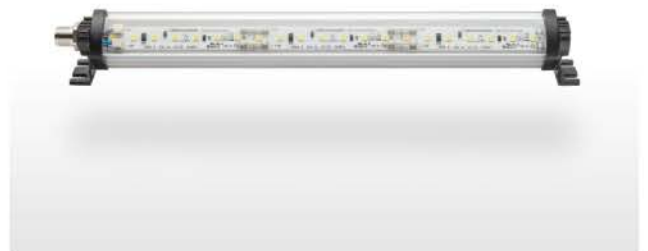

Features	Unit	IP-LED01-24VDC	IP-LED02-24VDC	IP-LED03-24VDC	IP-LED04-24VDC	IP-LED05-24VDC	IP-LED06-24VDC
Power Supply	V	24V DC					
Luminosity	Lm	145 Lm/W					
Lamp luminous flux	Lm	630 Lm	945 Lm	1260 Lm	1890 Lm	2835 Lm	3780 Lm
Lamp type	-	LED Surface-mounted Luminaire					
Illuminant	-	SMD LED					
Light distribution	-	Direct					
Light colour	-	Daylight white (5200-5700K)					
Beam angle (optics)	-	120°					
Colour rendering	Ra	>85					
Power consumption	W	~4 W	~6 W	~8 W	~13 W	~19 W	~24 W
Service life	hr	>60,000 h					
Electrical connection	-	M12 A-type encoded					
Housing material	-	Aluminium					
Cover material	-	Polycarbonate; clear; shatterproof					
Protection degree/Class	-	IP54 / Class III					
Operating temperature	°C (°F)	-10...+60 °C					
Mounting	-	Swivel / Planar mounting					
Installation	-	Electrical Interlinked					
Dimensions	mm	180(L) x 26(W) x 31(H)	260(L) x 26(W) x 31(H)	350(L) x 26(W) x 31(H)	520(L) x 26(W) x 31(H)	760(L) x 26(W) x 31(H)	1020(L) x 26(W) x 31(H)
Net weight	kg	0.18	0.20	0.30	0.35	0.50	0.70
Gross weight	kg	0.33	0.35	0.45	0.60	0.80	1.00
Conformity/Certifications	-	CE; ETL Listed					

Accessories

Locks and Swing Handles

Our electrical enclosures are supplied fitted with standard locks. However, to provide maximum flexibility, IP Enclosures also provide a full range of electrical enclosure locks, handles and high security access control solutions.



Quarter Turn

IP-L001 - 5mm Double Bit Chrome
IP-L002 - 8mm Square Chrome
IP-L026 - 5mm Double Bit Stainless Steel
IP-L027 - 8mm Square 316 Stainless Steel



Compression

IP-L058 - 316 Stainless Steel



IP69K Hygiene

IP-L030 - 316 Stainless Steel



IP69K Hygiene Compression

IP-L059 - 316 Stainless Steel



Keys

IP-L004 - 5mm Double Bit Chrome
IP-L005 - 8mm Square Chrome



Wing Knob

IP-L060 - Cast Alloy Coated Black
IP-L029 - 316 Stainless Steel



Wing Knob Keyed (Keyed Alike)

IP-L045 - Cast Alloy Coated Black
IP-L028 - 316 Stainless Steel



Wing Knob Padlockable

IP-L043 - Cast Alloy Coated Black
IP-L031 - 316 Stainless Steel



T Handle

IP-L044 - Cast Alloy Chrome
IP-L061 - Cast Alloy Coated Black
IP-L052 - 316 Stainless Steel



T Handle Keyed (Keyed Alike)

IP-L048 - Cast Alloy Chrome
IP-L049 - Cast Alloy Coated Black
IP-L053 - 316 Stainless Steel



L Handle

IP-L054 - Cast Alloy Chrome
IP-L055 - Cast Alloy Coated Black
IP-L056 - 316 Stainless Steel



L Handle Keyed (Keyed Alike)

IP-L057 - Cast Alloy Chrome
IP-L062 - Cast Alloy Coated Black
IP-L063 - 316 Stainless Steel



3 Point Wing Knob Keyed
IP-L069 - Cast Alloy Coated Black



3 Point T Handle Keyed
IP-L070 - Cast Alloy Coated Black



3 Point L Handle
IP-L071 - Cast Alloy Coated Black



BiLock Key Systems
We can accommodate customer requirements



Swing Handle
IP-L006 - Polyamide Coated Black
IP-L007 - Polyamide & Cast Alloy Coated Black



Swing Handle Padlockable
IP-L009 - Polyamide & Cast Alloy Coated Black



3 Point Swing Handle*
IP-L011 - Polyamide Coated Black
IP-L012 - Polyamide & Cast Alloy Coated Black
IP-L036 - with 5mm Double Bit Barrel



3 Point Swing Handle Padlockable*
IP-L014 - Polyamide & Cast Alloy Coated Black

Half Euro
(Suitable for fitting Bilock high security restricted key half euro systems)



Swing Handle
IP-L073 - Cast Alloy Coated Black



Swing Handle Padlockable
IP-L074 - Cast Alloy Coated Black



3 Point Swing Handle*
IP-L075 - Cast Alloy Coated Black



3 Point Swing Handle Padlockable*
IP-L076 - Cast Alloy Coated Black



Low Profile
IP-L018 - Cast Alloy Coated Black
IP-L019 - Cast Alloy Chrome



Low Profile Padlockable
IP-L041 - Cast Alloy Coated Black
IP-L042 - Cast Alloy Chrome



3 Point Low Profile*
IP-L022 - Cast Alloy Coated Black
IP-L023 - Cast Alloy Chrome



3 Point Low Profile Padlockable*
IP-L024 - Cast Alloy Coated Black
IP-L025 - Cast Alloy Chrome

Half Euro
(Suitable for fitting Bilock high security restricted key half euro systems)



Stainless Steel Swing Handle
IP-L033 - 316 Stainless Steel



Stainless Steel Swing Handle Padlockable
IP-L037 - 316 Stainless Steel



3 Point Stainless Steel Swing Handle*
IP-L035 - 316 Stainless Steel



3 Point Stainless Steel Swing Handle Padlockable*
IP-L039 - 316 Stainless Steel

Note: Items marked * are also suitable for 4 point

Custom Electrical Enclosures



IP Enclosures provide custom electrical enclosures that are designed and manufactured to meet your unique needs.

Electrical enclosures, cabinets and data racks are designed and manufactured to suit project specifications and unique needs. No matter how small, large or complex, we work with customers to meet project requirements.

Major Projects

We work with a wide range of customers world wide to provide custom electrical enclosures to meet project requirements. We can design and manufacture to meet existing specifications and drawings or can assist to develop these in conjunction with customers, consultants, end users and contractors.

Modifications to Standard Product

Do you buy electrical enclosures and then modify them by drilling, cutting holes or adding accessories? Save time, money and risk by ordering custom enclosures with holes pre-drilled and cut. We provide an economical alternative for customers who require modified 'custom' enclosures.

Certified IP Rated Enclosures

We are a specialist electrical enclosure brand that specialises in electrical enclosures. You can be confident that your custom enclosure conforms to IEC62208 and IEC/EN/AS60529. We provide custom enclosures up to IP69K, Nema 4x including IP55, IP56, IP65, IP66 and IP69K Hygienic rated enclosures.

Examples

- Non-standard shapes and sizes
- Holes and cut-outs
- Locking systems
- Ventilation
- Internal shelves & brackets
- Viewing windows
- Accessories fitted
- Custom powder-coat colour
- Custom graphic artwork
- Your Logo
- ...etc

Simply contact our customer support team and tell us what you need. Our support team will work with you to determine the best and most economical solution. We provide 2D drawings and 3D Models for approval prior to manufacture.



Colour Options



COLOUR CHART

Standard colours are shown in the colour chart below. All enclosures are supplied as RAL7035 Light Grey unless requested otherwise. Refer to tables for part number suffix. Other RAL colours available upon request.

RAL9016
(Traffic White)



RAL7035 - Standard
(Light Grey)



RAL 9005
(Jet Black)



RAL6005
(Moss Green)



RAL5015
(Sky Blue)



RAL2000
(Yellow Orange)



RAL3001
(R13 Signal Red)



[YOUR LOGO]
[Your Text]
Full Colour Logo
Full Colour Artwork

Degrees Of Protection - IP Ratings

United Kingdom Standard IEC/EN/AS60529 - Degrees of protection by enclosures (IP Code)

IEC/EN/AS60529 provides definitions for degrees of protection provided by enclosures of electrical equipment, with regard to protection of persons against access to hazardous parts inside the enclosure and protection of the equipment inside the enclosure against ingress of solid foreign objects and harmful effects due to the ingress of water.

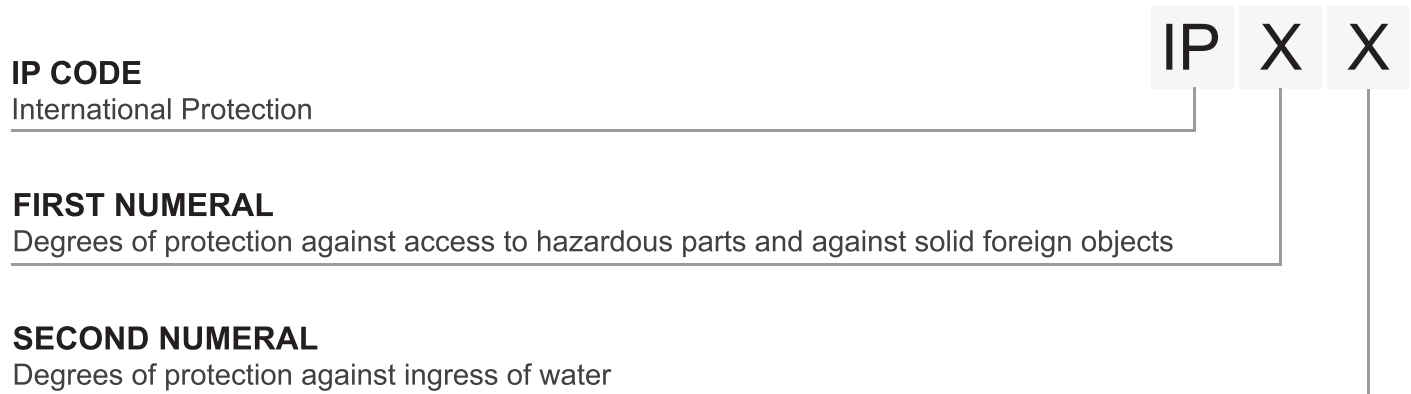

FIRST NUMERAL – Protection against solids/dust

- IP0X - No protection
- IP1X - Protection against solid objects > 50 mm
- IP2X - Protection against solid objects > 12 mm
- IP3X - Protection against solid objects > 2.5 mm
- IP4X - Protection against solid objects > 1 mm
- IP5X - Protection against dust (limited ingress allowed, no harmful deposit)
- IP6X - Fully protected from dust (dust tight)

SECOND NUMERAL – Protection against water

- IPX0 - No protection
- IPX1 - Protection from vertically dripping water
- IPX2 - Protection from sprays/dripping of water up to 15° from vertical
- IPX3 - Protection from spraying water up to 60° from vertical
- IPX4 - Protection from spraying water (all directions) – limited ingress acceptable if no hazard
- IPX5 - Protection from low pressure jets of water (all directions) – limited ingress acceptable if no hazard
- IPX6 - Protection against powerful jets of water, limited ingress acceptable if no hazard
- IPX7 - Protection from temporary immersion
- IPX8 - Protection from continuous immersion
- IPX9K - Protection from high pressure and temperature water jet (ISO 20653)



IP ENCLOSURES UK LIMITED

Company Number: 13240421

Head Office: Redcliffe House, Unit 11 Sherwood Road,
Bromsgrove, Worcestershire, B60 3DR

sales@ipenclosures.co.uk | www.ipenclosures.co.uk

Telephone: 01527 433383

GLOBAL DISTRIBUTION: AU NZ Europe USA UAE Asia-Pacific