

MasterFlow

THE NAME YOU CAN TRUST



PRODUCT GUIDE



Masterflow, the name you can trust, supplier of fit-for-purpose range of fittings, valves and accessories for the heating, plumbing and ventilation industry.

We are pleased to offer an extensive range of products that are designed to meet the expectations of you and your customers. These are fully backed by manufacturer

guarantees, service and commitment. MasterFlow offers great value for money.

This product guide, along with technical information, WRAS listings and installation tips, can be accessed and downloaded online via our website: www.masterflow.uk.com.



| | | | |
|---|---|---|---------------------------------------|
|  | End Feed Fittings2 |  | Flexi Hoses WRAS Approved.....60 |
|  | Solder Ring Fittings12 |  | Flexi Hoses Non WRAS Approved64 |
|  | Compression Fittings20 |  | Heating Products67 |
|  | DZR Compression Fittings26 |  | Gas Fittings.....78 |
|  | Chrome Plated Compression Fittings31 |  | Taps84 |
|  | Copper Pushfit Fittings34 |  | Showers.....95 |
|  | Yellow Brass40 |  | Traps & Wastes.....102 |
|  | |  | Fitting Specifications107 |

End Feed Fittings

- WRAS approved.
- Marked for full traceability.
- Supported by full manufacturer's warranty.
- Compliant with relevant British standards EN1254/BS864.
- Manufactured using high quality copper material in accordance with EN1254-2.

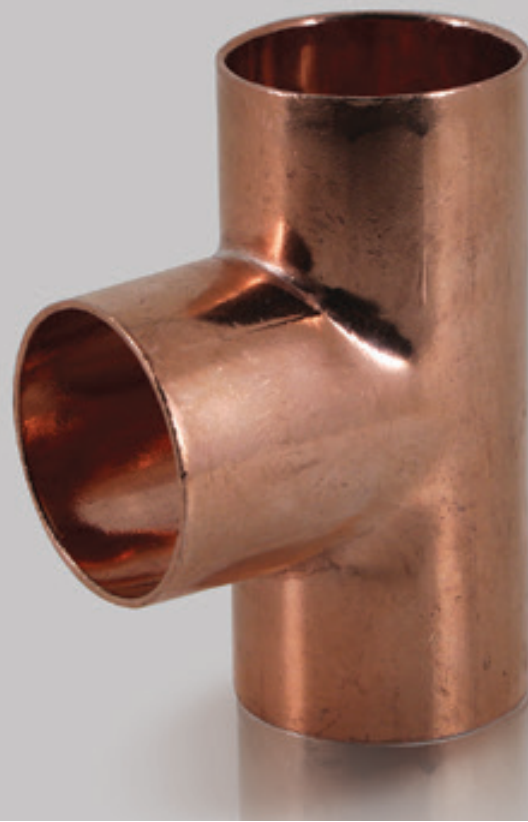

End Feed Fittings: Fitting Reducer

| MasterFlow Code | Size (mm) | Bag Qty | Box Qty |
|-----------------|-----------|---------|---------|
| MEF92100800 | 10 x 8 | 10 | 1000 |
| MEF92150800 | 15 x 8 | 10 | 500 |
| MEF92151000 | 15 x 10 | 10 | 500 |
| MEF92151200 | 15 x 12 | 10 | 600 |
| MEF92221500 | 22 x 15 | 10 | 250 |
| MEF92281500 | 28 x 15 | 10 | 150 |
| MEF92282200 | 28 x 22 | 10 | 150 |
| MEF92351500 | 35 x 15 | 5 | 250 |
| MEF92352200 | 35 x 22 | 5 | 150 |
| MEF92352800 | 35 x 28 | 5 | 200 |
| MEF92421500 | 42 x 15 | 5 | 70 |
| MEF92422200 | 42 x 22 | 5 | 70 |
| MEF92422800 | 42 x 28 | 5 | 100 |
| MEF92423500 | 42 x 35 | 5 | 100 |
| MEF92541500 | 54 x 15 | 5 | 70 |
| MEF92542200 | 54 x 22 | 5 | 70 |
| MEF92542800 | 54 x 28 | 5 | 70 |
| MEF92543500 | 54 x 35 | 5 | 54 |
| MEF92544200 | 54 x 42 | 5 | 60 |



End Feed Fittings: Straight Coupler



| MasterFlow Code | Size (mm) | Bag Qty | Box Qty |
|-----------------|-----------|---------|---------|
| MEF10080000 | 8 | 10 | 1000 |
| MEF10100000 | 10 | 10 | 1000 |
| MEF10150000 | 15 | 25 | 1000 |
| MEF10220000 | 22 | 25 | 400 |
| MEF10280000 | 28 | 10 | 200 |
| MEF10350000 | 35 | 10 | 100 |
| MEF10420000 | 42 | 5 | 100 |
| MEF10540000 | 54 | 5 | 40 |

End Feed Fittings: Fitting Reducer (Long)

| MasterFlow Code | Size (mm) | Bag Qty | Box Qty |
|-----------------|-----------|---------|---------|
| MEF92150800L | 15 x 8 | 10 | 600 |
| MEF92151000L | 15 x 10 | 10 | 500 |



End Feed Fittings: Reduced Coupler

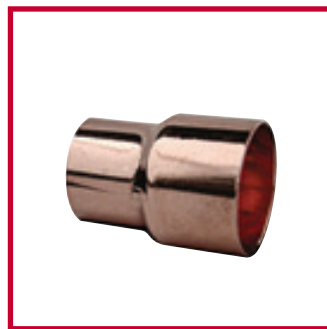

| MasterFlow Code | Size (mm) | Bag Qty | Box Qty |
|-----------------|-----------|---------|---------|
| MEF10100800 | 10 x 8 | 10 | 500 |
| MEF10150800 | 15 x 8 | 10 | 600 |
| MEF10151000 | 15 x 10 | 10 | 600 |
| MEF10151200 | 15 x 12 | 10 | 600 |
| MEF10221500 | 22 x 15 | 10 | 250 |
| MEF10281500 | 28 x 15 | 10 | 150 |
| MEF10282200 | 28 x 22 | 10 | 150 |
| MEF10352200 | 35 x 22 | 5 | 150 |
| MEF10352800 | 35 x 28 | 5 | 80 |
| MEF10422200 | 42 x 22 | 5 | 60 |
| MEF10422800 | 42 x 28 | 5 | 60 |
| MEF10423500 | 42 x 35 | 5 | 70 |
| MEF10543500 | 54 x 35 | 5 | 60 |
| MEF10544200 | 54 x 42 | 2 | 50 |

End Feed Fittings: Imperial/Metric Coupler

| MasterFlow Code | Size (mm) | Bag Qty | Box Qty |
|-----------------|-----------|---------|---------|
| MEF92150400 | 1/2" x 15 | 10 | 500 |
| MEF92220600 | 3/4" x 22 | 10 | 200 |
| MEF92280800 | 1" x 28 | 10 | 100 |



End Feed Fittings: Slip Coupler



| MasterFlow Code | Size (mm) | Bag Qty | Box Qty |
|-----------------|-----------|---------|---------|
| MEF81150000 | 15 | 10 | 500 |
| MEF81220000 | 22 | 10 | 200 |
| MEF81280000 | 28 | 10 | 200 |

End Feed Fittings: C x FI Straight Coupler



| MasterFlow Code | Size (mm) | Bag Qty | Box Qty |
|-----------------|-------------|---------|---------|
| MEF12150400 | 15 x 1/2" | 10 | 470 |
| MEF12150600 | 15 x 3/4" | 10 | 300 |
| MEF12220600 | 22 x 3/4" | 10 | 200 |
| MEF12280800 | 28 x 1" | 10 | 110 |
| MEF12351000 | 35 x 1.1/4" | 5 | 70 |
| MEF12421200 | 42 x 1.1/2" | 5 | 50 |
| MEF12541600 | 54 x 2" | 5 | 30 |

End Feed Fittings: C x MI Straight Coupler



| MasterFlow Code | Size (mm) | Bag Qty | Box Qty |
|-----------------|-------------|---------|---------|
| MEF11150200 | 15 x 1/4" | 2 | 600 |
| MEF11150400 | 15 x 1/2" | 10 | 550 |
| MEF11220400 | 22 x 1/2" | 10 | 300 |
| MEF11220600 | 22 x 3/4" | 2 | 250 |
| MEF11280800 | 28 x 1" | 2 | 160 |
| MEF11351000 | 35 x 1.1/4" | 2 | 100 |
| MEF11421200 | 42 x 1.1/2" | 2 | 60 |
| MEF11541600 | 54 x 2" | 2 | 72 |

End Feed Fittings: C x FI Elbow



| MasterFlow Code | Size (mm) | Bag Qty | Box Qty |
|-----------------|-----------|---------|---------|
| MEF18150400 | 15 x 1/2" | 2 | 300 |
| MEF18220600 | 22 x 3/4" | 2 | 130 |

End Feed Fittings: C x MI Elbow

| MasterFlow Code | Size (mm) | Bag Qty | Box Qty |
|-----------------|-----------|---------|---------|
| MEF17150400 | 15 x 1/2" | 2 | 300 |
| MEF17220600 | 22 x 3/4" | 2 | 130 |



End Feed Fittings: 90deg. Elbow

| MasterFlow Code | Size (mm) | Bag Qty | Box Qty |
|-----------------|-----------|---------|---------|
| MEF16080000 | 8 | 10 | 1000 |
| MEF16100000 | 10 | 10 | 1000 |
| MEF16150000 | 15 | 25 | 1000 |
| MEF16220000 | 22 | 25 | 300 |
| MEF16280000 | 28 | 10 | 150 |
| MEF16350000 | 35 | 5 | 100 |
| MEF16420000 | 42 | 5 | 50 |
| MEF16540000 | 54 | 5 | 20 |



End Feed Fittings: 90deg. Street Elbow

| MasterFlow Code | Size (mm) | Bag Qty | Box Qty |
|-----------------|-----------|---------|---------|
| MEF94100000 | 10 | 10 | 300 |
| MEF94150000 | 15 | 25 | 500 |
| MEF94220000 | 22 | 10 | 300 |
| MEF94280000 | 28 | 10 | 150 |
| MEF94350000 | 35 | 5 | 100 |
| MEF94420000 | 42 | 5 | 50 |
| MEF94540000 | 54 | 2 | 20 |



End Feed Fittings: Obtuse Street Elbow

| MasterFlow Code | Size (mm) | Bag Qty | Box Qty |
|-----------------|-----------|---------|---------|
| MEF95150000 | 15 | 25 | 600 |
| MEF95220000 | 22 | 25 | 250 |
| MEF95280000 | 28 | 10 | 150 |
| MEF95350000 | 35 | 5 | 60 |
| MEF95420000 | 42 | 5 | 40 |
| MEF95540000 | 54 | 2 | 30 |



End Feed Fittings: End Feed Long Radius Street Elbow



| MasterFlow Code | Size (mm) | Bag Qty | Box Qty |
|-----------------|-----------|---------|---------|
| MEF97150000 | 15 | 10 | 300 |
| MEF97220000 | 22 | 10 | 120 |
| MEF97280000 | 28 | 5 | 60 |
| MEF97350000 | 35 | 5 | 30 |
| MEF97420000 | 42 | 2 | 20 |
| MEF97540000 | 54 | 2 | 8 |

End Feed Fittings: 45deg. Obtuse Elbow



| MasterFlow Code | Size (mm) | Bag Qty | Box Qty |
|-----------------|-----------|---------|---------|
| MEF93150000 | 15 | 25 | 500 |
| MEF93220000 | 22 | 10 | 300 |
| MEF93280000 | 28 | 10 | 100 |
| MEF93350000 | 35 | 10 | 100 |
| MEF93420000 | 42 | 10 | 70 |
| MEF93540000 | 54 | 2 | 26 |

End Feed Fittings: Wallplate Elbow



| MasterFlow Code | Size (mm) | Bag Qty | Box Qty |
|-----------------|-----------|---------|---------|
| MEF19150400 | 15 x 1/2" | 2 | 220 |

End Feed Fittings: Part Crossover



| MasterFlow Code | Size (mm) | Bag Qty | Box Qty |
|-----------------|-----------|---------|---------|
| MEF85150000 | 15 | 10 | 100 |
| MEF85220000 | 22 | 10 | 80 |

End Feed Fittings: Full Crossover



| MasterFlow Code | Size (mm) | Bag Qty | Box Qty |
|-----------------|-----------|---------|---------|
| MEF86150000 | 15 | 10 | 100 |
| MEF86220000 | 22 | 10 | 100 |

End Feed Fittings: Equal Tee



| MasterFlow Code | Size (mm) | Bag Qty | Box Qty |
|-----------------|-----------|---------|---------|
| MEF20080000 | 8 | 10 | 800 |
| MEF20100000 | 10 | 10 | 500 |
| MEF20150000 | 15 | 25 | 500 |
| MEF20220000 | 22 | 25 | 200 |
| MEF20280000 | 28 | 10 | 100 |
| MEF20350000 | 35 | 5 | 70 |
| MEF20420000 | 42 | 5 | 40 |
| MEF20540000 | 54 | 5 | 15 |

End Feed Fittings: Reduced Branch Tee



| MasterFlow Code | Size (mm) AxBxC | Bag Qty | Box Qty |
|-----------------|-----------------|---------|---------|
| MEF20151510 | 15 x 15 x 10 | 10 | 300 |
| MEF20222215 | 22 x 22 x 15 | 10 | 250 |
| MEF20282815 | 28 x 28 x 15 | 10 | 100 |
| MEF20282822 | 28 x 28 x 22 | 10 | 100 |
| MEF20353515 | 35 x 35 x 15 | 5 | 100 |
| MEF20353522 | 35 x 35 x 22 | 5 | 80 |
| MEF20353528 | 35 x 35 x 28 | 5 | 70 |
| MEF20424215 | 42 x 42 x 15 | 5 | 50 |
| MEF20424222 | 42 x 42 x 22 | 5 | 50 |
| MEF20424228 | 42 x 42 x 28 | 5 | 50 |
| MEF20424235 | 42 x 42 x 35 | 5 | 40 |
| MEF20545415 | 54 x 54 x 15 | 5 | 25 |
| MEF20545422 | 54 x 54 x 22 | 5 | 25 |
| MEF20545428 | 54 x 54 x 28 | 5 | 25 |
| MEF20545435 | 54 x 54 x 35 | 5 | 25 |
| MEF20545442 | 54 x 54 x 42 | 5 | 20 |

End Feed Fittings: Reduced End Tee



| MasterFlow Code | Size (mm) AxBxC | Bag Qty | Box Qty |
|-----------------|-----------------|---------|---------|
| MEF20221522 | 22 x 15 x 22 | 10 | 200 |
| MEF20222815 | 22 x 28 x 15 | 10 | 100 |
| MEF20281528 | 28 x 15 x 28 | 10 | 100 |
| MEF20282228 | 28 x 22 x 28 | 10 | 100 |
| MEF20352235 | 35 x 22 x 35 | 5 | 40 |
| MEF20352835 | 35 x 28 x 35 | 5 | 40 |
| MEF20423542 | 42 x 35 x 42 | 5 | 40 |
| MEF20544254 | 54 x 42 x 54 | 5 | 15 |

End Feed Fittings: Reduced End & Branch Tee



| MasterFlow Code | Size (mm) AxBxC | Bag Qty | Box Qty |
|-----------------|-----------------|---------|---------|
| MEF20221515 | 22 x 15 x 15 | 10 | 250 |
| MEF20281515 | 28 x 15 x 15 | 10 | 100 |
| MEF20281522 | 28 x 15 x 22 | 10 | 100 |
| MEF20282215 | 28 x 22 x 15 | 10 | 80 |
| MEF20282222 | 28 x 22 x 22 | 10 | 100 |
| MEF20352815 | 35 x 28 x 15 | 5 | 40 |
| MEF20352822 | 35 x 28 x 22 | 5 | 40 |
| MEF20352828 | 35 x 28 x 28 | 5 | 70 |
| MEF20423528 | 42 x 35 x 28 | 5 | 40 |
| MEF20423535 | 42 x 35 x 35 | 5 | 40 |
| MEF20544242 | 54 x 42 x 42 | 5 | 20 |

End Feed Fittings: Both Ends Reduced Tee



| MasterFlow Code | Size (mm) AxBxC | Bag Qty | Box Qty |
|-----------------|-----------------|---------|---------|
| MEF20151522 | 15 x 15 x 22 | 10 | 250 |
| MEF20222228 | 22 x 22 x 28 | 10 | 100 |

End Feed Fittings: FI Tee (FI On Run)

| MasterFlow Code | Size (mm) AxBxC | Bag Qty | Box Qty |
|-----------------|-----------------|---------|---------|
| MEF27150415 | 15 x 1/2" x 15 | 2 | 250 |
| MEF27220422 | 22 x 1/2" x 22 | 2 | 120 |



End Feed Fittings: FI Tee (FI On Branch)

| MasterFlow Code | Size (mm) AxBxC | Bag Qty | Box Qty |
|-----------------|-----------------|---------|---------|
| MEF27151504 | 15 x 15 x 1/2" | 2 | 250 |
| MEF27222204 | 22 x 22 x 1/2" | 10 | 120 |
| MEF27222206 | 22 x 22 x 3/4" | 2 | 80 |



End Feed Fittings: Extended Street Elbow

| MasterFlow Code | Size (mm) AxB | Bag Qty | Box Qty |
|-----------------|---------------|---------|---------|
| MEF94150000E | 15 x 150 | 5 | 20 |



End Feed Fittings: Stop End

| MasterFlow Code | Size (mm) | Bag Qty | Box Qty |
|-----------------|-----------|---------|---------|
| MEF15080000 | 8 | 10 | 2000 |
| MEF15100000 | 10 | 10 | 1000 |
| MEF15150000 | 15 | 10 | 1000 |
| MEF15220000 | 22 | 10 | 400 |
| MEF15280000 | 28 | 10 | 150 |
| MEF15350000 | 35 | 2 | 130 |
| MEF15420000 | 42 | 5 | 200 |
| MEF15540000 | 54 | 2 | 50 |



End Feed Fittings: Straight Tap Connector



| MasterFlow Code | Size (mm) | Bag Qty | Box Qty |
|-----------------|-----------|---------|---------|
| MEF13150400 | 15 x 1/2" | 5 | 500 |
| MEF13150600 | 15 x 3/4" | 5 | 200 |
| MEF13220600 | 22 x 3/4" | 5 | 200 |

End Feed Fittings: Bent Tap Connector



| MasterFlow Code | Size (mm) | Bag Qty | Box Qty |
|-----------------|-----------|---------|---------|
| MEF24150400 | 15 x 1/2" | 10 | 250 |
| MEF24150600 | 15 x 3/4" | 2 | 200 |
| MEF24220600 | 22 x 3/4" | 2 | 150 |

End Feed Fittings: Bent Union Adaptor



| MasterFlow Code | Size (mm) | Bag Qty | Box Qty |
|-----------------|-----------|---------|---------|
| MEF31220800 | 22 x 1" | 2 | 100 |

End Feed Fittings: Straight Union Adaptor



| MasterFlow Code | Size (mm) | Bag Qty | Box Qty |
|-----------------|-----------|---------|---------|
| MEF29220600 | 22 x 3/4" | 2 | 150 |
| MEF29220800 | 22 x 1" | 2 | 140 |
| MEF29280800 | 28 x 1" | 2 | 80 |

End Feed Fittings: Air Vent Cap



| MasterFlow Code | Size (mm) | Bag Qty | Box Qty |
|-----------------|-----------|---------|---------|
| MEF99150000 | 15 | 2 | 500 |
| MEF99220000 | 22 | 10 | 450 |

End Feed Fittings: U Bend



| MasterFlow Code | Size (mm) | Bag Qty | Box Qty |
|-----------------|-----------|---------|---------|
| MEFUBEND15S | 15 | 10 | 450 |

End Feed Fittings: Pack (MEFFITPK0003)



| Product Code | Name | Size | Qty |
|--------------|-----------------|---------|-----|
| MEF10150000 | Coupler | 15 | 60 |
| MEF10220000 | Coupler | 22 | 10 |
| MEF16150000 | Elbow | 15 | 60 |
| MEF16220000 | Elbow | 22 | 20 |
| MEF20150000 | Equal Tee | 15 | 10 |
| MEF20220000 | Equal Tee | 22 | 10 |
| MEF92221500 | Fitting Reducer | 22 x 15 | 10 |

Solder Ring Fittings

- WRAS approved.
- Marked for full traceability.
- Supported by full manufacturer's warranty.
- Compliant with relevant British standards – EN1254/BS864.
- Manufactured using high quality copper material in accordance with EN1254-2.



Solder Ring Fittings: Straight Coupler



| MasterFlow Code | Size (mm) | Bag Qty | Box Qty |
|-----------------|-----------|---------|---------|
| MSR10080000 | 8 | 10 | 1000 |
| MSR10100000 | 10 | 10 | 1000 |
| MSR10150000 | 15 | 25 | 1000 |
| MSR10220000 | 22 | 25 | 400 |
| MSR10280000 | 28 | 10 | 200 |
| MSR10350000 | 35 | 10 | 100 |
| MSR10420000 | 42 | 2 | 100 |
| MSR10540000 | 54 | 5 | 50 |

Solder Ring Fittings: Reduced Coupler



| MasterFlow Code | Size (mm) | Bag Qty | Box Qty |
|-----------------|-----------|---------|---------|
| MSR10100800 | 10 x 8 | 2 | 2000 |
| MSR10150800 | 15 x 8 | 2 | 1000 |
| MSR10151000 | 15 x 10 | 5 | 1000 |
| MSR10221500 | 22 x 15 | 10 | 500 |
| MSR10281500 | 28 x 15 | 2 | 200 |
| MSR10282200 | 28 x 22 | 2 | 200 |
| MSR10352200 | 35 x 22 | 2 | 150 |
| MSR10352800 | 35 x 28 | 2 | 120 |
| MSR10422800 | 42 x 28 | 2 | 100 |
| MSR10423500 | 42 x 35 | 2 | 70 |
| MSR10543500 | 54 x 35 | 2 | 50 |
| MSR10544200 | 54 x 42 | 2 | 50 |

Solder Ring Fittings: Fitting Reducer

| MasterFlow Code | Size (mm) | Bag Qty | Box Qty |
|-----------------|-----------|---------|---------|
| MSR91100800 | 10 x 8 | 2 | 2000 |
| MSR91120800 | 12 x 8 | 2 | 1000 |
| MSR91150800 | 15 x 8 | 10 | 800 |
| MSR91151000 | 15 x 10 | 5 | 1000 |
| MSR91151200 | 15 x 12 | 10 | 600 |
| MSR91221500 | 22 x 15 | 10 | 500 |
| MSR91281500 | 28 x 15 | 2 | 200 |
| MSR91282200 | 28 x 22 | 2 | 200 |
| MSR91351500 | 35 x 15 | 2 | 150 |
| MSR91352200 | 35 x 22 | 2 | 140 |
| MSR91352800 | 35 x 28 | 2 | 120 |
| MSR91421500 | 42 x 15 | 2 | 100 |
| MSR91422200 | 42 x 22 | 2 | 100 |
| MSR91422800 | 42 x 28 | 2 | 100 |
| MSR91423500 | 42 x 35 | 2 | 80 |
| MSR91541500 | 54 x 15 | 2 | 60 |
| MSR91542200 | 54 x 22 | 2 | 60 |
| MSR91542800 | 54 x 28 | 2 | 60 |
| MSR91543500 | 54 x 35 | 2 | 60 |
| MSR91544200 | 54 x 42 | 2 | 50 |



Solder Ring Fittings: Reducer Long

| MasterFlow Code | Size (mm) | Bag Qty | Box Qty |
|-----------------|-----------|---------|---------|
| MSR91150800L | 15 X 8 | 10 | 600 |
| MSR91151000L | 15 x 10 | 10 | 600 |



Solder Ring Fittings: Imperial/Metric Coupler

| MasterFlow Code | Size (mm) | Bag Qty | Box Qty |
|-----------------|-------------|---------|---------|
| MSR92150400 | 15 x 1/2 | 2 | 600 |
| MSR92220600 | 22 x 3/4 | 2 | 300 |
| MSR92280800 | 28 x 1" | 2 | 150 |
| MSR92351000 | 35 x 1.1/4" | 2 | 90 |



Solder Ring Fittings: Slip Coupler



| MasterFlow Code | Size (mm) | Bag Qty | Box Qty |
|-----------------|-----------|---------|---------|
| MSR81150000 | 15 | 5 | 700 |
| MSR81220000 | 22 | 5 | 300 |

Solder Ring Fittings: C x FI Straight Coupler



| MasterFlow Code | Size (mm) | Bag Qty | Box Qty |
|-----------------|-------------|---------|---------|
| MSR12150400 | 15 x 1/2" | 2 | 470 |
| MSR12220600 | 22 x 3/4" | 2 | 300 |
| MSR12280800 | 28 x 1" | 2 | 110 |
| MSR12351000 | 35 x 1.1/4" | 2 | 70 |
| MSR12421200 | 42 x 1.1/2" | 2 | 50 |
| MSR12541600 | 54 x 2" | 2 | 26 |

Solder Ring Fittings: C x MI Straight Coupler



| MasterFlow Code | Size (mm) | Bag Qty | Box Qty |
|-----------------|-------------|---------|---------|
| MSR11150400 | 15 x 1/2" | 2 | 550 |
| MSR11220600 | 22 x 3/4" | 2 | 250 |
| MSR11280800 | 28 x 1" | 2 | 160 |
| MSR11351000 | 35 x 1.1/4" | 2 | 100 |
| MSR11421200 | 42 x 1.1/2" | 2 | 60 |
| MSR11541600 | 54 x 2" | 2 | 30 |

Solder Ring Fittings: 90deg. Elbow



| MasterFlow Code | Size (mm) | Bag Qty | Box Qty |
|-----------------|-----------|---------|---------|
| MSR16080000 | 8 | 2 | 2500 |
| MSR16100000 | 10 | 2 | 1000 |
| MSR16150000 | 15 | 10 | 500 |
| MSR16220000 | 22 | 10 | 200 |
| MSR16280000 | 28 | 2 | 120 |
| MSR16350000 | 35 | 2 | 50 |
| MSR16420000 | 42 | 2 | 30 |
| MSR16540000 | 54 | 2 | 14 |

Solder Ring Fittings: 90deg. Street Elbow



| MasterFlow Code | Size (mm) | Bag Qty | Box Qty |
|-----------------|-----------|---------|---------|
| MSR94150000 | 15 | 10 | 600 |
| MSR94220000 | 22 | 5 | 250 |
| MSR94280000 | 28 | 5 | 120 |

Solder Ring Fittings: 45deg. Obtuse Elbow



| MasterFlow Code | Size (mm) | Bag Qty | Box Qty |
|-----------------|-----------|---------|---------|
| MSR93150000 | 15 | 5 | 500 |
| MSR93220000 | 22 | 5 | 200 |
| MSR93280000 | 28 | 2 | 100 |
| MSR93350000 | 35 | 2 | 60 |
| MSR93420000 | 42 | 2 | 40 |
| MSR93540000 | 54 | 2 | 18 |

Solder Ring Fittings: C x MI Elbow



| MasterFlow Code | Size (mm) | Bag Qty | Box Qty |
|-----------------|-----------|---------|---------|
| MSR17150400 | 15 x 1/2" | 2 | 150 |
| MSR17220600 | 22 x 3/4" | 2 | 70 |

Solder Ring Fittings: C x FI Elbow



| MasterFlow Code | Size (mm) | Bag Qty | Box Qty |
|-----------------|-----------|---------|---------|
| MSR18150400 | 15 x 1/2" | 2 | 150 |

Solder Ring Fittings: Wallplate Elbow



| MasterFlow Code | Size (mm) | Bag Qty | Box Qty |
|-----------------|-----------|---------|---------|
| MSR19150400 | 15 x 1/2" | 2 | 220 |

Solder Ring Fittings: Equal Tee



| MasterFlow Code | Size (mm) | Bag Qty | Box Qty |
|-----------------|-----------|---------|---------|
| MSR20100000 | 10 | 2 | 1000 |
| MSR20150000 | 15 | 10 | 350 |
| MSR20220000 | 22 | 10 | 125 |
| MSR20280000 | 28 | 2 | 70 |
| MSR20350000 | 35 | 2 | 30 |
| MSR20420000 | 42 | 2 | 20 |
| MSR20540000 | 54 | 2 | 12 |

Solder Ring Fittings: Reduced Branch Tee



| MasterFlow Code | Size (mm) AxBxC | Bag Qty | Box Qty |
|-----------------|-----------------|---------|---------|
| MSR20151510 | 15 x 15 x 10 | 5 | 200 |
| MSR20222215 | 22 x 22 x 15 | 5 | 175 |
| MSR20282815 | 28 x 28 x 15 | 2 | 100 |
| MSR20282822 | 28 x 28 x 22 | 2 | 80 |
| MSR20353515 | 35 x 35 x 15 | 2 | 50 |
| MSR20353522 | 35 x 35 x 22 | 2 | 50 |
| MSR20353528 | 35 x 35 x 28 | 2 | 45 |
| MSR20424215 | 42 x 42 x 15 | 2 | 40 |
| MSR20424222 | 42 x 42 x 22 | 2 | 35 |
| MSR20424228 | 42 x 42 x 28 | 2 | 30 |
| MSR20424235 | 42 x 42 x 35 | 2 | 20 |
| MSR20545415 | 54 x 54 x 15 | 2 | 20 |
| MSR20545422 | 54 x 54 x 22 | 2 | 20 |
| MSR20545428 | 54 x 54 x 28 | 2 | 20 |
| MSR20545435 | 54 x 54 x 35 | 2 | 20 |
| MSR20545442 | 54 x 54 x 42 | 2 | 14 |

Solder Ring Fittings: Reduced End Tee



| MasterFlow Code | Size (mm) AxBxC | Bag Qty | Box Qty |
|-----------------|-----------------|---------|---------|
| MSR20221522 | 22 x 15 x 22 | 5 | 125 |
| MSR20222828 | 22 x 28 x 28 | 2 | 50 |
| MSR20282215 | 28 x 22 x 15 | 2 | 50 |
| MSR20281528 | 28 x 15 x 28 | 2 | 80 |
| MSR20282228 | 28 x 22 x 28 | 2 | 70 |

Solder Ring Fittings: Reduced End & Branch Tee



| MasterFlow Code | Size (mm) AxBxC | Bag Qty | Box Qty |
|-----------------|-----------------|---------|---------|
| MSR20221515 | 22 x 15 x 15 | 5 | 200 |
| MSR20282222 | 28 x 22 x 22 | 2 | 100 |

Solder Ring Fittings: Both Ends Reduced Tee



| MasterFlow Code | Size (mm) AxBxC | Bag Qty | Box Qty |
|-----------------|-----------------|---------|---------|
| MSR20151522 | 15 x 15 x 22 | 5 | 200 |

Solder Ring Fittings: FI Tee (FI On Branch)



| MasterFlow Code | Size (mm) AxBxC | Bag Qty | Box Qty |
|-----------------|-----------------|---------|---------|
| MSR27151504 | 15 x 15 x 1/2" | 2 | 250 |
| MSR27222204 | 22 x 22 x 1/2" | 2 | 140 |
| MSR27222206 | 22 x 22 x 3/4" | 2 | 140 |
| MSR27282804 | 28 x 28 x 1/2" | 2 | 70 |

Solder Ring Fittings: FI Tee (FI On End)



| MasterFlow Code | Size (mm) AxBxC | Bag Qty | Box Qty |
|-----------------|-----------------|---------|---------|
| MSR27220422 | 22 x 1/2" x 22 | 2 | 140 |

Solder Ring Fittings: Stop End



| MasterFlow Code | Size (mm) | Bag Qty | Box Qty |
|-----------------|-----------|---------|---------|
| MSR15100000 | 10 | 5 | 4000 |
| MSR15150000 | 15 | 5 | 1600 |
| MSR15220000 | 22 | 5 | 600 |
| MSR15280000 | 28 | 2 | 400 |
| MSR15350000 | 35 | 2 | 150 |
| MSR15420000 | 42 | 2 | 100 |
| MSR15540000 | 54 | 2 | 50 |

Solder Ring Fittings: Straight Tap Connector



| MasterFlow Code | Size (mm) | Bag Qty | Box Qty |
|-----------------|-----------|---------|---------|
| MSR13150400 | 15 x 1/2" | 2 | 450 |
| MSR13150600 | 15 x 3/4" | 2 | 200 |
| MSR13220600 | 22 x 3/4" | 2 | 200 |

Solder Ring Fittings: Bent Tap Connector



| MasterFlow Code | Size (mm) | Bag Qty | Box Qty |
|-----------------|-----------|---------|---------|
| MSR24150400 | 15 x 1/2" | 2 | 400 |
| MSR24220600 | 22 x 3/4" | 2 | 150 |

Solder Ring Fittings: Bent Union Adaptor

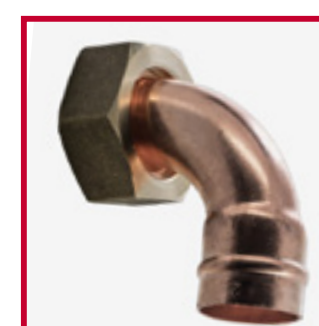

| MasterFlow Code | Size (mm) | Bag Qty | Box Qty |
|-----------------|-----------|---------|---------|
| MSR31220800 | 22 x 1" | 2 | 100 |

Solder Ring Fittings: Straight Union Adaptor



| MasterFlow Code | Size (mm) | Bag Qty | Box Qty |
|-----------------|-----------|---------|---------|
| MSR29220800 | 22 x 1" | 2 | 200 |

Compression Fittings

- WRAS approved.
- Marked for full traceability.
- Supported by full manufacturer's warranty.
- Compliant with relevant British standards – EN1254/BS864.
- Manufactured using high quality brass material.



Compression Fittings: Straight Coupler



| MasterFlow Code | Size (mm) | Bag Qty | Box Qty |
|-----------------|-----------|---------|---------|
| M10080000 | 8 | 10 | 250 |
| M10100000 | 10 | 10 | 250 |
| M10150000 | 15 | 10 | 200 |
| M10220000 | 22 | 10 | 100 |
| M10280000 | 28 | 10 | 50 |
| M10350000 | 35 | 2 | 40 |
| M10420000 | 42 | 2 | 30 |
| M10540000 | 54 | 2 | 20 |

Compression Fittings: Reduced Coupler



| MasterFlow Code | Size (mm) | Bag Qty | Box Qty |
|-----------------|-----------|---------|---------|
| M10100800 | 10 x 8 | 2 | 250 |
| M10150800 | 15 x 8 | 2 | 200 |
| M10151000 | 15 x 10 | 2 | 250 |
| M10151200 | 15 x 12 | 2 | 200 |
| M10161500 | 16 x 15 | 10 | 200 |
| M10181500 | 18 x 15 | 10 | 200 |
| M10221500 | 22 x 15 | 5 | 150 |
| M10281500 | 28 x 15 | 2 | 100 |
| M10282200 | 28 x 22 | 2 | 100 |

Compression Fittings: Repair Coupler

| MasterFlow Code | Size (mm) | Bag Qty | Box Qty |
|-----------------|-----------|---------|---------|
| M10159650 | 15 | 2 | 100 |
| M10228000 | 22 | 2 | 50 |



Compression Fittings: C x FI Straight Coupler

| MasterFlow Code | Size (mm) | Bag Qty | Box Qty |
|-----------------|-------------|---------|---------|
| M12080200 | 8 x 1/4" | 2 | 250 |
| M12080300 | 8 x 3/8" | 2 | 250 |
| M12100200 | 10 x 1/4" | 2 | 300 |
| M12100300 | 10 x 3/8" | 2 | 300 |
| M12100400 | 10 x 1/2" | 2 | 250 |
| M12150200 | 15 x 1/4" | 2 | 200 |
| M12150300 | 15 x 3/8" | 2 | 200 |
| M12150400 | 15 x 1/2" | 10 | 200 |
| M12150600 | 15 x 3/4" | 5 | 200 |
| M12220400 | 22 x 1/2" | 2 | 150 |
| M12220600 | 22 x 3/4" | 2 | 150 |
| M12220800 | 22 x 1" | 2 | 100 |
| M12280800 | 28 x 1" | 2 | 100 |
| M12351000 | 35 x 1.1/4" | 2 | 40 |
| M12421200 | 42 x 1.1/2" | 2 | 40 |
| M12541600 | 54 x 2" | 2 | 20 |



Compression Fittings: C x MI Straight Coupler



| MasterFlow Code | Size (mm) | Bag Qty | Box Qty |
|----------------------|-------------|---------|---------|
| M11080200 | 8 x 1/4" | 2 | 300 |
| M11080300 | 8 x 3/8" | 2 | 300 |
| M11100200 | 10 x 1/4" | 2 | 300 |
| M11100300 | 10 x 3/8" | 2 | 300 |
| M11100400 | 10 x 1/2" | 2 | 250 |
| M11150200 | 15 x 1/4" | 2 | 200 |
| M11150300 | 15 x 3/8" | 2 | 200 |
| M11150400 | 15 x 1/2" | 10 | 200 |
| M11150400T (Tapered) | 15 x 1/2" | 10 | 200 |
| M11150600 | 15 x 3/4" | 5 | 200 |
| M11220400 | 22 x 1/2" | 2 | 150 |
| M11220600 | 22 x 3/4" | 2 | 150 |
| M11220600T (Tapered) | 22 x 3/4" | 2 | 150 |
| M11220800 | 22 x 1" | 2 | 100 |
| M11280600T (Tapered) | 28 x 3/4" | 2 | 100 |
| M11280800 | 28 x 1" | 2 | 100 |
| M11281000 | 28 x 1.1/4" | 2 | 60 |
| M11351000 | 35 x 1.1/4" | 2 | 30 |
| M11421200 | 42 x 1.1/2" | 2 | 40 |
| M11541600 | 54 x 2" | 2 | 14 |

Compression Fittings: C x FI Elbow



| MasterFlow Code | Size (mm) | Bag Qty | Box Qty |
|-----------------|-------------|---------|---------|
| M18150400 | 15 x 1/2" | 5 | 150 |
| M18150600 | 15 x 3/4" | 5 | 150 |
| M18220600 | 22 x 3/4" | 5 | 100 |
| M18220800 | 22 x 1" | 5 | 100 |
| M18280800 | 28 x 1" | 2 | 50 |
| M18351000 | 35 x 1.1/4" | 2 | 30 |
| M18421200 | 42 x 1.1/2" | 2 | 24 |
| M18541600 | 54 x 2" | 2 | 14 |

Compression Fittings: C x MI Elbow



| MasterFlow Code | Size (mm) | Bag Qty | Box Qty |
|------------------------|-------------|---------|---------|
| M17100300 | 10 x 3/8" | 2 | 200 |
| M17150400 | 15 x 1/2" | 5 | 150 |
| M17150600 | 15 x 3/4" | 5 | 150 |
| M17220600 | 22 x 3/4" | 5 | 100 |
| M17220600D (Drain off) | 22 x 3/4" | 2 | 50 |
| M17220800 | 22 x 1" | 5 | 100 |
| M17280800 | 28 x 1" | 2 | 50 |
| M17280800T (Tapered) | 28 x 1" | 2 | 50 |
| M17351000 | 35 x 1.1/4" | 2 | 30 |
| M17421200 | 42 x 1.1/2" | 2 | 30 |
| M17541600 | 54 x 2" | 2 | 14 |

Compression Fittings: 90deg. Elbow



| MasterFlow Code | Size (mm) | Bag Qty | Box Qty |
|-----------------|-----------|---------|---------|
| M16080000 | 8 | 10 | 300 |
| M16100000 | 10 | 10 | 250 |
| M16150000 | 15 | 10 | 200 |
| M16220000 | 22 | 10 | 100 |
| M16280000 | 28 | 5 | 50 |
| M16350000 | 35 | 2 | 40 |
| M16420000 | 42 | 2 | 26 |
| M16540000 | 54 | 2 | 10 |

Compression Fittings: Wallplate Elbow

| MasterFlow Code | Size (mm) | Bag Qty | Box Qty |
|-----------------|-----------|---------|---------|
| M19150400 | 15 x 1/2" | 2 | 100 |
| M19220600 | 22 x 3/4" | 2 | 50 |



Compression Fittings: Equal Tee

| MasterFlow Code | Size (mm) | Bag Qty | Box Qty |
|-----------------|-----------|---------|---------|
| M20080000 | 8 | 10 | 250 |
| M20100000 | 10 | 10 | 200 |
| M20150000 | 15 | 10 | 100 |
| M20220000 | 22 | 10 | 50 |
| M20280000 | 28 | 5 | 40 |
| M20350000 | 35 | 2 | 26 |
| M20420000 | 42 | 2 | 14 |
| M20540000 | 54 | 2 | 10 |



Compression Fittings: Reducing Tee

| MasterFlow Code | Size (mm) AxBxC | Bag Qty | Box Qty |
|-----------------|-----------------|---------|---------|
| M20151510 | 15 x 15 x 10 | 2 | 100 |
| M20151522 | 15 x 15 x 22 | 2 | 100 |
| M20222215 | 22 x 22 x 15 | 2 | 50 |
| M20221522 | 22 x 15 x 22 | 2 | 50 |
| M20221515 | 22 x 15 x 15 | 2 | 50 |
| M20282815 | 28 x 28 x 15 | 2 | 50 |
| M20282822 | 28 x 28 x 22 | 2 | 40 |
| M20282222 | 28 x 22 x 22 | 2 | 40 |
| M20281528 | 28 x 15 x 28 | 2 | 40 |
| M20282228 | 28 x 22 x 28 | 2 | 40 |



Compression Fittings: C x C x FI Reducing Tee



| MasterFlow Code | Size (mm) AxBxC | Bag Qty | Box Qty |
|-----------------|-----------------|---------|---------|
| M27151504 | 15 x 15 x 1/2" | 2 | 100 |
| M27150415 | 15 x 1/2" x 15 | 2 | 50 |
| M27222204 | 22 x 22" x 1/2" | 2 | 50 |
| M27222206 | 22 x 22 x 3/4" | 2 | 40 |

Compression Fittings: Stop End



| MasterFlow Code | Size (mm) | Bag Qty | Box Qty |
|-----------------|-----------|---------|---------|
| M15080000 | 8 | 2 | 300 |
| M15100000 | 10 | 10 | 300 |
| M15150000 | 15 | 10 | 300 |
| M15220000 | 22 | 10 | 200 |
| M15280000 | 28 | 2 | 150 |
| M15350000 | 35 | 2 | 100 |
| M15420000 | 42 | 2 | 50 |
| M15540000 | 54 | 2 | 40 |

Compression Fittings: Bent Tap Connector



| MasterFlow Code | Size (mm) | Bag Qty | Box Qty |
|-----------------|-----------|---------|---------|
| M24150400 | 15 x 1/2" | 2 | 150 |
| M24220600 | 22 x 3/4" | 2 | 100 |

Compression Fittings: Straight Tap Connector



| MasterFlow Code | Size (mm) | Bag Qty | Box Qty |
|-----------------|-----------|---------|---------|
| M13150400 | 15 x 1/2" | 2 | 200 |
| M13150600 | 15 x 3/4" | 2 | 150 |
| M13220600 | 22 x 3/4" | 2 | 100 |

Compression Fittings: Flanged Tank Connector



| MasterFlow Code | Size (mm) | Bag Qty | Box Qty |
|-----------------|-----------|---------|---------|
| M14150000 | 15 | 2 | 150 |
| M14220000 | 22 | 2 | 100 |
| M14280000 | 28 | 2 | 50 |
| M14350000 | 35 | 2 | 24 |
| M14420000 | 42 | 2 | 20 |
| M14540000 | 54 | 2 | 14 |

Compression Fittings: Compression Nut



| MasterFlow Code | Size (mm) | Bag Qty | Box Qty |
|-----------------|-----------|---------|---------|
| M22150000 | 15 | 10 | 500 |
| M22220000 | 22 | 10 | 400 |
| M22280000 | 28 | 2 | 300 |

Compression Fittings: Blank Disc



| MasterFlow Code | Size (mm) | Bag Qty | Box Qty |
|-----------------|-----------|---------|---------|
| MBD15 | 15 | 10 | 500 |
| MBD22 | 22 | 2 | 400 |
| MBD28 | 28 | 2 | 200 |

DZR Compression Fittings

- WRAS approved.
- Marked for full traceability.
- Supported by full manufacturer's warranty.
- Compliant with relevant British standards - EN1254/BS864.
- Manufactured using high quality DZR brass material.



DZR Compression Fittings: Straight Coupler



| MasterFlow Code | Size (mm) | Bag Qty | Box Qty |
|-----------------|-----------|---------|---------|
| M1008000DZR | 8 | 2 | 250 |
| M1010000DZR | 10 | 10 | 250 |
| M1015000DZR | 15 | 10 | 200 |
| M1022000DZR | 22 | 10 | 100 |
| M1028000DZR | 28 | 10 | 50 |
| M1035000DZR | 35 | 2 | 40 |
| M1042000DZR | 42 | 2 | 30 |
| M1054000DZR | 54 | 2 | 20 |

DZR Compression Fittings: Reduced Coupler



| MasterFlow Code | Size (mm) | Bag Qty | Box Qty |
|-----------------|-----------|---------|---------|
| M10100800DZR | 10 x 8 | 2 | 250 |
| M10150800DZR | 15 x 8 | 2 | 250 |
| M10151000DZR | 15 x 10 | 2 | 250 |
| M10221500DZR | 22 x 15 | 5 | 150 |
| M10281500DZR | 28 x 15 | 5 | 100 |
| M10282200DZR | 28 x 22 | 5 | 100 |

DZR Compression Fittings: Repair Coupler

| MasterFlow Code | Size (mm) | Bag Qty | Box Qty |
|-----------------|-----------|---------|---------|
| M10159650DZR | 15 | 2 | 100 |
| M10228000DZR | 22 | 2 | 50 |



DZR Compression Fittings: C x FI Straight Coupler

| MasterFlow Code | Size (mm) | Bag Qty | Box Qty |
|-----------------|-------------|---------|---------|
| M12080200DZR | 8 x 1/4" | 2 | 250 |
| M12080300DZR | 8 x 3/8" | 2 | 200 |
| M12100200DZR | 10 x 1/4" | 2 | 300 |
| M12100300DZR | 10 x 3/8" | 2 | 300 |
| M12100400DZR | 10 x 1/2" | 2 | 250 |
| M12120300DZR | 12 x 3/8" | 2 | 250 |
| M12120400DZR | 12 x 1/2" | 2 | 250 |
| M12150200DZR | 15 x 1/4" | 2 | 200 |
| M12150300DZR | 15 x 3/8" | 2 | 200 |
| M12150400DZR | 15 x 1/2" | 10 | 200 |
| M12150600DZR | 15 x 3/4" | 5 | 200 |
| M12220400DZR | 22 x 1/2" | 2 | 150 |
| M12220600DZR | 22 x 3/4" | 2 | 150 |
| M12220800DZR | 22 x 1" | 2 | 100 |
| M12280800DZR | 28 x 1" | 2 | 100 |
| M12351000DZR | 35 x 1.1/4" | 2 | 30 |
| M12421200DZR | 42 x 1.1/2" | 2 | 20 |
| M12541600DZR | 54 x 2" | 2 | 20 |



DZR Compression Fittings: C x FI Elbow

| MasterFlow Code | Size (mm) | Bag Qty | Box Qty |
|-----------------|-----------|---------|---------|
| M18150400DZR | 15 x 1/2" | 5 | 150 |
| M18150600DZR | 15 x 3/4" | 5 | 100 |
| M18220600DZR | 22 x 3/4" | 5 | 100 |
| M18220800DZR | 22 x 1" | 5 | 100 |
| M18280800DZR | 28 x 1" | 2 | 50 |



DZR Compression Fittings: C x MI Straight Coupler



| MasterFlow Code | Size (mm) | Bag Qty | Box Qty |
|-----------------|-------------|---------|---------|
| M11080200DZR | 8 x 1/4" | 2 | 300 |
| M11080300DZR | 8 x 3/8" | 2 | 250 |
| M11080400DZR | 8 x 1/2" | 2 | 250 |
| M11100200DZR | 10 x 1/4" | 2 | 300 |
| M11100300DZR | 10 x 3/8" | 2 | 300 |
| M11100400DZR | 10 x 1/2" | 2 | 250 |
| M11150200DZR | 15 x 1/4" | 2 | 200 |
| M11150300DZR | 15 x 3/8" | 2 | 200 |
| M11150400DZR | 15 x 1/2" | 10 | 200 |
| M11150600DZR | 15 x 3/4" | 5 | 200 |
| M11220400DZR | 22 x 1/2" | 2 | 150 |
| M11220600DZR | 22 x 3/4" | 2 | 150 |
| M11220800DZR | 22 x 1" | 2 | 100 |
| M11280800DZR | 28 x 1" | 2 | 100 |
| M11351000DZR | 35 x 1.1/4" | 2 | 30 |
| M11421200DZR | 42 x 1.1/2" | 2 | 20 |
| M11541600DZR | 54 x 2" | 2 | 10 |

DZR Compression Fittings: C x MI Elbow



| MasterFlow Code | Size (mm) | Bag Qty | Box Qty |
|-------------------------------|-----------|---------|---------|
| M17150400DZR | 15 x 1/2" | 5 | 150 |
| M17150600DZR | 15 x 3/4" | 5 | 100 |
| M17220600DZR | 22 x 3/4" | 5 | 100 |
| M17220600DODZR (c/w drainoff) | 22 x 3/4" | 2 | 50 |
| M17220800DZR | 22 x 1" | 5 | 100 |
| M17280800DZR | 28 x 1" | 2 | 50 |

DZR Compression Fittings: 90deg. Elbow



| MasterFlow Code | Size (mm) | Bag Qty | Box Qty |
|-----------------|-----------|---------|---------|
| M16080000DZR | 8 | 10 | 500 |
| M16100000DZR | 10 | 10 | 250 |
| M16150000DZR | 15 | 10 | 200 |
| M16220000DZR | 22 | 10 | 100 |
| M16280000DZR | 28 | 5 | 50 |
| M16350000DZR | 35 | 2 | 40 |
| M16420000DZR | 42 | 2 | 26 |
| M16540000DZR | 54 | 2 | 10 |

DZR Compression Fittings: Wallplate Elbow



| MasterFlow Code | Size (mm) | Bag Qty | Box Qty |
|-----------------|-----------|---------|---------|
| M19150400DZR | 15 x 1/2" | 2 | 100 |
| M19220600DZR | 22 x 3/4" | 2 | 50 |

DZR Compression Fittings: Equal Tee



| MasterFlow Code | Size (mm) | Bag Qty | Box Qty |
|-----------------|-----------|---------|---------|
| M20100000DZR | 10 | 10 | 200 |
| M20150000DZR | 15 | 10 | 100 |
| M20220000DZR | 22 | 10 | 50 |
| M20280000DZR | 28 | 2 | 40 |
| M20350000DZR | 35 | 2 | 26 |
| M20420000DZR | 42 | 2 | 16 |
| M20540000DZR | 54 | 2 | 10 |

DZR Compression Fittings: Reducing Tee



| MasterFlow Code | Size (mm) | Bag Qty | Box Qty |
|-----------------|--------------|---------|---------|
| M20151510DZR | 15 x 15 x 10 | 2 | 100 |
| M20151522DZR | 15 x 15 x 22 | 2 | 100 |
| M20221515DZR | 22 x 15 x 15 | 2 | 50 |
| M20221522DZR | 22 x 15 x 22 | 2 | 50 |
| M2022215DZR | 22 x 22 x 15 | 2 | 50 |
| M20281528DZR | 28 x 15 x 28 | 2 | 40 |
| M20282222DZR | 28 x 22 x 22 | 2 | 40 |
| M20282228DZR | 28 x 22 x 28 | 2 | 40 |
| M20282822DZR | 28 x 28 x 22 | 2 | 40 |

DZR Compression Fittings: C x C x FI Reducing Tee



| MasterFlow Code | Size (mm) | Bag Qty | Box Qty |
|-----------------|----------------|---------|---------|
| M27151504DZR | 15 x 15 x 1/2" | 2 | 100 |
| M27150415DZR | 15 x 1/2" x 15 | 2 | 50 |
| M27222204DZR | 22 x 22 x 1/2" | 2 | 50 |
| M27222206DZR | 22 x 22 x 3/4" | 2 | 50 |

DZR Compression Fittings: Stop End



| MasterFlow Code | Size (mm) | Bag Qty | Box Qty |
|-----------------|-----------|---------|---------|
| M1508000DZR | 8 | 10 | 500 |
| M1510000DZR | 10 | 10 | 500 |
| M1515000DZR | 15 | 10 | 300 |
| M1522000DZR | 22 | 10 | 200 |
| M1528000DZR | 28 | 2 | 150 |
| M1535000DZR | 35 | 2 | 100 |
| M1542000DZR | 42 | 2 | 50 |
| M1554000DZR | 54 | 2 | 40 |

DZR Compression Fittings: Bent Tap Connector



| MasterFlow Code | Size (mm) | Bag Qty | Box Qty |
|-----------------|-----------|---------|---------|
| M24150400DZR | 15 x 1/2" | 2 | 150 |
| M24220600DZR | 22 x 3/4" | 2 | 100 |

DZR Compression Fittings: Straight Tap Connector



| MasterFlow Code | Size (mm) | Bag Qty | Box Qty |
|-----------------|-----------|---------|---------|
| M13150400DZR | 15 x 1/2" | 2 | 200 |
| M13150600DZR | 15 x 3/4" | 2 | 150 |
| M13220600DZR | 22 x 3/4" | 2 | 100 |

DZR Compression Fittings: Flanged Tank Connector



| MasterFlow Code | Size (mm) | Bag Qty | Box Qty |
|-----------------|-----------|---------|---------|
| M14150000DZR | 15 | 2 | 150 |
| M14220000DZR | 22 | 2 | 100 |
| M14280000DZR | 28 | 2 | 50 |
| M14350000DZR | 35 | 2 | 24 |
| M14420000DZR | 42 | 2 | 20 |
| M14540000DZR | 54 | 2 | 14 |

Chrome Plated Compression Fittings

- WRAS approved.
- Marked for full traceability.
- Supported by full manufacturer's warranty.
- Compliant with relevant British standards – EN1254.
- Manufactured using high quality brass and chrome plated material.



Chrome Plated Compression Fittings: Straight Coupler

| MasterFlow Code | Size (mm) | Bag Qty | Box Qty |
|-----------------|-----------|---------|---------|
| M10150000P | 15 | 5 | 200 |
| M10220000P | 22 | 5 | 100 |
| M10280000P | 28 | 2 | 50 |
| M10350000P | 35 | 2 | 40 |
| M10420000P | 42 | 2 | 30 |
| M10540000P | 54 | 2 | 20 |



Chrome Plated Compression Fittings: C x FI Straight Coupler

| MasterFlow Code | Size (mm) | Bag Qty | Box Qty |
|-----------------|-----------|---------|---------|
| M12150400P | 15 x 1/2" | 2 | 200 |
| M12220600P | 22 x 3/4" | 2 | 150 |
| M12280800P | 28 x 1" | 2 | 80 |



Chrome Plated Compression Fittings: C x MI Straight Coupler



| MasterFlow Code | Size (mm) | Bag Qty | Box Qty |
|-----------------|-------------|---------|---------|
| M11150400P | 15 x 1/2" | 2 | 200 |
| M11220600P | 22 x 3/4" | 2 | 150 |
| M11220800P | 22 x 1" | 2 | 150 |
| M11280800P | 28 x 1" | 2 | 100 |
| M11351000P | 35 x 1.1/4" | 2 | 30 |

Chrome Plated Compression Fittings: C x FI Elbow



| MasterFlow Code | Size (mm) | Bag Qty | Box Qty |
|-----------------|-----------|---------|---------|
| M18150400P | 15 x 1/2" | 2 | 150 |

Chrome Plated Compression Fittings: C x MI Elbow



| MasterFlow Code | Size (mm) | Bag Qty | Box Qty |
|-----------------|-----------|---------|---------|
| M17150400P | 15 x 1/2" | 2 | 150 |

Chrome Plated Compression Fittings: 90deg. Elbow



| MasterFlow Code | Size (mm) | Bag Qty | Box Qty |
|-----------------|-----------|---------|---------|
| M16150000P | 15 | 5 | 200 |
| M16220000P | 22 | 5 | 100 |
| M16280000P | 28 | 2 | 50 |
| M16350000P | 35 | 2 | 40 |
| M16420000P | 42 | 2 | 24 |
| M16540000P | 54 | 2 | 10 |

Chrome Plated Compression Fittings: Wallplate Elbow



| MasterFlow Code | Size (mm) | Bag Qty | Box Qty |
|-----------------|-----------|---------|---------|
| M19150400P | 15 x 1/2" | 2 | 100 |

Chrome Plated Compression Fittings: Equal Tee



| MasterFlow Code | Size (mm) | Bag Qty | Box Qty |
|-----------------|-----------|---------|---------|
| M20150000P | 15 | 5 | 100 |
| M20220000P | 22 | 5 | 50 |
| M20280000P | 28 | 2 | 40 |
| M20350000P | 35 | 2 | 26 |
| M20420000P | 42 | 2 | 14 |
| M20540000P | 54 | 2 | 10 |

Chrome Plated Compression Fittings: Reducing Tee



| MasterFlow Code | Size (mm) A x B x C | Bag Qty | Box Qty |
|-----------------|---------------------|---------|---------|
| M20222215P | 22 x 22 x 15 | 2 | 50 |

Chrome Plated Compression Fittings: Stop End



| MasterFlow Code | Size (mm) | Bag Qty | Box Qty |
|-----------------|-----------|---------|---------|
| M15150000P | 15 | 2 | 300 |
| M15220000P | 22 | 2 | 200 |

Copper Pushfit Fittings

- WRAS approved.
- Marked for full traceability.
- Supported by full manufacturer's warranty.
- Compliant with relevant British standards – EN1254/BS864.
- Manufactured using high quality copper material in accordance with EN1254-2.



Copper Pushfit Fittings: Straight Coupler



| MasterFlow Code | Size (mm) | Bag Qty | Box Qty |
|-----------------|-----------|---------|---------|
| MPFR10100000 | 10 | 5 | 100 |
| MPFS10150000 | 15 | 5 | 100 |
| MPFS10220000 | 22 | 5 | 50 |
| MPFR10280000 | 28 | 1 | 20 |

Copper Pushfit Fittings: Elbow

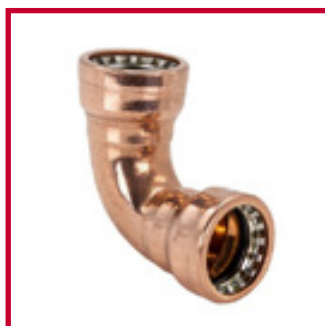

| MasterFlow Code | Size (mm) | Bag Qty | Box Qty |
|-----------------|-----------|---------|---------|
| MPFR16100000 | 10 | 5 | 100 |
| MPFS16150000 | 15 | 5 | 75 |
| MPFS16220000 | 22 | 5 | 40 |
| MPFR16280000 | 28 | 1 | 10 |

Copper Pushfit Fittings: Female Wall Plate

| MasterFlow Code | Size (mm) | Bag Qty | Box Qty |
|-----------------|-----------|---------|---------|
| MPFR19150400 | 15 x 1/2" | 5 | 50 |



Copper Pushfit Fittings: Tee - Equal

| MasterFlow Code | Size (mm) | Bag Qty | Box Qty |
|-----------------|-----------|---------|---------|
| MPFR20100000 | 10 | 5 | 100 |
| MPFS20150000 | 15 | 5 | 50 |
| MPFS20220000 | 22 | 5 | 25 |
| MPFR20280000 | 28 | 1 | 10 |



Copper Pushfit Fittings: Tee - Reduced Branch

| MasterFlow Code | Size (mm) A x B x C | Bag Qty | Box Qty |
|-----------------|---------------------|---------|---------|
| MPFS20222215 | 22 x 22 x 15 | 5 | 25 |
| MPFR20282822 | 28 x 28 x 22 | 1 | 10 |



Copper Pushfit Fittings: Tee - Reduced End

| MasterFlow Code | Size (mm) A x B x C | Bag Qty | Box Qty |
|-----------------|---------------------|---------|---------|
| MPFR20221522 | 22 x 15 x 22 | 5 | 50 |



Copper Pushfit Fittings: Tee - Reduced End & Branch



| MasterFlow Code | Size (mm) A x B x C | Bag Qty | Box Qty |
|-----------------|---------------------|---------|---------|
| MPFR20221515 | 22 x 15 x 15 | 5 | 25 |

Copper Pushfit Fittings: Fitting Reducer



| MasterFlow Code | Size (mm) | Bag Qty | Box Qty |
|-----------------|-----------|---------|---------|
| MPFR92151000 | 15 x 10 | 5 | 100 |
| MPFR92221500 | 22 x 15 | 5 | 100 |
| MPFR92282200 | 28 x 22 | 1 | 20 |

Copper Pushfit Fittings: Straight Tap Connector



| MasterFlow Code | Size (mm) | Bag Qty | Box Qty |
|-----------------|-----------|---------|---------|
| MPFR13150400 | 15 x 1/2" | 1 | 50 |
| MPFR13220600 | 22 x 3/4" | 5 | 50 |

Copper Pushfit Fittings: Bent Tap Connector



| MasterFlow Code | Size (mm) | Bag Qty | Box Qty |
|-----------------|-----------|---------|---------|
| MPFR24150400 | 15 x 1/2" | 5 | 100 |

Copper Pushfit Fittings: Stop End



| MasterFlow Code | Size (mm) | Bag Qty | Box Qty |
|-----------------|-----------|---------|---------|
| MPFR15100000 | 10 | 5 | 100 |
| MPFS15150000 | 15 | 5 | 100 |
| MPFS15220000 | 22 | 5 | 75 |
| MPFR15280000 | 28 | 1 | 20 |

Copper Pushfit Fittings: Blanking Plug

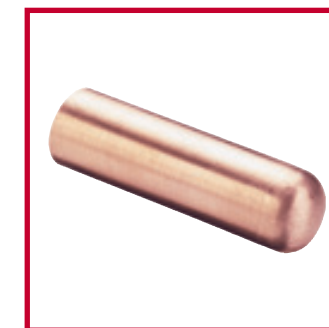

| MasterFlow Code | Size (mm) | Bag Qty | Box Qty |
|-----------------|-----------|---------|---------|
| MPFRBP1500 | 15 | 5 | 150 |

Copper Pushfit Fittings: Male Straight Connector



| MasterFlow Code | Size (mm) | Bag Qty | Box Qty |
|-----------------|-------------|---------|---------|
| MPFR11150400 | 15 x 1/2" | 5 | 100 |
| MPFR11220600 | 22 x 3/4" | 5 | 50 |
| MPFR11280800 | 28 x 1" | 1 | 20 |
| MPFR11281000 | 28 x 1.1/4" | 1 | 20 |

Copper Pushfit Fittings: Female Straight Connector

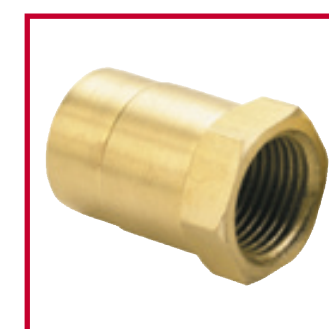

| MasterFlow Code | Size (mm) | Bag Qty | Box Qty |
|-----------------|-------------|---------|---------|
| MPFR12150400 | 15 x 1/2" | 5 | 100 |
| MPFR12220600 | 22 x 3/4" | 5 | 50 |
| MPFR12280800 | 28 x 1" | 1 | 20 |
| MPFR12281000 | 28 x 1.1/4" | 1 | 20 |

Copper Pushfit Fittings: Male Plain Tail Adaptor



| MasterFlow Code | Size (mm) | Bag Qty | Box Qty |
|-----------------|-----------|---------|---------|
| MPFN208G220600 | 22 x 3/4" | 5 | 50 |

Copper Pushfit Fittings: Tank Connector



| MasterFlow Code | Size (mm) | Bag Qty | Box Qty |
|-----------------|-----------|---------|---------|
| MPFR29150600 | 22 x 3/4" | 5 | 25 |

Copper Pushfit Fittings: Telescopic Connector - Double



| MasterFlow Code | Size (mm) | Bag Qty | Box Qty |
|-----------------|-----------|---------|---------|
| MPFNTC1500D | 15 | 1 | 6 |
| MPFNTC2200D | 22 | 1 | 6 |

Copper Pushfit Fittings: Telescopic Connector - Single



| MasterFlow Code | Size (mm) | Bag Qty | Box Qty |
|-----------------|-----------|---------|---------|
| MPFNTC1500S | 15 | 1 | 6 |
| MPFNTC2200S | 22 | 1 | 6 |
| MPFNTC2800S | 28 | 1 | 5 |

Copper Pushfit Fittings: Drain Off Cock - Type A



| MasterFlow Code | Size (mm) | Bag Qty | Box Qty |
|-----------------|-----------|---------|---------|
| MPFNDA1500 | 15 | 10 | 100 |

Copper Pushfit Fittings: Isolating Valve



| MasterFlow Code | Size (mm) | Bag Qty | Box Qty |
|-----------------|-----------|---------|---------|
| MPFR281500 | 15 | 2 | 50 |

Copper Pushfit Fittings: Straight Washing Machine Valve

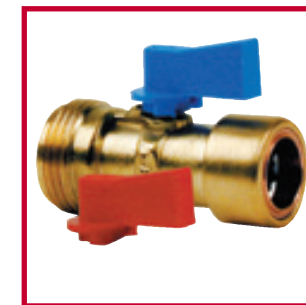

| MasterFlow Code | Size (mm) | Bag Qty | Box Qty |
|-----------------|-----------|---------|---------|
| MPFRWM1506 | 15 x 3/4" | 1 | 50 |

Copper Pushfit Fittings: Lever Ball Valve



| MasterFlow Code | Size (mm) | Bag Qty | Box Qty |
|-----------------|-----------|---------|---------|
| MPFR692200 | 22 | 1 | 10 |

Copper Pushfit Fittings: Release Tool



| MasterFlow Code | Size (mm) A x B x C | Bag Qty | Box Qty |
|-----------------|---------------------|---------|---------|
| MPFRRT | 22 x 15 x 10 | 1 | 25 |

Yellow Brass

- WRAS Approved (where applicable*).
- Marked for full traceability.
- Supported by full manufacturer's warranty.
- Compliant with relevant British standards.
- Manufactured using high quality brass material.

*See website for further details



Yellow Brass Fittings: Poly Shank Adaptor



| MasterFlow Code | Size (mm) | Bag Qty | Box Qty |
|-----------------|-----------|---------|---------|
| MPSA2015 | 20 x 15 | 1 | 50 |
| MPSA2022 | 20 x 22 | 1 | 50 |
| MPSA2515 | 25 x 15 | 1 | 50 |
| MPSA2522 | 25 x 22 | 1 | 50 |

Yellow Brass Fittings: Brass Blank Nut



| MasterFlow Code | Size (mm) | Bag Qty | Box Qty |
|-----------------|-----------|---------|---------|
| M25020000 | 1/4" | 5 | 500 |
| M25030000 | 3/8" | 5 | 500 |
| M25040000 | 1/2" | 10 | 350 |
| M25060000 | 3/4" | 10 | 250 |
| M25080000 | 1" | 2 | 100 |
| M25100000 | 1.1/4" | 2 | 100 |
| M25120000 | 1.1/2" | 2 | 50 |
| M25160000 | 2" | 1 | 50 |

Yellow Brass Fittings: Copper Olives

| MasterFlow Code | Size (mm) | Bag Qty | Box Qty |
|-----------------|-----------|---------|---------|
| M23080000C | 8 | 10 | 2500 |
| M23100000C | 10 | 10 | 2500 |
| M23120000C | 12 | 10 | 2000 |
| M23150000C | 15 | 10 | 2000 |
| M23200000C | 20 | 10 | 1000 |
| M23220000C | 22 | 10 | 1000 |
| M23250000C | 25 | 10 | 500 |
| M23280000C | 28 | 10 | 500 |
| M23060000C | 3/4" | 10 | 500 |



Yellow Brass Fittings: Brass Olives

| MasterFlow Code | Size (mm) | Bag Qty | Box Qty |
|-----------------|-----------|---------|---------|
| M23080000 | 8 | 10 | 2500 |
| M23100000 | 10 | 10 | 2500 |
| M23120000 | 12 | 10 | 2000 |
| M23150000 | 15 | 10 | 2000 |
| M23200000 | 20 | 10 | 1000 |
| M23220000 | 22 | 10 | 1000 |
| M23250000 | 25 | 10 | 500 |
| M23280000 | 28 | 10 | 500 |
| M23060000 | 3/4" | 10 | 500 |
| M23350000 | 35 | 50 | 500 |
| M23420000 | 42 | 20 | 200 |
| M23540000 | 54 | 15 | 150 |



Yellow Brass Fittings: 3 Part Reducing Set



| MasterFlow Code | Size (mm) | Bag Qty | Box Qty |
|-----------------|-----------|---------|---------|
| M3RS1008 | 10 x 8 | 10 | 500 |
| M3RS1508 | 15 x 8 | 5 | 500 |
| M3RS1510 | 15 x 10 | 5 | 500 |
| M3RS1512 | 15 x 12 | 5 | 250 |
| M3RS2215 | 22 x 15 | 5 | 250 |
| M3RS2815 | 28 x 15 | 5 | 250 |
| M3RS2822 | 28 x 22 | 5 | 250 |
| M3RS3515 | 35 x 15 | 5 | 150 |
| M3RS3522 | 35 x 22 | 5 | 100 |
| M3RS3528 | 35 x 28 | 5 | 100 |
| M3RS4215 | 42 x 15 | 2 | 100 |
| M3RS4222 | 42 x 22 | 2 | 100 |
| M3RS4235 | 42 x 35 | 2 | 100 |
| M3RS5415 | 54 X 15 | 1 | 100 |
| M3RS5422 | 54 x 22 | 1 | 100 |
| M3RS5428 | 54 x 28 | 1 | 70 |
| M3RS5435 | 54 x 35 | 1 | 70 |
| M3RS5442 | 54 x 42 | 1 | 70 |

Yellow Brass Fittings: Lead Loc



| MasterFlow Code | Size (mm) | Bag Qty | Box Qty |
|-----------------|-----------------|---------|---------|
| MLL03515 | 15 x 3/8" x 5lb | 1 | 50 |
| MLL04615 | 15 x 1/2" x 6lb | 1 | 50 |
| MLL04715 | 15 x 1/2" x 7lb | 1 | 50 |
| MLL06922 | 22 x 3/4" x 9lb | 1 | 50 |

Yellow Brass Fittings: Brass Bush



| MasterFlow Code | Size (mm) | Bag Qty | Box Qty |
|-----------------|----------------|---------|---------|
| MBB020100 | 1/4" x 1/8" | 5 | 500 |
| MBB030100 | 3/8" x 1/8" | 5 | 500 |
| MBB030200 | 3/8" x 1/4" | 5 | 500 |
| MBB040100 | 1/2" x 1/8" | 5 | 500 |
| MBB040200 | 1/2" x 1/4" | 5 | 500 |
| MBB040200T | 1/2" x 1/4" | 5 | 500 |
| MBB040300 | 1/2" x 3/8" | 5 | 500 |
| MBB060200 | 3/4" x 1/4" | 5 | 250 |
| MBB060300 | 3/4" x 3/8" | 5 | 250 |
| MBB060400 | 3/4" x 1/2" | 5 | 250 |
| MBB080400 | 1 x 1/2" | 5 | 200 |
| MBB080600 | 1 x 3/4" | 5 | 200 |
| MBB100400 | 1.1/4 x 1/2" | 2 | 100 |
| MBB100600 | 1.1/4 x 3/4" | 2 | 100 |
| MBB100800 | 1.1/4 x 1" | 2 | 100 |
| MBB120400 | 1.1/2 x 1/2" | 2 | 50 |
| MBB120600 | 1.1/2 x 3/4" | 2 | 50 |
| MBB120800 | 1.1/2 x 1" | 2 | 50 |
| MBB121000 | 1.1/2 x 1.1/4" | 2 | 50 |
| MBB160400 | 2 x 1/2" | 2 | 24 |
| MBB160600 | 2 x 3/4" | 2 | 24 |
| MBB160800 | 2 x 1" | 2 | 24 |
| MBB161000 | 2 x 1.1/4" | 2 | 24 |
| MBB161200 | 2 x 1.1/2" | 2 | 24 |

Yellow Brass Fittings: Running Nipple



| MasterFlow Code | Size (mm) | Bag Qty | Box Qty |
|-----------------|-----------|---------|---------|
| MBRN02 | 1/4" | 5 | 500 |
| MBRN03 | 3/8" | 5 | 500 |
| MBRN04 | 1/2" | 5 | 250 |
| MBRN06 | 3/4" | 2 | 200 |
| MBRN08 | 1" | 2 | 100 |
| MBRN10 | 1.1/4" | 2 | 50 |
| MBRN12 | 1.1/2" | 2 | 24 |
| MBRN16 | 2" | 2 | 24 |

Yellow Brass Fittings: Hexagon Nipple



| MasterFlow Code | Size (mm) | Bag Qty | Box Qty |
|------------------|-----------|---------|---------|
| MBHN01 | 1/8" | 5 | 500 |
| MBHN02 | 1/4" | 5 | 500 |
| MBHN03 | 3/8" | 5 | 500 |
| MBHN04 | 1/2" | 5 | 250 |
| MBHN04P (Chrome) | 1/2" | 5 | 250 |
| MBHN06 | 3/4" | 5 | 200 |
| MBHN08 | 1" | 5 | 100 |
| MBHN10 | 1.1/4" | 2 | 50 |
| MBHN12 | 1.1/2" | 2 | 24 |
| MBHN16 | 2" | 2 | 24 |

Yellow Brass Fittings: Reducing Hexagon Nipple



| MasterFlow Code | Size (mm) | Bag Qty | Box Qty |
|-----------------|----------------|---------|---------|
| MBRHN0201 | 1/4 x 1/8" | 5 | 500 |
| MBRHN0301 | 3/8 x 1/8" | 5 | 500 |
| MBRHN0302 | 3/8" x 1/4" | 5 | 500 |
| MBRHN0401 | 1/2" x 1/8" | 5 | 250 |
| MBRHN0402 | 1/2" x 1/4" | 5 | 250 |
| MBRHN0403 | 1/2" x 3/8" | 5 | 250 |
| MBRHN0604 | 3/4 x 1/2" | 2 | 200 |
| MBRHN0804 | 1 x 1/2" | 2 | 200 |
| MBRHN0806 | 1 x 3/4" | 2 | 100 |
| MBRHN1006 | 1.1/4 x 3/4" | 5 | 100 |
| MBRHN1008 | 1.1/4 x 1" | 5 | 50 |
| MBRHN1208 | 1.1/2 x 1" | 5 | 50 |
| MBRHN1210 | 1.1/2 x 1.1/4" | 5 | 50 |
| MBRHN1608 | 2 x 1" | 2 | 24 |
| MBRHN1610 | 2 x 1.1/4" | 2 | 24 |
| MBRHN1612 | 2 x 1.1/2" | 2 | 24 |

Yellow Brass Fittings: Barrel Nipple



| MasterFlow Code | Size (mm) | Bag Qty | Box Qty |
|-----------------|-----------|---------|---------|
| MBBN01 | 1/8" | 5 | 500 |
| MBBN02 | 1/4" | 5 | 500 |
| MBBN03 | 3/8" | 5 | 500 |
| MBBN04 | 1/2" | 5 | 250 |
| MBBN06 | 3/4" | 5 | 250 |
| MBBN08 | 1" | 2 | 100 |
| MBBN10 | 1.1/4" | 2 | 50 |
| MBBN12 | 1.1/2" | 2 | 24 |
| MBBN16 | 2" | 2 | 24 |

Yellow Brass Fittings: Flanged Plug



| MasterFlow Code | Size (mm) | Bag Qty | Box Qty |
|-----------------|-----------|---------|---------|
| MBFP01 | 1/8" | 5 | 500 |
| MBFP02 | 1/4" | 5 | 500 |
| MBFP03 | 3/8" | 5 | 500 |
| MBFP04 | 1/2" | 5 | 250 |
| MBFP06 | 3/4" | 5 | 250 |
| MBFP08 | 1" | 5 | 100 |
| MBFP10 | 1.1/4" | 2 | 100 |
| MBFP12 | 1.1/2" | 2 | 50 |
| MBFP16 | 2" | 2 | 24 |

Yellow Brass Fittings: F x F Brass Sockets



| MasterFlow Code | Size (mm) | Bag Qty | Box Qty |
|-----------------|-----------|---------|---------|
| MBS02 | 1/4" | 5 | 500 |
| MBS03 | 3/8" | 5 | 500 |
| MBS04 | 1/2" | 5 | 250 |
| MBS06 | 3/4" | 5 | 200 |
| MBS08 | 1" | 5 | 100 |
| MBS10 | 1.1/4" | 2 | 50 |
| MBS12 | 1.1/2" | 2 | 24 |
| MBS16 | 2" | 2 | 24 |

Yellow Brass Fittings: Spacer Nipple



| MasterFlow Code | Size (mm) | Bag Qty | Box Qty |
|-----------------|-----------|---------|---------|
| MBSN01 | 1/8" | 5 | 500 |
| MBSN02 | 1/4" | 5 | 500 |
| MBSN03 | 3/8" | 5 | 500 |
| MBSN04 | 1/2" | 5 | 250 |
| MBSN06 | 3/4" | 5 | 250 |
| MBSN08 | 1" | 5 | 100 |
| MBSN10 | 1.1/4" | 2 | 50 |
| MBSN12 | 1.1/2" | 2 | 24 |
| MBSN16 | 2" | 2 | 24 |

Yellow Brass Fittings: BSP Wide Flanged Backnuts



| MasterFlow Code | Size (mm) | Bag Qty | Box Qty |
|-----------------|-----------|---------|---------|
| MWFB04 | 1/2" | 5 | 250 |
| MWFB06 | 3/4" | 5 | 250 |
| MWFB08 | 1" | 5 | 200 |
| MWFB10 | 1.1/4" | 2 | 100 |
| MWFB12 | 1.1/2" | 2 | 100 |

Yellow Brass Fittings: Stopcock F x F



| MasterFlow Code | Size (mm) | Bag Qty | Box Qty |
|-----------------|-----------|---------|---------|
| M34040000 | 1/2" | 1 | 50 |
| M34060000 | 3/4" | 1 | 25 |
| M34080000 | 1" | 1 | 20 |
| M34100000 | 1.1/4" | 1 | 10 |
| M34120000 | 1.1/2" | 1 | 5 |
| M34160000 | 2" | 1 | 5 |

Yellow Brass: Stopcock BS1010 C x C



| MasterFlow Code | Size (mm) | Bag Qty | Box Qty |
|-----------------|-----------|---------|---------|
| M34150000 | 15 | 1 | 50 |
| M34220000 | 22 | 1 | 25 |
| M34280000 | 28 | 1 | 20 |
| M34350000 | 35 | 1 | 8 |
| M34420000 | 42 | 1 | 6 |
| M34540000 | 54 | 1 | 4 |

DZR: Stopcock C x C

| MasterFlow Code | Size (mm) | Bag Qty | Box Qty |
|-----------------|-----------|---------|---------|
| M34150000DZR | 15 | 1 | 50 |
| M34220000DZR | 22 | 1 | 25 |
| M34280000DZR | 28 | 1 | 20 |



DZR: DZR Poly Stopcock

| MasterFlow Code | Size (mm) | Bag Qty | Box Qty |
|-----------------|-----------|---------|---------|
| M35222500DZR | 22 x 25 | 1 | 25 |



Yellow Brass: Brass Poly Stopcock

| MasterFlow Code | Size (mm) | Bag Qty | Box Qty |
|-----------------|-----------|---------|---------|
| M35152000 | 15 x 20 | 1 | 40 |
| M35200000 | 20 x 20 | 1 | 40 |
| M35152500 | 15 x 25 | 1 | 25 |
| M35222500 | 22 x 25 | 1 | 25 |
| M35250000 | 25 x 25 | 1 | 25 |



Yellow Brass: Gatevalve C x C

| MasterFlow Code | Size (mm) | Bag Qty | Box Qty |
|-----------------|-----------|---------|---------|
| M33150000LP | 15 | 1 | 60 |
| M33220000LP | 22 | 1 | 40 |
| M33280000LP | 28 | 1 | 30 |



Brass PN16: Gatevalve C x C BS



| MasterFlow Code | Size (mm) | Bag Qty | Box Qty |
|-----------------|-----------|---------|---------|
| M33150000* | 15 | 1 | 54 |
| M33220000* | 22 | 1 | 32 |
| M33280000* | 28 | 1 | 21 |
| M33350000 | 35 | 1 | 10 |
| M33420000 | 42 | 1 | 8 |
| M33540000 | 54 | 1 | 6 |

Yellow Brass: Gatevalve F x F



| MasterFlow Code | Size (mm) | Bag Qty | Box Qty |
|-----------------|-----------|---------|---------|
| M33030000 | 3/8" | 1 | 50 |
| M33040000 | 1/2" | 1 | 50 |
| M33060000 | 3/4" | 1 | 25 |
| M33080000 | 1" | 1 | 20 |
| M33100000 | 1.1/4" | 1 | 10 |
| M33120000 | 1.1/2" | 1 | 10 |
| M33160000 | 2" | 1 | 5 |

Yellow Brass: Lockshield Gatevalve C x C



| MasterFlow Code | Size (mm) | Bag Qty | Box Qty |
|-----------------|-----------|---------|---------|
| M33150000LPLK | 15 | 1 | 50 |
| M33220000LPLK | 22 | 1 | 50 |
| M33280000LPLK | 28 | 1 | 40 |

Yellow Brass: Type A Drain Off Cock



| MasterFlow Code | Size (mm) | Bag Qty | Box Qty |
|-----------------|-----------|---------|---------|
| MDA04 | 1/2" | 1 | 200 |
| MDA06 | 3/4" | 1 | 100 |
| MDA04DZR | 1/2" | 1 | 200 |

Yellow Brass: Type A Drain Off Cock - Capillary

| MasterFlow Code | Size (mm) | Bag Qty | Box Qty |
|-----------------|-----------|---------|---------|
| MDA15 | 15 | 5 | 200 |



Yellow Brass: Type A Drain Off Cock - Capillary Extended

| MasterFlow Code | Size (mm) | Bag Qty | Box Qty |
|-----------------|-----------|---------|---------|
| MDA15E | 15 | 5 | 200 |



Yellow Brass: Bibcock with Hose Union

| MasterFlow Code | Size (mm) | Bag Qty | Box Qty |
|-----------------|-----------|---------|---------|
| MBHU04 | 1/2" | 1 | 40 |
| MBHU06 | 3/4" | 1 | 25 |
| MBHU04DCV | 1/2" | 1 | 40 |
| MBHU06DCV | 3/4" | 1 | 25 |



Yellow Brass: Hose Union Nut & Tail for Bibcock

| MasterFlow Code | Size (mm) | Bag Qty | Box Qty |
|-----------------|-----------|---------|---------|
| MHUNT04 | 1/2" | 1 | 200 |
| MHUNT06 | 3/4" | 1 | 100 |



Yellow Brass: HP Part 1 Float Valve



| MasterFlow Code | Size (mm) | Bag Qty | Box Qty |
|-----------------|---------------|---------|---------|
| MFVHP104 | 1/2" | 1 | 50 |
| MFVHP1046 | 1/2" - 6" Arm | 1 | 50 |
| MFVA6 | 6" Arm | 1 | 100 |
| MFVHP104BF | 1/2" | 1 | 50 |
| MFVHP106 | 3/4" | 1 | 25 |

Yellow Brass: HP Part 2 Float Valve



| MasterFlow Code | Size (mm) | Bag Qty | Box Qty |
|-----------------|-----------|---------|---------|
| MFVHP204 | 1/2" | 1 | 50 |

Yellow Brass: Valve Ball Float cw Brass Insert



| MasterFlow Code | Size (mm) | Bag Qty | Box Qty |
|-----------------|--------------|---------|---------|
| MFVBF4 | 4.1/2" Float | 1 | 50 |

Yellow Brass: LP Part 1 Float Valve



| MasterFlow Code | Size (mm) | Bag Qty | Box Qty |
|-----------------|-----------|---------|---------|
| MFVLP104 | 1/2" | 1 | 50 |

Yellow Brass: Lever Ball Valve F x F (Water only)

| MasterFlow Code | Size (mm) | Bag Qty | Box Qty |
|-----------------|-----------|---------|---------|
| M44020200 | 1/4" | 1 | 120 |
| M44030300 | 3/8" | 1 | 120 |
| M44040400 | 1/2" | 1 | 90 |
| M44060600 | 3/4" | 1 | 72 |
| M44080800 | 1" | 1 | 30 |
| M44101000 | 1.1/4" | 1 | 21 |
| M44121200 | 1.1/2" | 1 | 10 |
| M44161600 | 2" | 1 | 8 |



Yellow Brass: Lever Ball Valve C x C LP (Black Handle)

| MasterFlow Code | Size (mm) | Bag Qty | Box Qty |
|-----------------|-----------|---------|---------|
| M69150000LP | 15 | 1 | 70 |
| M69150000LPDZR | 15 | 5 | 100 |
| M69220000LP | 22 | 1 | 50 |
| M69220000FBDZR | 22 | 1 | 50 |
| M69280000LP | 28 | 1 | 30 |



Yellow Brass: Lever Ball Valve C x C LP (Red Handle)

| MasterFlow Code | Size (mm) | Bag Qty | Box Qty |
|-----------------|-----------|---------|---------|
| M69150000LPR | 15 | 1 | 70 |
| M69220000LPR | 22 | 1 | 50 |
| M69280000LPR | 28 | 1 | 30 |



Yellow Brass: Lever Ball Valve C x C LP (Blue Handle)



| MasterFlow Code | Size (mm) | Bag Qty | Box Qty |
|-----------------|-----------|---------|---------|
| M6915000LPB | 15 | 1 | 70 |
| M6922000LPB | 22 | 1 | 50 |
| M6928000LPB | 28 | 1 | 30 |

Yellow Brass: Full Bore Lever Ball Valve C x C



| MasterFlow Code | Size (mm) | Bag Qty | Box Qty |
|-----------------|-----------|---------|---------|
| M6915000FB | 15 | 1 | 70 |
| M6922000FB | 22 | 1 | 50 |
| M6928000FB | 28 | 1 | 30 |
| M6935000FB | 35 | 1 | 12 |
| M6942000FB | 42 | 1 | 8 |
| M6954000FB | 54 | 1 | 4 |

Yellow Brass: Butterfly Ball Valve



| MasterFlow Code | Size (mm) | Bag Qty | Box Qty |
|-----------------|-----------|---------|---------|
| M2815000BUT | 15 | 1 | 70 |
| M2822000BUT | 22 | 1 | 50 |
| M2828000BUT | 28 | 1 | 30 |

Yellow Brass CP: Straight Service Valve CP

| MasterFlow Code | Size (mm) | Bag Qty | Box Qty |
|-----------------|-----------|---------|---------|
| M40150400P | 15 x 1/2" | 1 | 150 |



Yellow Brass CP: Angle Service Valve CP

| MasterFlow Code | Size (mm) | Bag Qty | Box Qty |
|-----------------|-----------|---------|---------|
| M41150400P | 15 x 1/2" | 1 | 150 |



Yellow Brass: Isolating Valve Light Pattern

| MasterFlow Code | Size (mm) | Bag Qty | Box Qty |
|-----------------|-----------|---------|---------|
| M28150000 | 15 | 10 | 200 |
| M28220000 | 22 | 5 | 100 |



Yellow Brass CP: Isolating Valve Light Pattern CP



| MasterFlow Code | Size (mm) | Bag Qty | Box Qty |
|-----------------|-----------|---------|---------|
| M28150000P | 15 | 10 | 200 |
| M28150000DZRP | 15 | 5 | 100 |
| M28220000P | 22 | 10 | 200 |
| M28220000DZRP | 22 | 5 | 100 |

Yellow Brass: Lever Isolating Valve LP CHR



| MasterFlow Code | Size (mm) | Bag Qty | Box Qty |
|-----------------|-----------|---------|---------|
| M28150000LVP | 15 | 5 | 30 |

Yellow Brass: Lever Isolating Valve LP DZR CHR



| MasterFlow Code | Size (mm) | Bag Qty | Box Qty |
|-----------------|-----------|---------|---------|
| M28150000LVDZRP | 15 | 1 | 70 |

Yellow Brass: Isolating Valve Angled LP CHR



| MasterFlow Code | Size (mm) | Bag Qty | Box Qty |
|-----------------|-----------|---------|---------|
| M28150000AP | 15 | 5 | 100 |

Yellow Brass: Isolating Valve Heavy Pattern



| MasterFlow Code | Size (mm) | Bag Qty | Box Qty |
|-----------------|-----------|---------|---------|
| M32150000 | 15 | 5 | 160 |

Yellow Brass CP: Isolating Valve Heavy Pattern CP



| MasterFlow Code | Size (mm) | Bag Qty | Box Qty |
|-----------------|-----------|---------|---------|
| M32150000P | 15 | 5 | 160 |

Yellow Brass: Mi Isolating Valve CP



| MasterFlow Code | Size (mm) | Bag Qty | Box Qty |
|-----------------|-----------|---------|---------|
| M32150300P | 15 x 3/8" | 5 | 32 |
| M32150400P | 15 x 1/2" | 5 | 20 |

Yellow Brass: Angled Mi Isolating Valve CP



| MasterFlow Code | Size (mm) | Bag Qty | Box Qty |
|-----------------|-----------|---------|---------|
| M28150300AP | 15 x 3/8" | 5 | 32 |
| M28150400AP | 15 x 1.2" | 5 | 20 |

Yellow Brass CP: Full Bore Isolating Valve CP



| MasterFlow Code | Size (mm) | Bag Qty | Box Qty |
|-----------------|-----------|---------|---------|
| M30150000P* | 15 | 5 | 100 |
| M30150000DZRP | 15 | 5 | 100 |
| M30220000P* | 22 | 5 | 50 |
| M30220000DZRP | 22 | 5 | 50 |

Yellow Brass: Full Bore Isolating Valve



| MasterFlow Code | Size (mm) | Bag Qty | Box Qty |
|-----------------|-----------|---------|---------|
| M30150000 | 15 | 5 | 100 |
| M30220000 | 22 | 5 | 50 |

Yellow Brass: Single Check Valve

| MasterFlow Code | Size (mm) | Bag Qty | Box Qty |
|-----------------|-----------|---------|---------|
| MSCV1500 | 15 | 1 | 100 |
| MSCV2200 | 22 | 1 | 50 |
| MSCV2800 | 28 | 1 | 25 |



Yellow Brass: Double Check Valve

| MasterFlow Code | Size (mm) | Bag Qty | Box Qty |
|-----------------|-----------|---------|---------|
| M37150000 | 15 | 2 | 120 |
| M37220000 | 22 | 2 | 80 |
| M37220000DZR | 22 | 5 | 50 |
| M37280000 | 28 | 2 | 50 |



Yellow Brass: F x F Double Check Valve DZR

| MasterFlow Code | Size (mm) | Bag Qty | Box Qty |
|-----------------|-----------|---------|---------|
| M37040000DZR | 1/2" | 1 | 120 |
| M37060000DZR | 3/4" | 1 | 80 |
| M37080000DZR | 1" | 1 | 50 |
| M37100000DZR | 1.1/4" | 1 | 30 |
| M37120000DZR | 1.1/2" | 1 | 20 |
| M37160000DZR | 2" | 1 | 10 |



Yellow Brass CP: Straight Washing Machine Tap Light Pattern Single Check Valve

| MasterFlow Code | Size (mm) | Bag Qty | Box Qty |
|-----------------|-----------|---------|---------|
| MWM1506 | 15 x 3/4" | 1 | 150 |
| MWM1506DCV | 15 x 3/4" | 1 | 150 |



Yellow Brass CP: Angle Washing Machine Tap Light Pattern



| MasterFlow Code | Size (mm) | Bag Qty | Box Qty |
|-----------------|-----------|---------|---------|
| MWMA1506 | 15 x 3/4" | 1 | 150 |

Yellow Brass CP: Tee Washing Machine Tap Light Pattern



| MasterFlow Code | Size (mm) | Bag Qty | Box Qty |
|-----------------|-----------|---------|---------|
| MWMT1506 | 15 x 3/4" | 1 | 100 |

Yellow Brass: Washing Machine Brass 'Y' Connector



| MasterFlow Code | Size (mm) | Bag Qty | Box Qty |
|-----------------|-----------|---------|---------|
| MWMYCON | | 1 | |

Red: Washing Machine Hose



| MasterFlow Code | Size (mm) | Bag Qty | Box Qty |
|-----------------|-----------|---------|---------|
| MWMH15R | 1.5M | 1 | 25 |
| MWMH25R | 2.5M | 1 | 10 |

Blue: Washing Machine Hose

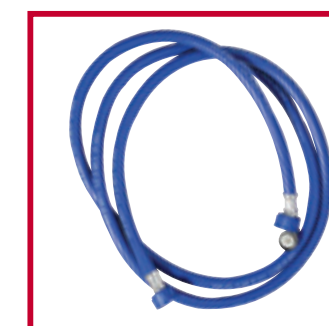

| MasterFlow Code | Size (mm) | Bag Qty | Box Qty |
|-----------------|-----------|---------|---------|
| MWMH15B | 1.5M | 1 | 25 |
| MWMH25B | 2.5M | 1 | 10 |

Grey: PVC Outlet Hose



| MasterFlow Code | Size (mm) | Bag Qty | Box Qty |
|-----------------|-----------|---------|---------|
| MWMHO15 | 1.5M | 1 | 5 |
| MWMHO25 | 2.5M | 1 | 5 |

Yellow Brass: Wall Plate And Copper Tail

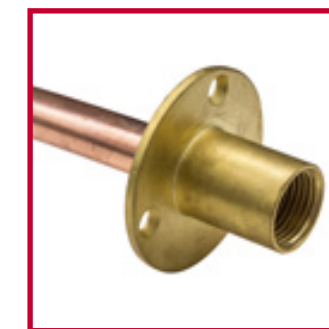

| MasterFlow Code | Size (mm) | Bag Qty | Box Qty |
|-----------------|-----------------|---------|---------|
| MWPCT1504350 | 15 x 1/2" x 350 | 1 | 20 |
| MWPCT1504600 | 15 x 1/2" x 600 | 1 | 20 |

Yellow Brass: 'Y' Strainer

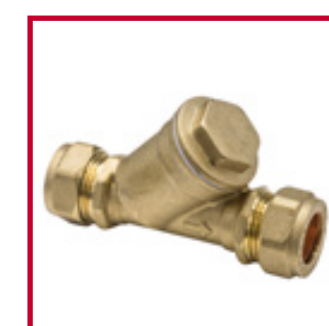

| MasterFlow Code | Size (mm) | Bag Qty | Box Qty |
|-----------------|-----------|---------|---------|
| MBYS15 | 15 | 1 | 100 |
| MBYS22 | 22 | 1 | 50 |

Flexi Hoses - WRAS Approved

- WRAS approved.
- Compliant with relevant British standards.
- Manufactured using high quality material.
- Supported by full manufacturer's warranty.



FH - WRAS Approved: F x F Flexible Tap Connector



| MasterFlow Code | Size (mm) | Bag Qty | Box Qty |
|-----------------|--------------------|---------|---------|
| MFLEXTC040430 | 1/2" x 1/2" x 30cm | 2 | 100 |
| MFLEXTC040450 | 1/2" x 1/2" x 50cm | 2 | 100 |

FH - WRAS Approved: C x F Flexible Tap Connector



| MasterFlow Code | Size (mm) | Bag Qty | Box Qty |
|-----------------|------------------|---------|---------|
| MFLEXTC150330 | 15 x 3/8 x 30cm | 2 | 160 |
| MFLEXTC150415 | 15 x 1/2" x 15cm | 2 | 100 |
| MFLEXTC150430 | 15 x 1/2 x 30cm | 2 | 160 |
| MFLEXTC150450 | 15 x 1/2 x 50cm | 2 | 120 |
| MFLEXTC150630 | 15 x 3/4 x 30cm | 2 | 150 |
| MFLEXTC150650 | 15 x 3/4 x 50cm | 2 | 120 |
| MFLEXTC220630 | 22 x 3/4 x 30cm | 2 | 100 |
| MFLEXTC220650 | 22 x 3/4 x 50cm | 2 | 80 |
| MFLEXTC220690 | 22 x 3/4 x 90cm | 2 | 80 |

FH - WRAS Approved: C x C Flexible Tap Connector

| MasterFlow Code | Size (mm) | Bag Qty | Box Qty |
|-----------------|----------------|---------|---------|
| MFLEXTC151530 | 15 x 15 x 30cm | 2 | 150 |
| MFLEXTC151550 | 15 x 15 x 50cm | 2 | 100 |
| MFLEXTC151590 | 15 x 15 x 90cm | 2 | 50 |
| MFLEXTC222230 | 22 x 22 x 30cm | 2 | 50 |
| MFLEXTC222250 | 22 x 22 x 50cm | 2 | 50 |



FH - WRAS Approved: C x F Flexible Tap Connector - Maximum Bore

| MasterFlow Code | Size (mm) | Bag Qty | Box Qty |
|-----------------|-----------------|---------|---------|
| MFLEXTC150430M | 15 x 1/2 x 30cm | 2 | 100 |



FH - WRAS Approved: C x C Flexible Tap Connector & ISO Valve

| MasterFlow Code | Size (mm) | Bag Qty | Box Qty |
|-----------------|----------------|---------|---------|
| MFLEXTC151530V | 15 x 15 x 30cm | 2 | 100 |



FH - WRAS Approved: C x F Flexible Tap Connector & ISO Valve



| MasterFlow Code | Size (mm) | Bag Qty | Box Qty |
|-----------------|------------------|---------|---------|
| MFLEXTC150415V | 15 x 1/2" x 15cm | 2 | 100 |
| MFLEXTC1504V | 15 x 1/2" x 30cm | 2 | 150 |
| MFLEXTC1510450V | 15 x 1/2" x 50cm | 2 | 100 |
| MFLEXTC1506V | 15 x 3/4" x 30cm | 2 | 150 |
| MFLEXTC1510650V | 15 x 3/4" x 50cm | 2 | 100 |
| MFLEXTC2206V | 22 x 3/4" x 30cm | 2 | 100 |

FH - WRAS Approved: C x C Flexible Tap Connector Pushfit



| MasterFlow Code | Size (mm) | Bag Qty | Box Qty |
|-----------------|----------------|---------|---------|
| MFLEXTC1515PF | 15 x 15 x 30cm | 2 | 100 |
| MFLEXTC151550PF | 15 x 15 x 50cm | 2 | 100 |

FH - WRAS Approved: Mono Basin Mixer Flexible Tap Connectors



| MasterFlow Code | Size (mm) | Bag Qty | Box Qty |
|-----------------|------------------|---------|---------|
| MFLEXMTC1004 | 10 x 1/2" x 30cm | 1 pair | 100 |
| MFLEXTC100450 | 10 x 1/2" x 50cm | 1 pair | 50 |
| MFLEXMTC1015 | 10 x 15 x 30cm | 1 pair | 50 |
| MFLEXTC120450 | 12 x 1/2" x 50cm | 1 pair | 50 |
| MFLEXMTC1204 | 12 x 1/2" x 30cm | 1 pair | 150 |
| MFLEXMTC1215 | 12 x 15 x 30cm | 1 pair | 75 |

FH - WRAS Approved: C x F Flexible Tap Connector Pushfit



| MasterFlow Code | Size (mm) | Bag Qty | Box Qty |
|-----------------|------------------|---------|---------|
| MFLEXTC1504PF | 15 x 1/2" x 30cm | 2 | 100 |
| MFLEXTC1506PF | 15 x 3/4" x 30cm | 2 | 100 |
| MFLEXTC150450PF | 15 x 1/2" x 50cm | 2 | 100 |
| MFLEXTC150490PF | 15 x 1/2" x 90cm | 2 | 26 |
| MFLEXTC150650PF | 15 x 3/4" x 50cm | 2 | 100 |
| MFLEXTC150690PF | 15 x 3/4" x 90cm | 2 | 26 |
| MFLEXTC2206PF | 22 x 3/4" x 30cm | 1 | 100 |

FH - WRAS Approved: C x F Flexible Tap Connector & ISO Valve Pushfit



| MasterFlow Code | Size (mm) | Bag Qty | Box Qty |
|-----------------|------------------|---------|---------|
| MFLEXTC1504VPF | 15 x 1/2" x 30cm | 1 | 100 |
| MFLEXTC2206VPF | 22 x 3/4" x 30cm | 1 | 100 |

Flexi Hoses - Non WRAS Approved

- Marked for full traceability.
- Compliant with relevant standards.
- Manufactured using high quality material.
- Supported by full manufacturer's warranty.



FH - Non WRAS Approved: Flexible Tap Connector Cu x Fi



| MasterFlow Code | Size (mm) | Bag Qty | Box Qty |
|-----------------|------------------|---------|---------|
| MFLEXTC150330E | 15 x 3/8" x 30cm | 2 | 160 |
| MFLEXTC150430E | 15 x 1/2" x 30cm | 2 | 160 |
| MFLEXTC150450E | 15 x 1/2" x 50cm | 2 | 120 |
| MFLEXTC150630E | 15 x 3/4" x 30cm | 2 | 150 |
| MFLEXTC150650E | 15 x 3/4" x 50cm | 2 | 120 |
| MFLEXTC220630E | 22 x 3/4" x 30cm | 2 | 100 |
| MFLEXTC220650E | 22 x 3/4" x 50cm | 2 | 80 |

FH - Non WRAS Approved: Flexible Tap Connector Cu x Cu



| MasterFlow Code | Size (mm) | Bag Qty | Box Qty |
|-----------------|----------------|---------|---------|
| MFLEXTC151530E | 15 x 15 x 30cm | 2 | 160 |

FH - Non WRAS Approved: Pushfit Flexible Tap Connector Cu x Fi

| MasterFlow Code | Size (mm) | Bag Qty | Box Qty |
|-----------------|-----------|---------|---------|
| MFLEXTC1504PE | 15 x 1/2" | 2 | 50 |
| MFLEXTC1506PE | 15 x 3/4" | 2 | 50 |
| MFLEXTC2206PE | 22 x 3/4" | 2 | 50 |



FH - Non WRAS Approved: Maximum Bore Flexible Tap Connector Cu x Fi

| MasterFlow Code | Size (mm) | Bag Qty | Box Qty |
|-----------------|------------------|---------|---------|
| MFLEXTC150430ME | 15 x 1/2" x 30cm | 2 | 100 |



FH - Non WRAS Approved: Pushfit Flexible Tap Connector Cu x Cu

| MasterFlow Code | Size (mm) | Bag Qty | Box Qty |
|-----------------|----------------|---------|---------|
| MFLEXTC1515PE | 15 x 15 x 30cm | 2 | 50 |



FH - Non WRAS Approved: Flexible Isovalve Tap Connector Cu x Fi

| MasterFlow Code | Size (mm) | Bag Qty | Box Qty |
|-----------------|-----------|---------|---------|
| MFLEXTC1504VE | 15 x 1/2" | 2 | 150 |
| MFLEXTC1506VE | 15 x 3/4" | 2 | 150 |
| MFLEXTC2206VE | 22 x 3/4" | 2 | 100 |



FH - Non WRAS Approved: Mono Flexi Tap Connector



| MasterFlow Code | Size (mm) | Bag Qty | Box Qty |
|-----------------|-----------|---------|---------|
| MFLEXMTC1004E | 10 x 1/2" | 1 pair | 100 |
| MFLEXMTC1204E | 12 x 1/2" | 1 pair | 100 |

FH - Non WRAS Approved: Pushfit Isovalve Tap Connector Cu x Fi



| MasterFlow Code | Size (mm) | Bag Qty | Box Qty |
|-----------------|----------------|---------|---------|
| MFLEXTC1504VPE | 15 x 1/2" x 30 | 2 | 50 |
| MFLEXTC2206VPE | 22 x 3/4" x 30 | 2 | 50 |

Heating Products

- WRAS Approved (where applicable)*
- Marked for full traceability.
- Compliant with relevant standards.
- Manufactured using high quality material.
- Supported by full manufacturer's warranty.

*See website for further details



Ground Face: Angled Wheelhead and Lockshield Valve (3/4" nut)

| MasterFlow Code | Size (mm) | Bag Qty | Box Qty |
|-----------------|-----------|---------|---------|
| MWLV10A | 10 | 1 | 50 |
| MWLV15A | 15 | 1 | 50 |



Ground Face: Straight Wheelhead and Lockshield Valve (3/4" nut)

| MasterFlow Code | Size (mm) | Bag Qty | Box Qty |
|-----------------|-----------|---------|---------|
| MWLV15S | 15 | 1 | 50 |



Ground Face: Angled Lockshield with Drain Off (3/4" nut)



| MasterFlow Code | Size (mm) | Bag Qty | Box Qty |
|-----------------|-----------|---------|---------|
| MWLV10AD | 10 | 1 | 50 |
| MWLV15AD | 15 | 1 | 50 |

Nut & Tail: BS2767 Angled Wheelhead and Lockshield Valve (1/2" nut)



| MasterFlow Code | Size (mm) | Bag Qty | Box Qty |
|-----------------|-----------|---------|---------|
| MWLNT0810 | 8 x 10 | 1 | 50 |
| MWLNT15 | 15 | 1 | 50 |

Nut & Tail: BS2767 Angled Lockshield with Drain Off (1/2" nut)



| MasterFlow Code | Size (mm) | Bag Qty | Box Qty |
|-----------------|-----------|---------|---------|
| MWLNT0810D | 8 x 10 | 1 | 50 |
| MWLNT15D | 15 | 1 | 50 |

Nut & Tail: Pushfit Elbow



| MasterFlow Code | Size (mm) | Bag Qty | Box Qty |
|-----------------|-----------|---------|---------|
| MRVPFE10 | 15 x 10 | 1 | 80 |
| MRVPFE15 | 15 x 15 | 1 | 80 |

Nut & Tail: Pushfit Straight



| MasterFlow Code | Size (mm) | Bag Qty | Box Qty |
|-----------------|-----------|---------|---------|
| MRVPFS10 | 10 | 1 | 80 |

Designer: Angled Radiator Valve (1/2" nut) (Pair)

| MasterFlow Code | Size (mm) | Bag Qty | Box Qty |
|-----------------|-----------|---------|---------|
| MRVAECO15P | 15 | 1 | 48 |



Designer: Straight Radiator Valve (1/2" nut) (Pair)

| MasterFlow Code | Size (mm) | Bag Qty | Box Qty |
|-----------------|-----------|---------|---------|
| MRVASECO15P | 15 | 1 | 48 |



Designer: All Chrome Luxury Angled Manual Radiator Valve (3/4" nut) (Pair)

| MasterFlow Code | Size (mm) | Bag Qty | Box Qty |
|-----------------|-----------|---------|---------|
| MAMRVA15LUXP | 15 | 1 | 30 |



Designer: All Chrome Luxury Straight Manual Radiator Valve (3/4" nut) (Pair)



| MasterFlow Code | Size (mm) | Bag Qty | Box Qty |
|-----------------|-----------|---------|---------|
| MAMRVS15LUXP | 15 | 1 | 30 |

Designer: All Chrome Luxury Corner Manual Radiator Valve (3/4" nut) (Pair)



| MasterFlow Code | Size (mm) | Bag Qty | Box Qty |
|-----------------|-----------|---------|---------|
| MAMRVC15LUXP | 15 | 1 | 30 |

Thermostatic Radiator Valve - TRV1 Angle (1/2 nut")



| MasterFlow Code | Size (mm) | Bag Qty | Box Qty |
|-----------------|-----------|---------|---------|
| MTRV1A | 15 | 1 | 50 |

Thermostatic Radiator Valve - TRV1 Straight (1/2 nut")



| MasterFlow Code | Size (mm) | Bag Qty | Box Qty |
|-----------------|-----------|---------|---------|
| MTRV1S | 15 | 1 | 24 |

Thermostatic Radiator Valve & Lockshield Pack (1/2" nut)

| MasterFlow Code | Size (mm) | Bag Qty | Box Qty |
|-----------------|-----------|---------|---------|
| MTRVPK1 | 15 | 1 | 45 |



Luxury all Chrome Thermo Angled Rad Valve (1/2 nut")

| MasterFlow Code | Size (mm) | Bag Qty | Box Qty |
|-----------------|-----------|---------|---------|
| MTRV2ALP | 15 | 1 | 50 |



Luxury Chrome Thermo Straight Rad Valve (1/2 nut")

| MasterFlow Code | Size (mm) | Bag Qty | Box Qty |
|-----------------|-----------|---------|---------|
| MTRV2SLP | 15 | 1 | 50 |



Luxury all Chrome Angled TRV Valve and Lockshield (1/2 nut")

| MasterFlow Code | Size (mm) | Bag Qty | Box Qty |
|-----------------|-----------|---------|---------|
| MTRVPK2LP | 15 | 1 | 20 |



Radiator Extension Chrome



| MasterFlow Code | Size (mm) | Bag Qty | Box Qty |
|-----------------|-----------|---------|---------|
| MRADEX10P | 10 | 5 | 400 |
| MRADEX20P | 20 | 5 | 300 |
| MRADEX40P | 40 | 5 | 200 |
| MRADEX60P | 60 | 5 | 160 |

Radiator Tail Extension Chrome



| MasterFlow Code | Size (mm) | Bag Qty | Box Qty |
|-----------------|-----------|---------|---------|
| MRADTAIL75P | 75 | 1 | 200 |

Gate Type Pump Valve (WRAS Approved)



| MasterFlow Code | Size (mm) | Bag Qty | Box Qty |
|-----------------|-----------|---------|---------|
| MPVG22 | 22 | 1 | 50 |
| MPVG28 | 28 | 1 | 50 |

Ball Type Pump Valve (WRAS Approved)



| MasterFlow Code | Size (mm) | Bag Qty | Box Qty |
|-----------------|-----------|---------|---------|
| MPVB22 | 22 | 1 | 60 |
| MPVB28 | 28 | 1 | 60 |

Pump Valve Gasket

| MasterFlow Code | Size (mm) | Bag Qty | Box Qty |
|-----------------|-----------|---------|---------|
| MPVG12 | 1.1/2" | 1 | 300 |

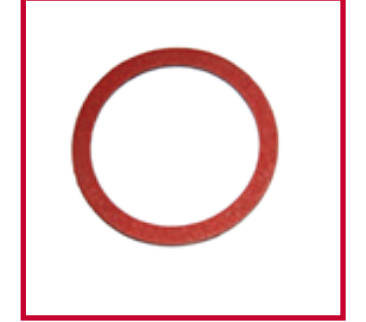

Straight Filling Loop (WRAS Approved)

| MasterFlow Code | Size (mm) | Bag Qty | Box Qty |
|-----------------|-----------|---------|---------|
| MFILLOOP | 15 | 1 | 40 |



Tee Filling Loop (WRAS Approved)

| MasterFlow Code | Size (mm) | Bag Qty | Box Qty |
|-----------------|-----------|---------|---------|
| MFILLOPT | 15 | 1 | 50 |



R24 Filling Loop (WRAS Approved)

| MasterFlow Code | Size (mm) | Bag Qty | Box Qty |
|-----------------|-----------|---------|---------|
| MFILLOOP24 | 15 | 1 | 60 |



Thermostatic Blending Valve TMV2/3



| MasterFlow Code | Size (mm) | Bag Qty | Box Qty |
|------------------|-----------|---------|---------|
| MTBVU23 (TMV2/3) | 15 | 1 | 24 |

Thermostatic Blending Valve TMV2 / TMV3 Eco



| MasterFlow Code | Size (mm) | Bag Qty | Box Qty |
|-----------------|-----------|---------|---------|
| MTBVU23E | 15 | 1 | 24 |

Pressure Relief Valve Gauge



| MasterFlow Code | Size (mm) | Bag Qty | Box Qty |
|-----------------|-----------|---------|---------|
| MPRVPG026 | 1/4" | 1 | 100 |

Pressure Reducing Valves c/w Gauge (WRAS Approved)



| MasterFlow Code | Size (mm) | Bag Qty | Box Qty |
|-----------------|-----------|---------|---------|
| MPRV15G | 15 | 1 | 20 |
| MPRV22G | 22 | 1 | 20 |

Bottle Auto Air Vent

| MasterFlow Code | Size (mm) | Bag Qty | Box Qty |
|-----------------|-----------|---------|---------|
| MBAV03 | 3/8" | 1 | 50 |
| MBAV04 | 1/2" | 1 | 50 |
| MBAV15 | 15 | 1 | 50 |



Directional Radiator Vent Chrome

| MasterFlow Code | Size (mm) | Bag Qty | Box Qty |
|-----------------|-----------|---------|---------|
| MDRV04P | 1/2" | 10 | 1000 |



Radiator Plug Chrome

| MasterFlow Code | Size (mm) | Bag Qty | Box Qty |
|-----------------|-----------|---------|---------|
| MRP04P | 1/2" | 10 | 1000 |



Brass Rad Vent Key

| MasterFlow Code | Size (mm) | Bag Qty | Box Qty |
|-----------------|-----------|---------|---------|
| MRKTB | | 5 | 1000 |



Clock Type Rad Key



| MasterFlow Code | Size (mm) | Bag Qty | Box Qty |
|-----------------|-----------|---------|---------|
| MRKCT | | 5 | 1000 |

Nail On Clip



| MasterFlow Code | Size (mm) | Bag Qty | Box Qty |
|-----------------|-----------|---------|---------|
| MNC08 | 8 | 100 | 120 |
| MNC10 | 10 | 100 | 80 |
| MNC15 | 15 | 100 | 40 |
| MNC22 | 22 | 50 | 60 |
| MNC28 | 28 | 50 | 40 |

Single Hinged Clip



| MasterFlow Code | Size (mm) | Bag Qty | Box Qty |
|-----------------|-----------|---------|---------|
| MHCS15 | 15 | 100 | 40 |
| MHCS22 | 22 | 100 | 20 |
| MHCS28 | 28 | 50 | 40 |

Double Hinged Clip

| MasterFlow Code | Size (mm) | Bag Qty | Box Qty |
|-----------------|-----------|---------|---------|
| MHCD15 | 15 | 50 | 20 |
| MHCD22 | 22 | 50 | 30 |



Hinged Clip Spacer

| MasterFlow Code | Size (mm) | Bag Qty | Box Qty |
|-----------------|-----------|---------|---------|
| MHCSPACER | N/A | 100 | 6000 |



P.T.F.E Tape

| MasterFlow Code | Size (mm) | Bag Qty | Box Qty |
|-----------------|-----------|---------|---------|
| MPTFE | N/A | 10 | 500 |



Gas Fittings

- Marked for full traceability.
- Supported by full manufacturer's warranty.
- Compliant with relevant standards.
- Manufactured using high quality material.



Gas Fittings: Straight C + C Mini Ball Valve Chrome



| MasterFlow Code | Size (mm) | Bag Qty | Box Qty |
|-----------------|-----------|---------|---------|
| M61080000G | 8 | 10 | 300 |
| M61100000G | 10 | 10 | 250 |
| M61150000G | 15 | 10 | 140 |

Gas Fittings: Straight Reducing C + C Mini Ball Valve Chrome



| MasterFlow Code | Size (mm) | Bag Qty | Box Qty |
|-----------------|-----------|---------|---------|
| M61100800G | 10 to 8 | 1 | 250 |
| M61150800G | 15 to 8 | 1 | 200 |
| M61151000G | 15 to 10 | 10 | 200 |

Gas Fittings: Bent C + C Mini Ball Valve Chrome



| MasterFlow Code | Size (mm) | Bag Qty | Box Qty |
|-----------------|-----------|---------|---------|
| M62080000G | 8 | 1 | 200 |
| M62100000G | 10 | 1 | 150 |

Gas Fittings: Straight C + C Mini Ball Valves c/w Fi x Brkt Chrome

| MasterFlow Code | Size (mm) | Bag Qty | Box Qty |
|-----------------|-----------|---------|---------|
| M64080000G | 8 | 1 | 200 |
| M64100000G | 10 | 1 | 180 |



Gas Fittings: Straight C + MI Taper Mini Ball Valve Chrome

| MasterFlow Code | Size (mm) | Bag Qty | Box Qty |
|-----------------|-----------|---------|---------|
| M65100200G | 10 x 1/4" | 1 | 40 |
| M65100300G | 10 x 3/8" | 1 | 40 |



Gas Fittings: Lever Ball Valves (Yellow Handle)

| MasterFlow Code | Size (mm) | Bag Qty | Box Qty |
|-----------------|-----------|---------|---------|
| M69150000G | 15 | 1 | 50 |
| M69220000G | 22 | 1 | 40 |
| M69280000G | 28 | 1 | 25 |
| M69030000G | 3/8" | 1 | 140 |
| M69040000G | 1/2" | 1 | 80 |
| M69060000G | 3/4" | 1 | 40 |
| M69080000G | 1" | 1 | 36 |
| M69100000G | 1.1/4" | 1 | 17 |
| M69120000G | 1.1/2" | 1 | 12 |
| M69160000G | 2" | 1 | 8 |



Gas Fittings: Brass C + C ISO Gas Valves

| MasterFlow Code | Size (mm) | Bag Qty | Box Qty |
|-----------------|-----------|---------|---------|
| MISOGAS08 | 8 | 1 | 250 |
| MISOGAS10 | 10 | 1 | 200 |
| MISOGAS15 | 15 | 1 | 180 |
| MISOGAS22 | 22 | 1 | 100 |



Gas Fittings: Micro Straight Cooker Socket



| MasterFlow Code | Size (mm) | Bag Qty | Box Qty |
|-----------------|-----------|---------|---------|
| MCMSS | 1/2" | 1 | 150 |

Gas Fittings: Bent Bayonet Connector



| MasterFlow Code | Size (mm) | Bag Qty | Box Qty |
|-----------------|-----------|---------|---------|
| MCBB | 1/2" | 1 | 100 |

Gas Fittings: Straight Bayonet Connector



| MasterFlow Code | Size (mm) | Bag Qty | Box Qty |
|-----------------|-----------|---------|---------|
| MCBS | 1/2" | 1 | 100 |

Gas Fittings: Stainless Steel Cooker Hob Connector



| MasterFlow Code | Size (mm) | Bag Qty | Box Qty |
|-----------------|---------------------|---------|---------|
| MHOBCON | 15mm x 1/2" x 600mm | 1 | 10 |

Gas Fittings: Catering Hose Quick Release

| MasterFlow Code | Size (mm) | Bag Qty | Box Qty |
|-----------------|---------------|---------|---------|
| MCH041000 | 1000mm x 1/2" | 1 | 10 |
| MCH041500 | 1500mm x 1/2" | 1 | 8 |
| MCH061000 | 1000mm x 3/4" | 1 | 8 |
| MCH061500 | 1500mm x 3/4" | 1 | 8 |

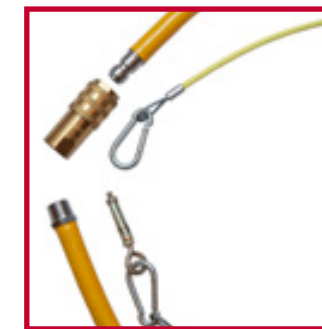

Gas Fittings: Micro Angled Cooker Hose 3ft

| MasterFlow Code | Size (mm) | Bag Qty | Box Qty |
|-----------------|-----------|---------|---------|
| MCHM3 | 3/8" | 1 | 1 |



Gas Fittings: Bayonet Cooker Hose

| MasterFlow Code | Size (mm) | Bag Qty | Box Qty |
|-----------------|-----------|---------|---------|
| MCHB3 | 3ft | 1 | 1 |
| MCHB4 | 4ft | 1 | 1 |



Gas Fittings: Bayonet LPG Cooker Hose 3ft

| MasterFlow Code | Size (mm) | Bag Qty | Box Qty |
|-----------------|-----------|---------|---------|
| MCHB3L | 3ft | 1 | 1 |



Gas Fittings: Meter Union BS746

| MasterFlow Code | Size (mm) | Bag Qty | Box Qty |
|-----------------|-----------|---------|---------|
| MCMUBS746 | 28 x 1" | 10 | 120 |

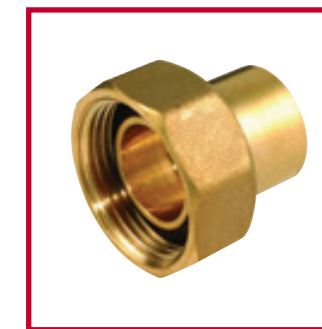

Gas Fittings: Meter Union Grooved



| MasterFlow Code | Size (mm) | Bag Qty | Box Qty |
|-----------------|-----------|---------|---------|
| MCMUG | 22 x 1" | 10 | 140 |

Gas Fittings: Meter Union Washer



| MasterFlow Code | Size (mm) | Bag Qty | Box Qty |
|-----------------|-----------|---------|---------|
| MCMUW | N/A | 1 | 200 |

Gas Fittings: Cooker Stability Chain & Hook



| MasterFlow Code | Size (mm) | Bag Qty | Box Qty |
|-----------------|-----------|---------|---------|
| MCSCH | | 1 | 200 |

Gas Fittings: Pressure Test Nipple



| MasterFlow Code | Size (mm) | Bag Qty | Box Qty |
|-----------------|-----------|---------|---------|
| MCPTN | 1/8" | 10 | 150 |

Gas Fittings: Backplate Adaptor Angled



| MasterFlow Code | Size (mm) | Bag Qty | Box Qty |
|-----------------|-----------|---------|---------|
| MBA1504A | 15 x 1/2" | 1 | 120 |

Gas Fittings: Backplate Adaptor Capillary



| MasterFlow Code | Size (mm) | Bag Qty | Box Qty |
|-----------------|-----------|---------|---------|
| MBA1504C | 15 x 1/2" | 1 | 140 |

Gas Fittings: Backplate Adaptor Straight



| MasterFlow Code | Size (mm) | Bag Qty | Box Qty |
|-----------------|-----------|---------|---------|
| MBA1504S | 15 x 1/2" | 1 | 150 |

Gas Fittings: Gas PTFE Tape



| MasterFlow Code | Size (mm) | Bag Qty | Box Qty |
|-----------------|-----------|---------|---------|
| MPTFEG | N/A | 10 | 250 |

Taps

- Marked for full traceability.
- Supported by full manufacturer's warranty.
- Compliant with relevant standards.
- Manufactured using high quality material.



Taps Base: Mono Basin Mixer c/w PU Waste Chrome

| MasterFlow Code | Size (mm) | Bag Qty | Box Qty |
|-----------------|-----------|---------|---------|
| BA100C | 1/2" | 1 | N/A |



Taps Base: BSM Chrome

| MasterFlow Code | Size (mm) | Bag Qty | Box Qty |
|-----------------|-----------|---------|---------|
| BA400C | 3/4" | 1 | N/A |



Taps Base: Basin Taps Chrome



| MasterFlow Code | Size (mm) | Bag Qty | Box Qty |
|-----------------|-----------|---------|---------|
| BA200C | 1/2" | 1 | N/A |

Taps Base: Bath Filler Chrome

| MasterFlow Code | Size (mm) | Bag Qty | Box Qty |
|-----------------|-----------|---------|---------|
| BA500C | 3/4" | 1 | N/A |



Taps Base: Bath Taps Chrome



| MasterFlow Code | Size (mm) | Bag Qty | Box Qty |
|-----------------|-----------|---------|---------|
| BA300C | 3/4" | 1 | N/A |

Taps Base: Highneck Pillar Taps Chrome

| MasterFlow Code | Size (mm) | Bag Qty | Box Qty |
|-----------------|-----------|---------|---------|
| BA700C | 1/2" | 1 | N/A |



Taps Base: Monosink Mixer Chrome



| MasterFlow Code | Size (mm) | Bag Qty | Box Qty |
|-----------------|-----------|---------|---------|
| BA702C | 1/2" | 1 | N/A |

Taps Base: Decksink Mixer Chrome



| MasterFlow Code | Size (mm) | Bag Qty | Box Qty |
|-----------------|-----------|---------|---------|
| BA701C | 1/2" | 1 | N/A |

Taps Base Level: Basin Taps Chrome



| MasterFlow Code | Size (mm) | Bag Qty | Box Qty |
|-----------------|-----------|---------|---------|
| BAL200C | 1/2" | 1 | N/A |

Taps Base Level: Bath Taps Chrome



| MasterFlow Code | Size (mm) | Bag Qty | Box Qty |
|-----------------|-----------|---------|---------|
| BAL300C | 3/4" | 1 | N/A |

Taps Base Level: Mono Basin Mixer c/w PU Waste Chrome



| MasterFlow Code | Size (mm) | Bag Qty | Box Qty |
|-----------------|-----------|---------|---------|
| BAL100C | 1/2" | 1 | N/A |

Taps Base Level: BSM Chrome



| MasterFlow Code | Size (mm) | Bag Qty | Box Qty |
|-----------------|-----------|---------|---------|
| BAL400C | 3/4" | 1 | N/A |

Taps Base Level: Bath Filler Chrome



| MasterFlow Code | Size (mm) | Bag Qty | Box Qty |
|-----------------|-----------|---------|---------|
| BAL500C | 3/4" | 1 | N/A |

Taps Base Level: Highneck Pillar Taps Chrome



| MasterFlow Code | Size (mm) | Bag Qty | Box Qty |
|-----------------|-----------|---------|---------|
| BAL700C | 1/2" | 1 | N/A |

Taps Base Level: Monosink Mixer Chrome



| MasterFlow Code | Size (mm) | Bag Qty | Box Qty |
|-----------------|-----------|---------|---------|
| BAL702C | 1/2" | 1 | N/A |

Taps Base Level: Decksink Mixer Chrome



| MasterFlow Code | Size (mm) | Bag Qty | Box Qty |
|-----------------|-----------|---------|---------|
| BAL701C | 1/2" | 1 | N/A |

Taps Base Crosshead: Basin Taps Chrome



| MasterFlow Code | Size (mm) | Bag Qty | Box Qty |
|-----------------|-----------|---------|---------|
| BAX200C | 1/2" | 1 | N/A |

Taps Base Crosshead: Bath Taps Chrome



| MasterFlow Code | Size (mm) | Bag Qty | Box Qty |
|-----------------|-----------|---------|---------|
| BAX300C | 3/4" | 1 | N/A |

Taps Base Crosshead: Highneck Pillar Taps Chrome



| MasterFlow Code | Size (mm) | Bag Qty | Box Qty |
|-----------------|-----------|---------|---------|
| BAX700C | 1/2" | 1 | N/A |

Taps Base Contemporary: Basin Taps Chrome



| MasterFlow Code | Size (mm) | Bag Qty | Box Qty |
|-----------------|-----------|---------|---------|
| BAC200C | 1/2" | 1 | N/A |

Taps Base Contemporary: Bath Taps Chrome



| MasterFlow Code | Size (mm) | Bag Qty | Box Qty |
|-----------------|-----------|---------|---------|
| BAC300C | 3/4" | 1 | N/A |

Taps Base Contemporary: Mono Basin Mixer c/w Clicker Waste Chrome



| MasterFlow Code | Size (mm) | Bag Qty | Box Qty |
|-----------------|-----------|---------|---------|
| BAC100KC | 1/2" | 1 | N/A |

Taps Base Contemporary: Mini Mono Basin Mixer c/w Clicker Waste Chrome



| MasterFlow Code | Size (mm) | Bag Qty | Box Qty |
|-----------------|-----------|---------|---------|
| BAC104KC | 1/2" | 1 | N/A |

Taps Base Contemporary: Bath Shower Mixer Chrome



| MasterFlow Code | Size (mm) | Bag Qty | Box Qty |
|-----------------|-----------|---------|---------|
| BAC400C | 3/4" | 1 | N/A |

Taps Base Contemporary: Base Contemporary Bath Filler Chrome



| MasterFlow Code | Size (mm) | Bag Qty | Box Qty |
|-----------------|-----------|---------|---------|
| BAC500C | 3/4" | 1 | N/A |

Taps Asti Lever: Basin Taps Chrome (Pair)



| MasterFlow Code | Size (mm) | Bag Qty | Box Qty |
|-----------------|-----------|---------|---------|
| ASL200C | 1/2" | 1 | 0 |

Taps Asti Lever: Bath Taps Chrome (3/4" nut)

| MasterFlow Code | Size (mm) | Bag Qty | Box Qty |
|-----------------|-----------|---------|---------|
| ASL300C | 1/2" | 1 | 0 |



Taps Asti Lever: Mono Basin Mixer c/w Clicker Waste Chrome

| MasterFlow Code | Size (mm) | Bag Qty | Box Qty |
|-----------------|-----------|---------|---------|
| ASL100KC | 1/2" | 1 | N/A |



Taps Asti Lever: Mini Mono Basin Mixer c/w Clicker Waste Chrome

| MasterFlow Code | Size (mm) | Bag Qty | Box Qty |
|-----------------|-----------|---------|---------|
| ASL104KC | 1/2" | 1 | N/A |



Taps Asti Lever: Bath Shower Mixer Chrome

| MasterFlow Code | Size (mm) | Bag Qty | Box Qty |
|-----------------|-----------|---------|---------|
| ASL400C | 3/4" | 1 | N/A |



Taps Asti Lever: Bath Filler Chrome



| MasterFlow Code | Size (mm) | Bag Qty | Box Qty |
|-----------------|-----------|---------|---------|
| ASL500C | 3/4" | 1 | N/A |

Taps Cubica: Mono Basin Mixer c/w Clicker Waste Chrome



| MasterFlow Code | Size (mm) | Bag Qty | Box Qty |
|-----------------|-----------|---------|---------|
| CU100KC | 1/2" | 1 | N/A |

Taps Cubica: Mini Mono Basin Mixer c/w Clicker Waste Chrome



| MasterFlow Code | Size (mm) | Bag Qty | Box Qty |
|-----------------|-----------|---------|---------|
| CU104KC | 1/2" | 1 | N/A |

Taps Cubica: Bath Shower Mixer Chrome



| MasterFlow Code | Size (mm) | Bag Qty | Box Qty |
|-----------------|-----------|---------|---------|
| CU400C | 3/4" | 1 | N/A |

Taps Cubica: Bath Filler Chrome



| MasterFlow Code | Size (mm) | Bag Qty | Box Qty |
|-----------------|-----------|---------|---------|
| CU500C | 3/4" | 1 | N/A |

Taps Cascata Waterfall: Mono Basin Mixer c/w Clicker Waste Chrome (1/2" nut)



| MasterFlow Code | Size (mm) | Bag Qty | Box Qty |
|-----------------|-----------|---------|---------|
| CW100KC | 3/4" | 1 | N/A |

Taps Cascata Waterfall: Mini Mono Basin Mixer c/w Clicker Waste Chrome



| MasterFlow Code | Size (mm) | Bag Qty | Box Qty |
|-----------------|-----------|---------|---------|
| CW104KC | 1/2" | 1 | N/A |

Taps Cascata Waterfall: Tall Mono Basin Mixer no Waste Chrome



| MasterFlow Code | Size (mm) | Bag Qty | Box Qty |
|-----------------|-----------|---------|---------|
| CW105NC | 1/2" | 1 | N/A |

Taps Cascata Waterfall: Bath Shower Mixer Chrome



| MasterFlow Code | Size (mm) | Bag Qty | Box Qty |
|-----------------|-----------|---------|---------|
| CW400C | 3/4" | 1 | N/A |

Taps Cascata Waterfall: Bath Filler Chrome



| MasterFlow Code | Size (mm) | Bag Qty | Box Qty |
|-----------------|-----------|---------|---------|
| CW500C | 3/4" | 1 | N/A |

Taps Base Non Concussive: 01 Basin Taps (WRAS Approved) (Pair)



| MasterFlow Code | Size (mm) | Bag Qty | Box Qty |
|-----------------|-----------|---------|---------|
| BNC01CP | 1/2" | 1 | N/A |

Taps Base Non Concussive: 02 Basin Taps (Pair)



| MasterFlow Code | Size (mm) | Bag Qty | Box Qty |
|-----------------|-----------|---------|---------|
| BNC02CP | 1/2" | 1 | N/A |

Showers

- Marked for full traceability.
- Supported by full manufacturer's warranty.
- Compliant with relevant standards.
- Manufactured using high quality chrome material.



Showers: Base Bar Shower Valve Chrome

| MasterFlow Code | Size (mm) | Bag Qty | Box Qty |
|-----------------|-----------|---------|---------|
| BABSVK | 1/2" | 1 | N/A |



Showers: Asti Lever Bar Shower Valve Chrome

| MasterFlow Code | Size (mm) | Bag Qty | Box Qty |
|-----------------|-----------|---------|---------|
| ASLBSVK | 1/2" | 1 | N/A |



Showers: Asti Cross Bar Shower Valve Chrome

| MasterFlow Code | Size (mm) | Bag Qty | Box Qty |
|-----------------|-----------|---------|---------|
| ASX BSVK | 1/2" | 1 | N/A |



Showers: Rieta Square Bar Shower Valve Chrome



| MasterFlow Code | Size (mm) | Bag Qty | Box Qty |
|-----------------|-----------|---------|---------|
| RSQBSVC | 1/2" | 1 | N/A |

Showers: Rieta Square Bar Shower c/w Diverter, Rigid Riser, Fixed Head and Handset



| MasterFlow Code | Size (mm) | Bag Qty | Box Qty |
|-----------------|-----------|---------|---------|
| RSQBSDRRHC | 1/2" | 1 | N/A |

Showers: Base Deluxe Bar Shower Valve Chrome (TMV2)



| MasterFlow Code | Size (mm) | Bag Qty | Box Qty |
|-----------------|-----------|---------|---------|
| BADBSVC | 1/2" | 1 | N/A |

Showers: Base Single Function Shower Kit Chrome



| MasterFlow Code | Size (mm) | Bag Qty | Box Qty |
|-----------------|-----------|---------|---------|
| BASKSC | 1/2" | 1 | N/A |

Showers: Lucca Bar Shower Valve Chrome



| MasterFlow Code | Size (mm) | Bag Qty | Box Qty |
|-----------------|-----------|---------|---------|
| LUBSVC | 1/2" | 1 | N/A |

Showers: Base Multi Function Shower Kit Chrome



| MasterFlow Code | Size (mm) | Bag Qty | Box Qty |
|-----------------|-----------|---------|---------|
| BASKMC | 1/2" | 1 | N/A |

Showers: Asti Bar Shower c/w Diverter, Rigid Riser, Fixed Head and Handset



| MasterFlow Code | Size (mm) | Bag Qty | Box Qty |
|-----------------|-----------|---------|---------|
| ASBSDRRHC | 1/2" | 1 | N/A |

Showers: Base Single Function Handset Chrome



| MasterFlow Code | Size (mm) | Bag Qty | Box Qty |
|-----------------|-----------|---------|---------|
| BAHSC | 1/2" | 1 | N/A |

Showers: Base Multi Function Handset Chrome



| MasterFlow Code | Size (mm) | Bag Qty | Box Qty |
|-----------------|-----------|---------|---------|
| BAHMC | 1/2" | 1 | N/A |

Showers: Base Single Function Fixed Shower Head Chrome



| MasterFlow Code | Size (mm) | Bag Qty | Box Qty |
|-----------------|-----------|---------|---------|
| BAHFSC | 1/2" | 1 | N/A |

Showers: Base Multi Function Fixed Shower Head Chrome



| MasterFlow Code | Size (mm) | Bag Qty | Box Qty |
|-----------------|-----------|---------|---------|
| BAHFMC | 1/2" | 1 | N/A |

Showers: Base Shower Arm & Single Function Shower Head



| MasterFlow Code | Size (mm) | Bag Qty | Box Qty |
|-----------------|-----------|---------|---------|
| BASAFHC | 1/2" | 1 | N/A |

Showers: Base Vertical Shower Arm Chrome



| MasterFlow Code | Size (mm) | Bag Qty | Box Qty |
|-----------------|-----------|---------|---------|
| BASAVC | 1/2" | 1 | N/A |

Showers: Base 300mm Shower Arm Chrome

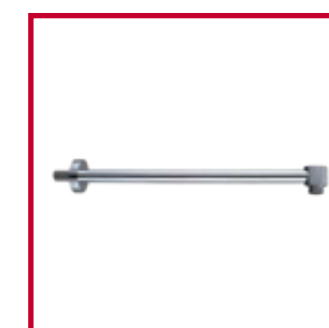

| MasterFlow Code | Size (mm) | Bag Qty | Box Qty |
|-----------------|-----------|---------|---------|
| BASA300C | 1/2" | 1 | N/A |

Showers: Base Wall Mount Shower Bracket Chrome



| MasterFlow Code | Size (mm) | Bag Qty | Box Qty |
|-----------------|-----------|---------|---------|
| BAWMSBC | 15 | 1 | N/A |

Showers: Base Wall Mount Brackets Chrome (Pair)



| MasterFlow Code | Size (mm) | Bag Qty | Box Qty |
|-----------------|-----------|---------|---------|
| BAWMBC | 1/2" | 1 | N/A |

Showers: Rieta Square Wall Mount Brackets Chrome (Pair)

| MasterFlow Code | Size (mm) | Bag Qty | Box Qty |
|-----------------|-----------|---------|---------|
| RSQWMBC | 1/2" | 1 pair | 0 |



Showers: Asti Shower Wall Outlet Chrome

| MasterFlow Code | Size (mm) | Bag Qty | Box Qty |
|-----------------|-----------|---------|---------|
| ASSWOC | 1/2" | 1 | N/A |



Showers: Rieta Square Shower Wall Outlet Chrome

| MasterFlow Code | Size (mm) | Bag Qty | Box Qty |
|-----------------|-----------|---------|---------|
| RSQSWOC | 1/2" | 1 | N/A |



Showers: Shower Hose Cone to Hex. 11mm Bore

| MasterFlow Code | Size (mm) | Bag Qty | Box Qty |
|-----------------|-----------|---------|---------|
| BASHCH15C | 1.5m | 1 | 0 |
| BASHCH175C | 1.75m | 1 | 0 |



Showers: Base Non Concussive Shower Valve Chrome

| MasterFlow Code | Size (mm) | Bag Qty | Box Qty |
|-----------------|-----------|---------|---------|
| BNC SVC | N/A | 1 | 0 |



Traps & Wastes

- Marked for full traceability.
- Supported by full manufacturer's warranty.
- Compliant with relevant standards.
- Manufactured using high quality chrome material.



Wastes: Pop-Up Bath Waste Chrome

| MasterFlow Code | Size (mm) | Bag Qty | Box Qty |
|-----------------|-----------|---------|---------|
| WBTPUC | 1.1/2" | 1 | N/A |



Wastes: Bath Waste C/W Metal Plug

| MasterFlow Code | Size (mm) | Bag Qty | Box Qty |
|-----------------|-----------|---------|---------|
| WBTMPCC | 1.1/2" | 1 | 50 |



Traps: Round Bottle Trap Chrome



| MasterFlow Code | Size (mm) | Bag Qty | Box Qty |
|-----------------|-----------|---------|---------|
| BTRC | 1.1/4" | 1 | N/A |

Wastes: Bath Waste C/W Poly Plug & SS Flange

| MasterFlow Code | Size (mm) | Bag Qty | Box Qty |
|-----------------|-----------|---------|---------|
| WBTPPCSS | 1.1/2" | 1 | 50 |



Traps: Square Bottle Trap Chrome



| MasterFlow Code | Size (mm) | Bag Qty | Box Qty |
|-----------------|-----------|---------|---------|
| BTSC | 1.1/4" | 1 | N/A |

Wastes: Stubby Bath Waste Chrome

| MasterFlow Code | Size (mm) | Bag Qty | Box Qty |
|-----------------|-----------|---------|---------|
| WBTSTUBC | 1.1/2" | 1 | 50 |



Wastes: Eco Combination Sink Waste



| MasterFlow Code | Size (mm) | Bag Qty | Box Qty |
|-----------------|-----------|---------|---------|
| WSNKCPSS | 1.1/2" | 1 | 60 |

Wastes: Slotted Brass Basin Waste, Plug, Chain & Stay - Chrome



| MasterFlow Code | Size (mm) | Bag Qty | Box Qty |
|-----------------|-----------|---------|---------|
| WBSPCC | 1.1/4" | 1 | N/A |

Wastes: Slotted Brass Basin Waste C/W Poly Plug, Chain & Stay Chrome



| MasterFlow Code | Size (mm) | Bag Qty | Box Qty |
|-----------------|-----------|---------|---------|
| WBSPPCC | 1.1/4" | 1 | 50 |

Wastes: Slotted Eco Basin Waste C/W Poly Plug, Chain & Stay Chrome



| MasterFlow Code | Size (mm) | Bag Qty | Box Qty |
|-----------------|-----------|---------|---------|
| WBSPPP | 1.1/4" | 1 | 50 |

Wastes: Slotted Brass Basin Clicker Waste - Chrome



| MasterFlow Code | Size (mm) | Bag Qty | Box Qty |
|-----------------|-----------|---------|---------|
| WBSCSC | 1.1/4" | 1 | N/A |

Wastes: Unslotted Brass Basin Clicker Waste - Chrome



| MasterFlow Code | Size (mm) | Bag Qty | Box Qty |
|-----------------|-----------|---------|---------|
| WBSCUC | 1.1/4" | 1 | N/A |

Wastes: Slotted Mushroom Brass Basin Clicker Waste - Chrome



| MasterFlow Code | Size (mm) | Bag Qty | Box Qty |
|-----------------|-----------|---------|---------|
| WBSCMSC | 1.1/4" | 1 | N/A |

Wastes: Unslotted Mushroom Brass Basin Clicker Waste - Chrome



| MasterFlow Code | Size (mm) | Bag Qty | Box Qty |
|-----------------|-----------|---------|---------|
| WBSCMUC | 1.1/4" | 1 | N/A |

Wastes: Slotted Swivel Waste Chrome

| MasterFlow Code | Size (mm) | Bag Qty | Box Qty |
|-----------------|-----------|---------|---------|
| WBSSWSC | 1.1/4" | 1 | N/A |

Wastes: Unslotted Swivel Waste Chrome

| MasterFlow Code | Size (mm) | Bag Qty | Box Qty |
|-----------------|-----------|---------|---------|
| WBSSWUC | 1.1/4" | 1 | N/A |

Fittings Specifications

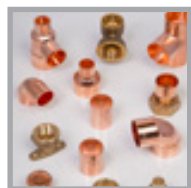

End Feed Fittings109

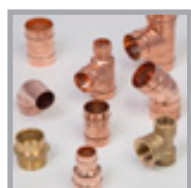

Solder Ring Fittings110

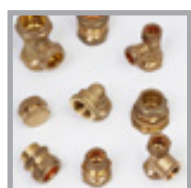

Compression Fittings111

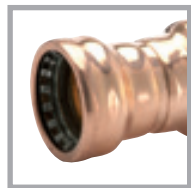

Copper Pushfit Fittings112



WRAS Approved Flexi Tap Connectors.....113

End Feed Fittings



MasterFlow End Feed capillary fittings are available in sizes 8-54mm and are suitable for connecting copper tubes in accordance with EN 1057.

MasterFlow End Feed fittings are designed for solder and brazing applications, with the exception of Union fittings with copper tails, which can only be soft soldered.

Hydraulic working temperatures and pressures based on EN 1254-1 are shown below:

Applications & Technical Information

| | |
|------------------------------------|---|
| Drinking water | Y |
| Sanitary water | Y |
| Heating and chilled water systems | Y |
| Compressed air | Y |
| Gas | Y |
| Available Sizes | 8 -54mm |
| Operating Parameters solder 6-54mm | Water Using Tin Silver 95/5% 25 bar, 0°C to 30°C 25 bar @ 65°C 19 bar @ 95°C 16 bar @ 110°C Using Tin Lead 50/50% or 60/40% 16 bar, 0°C to 30°C 10 bar @ 65°C 7 bar @ 95°C 6 bar @ 110°C Water |
| Operating Parameters brazed 15mm | 35.1 bar, -20°C to 110°C 29.8 bar @ 150°C 15.8 bar @ 200°C |
| Material | Copper and Yellow Brass |

Solder Ring Fittings



A comprehensive range of solder ring fittings.

Features & benefits

- WRAS approved
- Contains lead-free solder complying with EN 29453 and ISO 9453
- Manufactured in accordance with EN 1254-1
- Available in sizes 8mm to 54mm
- Suitable for connecting copper tubes in accordance with EN 1057
- Accurate ring of solder to remove the need for guesswork and to ensure a quick and secure fitting
- Hydraulic working temperatures and pressures based on EN 1254-1
- Covered by manufacturer's warranty

| Size (mm) | Working Pressure (bar) | | | |
|-----------|------------------------|------|------|-------|
| | 0°C - 30°C | 65°C | 95°C | 110°C |
| 8 - 54 | 16 | 10 | 7 | 6 |

Compression Fittings



MasterFlow Compression fittings are especially advantageous in retrofit plumbing schemes, where space is confined and/or the use of heat must be avoided. They are available in 8 - 54mm and are suitable for connecting a wide range of tubes in accordance with EN 1057.

MasterFlow Compression fittings are available in duplex brass and/or dezincification resistant (DZR) brass or dezincification immune red brass. Fittings are also available in chrome plated in accordance with EN 248.

MasterFlow Compression fittings are also compatible with low carbon steel, stainless steel and many types of plastic pipe including cross linked polyethylene (PE-X) and polybutylene (PB) with size compatible outside diameters.

Applications & Technical Information

| | |
|-------------------------------------|---|
| Drinking water | Y |
| Sanitary water | Y |
| Heating and chilled water systems | Y |
| Compressed air | Y |
| LPG and Natural Gas | Y |
| Available Sizes Water | 8-54 mm |
| Available Sizes Gas | 8-28mm (recommendation) |
| Available Sizes Compressed air | 8-28mm |
| Warranty | Backed by full manufacturers product warranty |
| Operating Parameters Water | 8-15, 25 bar @ 0 to 95°C 28, 16 bar @ 0 to 95°C 35-54, 13 bar @ 0 to 95°C |
| Operating Parameters Gas | 8-28, 1 bar @ 30°C |
| Operating Parameters Compressed Air | 8-28, 7 bar @ 30°C |
| Material | Brass, DZR |

Copper Pushfit Fittings



- Suitable for hot and cold drinking water, heating and chilled water systems
- Connects copper tubes in sizes 10, 15, 22 & 28mm
- Designed for tight corners and exposed pipe work
- Fast and easy to use flame free installation
- Maintains electrical continuity on metallic pipe systems
- Conforms to normal operating parameters for metallic tubes: maximum working pressure of 16 bar at 30°C and 7bar 95°C
- Fitting can be recycled at the end of life

Applications & Technical Information

| | |
|-----------------------------------|--|
| Drinking water | Y |
| Sanitary water | Y |
| Heating and chilled water systems | Y |
| Available Sizes | 10, 15, 22, 28 |
| Warranty | 25 Years |
| Operating Parameters | 16 bar @ 0-30°C 10 bar @ 65°C 7 bar @ 95°C |
| Material | Body: Copper or DZR O-Ring: EPDM Grab Ring: Stainless Steel |
| Water / Glycol | 50/50 to -20°C |
| Disconnect and Reuse | x 20 |

Flexi Tap Connectors



- WRAS Approved
- Hot & cold water systems only, not for use on heating installations

| Code | Description | Size | Length (mm) | Bore Dia. (mm) | Maximum Operating Pressure (Bars) | Maximum Operating Temperature (°C) |
|-----------------|---|-------------|-------------|----------------|-----------------------------------|------------------------------------|
| MFLEXMTC1004 | Mi X Fi Mono Flexi Tap Connector | 10 x 1/2" | 300 | 8.5-8.7 | 16 | 80°C |
| MFLEXMTC1015 | Mi X C Mono Flexi Tap Connector | 10 x 15mm | 300 | 8.5-8.7 | 16 | 80°C |
| MFLEXMTC1204 | Mi X Fi Mono Flexi Tap Connector | 12 x 1/2" | 300 | 8.5-8.7 | 16 | 80°C |
| MFLEXMTC1215 | Mi X C Mono Flexi Tap Connector | 12 x 15mm | 300 | 8.5-8.7 | 16 | 80°C |
| MFLEXTC040430 | F x F - Flexi Tap Connector | 1/2" x 1/2" | 300 | 9.5-9.7 | 16 | 80°C |
| MFLEXTC040450 | F x F - Flexi Tap Connector | 1/2" x 1/2" | 500 | 9.5-9.7 | 16 | 80°C |
| MFLEXTC100450 | Mi X Fi Mono Flexi Tap Connector | 10 x 1/2" | 500 | 8.5-8.7 | 16 | 80°C |
| MFLEXTC120450 | Mi X Fi Mono Flexi Tap Connector | 12 x 1/2" | 500 | 8.5-8.7 | 16 | 80°C |
| MFLEXTC150330 | C X Fi Flexi Tap Connector | 15 x 3/8" | 300 | 9.5-9.7 | 16 | 80°C |
| MFLEXTC150415 | C X Fi Flexi Tap Connector | 15 x 1/2" | 150 | 9.5-9.7 | 16 | 80°C |
| MFLEXTC150415V | C X Fi Flexi Tap Connector C/W Iso Valve | 15 x 1/2" | 150 | 9.5-9.7 | 16 | 80°C |
| MFLEXTC150430 | C X Fi Flexi Tap Connector | 15 x 1/2" | 300 | 9.5-9.7 | 16 | 80°C |
| MFLEXTC150430M | C X Fi Flexi Tap Connector Max Bore | 15 x 1/2" | 300 | 13-13.2 | 16 | 80°C |
| MFLEXTC150450 | C X Fi Flexi Tap Connector | 15 x 1/2" | 500 | 9.5-9.7 | 16 | 80°C |
| MFLEXTC150450PF | C X Fi Flexi Tap Connector Pf | 15 x 1/2" | 500 | 9.5-9.7 | 16 | 80°C |
| MFLEXTC150490PF | C X Fi Flexi Tap Connector Pf | 15 x 1/2" | 900 | 9.5-9.7 | 16 | 80°C |
| MFLEXTC1504PF | C X Fi Flexi Tap Connector Pf | 15 x 1/2" | 300 | 9.5-9.7 | 16 | 80°C |
| MFLEXTC1504V | C X Fi Flexi Tap Connector C/W Iso Valve | 15 x 1/2" | 300 | 9.5-9.7 | 16 | 80°C |
| MFLEXTC1504VPF | C X Fi Flexi Tap Connector C/W Iso Valve Pf | 15 x 1/2" | 300 | 9.5-9.7 | 16 | 80°C |
| MFLEXTC150630 | C X Fi Flexi Tap Connector | 15 x 3/4" | 300 | 9.5-9.7 | 16 | 80°C |
| MFLEXTC150650 | C X Fi Flexi Tap Connector | 15 x 3/4" | 500 | 9.5-9.7 | 16 | 80°C |
| MFLEXTC150650PF | Cf Tap Con & Valve Pushfit | 15 x 3/4" | 500 | 9.5-9.7 | 16 | 80°C |
| MFLEXTC150690PF | Cf Tap Con & Valve Pushfit | 15 x 3/4" | 900 | 9.5-9.7 | 16 | 80°C |
| MFLEXTC1506PF | Cf Tap Con & Valve Pushfit | 15 x 3/4" | 300 | 9.5-9.7 | 16 | 80°C |
| MFLEXTC1506V | C X Fi Flexi Tap Connector C/W Iso Valve | 15 x 3/4" | 300 | 9.5-9.7 | 16 | 80°C |
| MFLEXTC1510450V | C X Fi Flexi Tap Connector C/W Iso Valve | 15 x 1/2" | 500 | 9.5-9.7 | 16 | 80°C |
| MFLEXTC1510650V | C X Fi Flexi Tap Connector C/W Iso Valve | 15 x 3/4" | 500 | 9.5-9.7 | 16 | 80°C |
| MFLEXTC151530 | C X C Flexi Tap Connector | 15 x 15mm | 300 | 9.5-9.7 | 16 | 80°C |
| MFLEXTC151530V | C X C Flexi Tap Connector C/W Iso Valve | 15 x 15mm | 300 | 9.5-9.7 | 16 | 80°C |
| MFLEXTC151550 | C X C Flexi Tap Connector | 15 x 15mm | 500 | 9.5-9.7 | 16 | 80°C |
| MFLEXTC151550PF | C X C Flexi Tap Connector Pf | 15 x 15mm | 500 | 9.5-9.7 | 16 | 80°C |
| MFLEXTC151590 | C X C Flexi Tap Connector | 15 x 15mm | 900 | 9.5-9.7 | 16 | 80°C |
| MFLEXTC1515PF | C X C Flexi Tap Connector Pf | 15 x 15mm | 300 | 9.5-9.7 | 16 | 80°C |
| MFLEXTC220630 | C X Fi Flexi Tap Connector | 23 x 3/4" | 300 | 13-13.2 | 16 | 80°C |
| MFLEXTC220650 | C X Fi Flexi Tap Connector | 23 x 3/4" | 500 | 13-13.2 | 16 | 80°C |
| MFLEXTC2206PF | Cf Tap Con & Iso Valve Pushfit | 22 x 3/4" | 300 | 13-13.2 | 16 | 80°C |
| MFLEXTC2206V | Cf Tap Con & Iso Valve | 22 x 3/4" | 300 | 13-13.2 | 16 | 80°C |
| MFLEXTC2206VPF | C X Fi Flexi Tap Connector C/W Iso Valve Pf | 22 x 3/4" | 300 | 13-13.2 | 16 | 80°C |
| MFLEXTC222230 | C X C Flexi Tap Connector | 22 x 22mm | 300 | 13-13.2 | 16 | 80°C |
| MFLEXTC222250 | C X C Flexi Tap Connector | 23 x 22mm | 500 | 13-13.2 | 16 | 80°C |

MASTERFLOW PRODUCTS LIMITED TERMS AND CONDITIONS OF SALE

1 General

All quotations must be given and all contracts must be concluded by Masterflow (Company) in writing, or in electronic form through the Company's Electronic Data Interchange (EDI). These terms and conditions shall apply to all quotations and contracts for the sale or supply of goods (Goods) made between the Company and the recipient of the Goods (Purchaser) unless expressly varied or excluded in writing signed by one of the Company Directors. These terms and conditions and any quotation given constitute the entire agreement between the parties (Contract). If any of these conditions or any part thereof is rendered void or unenforceable by any legislation to which it is subject, it shall be so void and unenforceable to that extent and not further.

2 Acceptance

- 2.1 All orders are subject to the Company's written acknowledgement and are accepted on the understanding that these terms and conditions apply to the exclusion of all other terms and conditions which the Purchaser may purport to apply under any purchase order, confirmation of order or similar document.
- 2.2 Orders accepted cannot be cancelled without the Company's written consent and on terms which will indemnify the Company for all direct, indirect and consequential loss, damage, costs and expenses as a result of such cancellation.
- 2.3 Orders made through the EDI shall only become binding upon acknowledgement of receipt of order given by the Company and these terms and conditions shall apply.

3 Delivery

- 3.1 Time of delivery shall not be of essence and any dates expressed in the Contract or quotation are given subject to this condition. The Company shall not be liable for any direct, indirect or consequential loss, damage costs or expenses incurred or suffered by the Purchaser as a result of any delay in despatch or delivery whatsoever caused.
- 3.2 Delivery of the Goods shall take place:
- where the Company transports the Goods, at the time the Goods are unloaded from the Company's vehicle or any third party carrier at the station, port or location specified by the Purchaser, or
 - where the Purchaser transports the Goods at the Company's premises or other pre-arranged location.

4 Prices

- 4.1 Unless otherwise stated in the Contract, all prices in quotations and contracts are exclusive of VAT and apply to Goods packed in standard packs.
- 4.2 Orders to the value of £100 sterling or more will be supplied carriage paid to any premises of the Purchaser in the United Kingdom. No allowance will be made for carriage costs where Goods are collected by the Purchaser, or his agents from the Company's premises.
- 4.3 The Company reserves the right to impose a Minimum order charge of £25 sterling on any order placed with a value less than £100 sterling to cover Minimum administration and carriage costs to the Purchaser's premises in the UK.
- 4.4 Goods may be supplied by passenger train, special carrier service or air freight at the Customer's request subject to additional charges agreed with the Company.
- 4.5 Where FOB orders are valued at less than £750 sterling the Company reserves the right to impose additional charges for packing and delivery.
- 4.6 The Company reserves the right to refuse orders CFR or CIF to the value of less than £1,500 sterling. All CIF and CFR prices are based on the current freight rates and the Company reserves that right to amend the charges in the event of changes in freight rates at the time of shipment.
- 4.7 All prices are subject to alteration without prior notice and all orders are accepted on the understanding that they will be invoiced at prices ruling at the day of despatch. The Purchaser will pay such prices as so invoiced.
- 4.8 Any matter apart from the supply of Goods such as special packing tests or inspections, samples or other impositions shall be charged extra to the Purchaser.
- 4.9 All quotations made in currencies other than sterling are based on current exchange rates and the Company reserves the right to amend these in the event of changes in the rates of exchange.
- 4.10 All packing specifications are estimated and subject to possible alteration in the event of an order.
- 4.11 The terms FOB, CIF and CFR are as defined by Incoterms 2000 (as amended from time to time).

5 Payment

- 5.1 Unless otherwise agree, payment of the price for the Goods is due in pounds sterling and shall be payable not later than 30 days after the last day of the month in which the Company delivers the Goods. Time for payment is of the essence of the Contract. If payment is not made by the due date the Company reserves the right to suspend deliveries on this or any other contract with the Purchaser.
- 5.2 Where the contract is may be fulfilled in separate instalments deliveries or parts, payment for each such instalment, delivery or part shall be made under sub-clause 5.1 above as if the same constituted a separate contract.
- 5.3 Should the Purchaser fail punctually to comply with the terms of payment, the Company shall be entitled to interest on any amount outstanding from the due date until the actual date of payment at the rate of 4% above the Barclays Bank Base Rate in force from time to time unless otherwise stated by the Company in writing at the time of ordering.

6 Risk and property in the Goods

- 6.1 Risk of damage to or loss of the Goods shall pass to the Purchaser at the time of delivery by the Company or collection by the Purchaser or, if the Purchaser fails to take delivery of the Goods, the time when the Company has tendered delivery of the Goods.
- 6.2 Notwithstanding delivery and passing of risk in the Goods, or any other provision of these conditions, the property in the Goods shall not pass to the Purchaser until the Company has received payment in full of the price of the Goods (in cash or cleared funds) and all other Goods agreed to be sold by the Company to the Purchaser for which payment is due.
- 6.3 Until such time as the property in the Goods passes to the Purchaser, the Purchaser shall, at its own cost, hold the Goods as the Company's fiduciary agent and bailee, and shall keep the Goods separate from those of the Purchaser and third parties and properly stored, protected and insured and identified as the Company's property. The Purchaser shall be entitled to re-sell or use the Goods in the ordinary course of business.
- 6.4 Until such time as the property in the Goods passes to the Purchaser, (and provided the Goods are still in existence and have not been re-sold), the Company shall be entitled at any time to require the Purchaser to deliver up the Goods to the Company and, if the Purchaser fails to do so forthwith, to enter upon any premises of the Purchaser or any third party where the Goods are stored and re-possess the Goods. The Purchaser shall not make any modifications to the Goods or their packaging or alter, remove or tamper with any marks, numbers or other means of identification on or in relation to the Goods.
- 6.5 The Purchaser shall account to the Company for the proceeds of sale or otherwise the Goods whether tangible or intangible, including insurance proceeds and shall keep all such proceeds of sale or otherwise on trust for the Company and hold separate from any monies or property of the Purchaser and third parties and in the case of tangible proceeds properly stored, protected and insured provided that the Purchaser will have no authority to enter into any contract of sale or other contract on behalf of the Company and any such contract shall accordingly be concluded in the name of the Purchaser.
- 6.7 The Purchaser shall not be entitled to pledge or in any way charge by way of security for any indebtedness any of the Goods which remain the property of the Company, but if the Purchaser does so all monies owing by the Purchaser to the Company shall (without prejudice to any other right or remedy of the Company) forthwith become due and payable.

7 Insolvency of the Purchaser

- 7.1 Where any of the following occurs, without prejudice to any other right or remedy available to the Company, the Company shall be entitled to cancel the Contract or suspend any further deliveries under the Contract without any liability to the Purchaser. If any of the Goods have been delivered to the Purchaser but not paid for the price shall become immediately due and payable notwithstanding any previous agreement or arrangement to the contrary:
- the Purchaser makes any agreement or composition with its creditors or if a bankruptcy petition is presented or if the Purchaser enters into liquidation whether compulsorily or voluntarily; or
 - an encumbrancer takes possession, or a receiver is appointed over the whole or any part of the Purchaser's assets or undertaking; or
 - an administrator has been appointed to manage its affairs, business and property or if the Purchaser takes or suffers any similar action in consequence of debt; or
 - the Purchaser ceases or threatens to cease to carry on business, suspends payments of its debts or is unable to pay its debts; or
 - the Company reasonably apprehends that any of the events mentioned above is about to occur in relation to the Purchaser and notifies the Purchaser accordingly; or
 - the Purchaser is subject to any event analogous to (a) or (e) in any other jurisdiction in which the Purchaser operates;
- where any of the events set out in (a) to (f) shall be defined as an Act of Insolvency

8 Undertaking and exclusion of liability

- 8.1 The Company warrants that on delivery and for a period of 365 days from the date of delivery, the Goods shall be of satisfactory quality within the meaning of the Sale of Goods Act 1979. The Purchaser shall give notice to the Company in writing of any breach of this warranty and shall give the Company reasonable opportunity to examine such Goods. The Company shall not be liable for any breach of this warranty if:
- the Purchaser makes any further use of such Goods after giving such notice; or
 - the defect arises because the Purchaser failed to follow the Company's instruction as to the storage, installation, use or maintenance of the Goods; or
 - the Purchaser alters or repairs such Goods without the Company's written consent.
- 8.2 In the event of any Goods (or parts thereof) in place acknowledged by the Company to be defective, the Company shall repair the Goods, or at the Company's option supply free of charge new Goods (or parts thereof) and the Company shall have no further liability in respect of such defective Goods (or parts thereof).
- 8.3 The warranty given in condition 8.1 shall apply to any repaired or replaced Goods provided hereunder for the duration of the unexpired portion of the 365 day period applicable to the Goods for which the repair or replacement has been performed.
- 8.4 Subject as expressly provided in these conditions and except where the Goods are sold to a person dealing as a consumer (within the meaning of the Unfair Contract Terms Act 1977) all warranties, conditions or other terms

which apart from this condition would be implied by statute or common law are excluded to the fullest extent permitted by law. Where the Goods are sold to a person dealing as a consumer (within the meaning of the Unfair Terms Act 1977) the statutory rights of the Purchaser are not affected by these conditions.

- 8.5 Neither the Company nor its officers, employees and agents shall (except in respect of death or personal injury caused by the negligence of the Company its officers, employees or agents and any liability which cannot be excluded under part 1 Consumer Protection Act 1987) be liable to the Purchaser by reason of any representation or implied warranty condition or other terms or any duty at common law, or under the express terms of the Contract, for any injury and/or loss, and/or damage of any kind whatsoever and howsoever arising or arisen whether direct, indirect, consequential or special and howsoever caused (whether occasioned by the negligence of the Company or its officers employees or agents or otherwise and including without limitation any loss arising out of the liability of the Purchaser to any third party by virtue of part 1 Consumer Protection Act 1987) resulting from or arising out of or in connection with the Goods (including without limitation any defect therein and/or any act or omission of the Company in connection therewith, except as expressly provided in these conditions).
- 8.6 In no event will the Company be liable under any terms of or otherwise in connection with the contract for lost profits or any indirect or consequential damages.
- 8.7 The Purchaser shall indemnify the Company in full against any liability whatsoever (but excluding any liability based on the negligence of the Company its officers, employees or agents) which it may incur resulting from any claim made against the Company by a third party in respect of any matter for which liability to the Purchaser is excluded by the foregoing provisions of this condition 8.
- 8.8 Accordingly it shall be for the Purchaser to insure against any liability arising as a result of these conditions (including without limitation the operation of conditions (*) to (9) above).

9 Checking Goods

Unless the Purchaser gives written notice to the Company within 14 days from the date of arrival of the Goods at the Purchaser's premises or the destination agreed by the parties as the case may be that the Goods are not in conformity with the Contract, the Purchaser shall be deemed to have accepted the Goods and shall be bound to make payment thereof on the due date.

10 Special Goods

Where the Company supplies Goods to the special requirement of the Purchaser the specification or description of which is outside the Company's usual range as set out in its catalogues the Company shall be entitled to supply the Purchaser 10% more or less of the quantity of such Goods and to be paid for the quantity actually delivered. Any drawings supplied by the Purchaser shall become the property of the Company. Where part cost dies and tools are charged they are kept for the Purchaser's own use, but they remain the property of the Company and the Purchaser has no property in them. The Company reserves the right to consider obsolete, and to destroy, dies and tools from which no Goods have been ordered for a period of three years.

11 Inspection

If tests are required to the Purchaser's own specification, such tests are to be carried out at the Company's premises and are to be final there, although if desired arrangements can be made for a representative of the Purchaser to observe such tests and inspection.

12 Returns

Goods once despatched may not be returned without the Company's consent in writing. Where such consent is given, credit will only be allowed at the price at which the Goods were originally charged less a Minimum of 20% to cover re-stocking, clerical and other expenses. Goods returned must be in good condition, adequately packed and identified and sent carriage paid. If transport is arranged by the Company either on its own vehicles or carriers the cost will be deducted from the credit.

13 Notification of damage, partial loss etc

- 13.1 If the Goods or part thereof be damaged in transit or having been placed in transit have not been delivered to the Purchaser or as the Purchaser directed in writing:
- damage or partial loss from a consignment must be notified to the Company and the carrier, other than on a delivery document, immediately after delivery and confirmed in writing within 3 days;
 - non-delivery of a consignment must be notified to the Company and the carrier in writing within 14 days of the date of despatch shown on the Company's invoice/advice note, whichever is the earlier, otherwise we reserve the right to charge for the costs ensuing from the delayed investigation;
 - non-delivery of a consignment despatched to a destination outside the United Kingdom must be notified to the Company and the carrier in writing within 60 days of the date of despatch shown on the Company's invoice, otherwise we reserve the right to charge for costs ensuing from delayed investigation;
 - the Company is not responsible for any damage to or loss or non-delivery of the Goods if by reason of the Purchaser's failure to give notice of damage or loss or non-delivery the Company is thereby prevented from recovering compensation for such damage or loss or non-delivery from the carrier or its agent. In the event the Company shall only be liable to pay such compensation as it receives from the carrier;
 - where the Company has arranged marine insurance on behalf of the Purchaser, in the event of loss or damage, the terms and conditions stated on the insurance certificate must be strictly complied with.

14 Indemnity

The Company shall not be liable for and the Purchaser shall indemnify and hold the Company harmless against all claims by any person for infringement or alleged infringement of patents trademarks copyright or registered designs or otherwise arising directly or indirectly in connection with Goods manufactured by or with work done by the Company on Goods in accordance with Purchasers specifications or with the siting or installation of Goods.

15 Health and safety at work

It is the responsibility of the Purchaser to take such steps as are necessary to ensure that appropriate information relevant to the Goods is made available to any person to whom the Purchaser supplies them.

16 Termination

- 16.1 Without prejudice to its other rights, the Company may by giving written notice to the Purchaser elect to determine the contract forthwith on the happening of any of the following events:
- if the Purchaser shall commit a breach of this or any other contract with the Company;
 - if the Purchaser shall commit or be subject to an Act of insolvency (as defined in condition 7);
 - if any sum owing to the Company from the Purchaser on any account whatsoever shall be unpaid after the due date for payment (in which event the Company shall have a general lien for any sum on all or any property of the Purchaser in its possession);
 - if the Purchaser shall refuse to take delivery of or collect any of the Goods in accordance with the terms of the Contract.

17 Descriptive matter

Descriptive matter, illustrations, estimates of performance, dimensions and weights contained in documents issued by the Company are to be regarded as being for guidance only and are not binding on the Company in any way. The Company's policy is one of continuous improvement and the right to change designs at any time without notice is reserved. Claims of compliance with any relevant standards whether printed in catalogues or marked on Goods, are to be interpreted as type test compliance required by those relevant standards. Where any such details are important to the Purchaser the Purchaser should request the Company to confirm them expressly before placing an order.

18 Force Majeure

In the event of the Company being delayed from performing the contract by any cause beyond its reasonable control including (but without limitation) shortage of materials, or power, delays in transit, strikes or lockouts or other industrial disputes, whether at the Company's premises or those of its suppliers, or accidents at the Company's premises, whether or not the same was or might have been foreseen when the contract was concluded, performance by the Company shall be suspended during the period of delay, provided always that if such delays shall exceed 6 months, after the Company or the Purchaser may give written notice terminating the contract as to further deliveries or work.

19 Waiver and set-off

- 19.1 No failure or delay on the part of the Company to exercise any of its rights under the contract shall operate as a waiver thereof nor shall any single or partial exercise of any such right preclude any other or further exercise thereof. Any waiver by the Company of any breach by the Purchaser of any of the Purchaser's obligations under the contract shall not affect the rights of the Company in the event of any further or additional breach or breaches.
- 19.2 Any liability of the Company under the contract shall be subject to and conditional upon the due performance and observance by the Purchaser of all its obligations under these conditions and subject to these conditions the Purchaser shall not be entitled to withhold or delay payment or exercise any right of set-off whatsoever or howsoever arising which might otherwise be available to it.

20 English law

All contracts for sale and these conditions shall in all respects be construed and operate in accordance with English Law and the Purchaser hereby submits to the non-exclusive jurisdiction of the English courts but without prejudice to the right of the Company to bring proceedings in any jurisdiction it thinks fit.

21 Miscellaneous

If any of the foregoing provisions shall be invalid or unenforceable such invalidity of unenforceability shall not affect the remaining provisions.

MasterFlow

THE NAME YOU CAN TRUST

MasterFlow

Astley Park Estate
The Gatehouse
Kennedy Road
Astley
Manchester
M29 7JY

WEB: www.masterflow.uk.com
EMAIL: masterflow@ibpgroup.com

TEL: 0845 600 3060
FAX: 0845 600 3061

The content of this publication is for general information only. It is the user's responsibility to determine suitability of any product, product data and specifications, for the purpose intended and reference should be made to our Technical Department if clarification is required – technical@ibpgroup.com. In the interests of technical development we reserve the right to change specification, design and materials without notice.

MasterFlow Products Ltd products are approved by numerous Standards Authorities and Certification Bodies. This is a representation of the full range from MasterFlow Products Ltd. Trademarks are registered in the United Kingdom and Northern Ireland.