

Product overview

IMPROVING ROBOT FLEXIBILITY

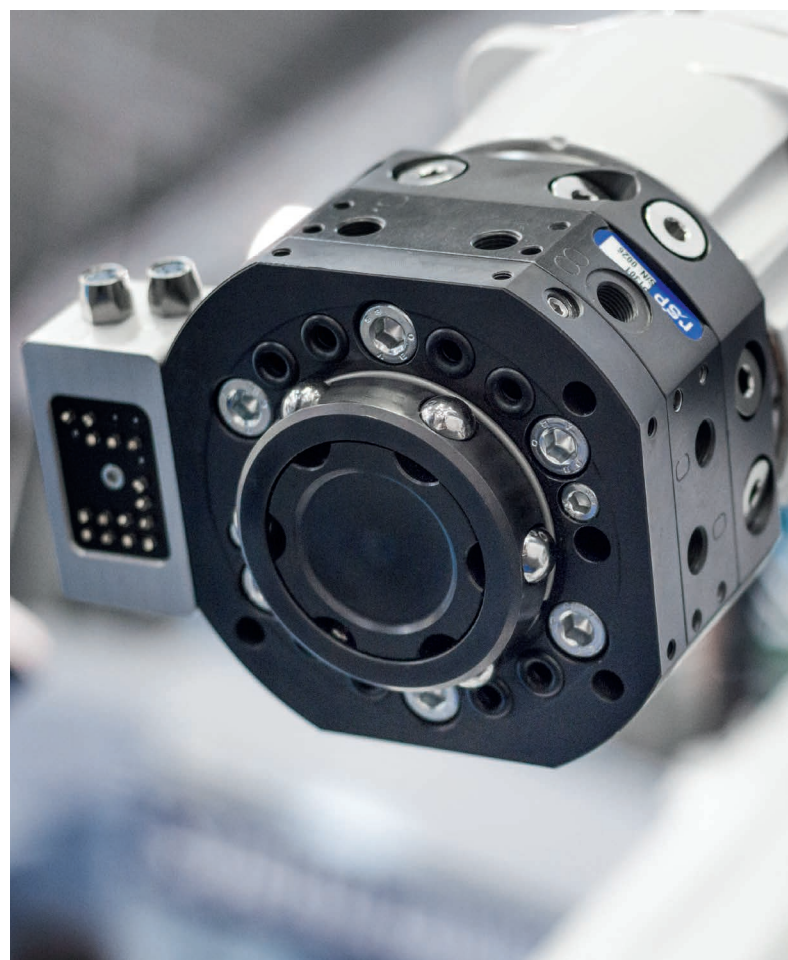

Tool changers | Swivels | Swivel tool changers | Hose packages | Valve units | Grippers | Tool systems | Tool stands

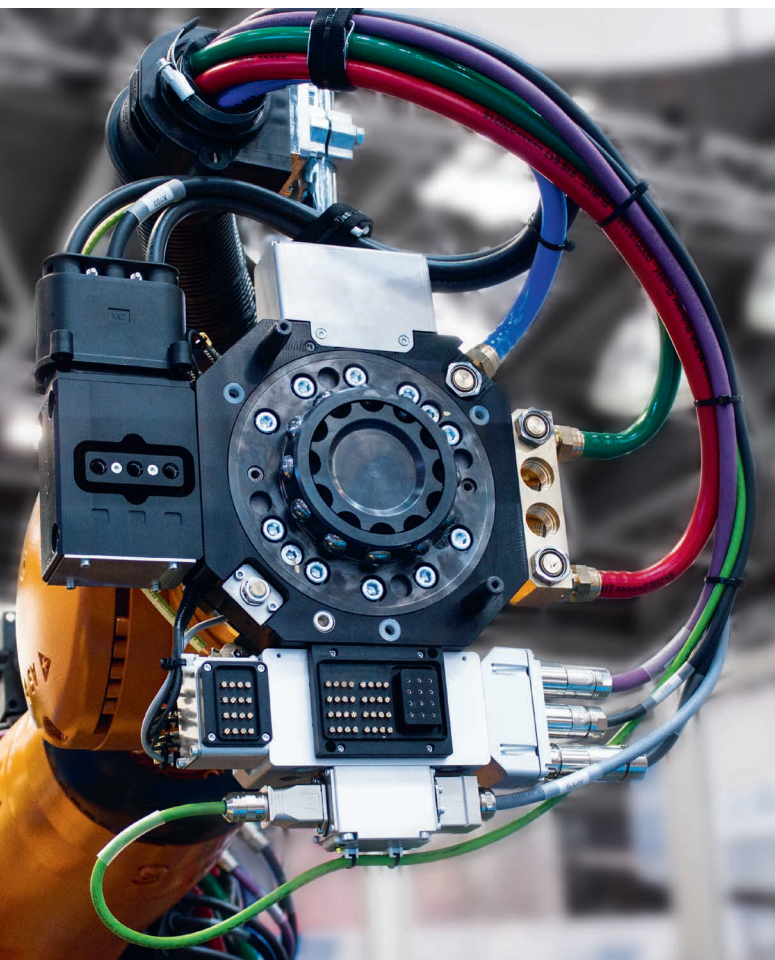
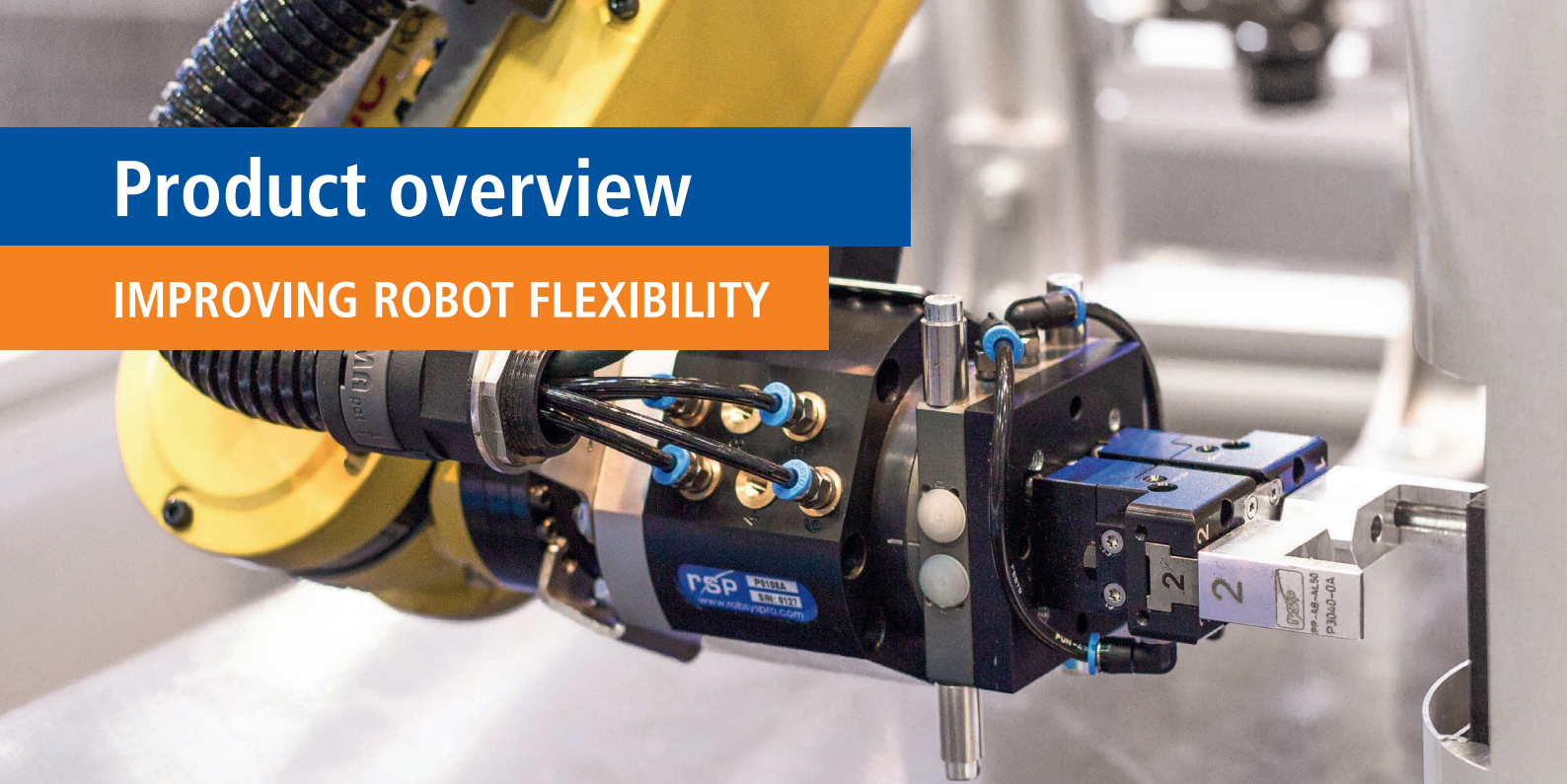

TC - Tool changers

High repeatability with RSP tool changers

RSP has a wide range of automatic tool changers with a load capacity of up to 1,250 kg. The tool changers are robust and can manage continuous changing operations with maintained reliability and safety. Depending on model and options, electrical signals, weld and servo power, data, water and compressed air can be transferred from the robot side to the tool.

- Robust design for high torque applications
- Fast locking → 0.3s
- Absolute positioning repeatability
- Low maintenance and high uptime

RSP also offers manual quick tool changers, MQC, to facilitate easy and quick mounting, dismounting and remounting of larger tools by hand. They have been optimized with respect to weight, compactness and robustness.



Industry leading longevity and positional accuracy

All our tool changers feature the patented locking device, TrueConnect™. It reduces play to the minimum and enables absolute alignment repeatability throughout its lifespan. With its unique design, it does not require exact alignment before docking with different tools. The principle behind the locking mechanism is the uniform distribution of load, obtained by pressing locking balls into spherical grooves in the tool attachment. Industry leading longevity and positional flexibility when docking.

Radially

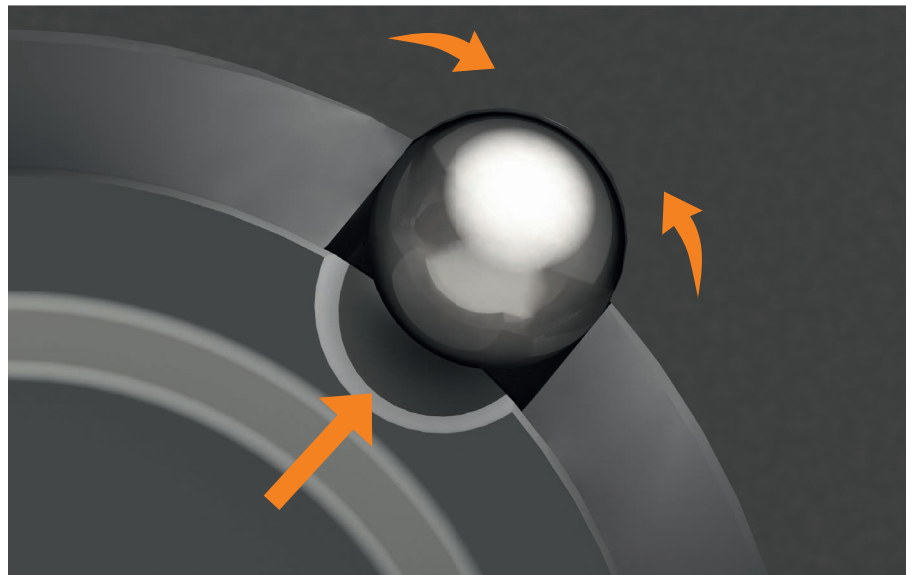

Axially

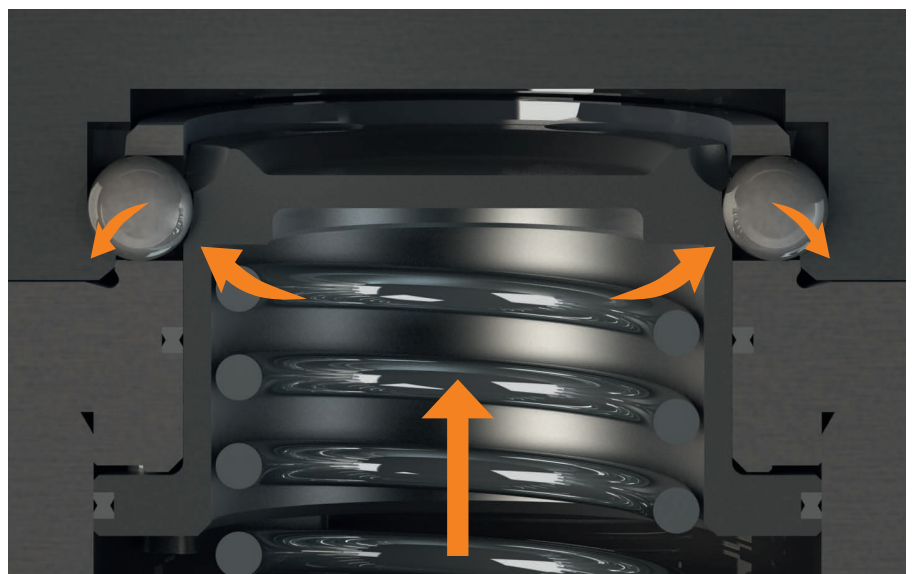

TC range

Compact



- Compact design
- Internal signal transmission
- Minimum of wear of the contact surfaces
- Optimized for material handling and tough environments
- Payload up to 1,000 kg

Modular



- Modular design
- External signals
- Wide range of media modules - simple to customize!
- Payload up to 180 kg

iD - Integrated dressing



- Adapted for hollow wrist robots
- Internal signals
- Plug & Play solution
- No exposed media supply
- Payload up to 60 kg

MQC



- Self-centering design
- Simple fastening - few bolts
- Quick and simple mounting/dismounting of tooling
- Payload up to 300 kg

ModuFlex

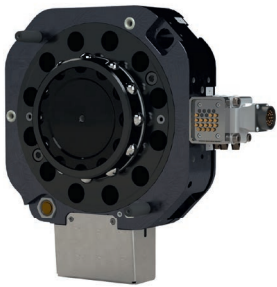

- Modular design
- External signals
- Wide range of media modules - simple to customize!
- Designed to meet bodyshop application demands
- Payload up to 1,250 kg

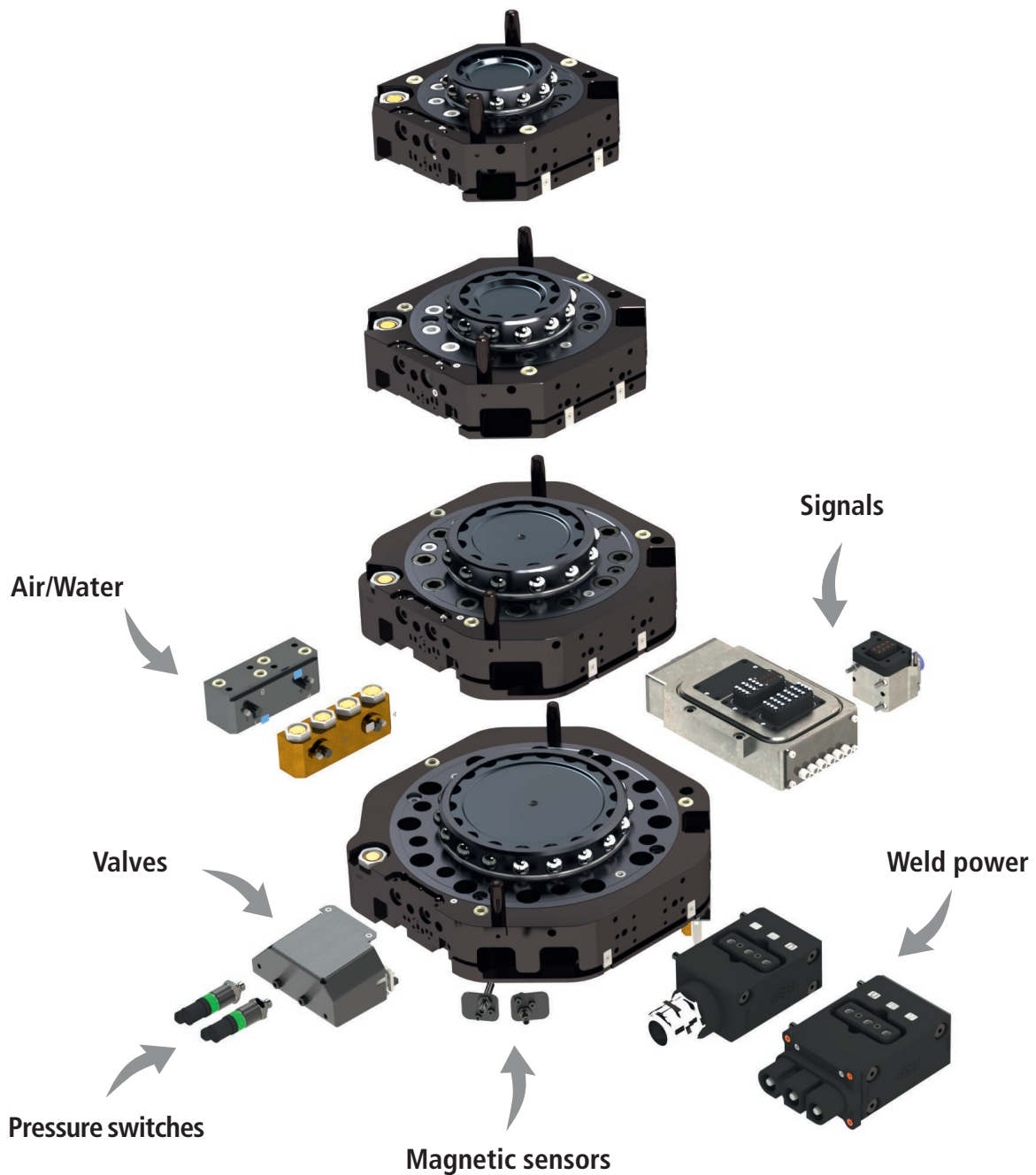

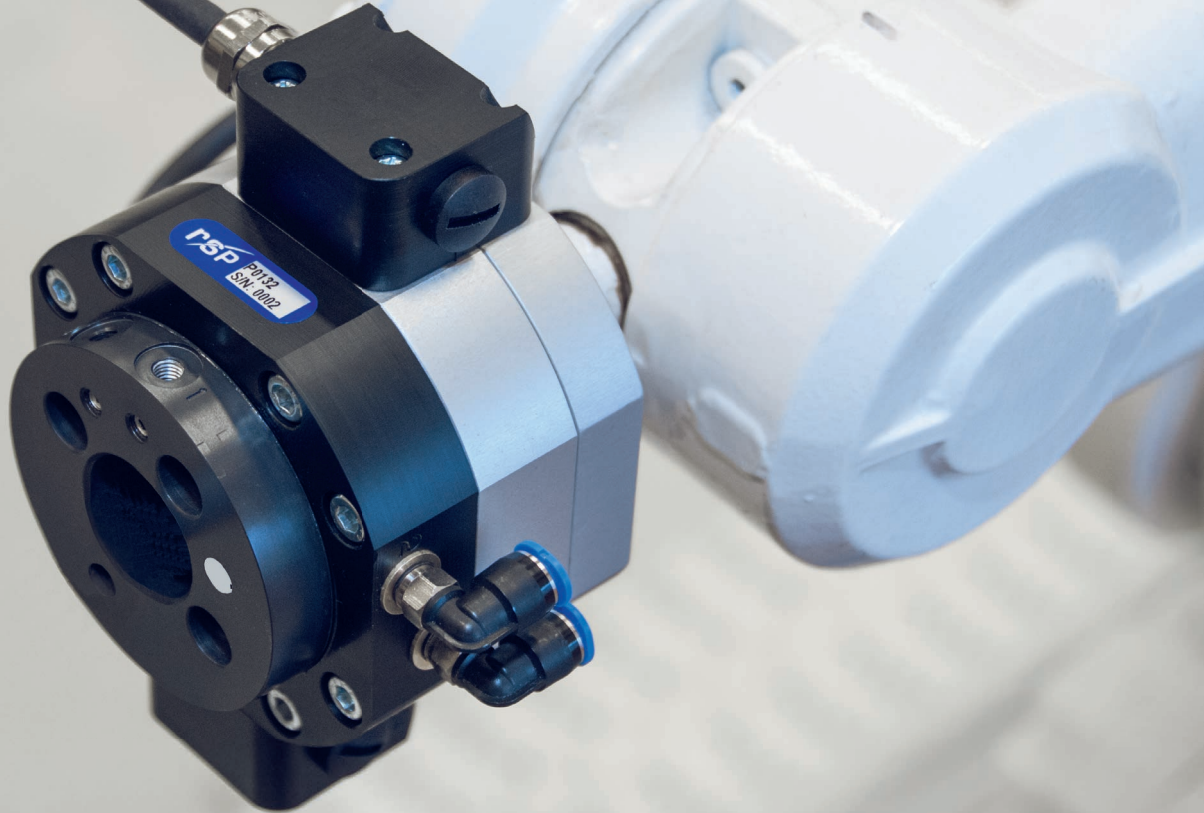

S - Swivels

Spin the 6th axis free from hoses and cables

With Robot System Products' Swivels, axis 6 is allowed to rotate freely. Wear on the hose package decreases, while uptime and productivity increases. If the swivels are used with our hose packages, axis 4 and 5 are also able to rotate unimpeded. The full working range of the robot can be utilized.

- Allows continuous rotation of axis 6
- Up to 350 kg payload
- Reduces hose package interference
- Increases mobility
- Maximizes the hose package lifetime
- 3D simulation control of the upper arm dress package
- Transferable media
 - » Compressed air
 - » Electrical signals
 - » Servo motor power and feedback
 - » Fieldbus signals and data
 - » Cooling water
 - » Weld power

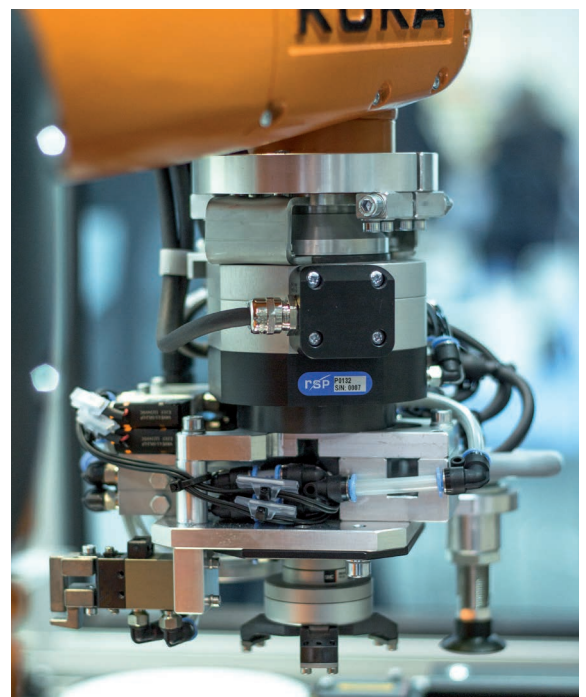

For tough environments

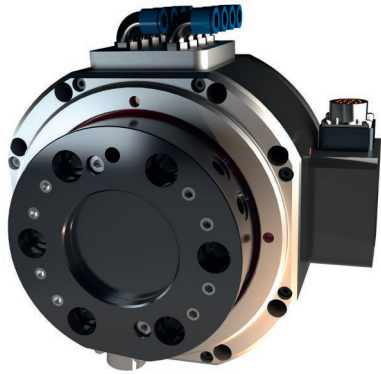

In addition to our standard swivel selection, we offer an enhanced sealing solution specially designed for tough environments.

With swivel

Axis 6 is allowed to rotate freely. Wear on the hose package is drastically decreased.

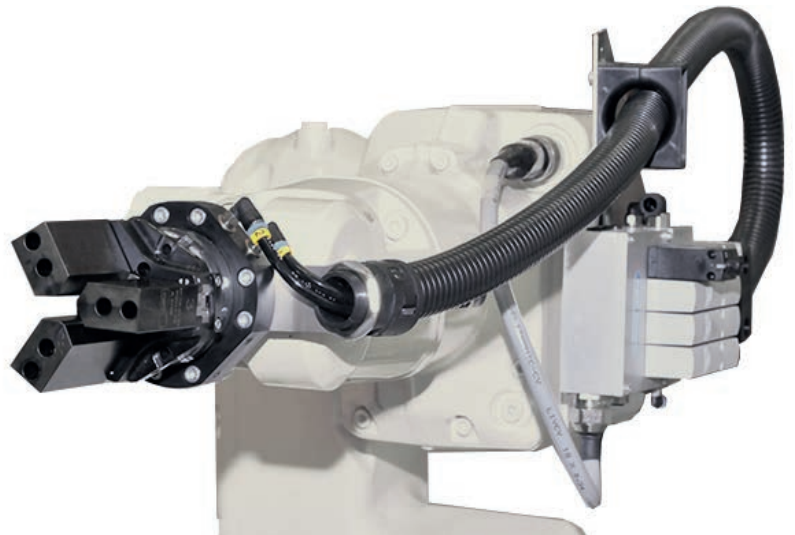

Without swivel

Cable wear increases, with the risk to cause unpredictable downtime and production losses.

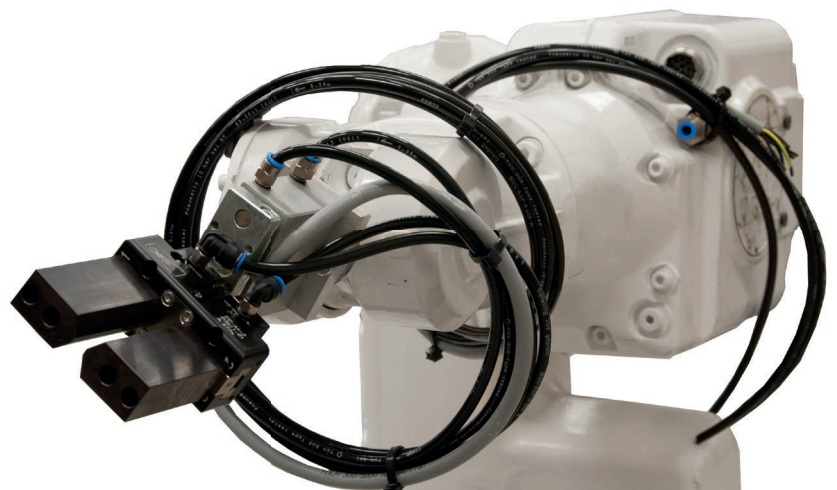

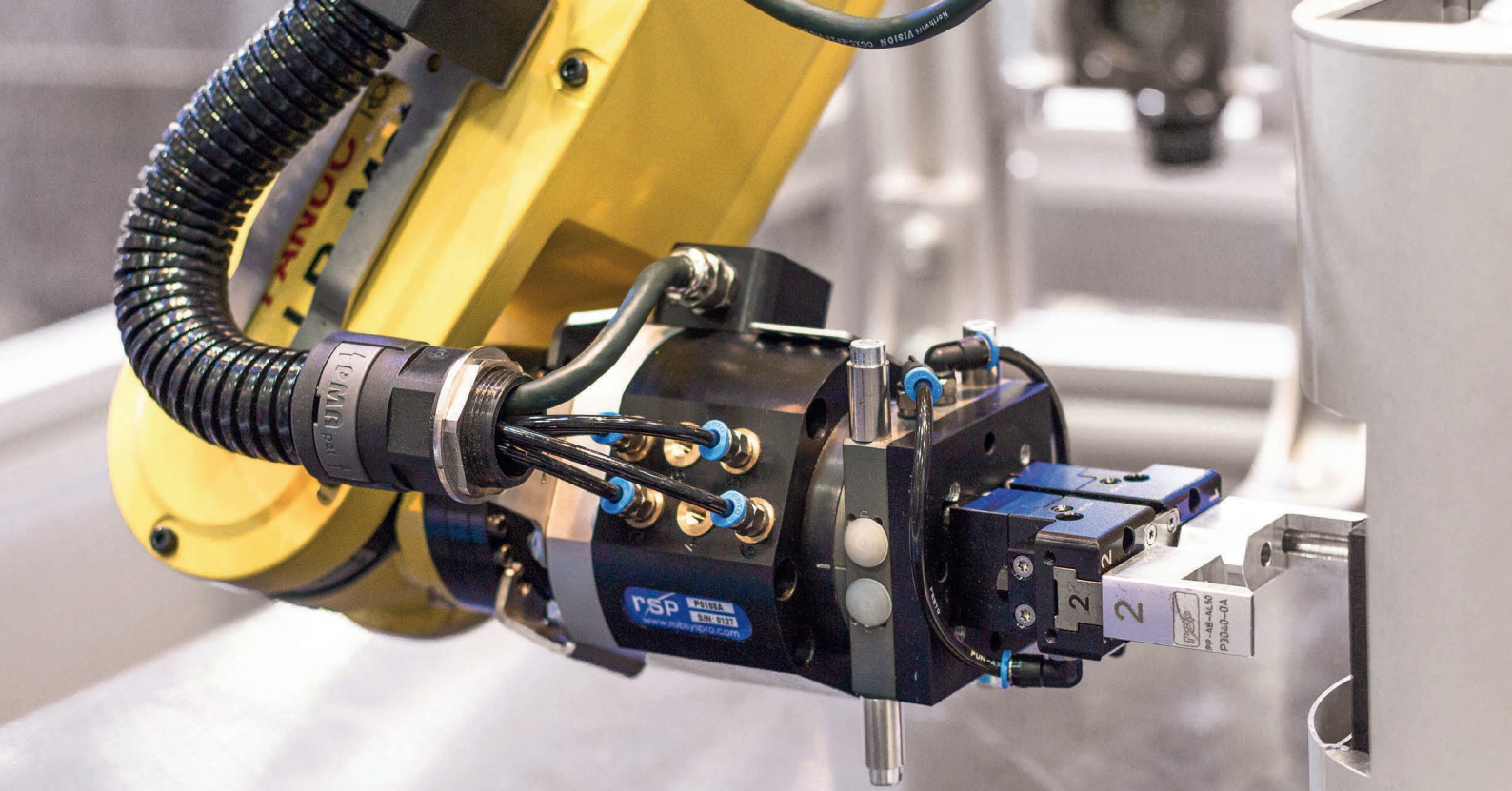

STC - Swivel tool changers

Automatic tool changing combined with free rotation of axis 6

RSP's Swivel tool changer is a unique combination of a swivel and a tool changer. As the sole supplier, RSP offers integrated swivel- and tool changing functions, which combine the free rotation of axis 6 with compactness and minimal extension from the robot's tool plate. RSP's swivel tool changers unite the best of two technologies.

- Compact design
- Allows continuous rotation of axis 6
- Up to 350 kg payload
- Reduces hose package interference
- Increases mobility
- Maximizes the hose package lifetime
- 3D simulation control of the upper arm dress package
- Transferable media
 - » Compressed air
 - » Electrical signals
 - » Servo motor power and feedback
 - » Fieldbus signals and data
 - » Cooling water
 - » Weld power





Swivel



Tool changer



The most compact
Swivel tool changer
on the market

The picture below shows the advantages of using RSP's swivel tool changer compared to a solution where a swivel and a tool changer are mounted together. The STC results in a lower weight and more compact solution.

With swivel tool changer

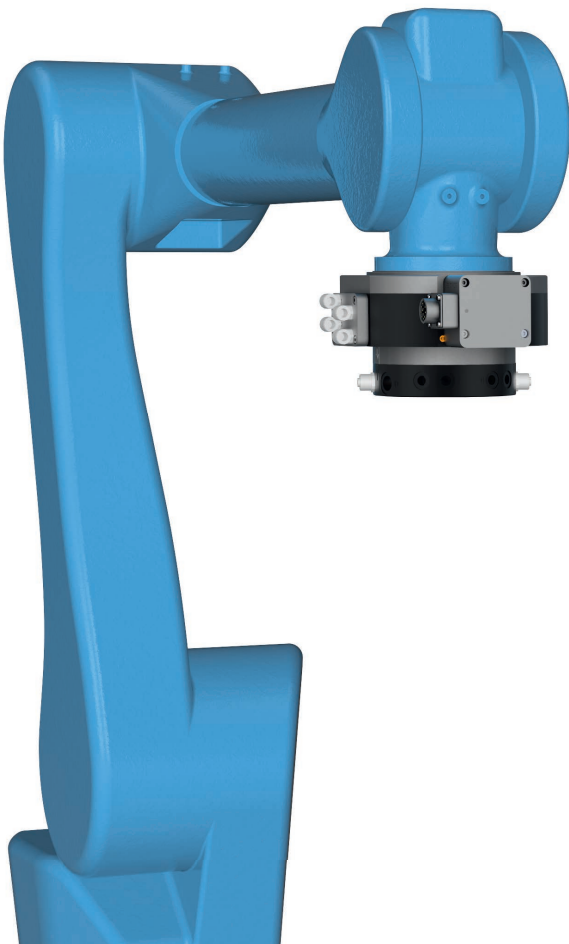

Without swivel tool changer

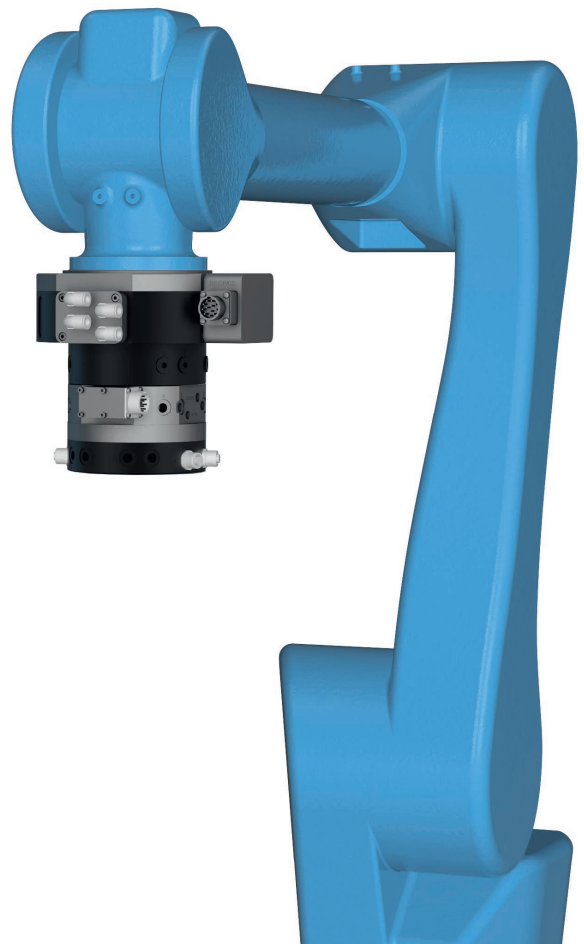



CiRo

Maximize your hose package lifetime with CiRo

Cables and hoses are often the main factors limiting robot movement, frequently causing unpredictable production stops. At the same time, there is significant demand for a compact cell layout and flexible production. CiRo is a cost-effective solution to achieve the flexibility of internal cabling. Hoses and cables for air, signals and power can be selected according to the requirements of the application. Axis 6 can rotate with extended freedom.

- Up to $\pm 250^\circ$ rotation
- Cables and hoses can be selected freely to suit any application
- Extended hose package lifetime
- Quick and easy installation
- High reliability

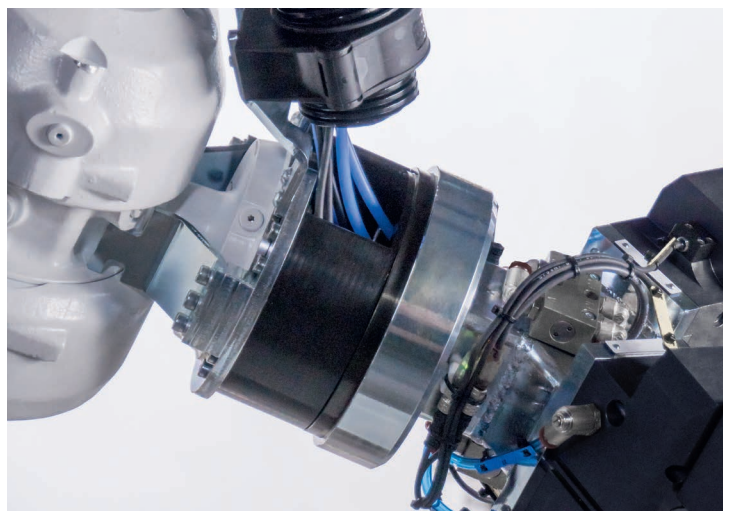

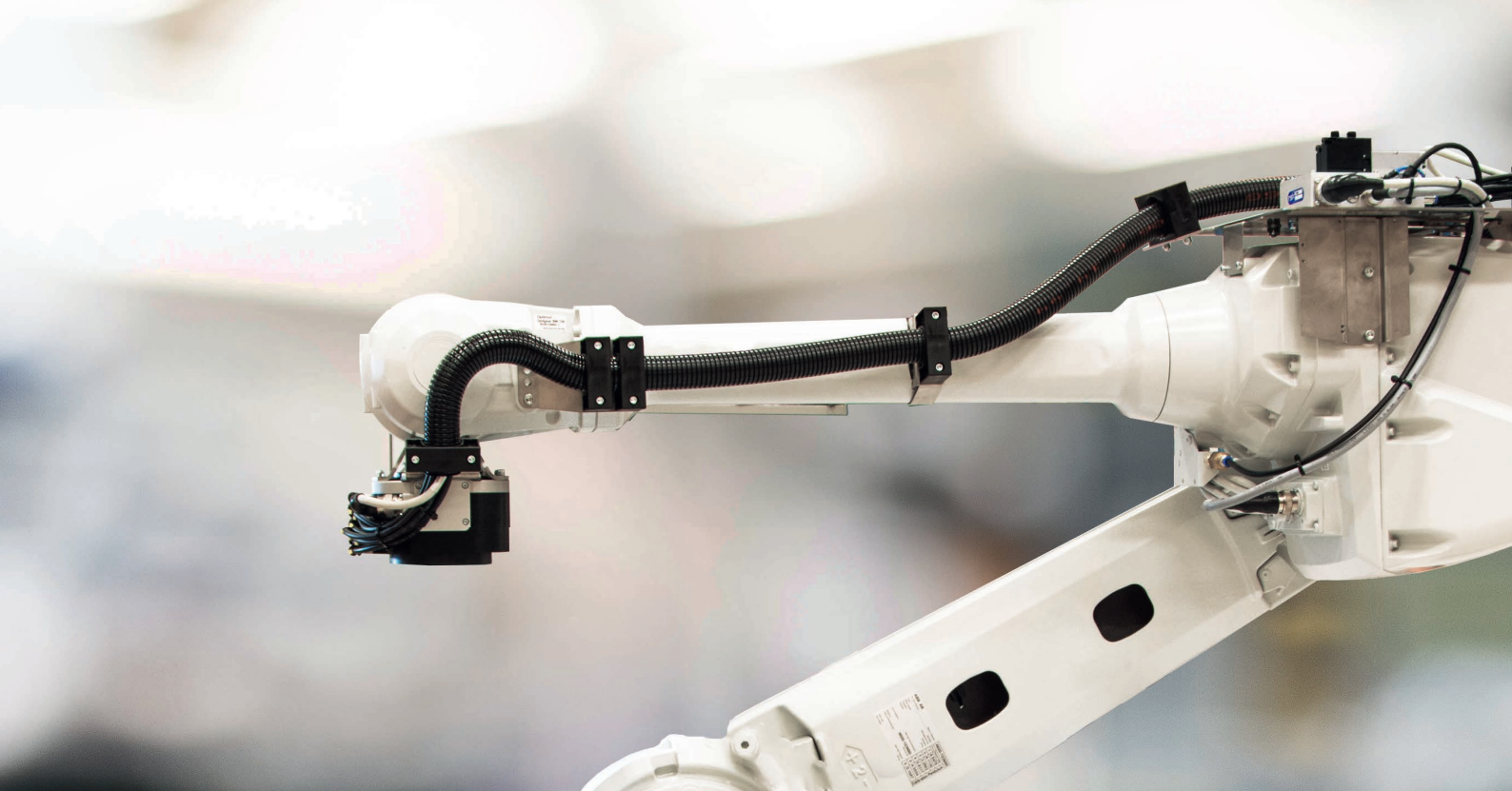

Hose packages

Protect your hoses and cables

The RSP Hose package simplifies the installation of hoses and cables in your robot application. Together with our swivels, the upper arm hose package design allows the robot to move freely and with controlled force to the application hoses and cables. The design of the hose package uses proven technology and ensures that the hoses and cables obtain an extended lifetime.

- Quick and easy installation
- Proven technology
- Modular design
- Bundles and protects hoses and cables
- Reduces downtime
- Large variety to choose from

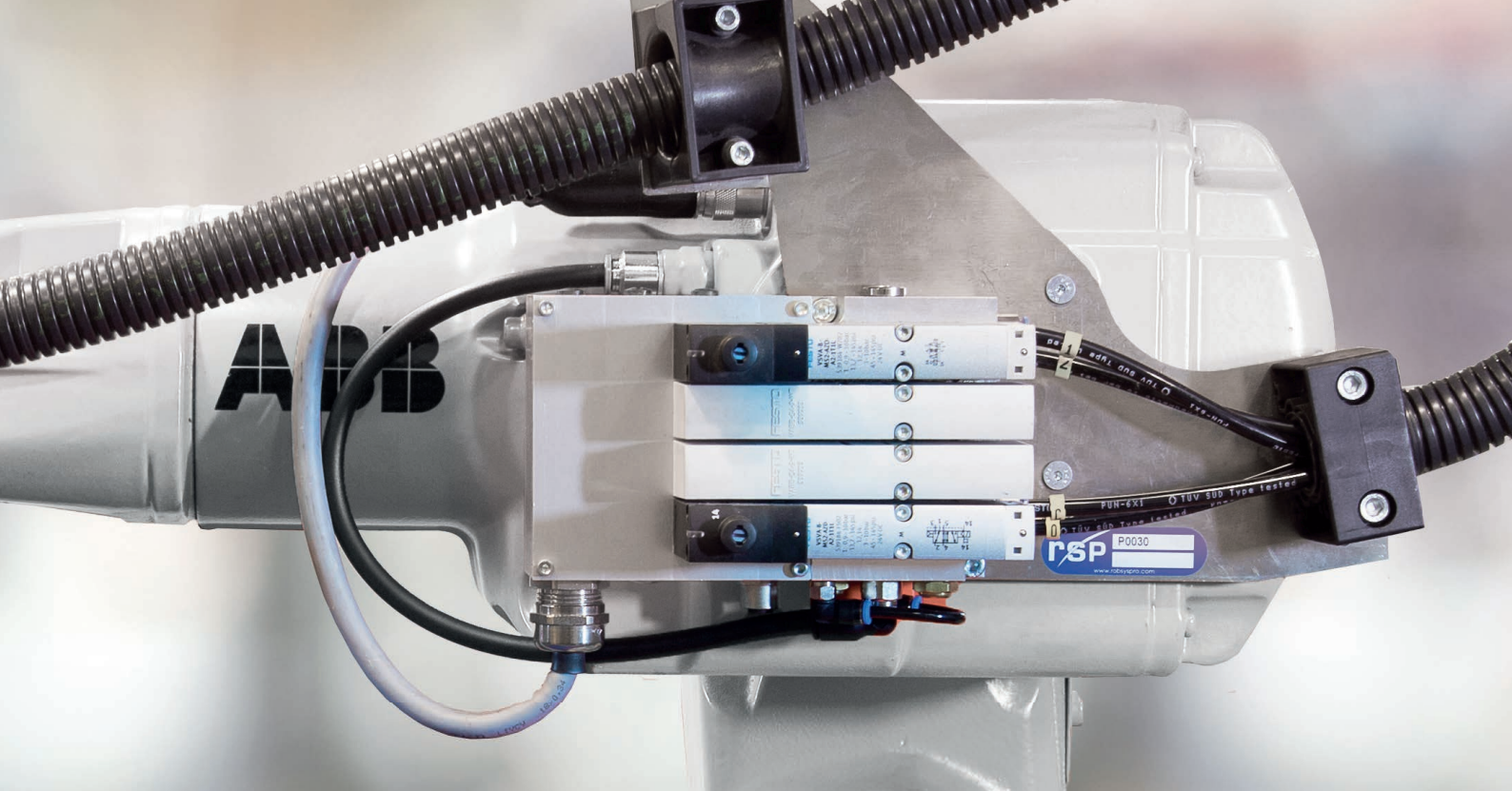

Valve units



Small



Small extended



Large

RSP's Valve units are made for simple mounting

Air and electrical connections are combined into one compact unit controlling the end of arm tooling. When using our valve units together with our tool changers, the air supply to the tooling is automatically shut off during tool changes. Sensor interfaces, field buses, and vacuum modules are available options.

- Plug & Play modules
- Reduced installation time
- Designed for robot mount
- Standard (ISO) valve interface
- Integrated electrical connection box
- Optional tool changing function
- Optional fieldbus interface
- Optional vacuum module



Grippers

Grippers for all kinds of applications

- Two finger parallel grippers
- Parallel long stroke grippers
- Three finger grippers

Options

- Protective covers
- Finger blanks
- Open/Close sensors
- Grip force retainer



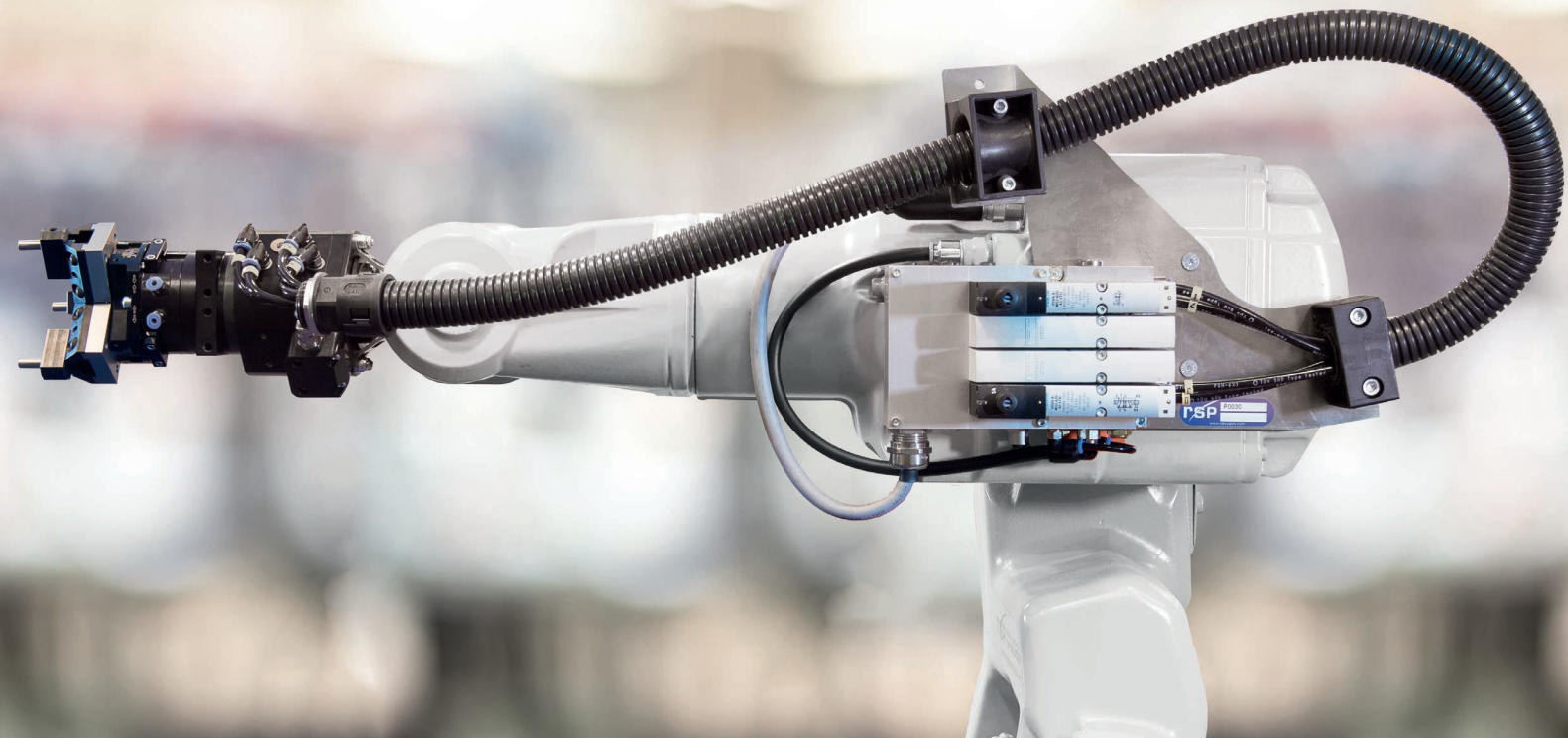

Tool systems

Plug & Play solution

By combining standard elements from our product palette, a complete tool system can be customized for your specific needs. When used together with our swivel tool changer, you benefit from a lean robot suitable for different applications. Spend your time on the application, and not the robot.

- Slim and proven design
- Shortens the installation time
- Low maintenance
- No exposed media supply
- Optimized production uptime

A complete tool system may include

- » Signal cables
- » Air hoses
- » Valve unit
- » Hose package
- » Adaptation kit
- » CiRo
- » Swivel
- » Swivel tool changer
- » Tool attachments





Tool stands

Tailored storage solution

The Robot System Products' Tool stand is a modular unit, easy to install and with a reliable design. RSP offers a variety of tool stand components that can be combined to create a storage solution that meets the requirements of each and every individual robot station.

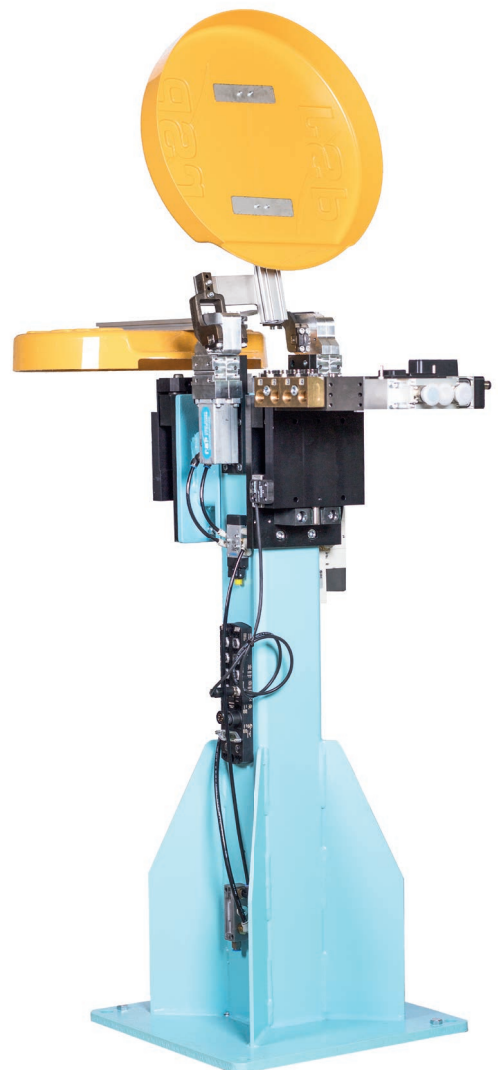

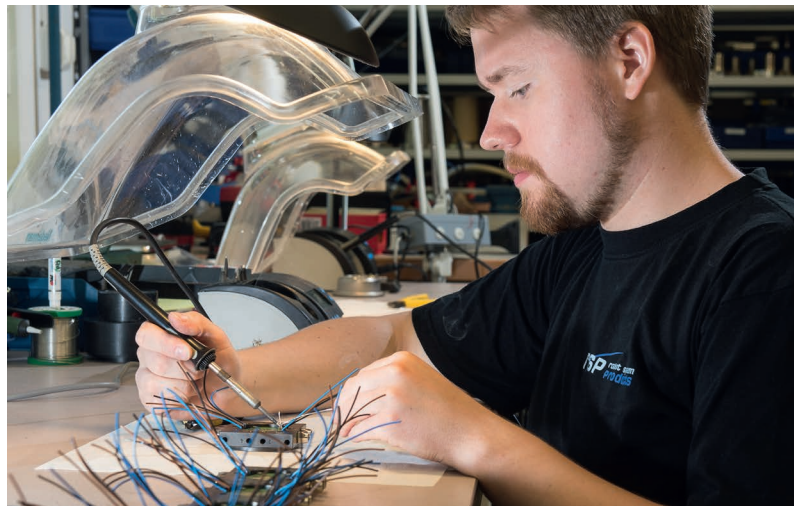
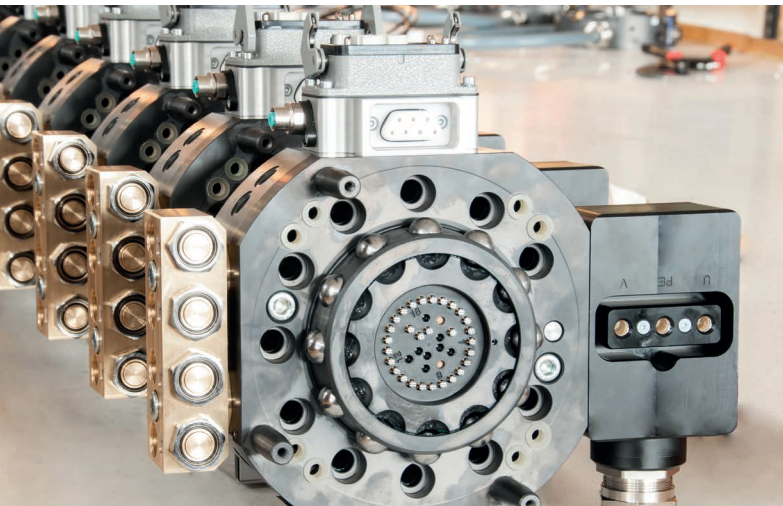
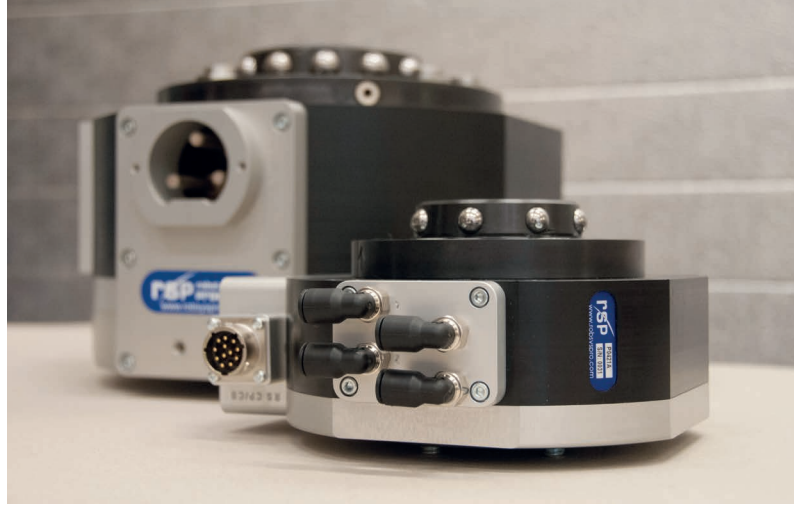

Robot System Products is a global leader in high-performance industrial robot peripheral products. Our expertise is to provide tested and “field proven” robotic system solutions that improve robot flexibility, utilization and uptime. From our position at the forefront of the latest robot models and advances, we offer a full line of documented plug & play robot dress solutions, as well as individual peripheral items that work with all major robot brands and models.

By continuously exploring emerging technologies, RSP designs, validates, manufactures and delivers solutions with engineered advantages that are proven to endure millions of duty cycles.

IMPROVING ROBOT FLEXIBILITY