

Machine Protection Door Albany RP300

ASSA ABLOY

ASSA ABLOY Entrance Systems

The global leader in
door opening solutions



Albany RP300

- Rapid opening and closing ensures short cycle times up to 5 cycles per minute
- High reliability even after years of high numbers of cycles
- Safety limit switches according to EN ISO 13849-1 and EN 62061
- Doors conform to EN ISO 12100 and EN ISO 14119
- Versions conforming to various factory standards are possible
- Type tested machine protection door with fabric door blade

DOOR DESIGN

The side frames and the top roll cover are made of aluminum profiles.

The front cover side frame can easily be removed and allows easy access for inspection and maintenance.

The motor cover is made of a steel plate painted in aluminum color.

WINDOWS

For process monitoring when the door is closed, various window variants are optionally available. On PVC curtains with colored reinforcement strips, there are large viewing areas. For all other variants of curtains, optional horizontal or vertical windows are integrated in the door curtain. Also anti-UV windows conform to EN 1598 for window applications.

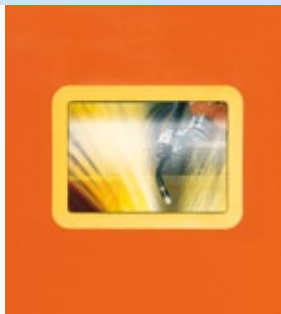

DOOR CURTAIN

Depending on the application, various door curtains and colors are available: from partially transparent PVC curtains with colored reinforcement stripes with a high degree of transparency to highly rigid RollTex® and NomaTex®.

Colors standard of the reinforcement stripes are blue. As Option: Orange, grey, yellow, red, white, black.

All door curtains are silicon-free.

Side-mounted wind tabs reduce inward bending of the door blade.

RollTex® according to TRAV (Technical rules for use of anti-fall guard vitrification)

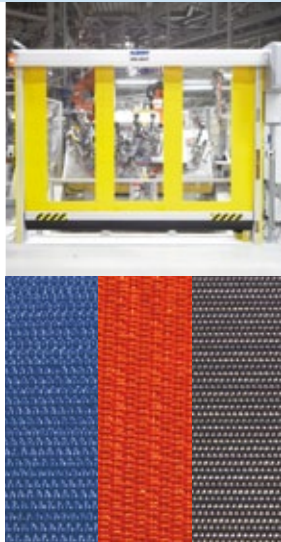

SAFETY FEATURES

The bottom profile is monitored by an electrical safety contact edge. A door line photocell also prevents the door from closing when objects are interfering. As option the door can be equipped with a pre-running photocell in combination with control system Albany MCC.



INTEGRATED CABLE CHAIN

Integrated cable chain guides cables for pre-running photocell or electrical safety contact edge inside the side frame.





ALBANY
RISA ABLOY



SAFETY LIMIT SWITCH INTEGRATED IN SIDE FRAME

For the indication "door safely closed", safety limit switches according to PL d/Kat. 3 and PL e/Kat. 4 (EN ISO 13849-1), SIL 3 (EN 62061) are integrated in the side frame. Delivered with safety monitoring module as standard.

Optional evaluation by safety systems of the machine (version without safety monitoring module).

Due to the use of safety limit switches, machine protection doors cannot be equipped with a knock-out mechanism.



MOTOR COVER AND TOP ROLL COVER

Motor cover made of steel plate painted in aluminum color. Top roll cover made of aluminum. For doors of height < 2300 mm the use of top roll cover is required according to standard EN 13241-1.



MOTOR POSITION

Motor can be mounted right- or lefthand side. Motor position can be chosen in step of 45°. A chain drive is available as option in case of space limitations.



CONTROL SYSTEM

Depending on the application there are 2 control systems which offer a broad spectrum of speeds, power supplies and options for connecting control and safety devices.

Standard: Albany ACS 50,
Option: frequency converter control Albany MCC

On request the door can also be delivered without control system. Extension box: Space saving extension box for Albany MCC allows mounting of interface card or safety monitoring module for safety limit switches.



CONTROL UNIT

Option: The display unit with its user-friendly graphic display and foil keypad.



FLOOR MOUNTING BRACKETS

The door can be mounted freestanding on floor with optional mounting brackets. Levelling screws allow adjustment by uneven floor.



Machine Protection Door **Albany RP300**

ADVANTAGES OF ALBANY RP300

The new generation of Albany machine protection doors offers significant improvements:

- Service friendly: Two-pieced aluminum side frames offer easy access for inspection and maintenance.
- Pre-running photocell: in combination with control system Albany MCC a pre-running photocell is available as option. It provides more comfort and higher closing speed.
- Integrated cable chain: The cables of the electrical safety contact edge and pre-running photocell are guided in cable chains inside the side frame.
- Pluggable cables in the cable chain.
- Drive unit: A chain drive is available as option in case of space limitations.
- Short cycle times: up to 5 cycles per minute is possible. Thanks to its design and small number of parts the Albany RP300 is rugged, reliable and easy to install. It allows short cycle times and can be installed in machines, in production lines and safety fences. The roller door can be installed at short distance from the machine due to its stable, wind load resistant door curtains, which also protect against direct pressure.

DESIGN

The side frames are made of two aluminum profiles. The front cover can easily be removed and allows easy access for inspection and maintenance. Integrated safety limit switches connect the door with the machine. As an option, transparent covers in front of the safety limit switches allows easy inspection of the switches.

DOOR CURTAIN

Various designs and colors are available depending on the application (see table). For use in welding systems we recommend the use of RollTex® or NomaTex® curtains to protect against sparks. Optional anti-UV welding windows that conform to EN 1598 are also available. Side-mounted wind tabs reduce inward bending of the door blade.

DRIVE UNIT

Gear motor with drop down safety gearbox, mounted on the right or left side of the door position, can be varied in steps of 45°. Standard placement vertically downwards.

CONTROL SYSTEM

Depending on the application there are 2 control systems (Albany ACS 50/Albany MCC) which offer a broad spectrum of speeds, power supplies and options for connecting control and safety devices. On request the door can also be delivered without control system.

LINKING WITH THE MACHINE

The in- and outputs of the door control unit can be linked directly with the MCC (potential, 24 V DC) or alternatively in case of the ACS 50 and a potentially-free MCC with the machine's control unit. As standard the following signals are available:

- 2 potential-free safety contacts, when the door is closed (safety limit switch)
- 1 output or potential-free signal, when the door is open
- 1 output or potential-free signal when the door is closed
- 1 output or potential-free signal for faults

MANUAL ACTIVATION

During a power failure the door can be opened manually using a hand crank.

SAFETY FEATURES

This door is designed according to the regulations of the Workplace Directive of the UVV as well as the harmonized CE Guidelines including the EN 13241-1 and 98/37/EG.

INDICATION OF RISK

The security of the door is designed for normal use for vehicles in industrial environment corresponding to the harmonized CE-Guidelines. Next to this, special environmental conditions may have impact on the right choice of doortype. In case of any doubt, please contact our sales engineer to receive consulting in your application.

TECHNICAL DATA

Door dimension mm (DW min./max.) (DH min./max.)	750 / 4000 mm 750 / 3500 mm
Opening direction	vertical
Covers Top roll cover Motor cover	• ¹⁾ •

Surface	
Side frame	Aluminium
Bottom profile	Aluminium
Top roll	Aluminium

Door curtain (alternative)	RollTex® Plus*	RollTex® Original*	NomaTex® /**	PVC with colored reinforcement strips
Blue	•	•	•	✓
Orange	•	•	•	•
Grey	•	•	•	•
Yellow			•	•
Red			•	•
White				•
Black				•
Wind tabs	✓			

*optional with window /**optional with vision panels

RollTex® according to TRAV (Technical rules for use of anti-fall guard vitrification)

Control system / Drive unit	
Drive unit	electrical
Motor power	0,75 kW
Chain drive	•
Control systems	• Albany ACS 50 / Albany MCC
UL-Version 	•

Safety	
Electrical safety contact edge	✓
Door line photocell	✓
Pre-running photocell (only in combination with control system Albany MCC, door line photocell is optional)	•
Drop down protection in drive unit	✓

Speed (m/s)	Albany ACS 50	Albany MCC
Open/close up to max.	1,0 / 1,0	2,4 / 1,3
Open/close up to max. with Albany MCC and pre-running photocell		2,4 / 1,8
Fuse protection	10 A ²⁾	10 A ³⁾
Typical cycle number/minute 3L(N)/PE/220/230/380/400/415V; 50Hz 3L(N)/PE/380/400/415/440/480V; 50/60Hz UL: 3L(N)/PE/230/460/480; 60Hz	max. 1 ✓ ⁴⁾	max. 5* ✓ ⁵⁾
Control voltage	24 V DC	24 V DC
Protection	IP 55	IP 55

• Option ✓ Standard *) Specific number of cycles on request

1) For doors of height < 2300 mm the use of top roll cover is required according to standard EN 13241-1.

2) 16 A at 220/230 V

3) 10 A recommended, 16 A max.

4) Transformer necessary for 440/480/500 V

5) Transformer necessary for 220/230/500 V

General Drawing Albany RP300

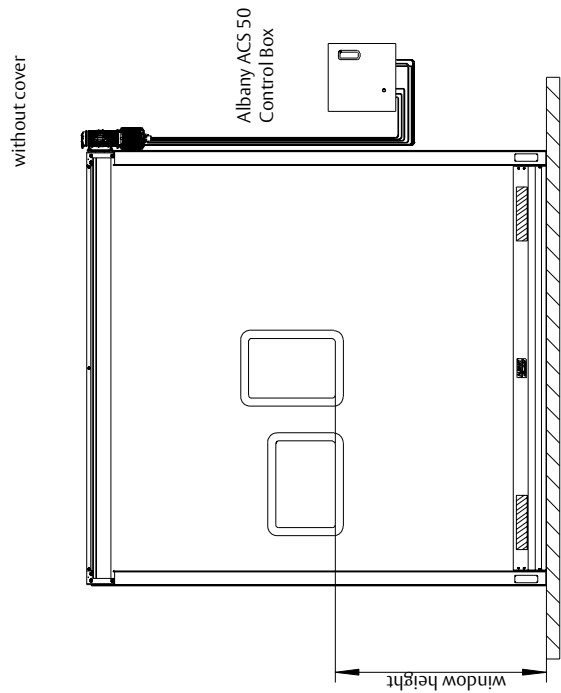
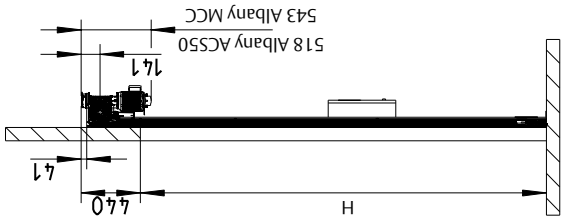
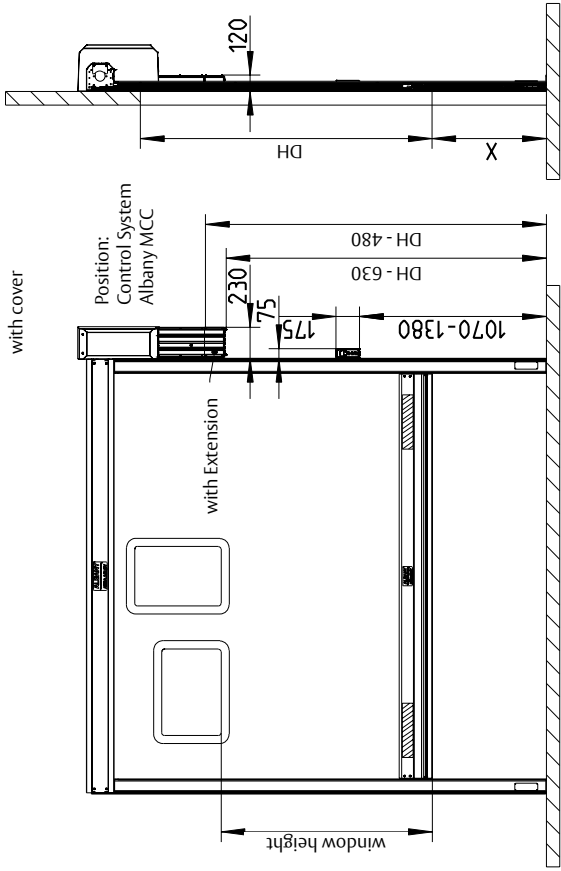

Option X-Level
Door does not close to floor, but down to X-Level

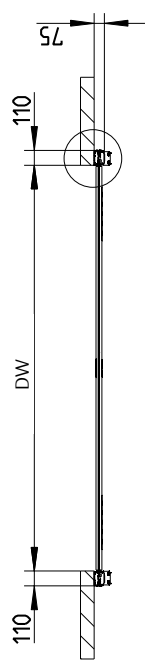
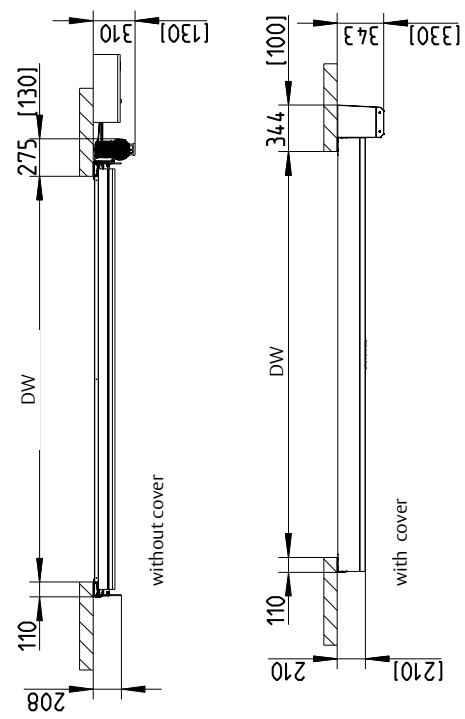
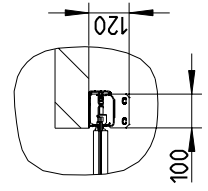
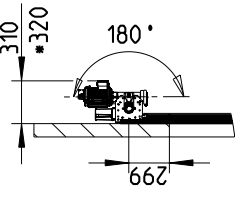
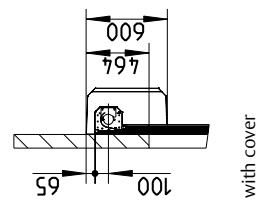
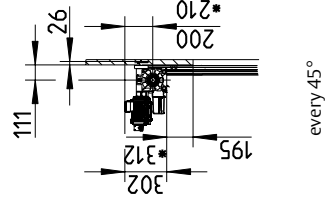
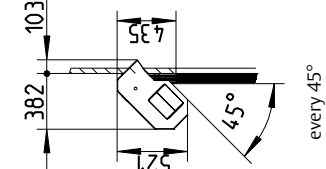
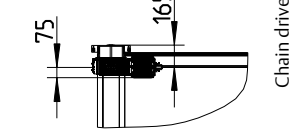
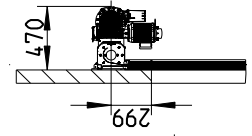
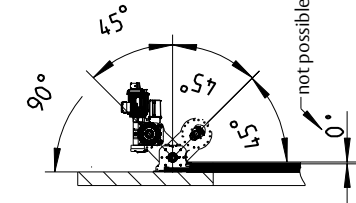

drive unit- and chain drive position not drawn at request

Tolerance ± 3 mm (for all dimensions)

Dimensions in [] = clearance for installation

ASSA ABLOY Entrance Systems is a leading supplier of entrance automation solutions for efficient flow of goods and people. With our globally recognized product brands Besam, Crawford, Megadoor and Albany, we offer products and services dedicated to satisfying end-user needs for safe, secure, convenient and sustainable operations.

ASSA ABLOY Entrance Systems is a division within ASSA ABLOY.

ASSA ABLOY

assaabloyentrance.com



ASSA ABLOY Entrance Systems
High Performance Door Solutions

Tel: +44 (0)333 006 3443
info.uk.aaes@assaabloy.com
www.assaabloyentrance.co.uk

Follow us:



Please enter ASSA ABLOY Entrance
in the channel's search field.