

Temperature sensors and accessories for heat and cooling measurement points

Applications

Temperature sensors are metrological components for heat or cold measuring points. They are used in pairs and measure the flow and return temperature of the heating or cooling system. The difference between the temperatures is used to measure energy consumption.



Features

- A wide range of platinum resistance temperature sensors (as cable or head sensors) in different lengths for direct or sensor pocket mounting.
- With Pt 100 or Pt 500 temperature sensors
- Type approvals according to 2004/22/EC and PTB K7.2 (cooling, combined heating and cooling)
- Matching accessories for direct mounting in the heating or cooling medium
- Customised sensor pocket in various sizes

Benefits

- Matching hot and cold measurement components from Aquametro ensuring high accuracy over long periods of time.
- Low inventory management with the same temperature sensors used for direct or sensor pocket measurement (DS/PSC)

DS/PSC Temperature sensors



Description

- Cable temperature sensors for direct (Direct Short) and pocket (Pocket Short Cable) mounting with Pt 100 and Pt 500, sensor diameter 5 mm, sensor length 45 mm
- Brass sensor pockets
- Ball valves for temperature sensors
- T-piece adapter
- Universally applicable for measuring heat or cold (Type approvals according to 2004/22/EC (MID) and PTB K7.2 (cooling))

Applications

- Recommended for piping up to DN 50 for direct and pocket mounting
- Interchangeable, e.g. for Aquametro meters for piping up to DN 50 mm
- For pipe widths of up to and including DN 25 (1" R), the temperature sensor should be fitted directly in the heating or cooling systems for new systems. In some countries (e.g. Germany), this is set out in the laws on verification, please check the relevant national regulations. For nominal pipe widths of DN 15 (1/2" R) to DN 40 (1 1/2" R), appropriate ball valves with temperature sensor sockets or T-piece adapters are available (see next page).

Note

- There must be mounting symmetrically of both temperature sensors, i.e. both sensors must be identically mounted, e.g. both in ball valves (and not one sensor in a pocket and the other directly mounted in the ball valve or T-piece).
- For direct installing of temperature sensors, only matching T-pieces are to be used. This ensures that no unnecessary measurement errors occur due to unequal immersion depths.

Technical data

	Sensor type	Two-wire connection, Pt 100 and Pt 500
	Protective tube	Stainless steel
	Temperature range	0 to 150 °C
	Connector	Silicon
	Matched pairs	at 10 °C, 65 °C, 120 °C
	Tolerance class to IEC 751	Class B
	Diameter of protective tube (1)	5 mm
	Material of protective tube	1.4571
	Length of sensor (2)	45 mm
	Immersion depth with direct mounting	≈ 27.5 mm
	Connection wire terminals	Terminal sleeves to DIN 46 228 Part 4
	Connection wire lengths (3)	approx. 2'500 mm
	Type approval	according to 2004/22/EC (MID) and PTB K7.2 (cooling)
	Permissible range for ΔT	3... 150 K

Part	Description	Quantity and packaging	Art. No.
DS/PSC 500/45/2.5 m CE M/D cold	Pair of cable sensors Pt 500, sensor length 45 mm, connecting cable 2.5 m	Paired, bag-packed, with screw adapters for direct mounting and installation instructions	80579
DS/PSC 100/45/2.5 m CE M/D cold	Pair of cable sensors Pt 100, sensor length 45 mm, connecting cable 2.5 m	Paired, bag-packed, with screw adapters for direct mounting and installation instructions	80580

Accessories for DS/PSC temperature sensors

Direct mounting

Ball valve with CEN sensor holder (M10x1) for temperature sensor

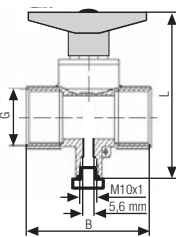
	Thread	Internal thread G 1/2", G 3/4", G 1", G 1 1/4" or G 1 1/2"				
	Temperature sensor socket	M10x1 to EN 1434				
	Material	Nickel-plated brass				
	Maximum media temperature	150 °C				
	Pressure rating	PN 16				
	Dimensions	(G)	G 1/2"	G 3/4"	G 1"	G 1 1/4"
	(L)	72 mm	73 mm	84 mm	122 mm	139 mm
	(B)	47 mm	53 mm	66 mm	87 mm	98 mm

Part	Description	Quantity and packaging	Art. No.
KGH ISO 228 M10x1 IG 1/2"	Ball valve 1/2" for direct mounting of sensor	Loose with locking top	2505
KGH ISO 228 M10x1 IG 3/4"	Ball valve 3/4" for direct mounting of sensor	Loose with locking top	2504
KGH ISO 228 M10x1 IG 1"	Ball valve 1" for direct mounting of sensor	Loose with locking top	2507
KGH ISO 228 M10x1 IG 1 1/4"	Ball valve 1 1/4" for direct mounting of sensor	Loose with locking top	80534
KGH ISO 228 M10x1 IG 1 1/2"	Ball valve 1 1/2" for direct mounting of sensor	Loose with locking top	80535

Also required to fit temperature sensor:

Mounting kit	80205
--------------	-------

T-piece adapter with CEN sensor holder (M10x1) for temperature sensor, mounting in the T-piece

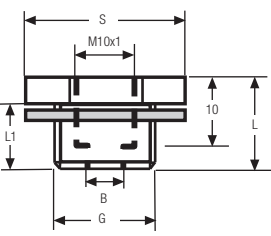
	Thread	External thread G 3/8", G 1/2", G 3/4" or G 1"				
	Connection piece	M10x1 to EN 1434				
	Material	Brass				
	Dimensions	(G)	G 3/8"	G 1/2"	G 3/4"	G 1"
	Width (AF)	(S)	20 mm	30 mm	32 mm	41 mm
		(L)	19 mm	16.5 mm	20 mm	20 mm
(L1)		11 mm	11.5 mm	14 mm	14 mm	
	(B)	Ø 5.7 mm (5.4 mm)				

Part	Description	Quantity and packaging	Art. No.
T-piece adapter G 3/8" / M10x1	Adapter for 3/8" T-piece for sensor mounting, M10x1	Loose without seal ring or locking top	19406
T-piece adapter G 1/2" / M10x1	Adapter for 1/2" T-piece for sensor mounting, M10x1	Loose, bag-packed with copper seal ring, without locking top	80072
T-piece adapter G 3/4" / M10x1	Adapter for 3/4" T-piece for sensor mounting, M10x1	Loose, bag-packed with copper seal ring, without locking top	80073
T-piece adapter G 1" / M10x1	Adapter for 1" T-piece for sensor mounting, M10x1	Loose, bag-packed with copper seal ring, without locking top	80074

Locking top M10x1

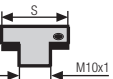
	Connection piece	M10x1 to EN 1434
	Material	Brass
	Width (S)	12 mm

Part	Description	Quantity and packaging	Art. No.
Locking top set M10x1	Locking top for T-piece adapter (G3/8" ... 1")	Bag-packed	80207

Sensor pockets mounting

Sensor pockets with CEN holder (M10x1) and straight protective tube

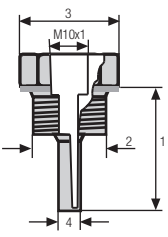
	Face-to-face length (1)	40 mm and 60 mm
	Process connection (2)	External thread G 1/2"
	Width (AF) (3)	24 mm
	Material	Brass
	Maximum media temperature	130 °C
	Pressure rating	PN 16
	External diameter (4)	6.6 mm
	Internal diameter of protective tube	5 mm
	Sensor mounting	with synthetic threads

Part	Description	Quantity and packaging	Art. No.
SP-M 40, single	Brass sensor pocket immersion depth 40 mm, G 1/2"	Single, bag-packed, with copper seal ring complying unit and installation instructions	80209
SP-M 40, set	Brass sensor pocket immersion depth 40 mm, G 1/2"	Paired, bag-packed, with copper seal ring complying unit and installation instructions	80075
SP-M 60, single	Brass sensor pocket immersion depth 60 mm, G 1/2"	Single, bag-packed, with copper seal ring complying unit and installation instructions	80210
SP-M 60, set	Brass sensor pocket immersion depth 60 mm, G 1/2"	Paired, bag-packed, with copper seal ring complying unit and installation instructions	80076

Accessories for sensor pocket / direct mounting of DS/PSC sensors with CEN holders (M10x1)

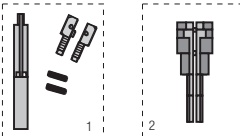
	Process connection	M10x1
	Mounting set for DS/PSC sensor (1)	Direct sensor mounting or in sensor pocket SP-M 40
	Coupling parts for SP-M 60 (2)	Mounting in sensor pocket SP-M 60 only

Part	Description	Quantity and packaging	Art. No.
Mounting set for DS/PSC sensors	Mounting components for direct mounting or in sensor pocket SP-M 40	1 pair of threaded coupling units (brown), 2 O-rings (4.3 x 2.4), tools and installation instructions	80205
Coupling for SP-M 60 (grey)	Mounting components for direct mounting or in sensor pocket SP-M 60	One threaded coupling unit (grey), folding	20040

Special versions: sensor pockets

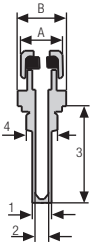
	Face-to-face length (3)	33 mm
	Process connection (4)	External thread G 3/8"
	Width (AF)	A = 17 mm, B = 14 mm and C = 22 mm
	Material	Brass
	Maximum media temperature	130 °C
	Pressure rating	PN 16
	External diameter (1)	6.6 mm
	Internal diameter of protective tube (2)	5 mm
	Sensor mounting	with cap nut

Part	Description	Quantity and packaging	Art. No.
ATH-33	Brass sensor pocket, immersion depth 33 mm, G 3/8"	Single, loose	81568

Direct mounting: for AMTRON® E-30 and ULTRASONIC E only

	Process connection (1)	M10x1
	Width (AF)	(2) = 12 mm, (3) = 24 mm
	Material	Brass
	Maximum media temperature	130 °C
	Pressure rating	PN 16
	Sensor mounting	with O-ring

Part	Description	Quantity and packaging	Art. No.
MG Mounting set for ball valve AMTRON® E-30/ULTRASONIC E CEN	Mounting set, brass	Single, bag-packed with installation instructions	81598
MG 1/2" Mounting set for T-piece AMTRON® E-30/ULTRASONIC E CEN with T-piece adapter 1/2"	Mounting set, brass,	Single, bag-packed with installation instructions	81599

PLC temperature sensors



Description

- Cable temperature sensor for pocket mounting (Pocket Long Cable), types Pt 100 and Pt 500, sensor diameter 6 mm, sensor lengths 105 mm, 140 mm, 175 mm and 230 mm
- Special versions for high absolute temperatures up to 180 °C
- Universally applicable for metering heat or cold (Type approvals according to 2004/22/EC (MID) and PTB K7.2 (cooling))

Applications

- For facilities with pipe diameters from approx. DN 50 upwards
- Good thermal properties with low heat radiation
- Two-wire connection but can be converted to four-wire using a sealed VD-30 distributor box
- Mounting with SP-E sensor pockets (see accessories for PLC and PLH temperature sensors)

Technical data

	Sensor type	Two-wire connection, Pt 100 and Pt 500
	Protective tube	Stainless steel
	Temperature range	0 to 150 °C (180 °C)
	Connector	Silicon
	Matched pairs (standard 150 °C)	at 10 °C, 65 °C, 120 °C
	Matched pairs (for 180 °C)	at 10 °C, 80 °C, 150 °C
	Tolerance class to 751	Class B
	Diameter of protective tube (1)	6 mm
	Material of protective tube	1.4571
	Length of sensor (2)	105, 140, 175 and 230 mm
	Connection wire terminals	Terminal sleeves to DIN 46 228 Part 4
	Connection wire lengths (4)	1500 mm and 2500 mm
	Size of tag to sensor end (3)	15 mm
	Type approval	according to 2004/22/EC (MID) and PTB K7.2 (cooling)
Permissible range for ΔT	3... 150 K (180 K)	

PLC - Pt 500 sensor

Part	Description	Quantity and packaging	Art. No.
PLC 500/105/2.5 m CE M/D cold	Pair of cable sensors Pt 500, sensor length 105 mm, connecting cable 2.5 m	Paired, bag-packed	80581
PLC 500/140/2.5 m CE M/D cold	Pair of cable sensors Pt 500, sensor length 140 mm, connecting cable 2.5 m	Paired, bag-packed	80582
PLC 500/175/2.5 m CE M/D cold	Pair of cable sensors Pt 500, sensor length 175 mm, connecting cable 2.5 m	Paired, bag-packed	80583
PLC 500/230/2.5 m CE M/D cold	Pair of cable sensors Pt 500, sensor length 230 mm, connecting cable 2.5 m	Paired, bag-packed	80584

PLC - Pt 100 sensor

Part	Description	Quantity and Packaging	Art. No.
PLC 100/105/2.5 m CE M/D cold	Pair of cable sensors Pt 100, Longueur de sonde 105 mm, connecting cable 2.5 m	Paired, bag-packed	80585
PLC 100/140/2.5 m CE M/D cold	Pair of cable sensors Pt 100, sensor length 140 mm, connecting cable 2.5 m	Paired, bag-packed	80548
PLC 100/175/2.5 m CE M/D cold	Pair of cable sensors Pt 100, sensor length 175 mm, connecting cable 2.5 m	Paired, bag-packed	80549
PLC 100/230/2.5 m CE M/D cold	Pair of cable sensors Pt 100, sensor length 230 mm, connecting cable 2.5 m	Paired, bag-packed	80586

For special applications

PLC 180 °C	Order for special applications		180413
------------	--------------------------------	--	--------

PLH temperature sensors

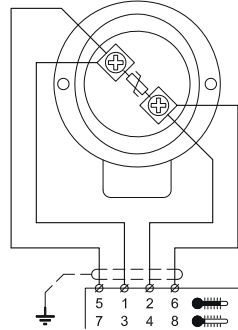

Description

- Head sensor for pocket mounting (Pocket Long Head), types Pt 100, sensor diameter 6 mm, sensor lengths 105 mm, 140 mm, 175 mm and 230 mm
- Special versions for low temperature differences (e.g. for cooling measurements) and high absolute temperatures up to 180 °C
- Maximum connection cable length to CALEC® ST and AMTRON® X-50: 15 m.
Maximum connection cable length to CALEC® energy master: 100 m

Applications

- For facilities with pipe diameters from approx. DN 50 upwards
- Good thermal properties with low heat loss
- Two-wire connection but can be converted to four-wire by connecting directly to the sensor head
- Mounting with SP-E sensor pockets (see. accessories for PLC and PLH temperature sensors)
- Ohmic resistance of connection cable to computer has no influence on temperature measurement

Technical data

	Sensor type	Two-wire connection Pt 100 and Pt 500
	Protective tube	Stainless steel
	Temperature range	0 to 150 °C (180 °C)
	Connector	Metal, version PL
	Matched pairs (standard 150 °C)	at 10 °C, 65 °C, 120 °C
	Matched pairs (for cooling applicat.)	at (0 °C), 10 °C, 30 °C, 50 °C
	Matched pairs (180 °C)	at 10 °C, 80 °C, 180 °C
	Tolerance class to IEC 751	Class B
	Diameter of protective tube (1)	6 mm
	Material of protective tube	1.4571
	Length of sensor (2)	105, 140, 175 and 230 mm
	Height of sensor head (3)	44.5 mm
	Connection head (4)	33 mm
	Type approval	EN 1434 for Switzerland and Germany, 2004/22/EC (MID)
Permissible range for ΔT	3...150 K	
Verification	On demand for Switzerland and Germany	

PLH - Pt 100 sensor

Part	Description	Quantity and packaging	Art. No.
PLH 100/105 CE M	Pair of head sensors Pt 100, sensor length 105 mm	Paired, bag-packed	80360
PLH 100/140 CE M	Pair of head sensors Pt 100, sensor length 140 mm	Paired, bag-packed	80361
PLH 100/175 CE M	Pair of head sensors Pt 100, sensor length 175 mm	Paired, bag-packed	80362
PLH 100/230 CE M	Pair of head sensors Pt 100, sensor length 230 mm	Paired, bag-packed	80363

Cold applications (special testing points in the temperature range from 0 to 50 °C, no approval in accordance with PTB K7.2)

Part	Description	Quantity and packaging	Art. No.
PLH 100/140 verified / cold	Pair of head sensors Pt 100, sensor length 140 mm for cold applications	Paired, bag-packed	80085
PLH 100/175 verified / cold	Pair of head sensors Pt 100, sensor length 175 mm for cold applications	Paired, bag-packed	80086

For special applications

PLH 180 °C	Order for special application		180412
------------	-------------------------------	--	--------

Accessories for PLC and PLH temperature sensors

Description

- Stainless steel sensor pockets, face-to-face lengths 85 mm, 120 mm, 155 mm and 210 mm for PN 40
- Reinforced 210 mm sensor pocket for flows greater than 2 m/s
- Steel or stainless steel welded sleeve
- Distributor box VD-30 converting from two- to four-wire connections
- Extension cable for distributor box

Note

The face-to-face sensor pocket length for PLC and PLH sensors must be 20 mm shorter than the length of the sensor itself. This is shown in the table below

SP-E (SP-EV) sensor pocket

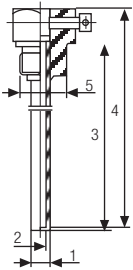
	External diameter (1)	8 mm
	Internal diameter of protective tube (2)	6 mm
	Material of protective tube	1.4571
	With sealing screw	
	Maximum media temperature	200 °C
	Pressure rating	PN 40
	Thread (5)	G 1/2"
	Length (4)	98, 133, 168 and 223 mm
	Face-to-face length (3)	85, 120, 155 and 210 mm

Product range

Part	Description	Quantity and packaging	Art. No.
SP-E 85 / 105	Stainless steel sensor pocket G1/2", face-to-face length 85 mm, PN 40, for sensor PLxxx/105	Single, with copper seal ring, bag-packed	80059
SP-E 120 / 140	Stainless steel sensor pocket G1/2", face-to-face length 120 mm, PN 40, for sensor PLxxx/140	Single, with copper seal ring, bag-packed	80060
SP-E 155 / 175	Stainless steel sensor pocket G1/2", face-to-face length 155 mm, PN 40, for sensor PLxxx/175	Single, with copper seal ring, bag-packed	80062
SP-E 210 / 230	Stainless steel sensor pocket G1/2", face-to-face length 210 mm, PN 40, for sensor PLxxx/230	Single, with copper seal ring, bag-packed	80064
SP-EV 210 / 230	Stainless steel sensor pocket G1/2", reinforced for $v > 2$ m/s, face-to-face length 210 mm, PN 40, for sensor PLxxx/230	Single, with copper seal ring, bag-packed	80077

Welded sleeve

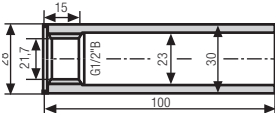
	External diameter	30 mm
	Pressure rating	PN 40
	Thread	Internal thread G 1/2"
	Length	100 mm
	Material of protective tube	Steel / stainless steel

Part	Description	Quantity and packaging	Art. No.
SWM-11	Steel welded sleeve for the face-to-face length of the sensor pocket	Single, with copper seal ring, bag-packed	81551
SWM-12	Stainless steel welded sleeve for the face-to-face length of the sensor pocket	Single, with copper seal ring, bag-packed	81552

Connection box (VD-30), extension cable (10x0.5 mm)

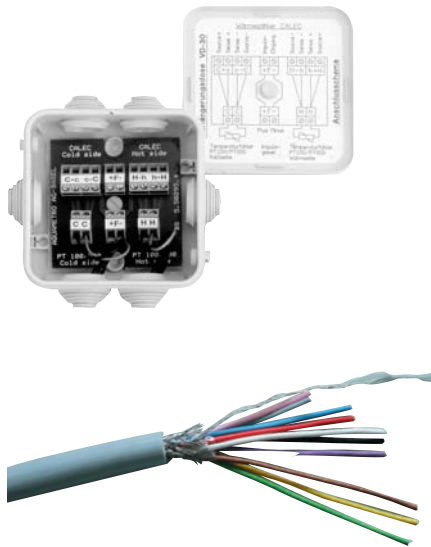

Description

Temperatur sensor cables can be extended by 4 wires by means of the connexion box VD-30, avoiding the measurement errors other wise created by additional resistance of a 2 wire extension.

Please comply with relevant national approval regulations on usability.

Features of VD-30:

- Converts 2-wire cable sensors systems (measurement of resistance) to 4-wire systems (measurement of voltage loss)
- Negligible cable resistance for smaller cable diameters
- Appropriate extension of cable sensors (PLC and DS/PSC)
- Optional connection for a passive pulse transmitter
- Clear installation
- Optional access protection with lead seal

Extension cable recommended

- 10-core, flexible, 0.5 mm²
- Screened
- Cable designation LiYCY

Part	Description	Quantity and packaging	Art. No.
VD-30	Distributor box for temperature sensor and pulse transmitter	Single, bag-packed with installation instructions	93331
Cable 10x0.5 mm screened	Cable for cable sensor and pulse transmitter extension with VD-30	per meter	20042

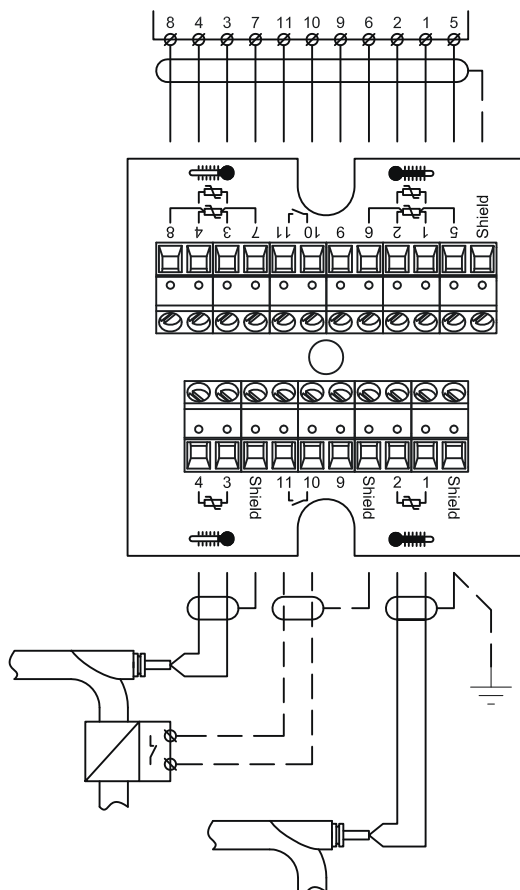

Mounting sets

Complete mounting set

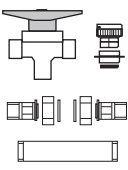
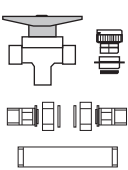
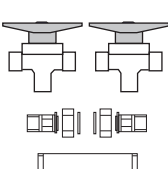
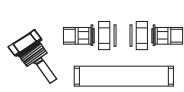
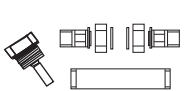
1/2" for AMTRON® E-30/ULTRASONIC E CEN	Complete mounting set for AMTRON® E-30/ULTRASONIC E CEN	81632
	consisting of	1 x KGH 1/2" 1 set VSR 3/4" - 1/2" 1 x PSG DN 15 x 110 mm 1 x Mounting set temperature sensor AMTRON® E-30
3/4" for AMTRON® E-30/ULTRASONIC E CEN	Complete mounting set for AMTRON® E / ULTRASONIC E CEN	81597
	consisting of	1 x KGH 3/4" 1 set VSR 1" - 3/4" 1 x PSG DN 20 x 130 mm 1 x 1 x Mounting set temperature sensor AMTRON® E-30
For compact heat meters	Complete mounting set for compact heat meters	81586
	consisting of	1 x KGH 1/2" 1 set VSR 3/4" - 1/2" 1 x PSG DN 15 x 110 mm
For compact heat meters	Complete mounting set for compact heat meters	81655
	consisting of	1 set VSR 1" - 3/4" 1 x PSG DN 20 x 130 mm 1 x SP-M 40
	Complete mounting set for compact heat meters	81654
	consisting of	1 set VSR 3/4" - 1/2" 1 x PSG DN 15 x 110 mm 1 x SP-M 40

Recommendations for installation

Mechanical considerations

The location of the installation point of the temperature sensors and the flow sensor in the heating/cooling circuit is determined by the measurement itself. The two temperature measurement points form the limits for which the energy flow is calculated. (The supplier, for example, bears all pipe losses, which occur upstream, and the consumer all those downstream from the temperature measurement points.)

Both sensors for differential temperature measurement must be installed in an identical way. This also applies to the pipe diameter and the thermal insulation of the sensor surroundings. The aim is to ensure the same flow rates and thermal conditions for both measurement points. If, for example, one of the sensors is installed in non-insulated pipe, then the second should/must also be installed in non-insulated pipe (principle of equality).

The sensors should be preferably installed so that the first 10 mm of the one upstream (active measuring length) is in the middle third of the pipe cross-section.

Adjusting the face-to-face length is done with welded sleeves. These also ensure that the sensor locking screw is still accessible after attaching the insulation. Welded sleeves are made to a standard length of 100 mm. They must be adjusted to the pipe in both length and position.

Sensor pockets and head sensors must be installed so that there is sufficient room to replace them. (The sensors or measuring inserts must be in a position to be removed easily without the use of force).

The type of sensors used must be suitable for the temperature, pressure and flow speed of the application. Sensors, especially those with long immersion lengths, may be subject to considerable forces created by the flow.

The standard sensors today ensure maximum heat transfer with the sensor fitting snugly in the sensor pocket. Any dirt in the immersion tube will prevent the sensor from being properly seated in the pocket, and thus falsifying the results. The pockets are therefore mounted either from the side or from below. This is especially important for cooling systems as otherwise condensation or ice can build up in the pocket.

Immersion lengths for Aquametro for sensor pockets and temperature sensors

Recommendations for heating systems

Insulation in the heating loops, heating plant regulations (Example: Germany)

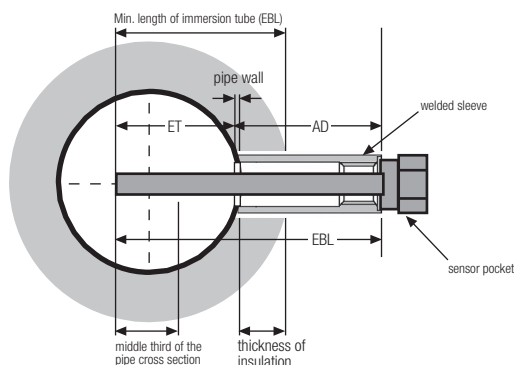

Pipe cross-section (mm)	Thickness of insulation (ID)
up to DN 20	20 mm
DN 20 to DN 35	30 mm
DN 40 to DN 100	same ID as width
DN 100 upwards	100 mm

Nominal width of pipe DN	15	20	25	32	40	50	65	80	100	125	150	200	250	300
Thickness of insulation (mm)	20	20	30	30	40	50	65	80	100	100	100	100	100	100
Immersion depth ET (mm)	10	15	20	25	30	38	45	60	70	83	95	120	145	170
Face-to-face length EBL (mm)	30	35	50	55	70	88	110	140	170	183	195	220	245	270
External length for sensor pockets in relation to immersion depth														
3/8" / ATH-33	23	18	13	8										
1/2" / SP-M 40	30	25	20	15	10									
1/2" / SP-M 60		45	40	35	30	22	15							
1/2" / SP-E 85/105				60	55	47	40	25	15					
1/2" / SP-E 120/140					90	82	75	60	50	37	25			
1/2" / SP-E 155/175						117	110	95	85	72	60	35	10	
1/2" / SP-E 210/230							165	150	140	127	115	90	65	40

Recommendations for cooling systems

Remarks

- Larger insulation thickness
- Condensate run-out: mounting from below

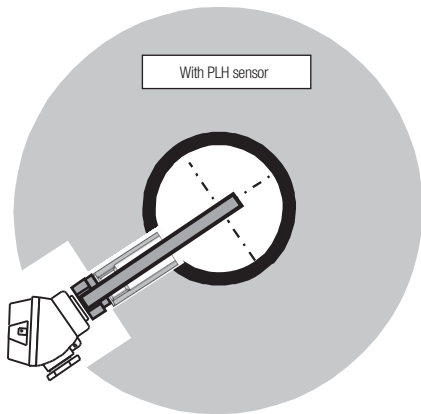
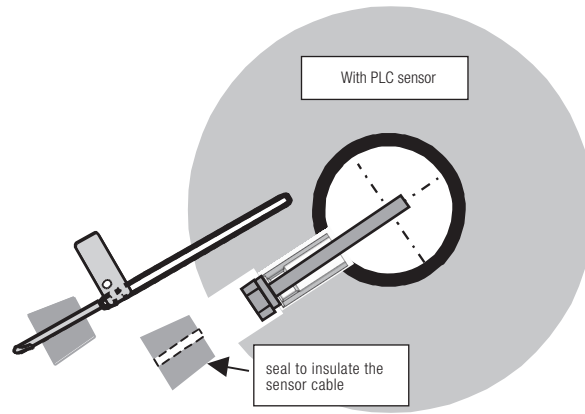

DISTRIBUTOR:

HEAD OFFICE:

AQUAMETRO AG
Ringstrasse 75
CH-4106 Therwil

Phone +41 61 725 11 22
Fax +41 61 725 15 95
info@aquametro.com

AQUAMETRO (S.E.A.) Pte Ltd
No. 21 Bukit Batok Crescent #11-84
The WCEGA Tower
Singapore 658065
Phone +65 6899 1980
Fax +65 6899 2972
jimmycheong@aquametro.com.sg



www.aquametro.com