



# Magnetic Flowmeter **FLOMAG**<sup>®</sup> 3000



**FLOMAG s.r.o.**  
Šumavská 5  
CZ-602 00 Brno  
Czech Republic  
tel: +420 541212539  
fax: +420 549240356  
e-mail: [info@flomag.com](mailto:info@flomag.com)  
[www.flomag.com](http://www.flomag.com)

**Installation and Operation**



## Principle of measurement

An magnetic flowmeter is used for volume flow measurement of electrically conductive liquids. Measurement principle is based on Faraday law on electromagnetic induction. A sensor consists of a non-magnetic tube with non-conductive lining, measuring electrodes and two coils generating electromagnetic field. Flowing liquid forms a conductor. Magnetic field induces voltage  $U$  in this conductor that is proportional to magnetic induction  $B$ , distance between electrodes  $d$  and flow velocity  $v$ .

$$U = B \times d \times v$$

As magnetic induction and distance between electrodes are constant, induced voltage is proportional to velocity of liquid flow in the tube. Volume flow rate is product of flow velocity and tube cross section.

$$Q = v \times S$$

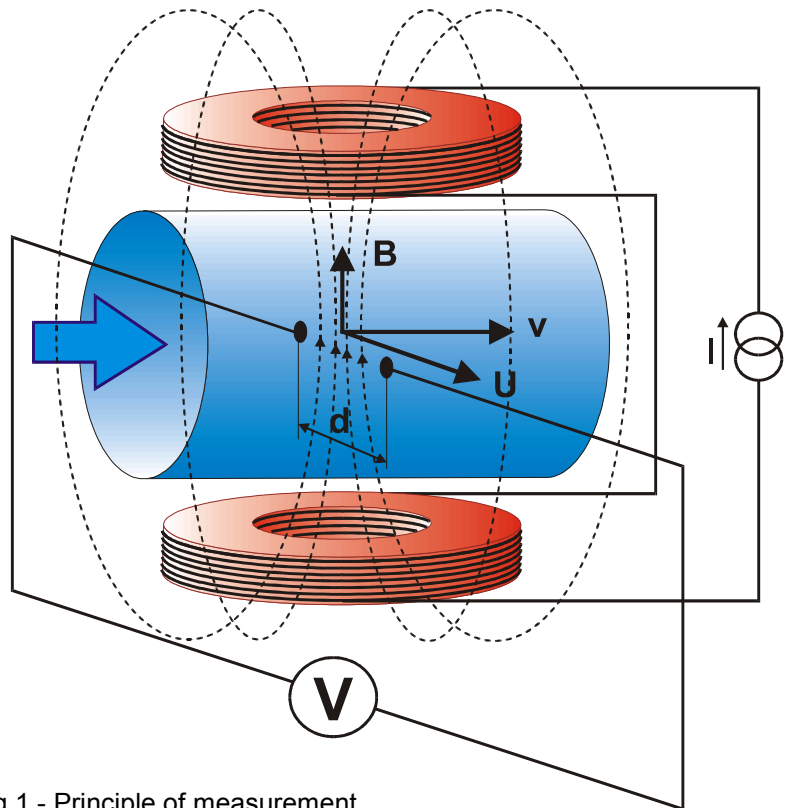

Fig.1 - Principle of measurement

## Technical solution

The magnetic flowmeter itself consists of two basic parts – a flow sensor and a converter. The converter can be either an integral part of the sensor (compact version) or separated, connected with the sensor using a cable (remote version).

The sensor consists of a non-magnetic tube with non-conductive lining, measuring electrodes, excitation coils and cables. There are various sensor versions available enabling connection to adjacent tubes with flanges (type **P**) and fittings (gas fitting type **G** or food industry fitting type **V**) or wafer which are installed between flanges using clamps (type **B**). Non-conductive lining can be made of technical rubber (types **TG**, **MG** or **NG**) or Teflon (type **T**).

The converter is used for generating excitation current in coils, processing of signal from measuring electrodes, displaying of measured data and generating output signals. Current in excitation coils has constant value 250 mA or 125 mA and is pulse

generated with alternating polarity to avoid permanent magnetization of the sensor. Excitation pulse frequency can be chosen from six values – 25 Hz, 12,5 Hz, 8,33 Hz, 6,25 Hz, 3,125 Hz and 1,56 Hz. Excitation current of 250 mA with excitation frequency 3,125 Hz is suitable for all standard applications. Other settings can be used for specific applications. Excitation current and frequency are factory set before sensor calibration and their later modifications are not allowed.

Voltage induced in measuring electrodes is measured always on the end of excitation pulse when magnetic field is steady. Each excitation pulse is followed by refreshing period. Signal processing and parameter setting are performed digitally and the converter contains no setting controls or other moving parts what ensures its high reliability and long-term stability.

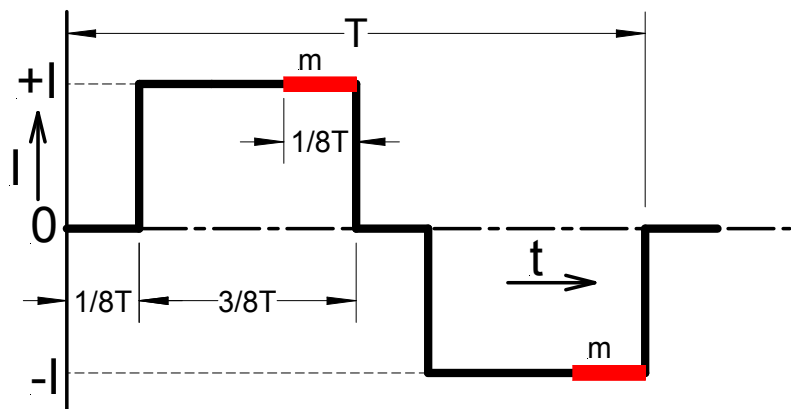

Fig. 2 - Excitation pulse form

# Installation instructions

The flowmeter will give the best results when flow of liquid is steady. Therefore a few basic recommendations should be observed for its locating in a pipeline. There should be no transitions between the sensor and the adjacent pipeline that could be a source of turbulence. Correct axial alignment should be observed during installation. A gasket should not exceed internal edges of tubes.

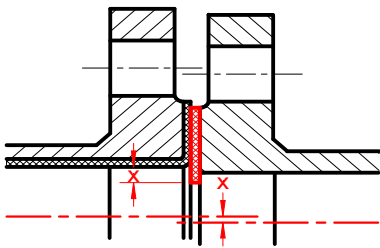

Fig. 3 - Overlaps

Minimum straight steady lengths of pipeline are required on both sides of the flow sensor. Their lengths have to be proportional to pipeline internal diameter.

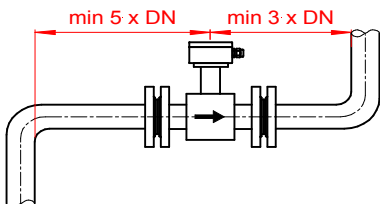

Fig. 4 - Steady lengths

If more interfering elements are present near the sensor (e.g. bends, fittings), required steady length should be multiplied by number of these interfering elements. Reductions with slopes up to 8° can be included in steady lengths.

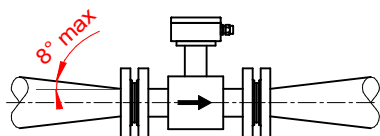

Fig. 5 - Reduction

If water in the pipeline is pumped by a water pump, the sensor should be always located behind the pump to avoid low pressure that can damage the sensor. Steady length of at

least 25DN is required between the pump and the sensor.

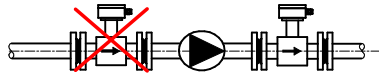

Fig. 6 - A water pump

For the same reason, never locate stop valves behind the sensor.

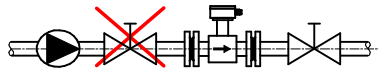

Fig. 7 - Stop valves

The sensor can work both in horizontal and vertical positions; only axis of measuring electrodes inside the sensor must always remain in horizontal position and tapping of the sensor should be directed upwards at horizontal installations.

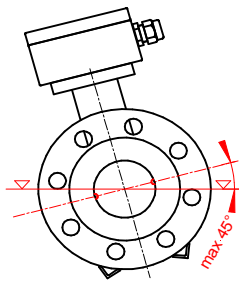

Fig. 8 - Electrode axis

For vertical installations, liquid should flow upwards.

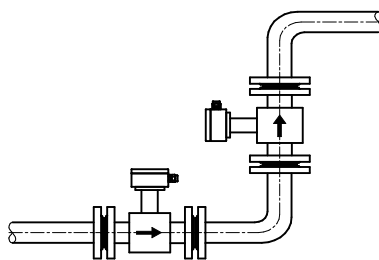

Fig. 9 - Vertical installation

To ensure correct measurement and to avoid air lock, whole sensor cross section should be flooded. Therefore never locate the sensor in upper parts of the pipeline or in vertical positions with liquid flowing downwards.

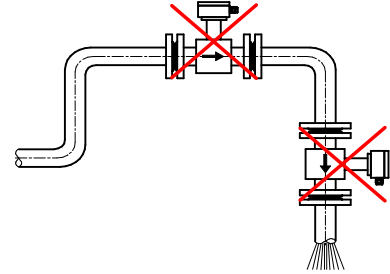

Fig. 10 - Danger of air lock

If permanent flooding of whole pipeline cross section cannot be ensured, it is possible to locate the sensor in a low water trap so that it can be always completely flooded. Free water discharge should be located 2DN higher than the sensor.

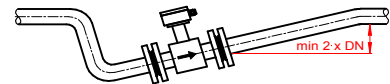

Fig. 11 - Permanent flooding

To avoid vibrations that could damage the sensor, ensure that the adjacent pipeline is always supported as near to the sensor as possible.

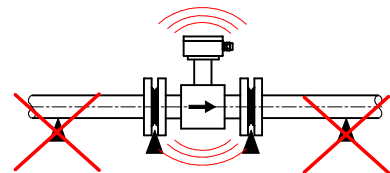

Fig. 12 - Danger of vibrations

Where continuous flow of fluid is required and removal of the sensor is impossible, a bypass should be installed. The same applies for locations where sensor removal would require draining of too long part of the pipeline.

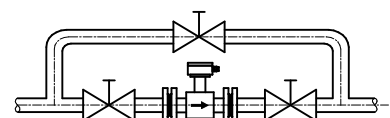

Fig. 13 - A bypass

## Sensor grounding

Correct function of the magnetic flowmeter requires perfect electrical connection between the sensor and the adjacent pipeline, grounding potential and the power supply protective wire. For the flanged sensor with the adjacent conducting pipeline, flanges should be electrically connected and the pipeline grounded.

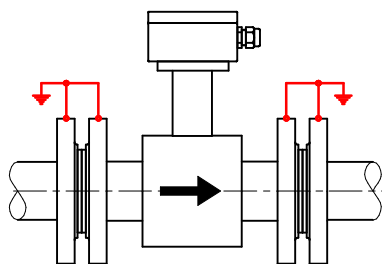

Fig.15: Grounding of flanges

If the adjacent pipeline is non-conductive, grounding rings should be inserted in it or equivalent method should be

used to connect measured fluid electrical potential with ground.

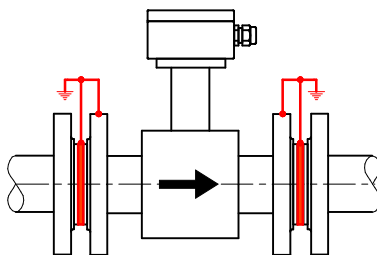

Fig.16: Grounding rings

For the wafer sensor, grounding can be provided by electrical

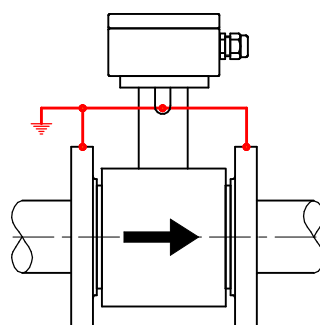

Fig.17. The wafer sensor

connection of sensor clamping flanges with grounding point of the sensor.

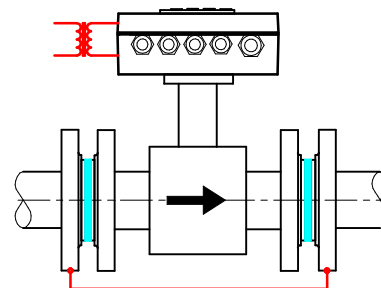

Fig.18: Cathodic protection

If electric current flows through the pipeline, e.g. for pipeline cathodic protection against corrosion, the sensor should be electrically isolated from the adjacent pipeline. The sensor should be bridged over using a wire and galvanic isolation of the flowmeter power supply should be provided so that the flowmeter can be isolated from all other devices.

## Selection of suitable sensor lining and electrode material

### Linings

Sensors have a non-conductive lining from various materials. Choice of material depends on measured fluid characteristics.

#### • **Technical rubber**

Technical rubber is suitable for low aggressive fluids with operational temperatures from 0.1 °C to 70 °C. It fits for most water management and sewage treatment applications. It is manufactured in two variants "TG" – with hard structure and "MG" – with soft structure. Soft structure is used for fluids with higher content of abrasive particles (e.g. sand). It is not suitable for drinking water.

#### • **Resistant rubber**

Type "NG" is suitable for medium aggressive fluids with operational temperatures from 0.1 °C to 90 °C. It can be used for measurement of hot service water, condensate etc., as well as for drinking water. If tem-

perature 100 °C can be exceeded, Teflon (PTFE) lining is recommended.

#### • **Teflon or Hallar**

Type "T" is the most universal lining for aggressive fluids with operational temperatures from -20 °C to 150 °C. It is suitable for chemical and food industry applications.

### Electrodes

Choice of material of measuring electrodes also depends on measured fluid characteristics.

#### • **Stainless steel – "Ss"**

Standard electrodes are made of stainless steel AISI 316Ti. They are suitable for all usual water based fluids and for lower concentrations of acids and caustics.

#### • **Hastelloy C-22 – "Ha"**

For some special applications, material of higher quality should be used. Hastelloy C-276 elec-

trodes are characterized by increased resistance against acids and caustics and usually are suitable for most of industrial applications.

#### • **Titanium – "Ti"**

Suitable for some acids, lyes, chlorine, urea and sewage.

#### • **Platinum – "Pt"**

For particularly aggressive fluids like concentrated acids and caustics, chemically extremely resistant material should be chosen – platinum. However, high cost of this material is its essential drawback.

\* **Note** – We can recommend suitable lining and electrode materials for your particular application.

## Correct sensor size selection

Converter is capable to detect flow rates as low as 0.1 m/s. Upper limit is determined by capability of liquid to maintain continuous flow at higher velocities. This is usually true for flow rates up to 12 m/s.

Measurement error rapidly increases for too low flow rates, as can be seen in the diagram. It shows limits of maximum relative measurement error as function of liquid flow rate.

On the other side, too high flow rate causes discontinuity of flow and results in chaotic turbulence and vacuum traps. This results in instable measurement and too high drift of flow rate values.

Ideal operational range of the sensor is in range from 0.5 to 5 m/s. This range is highlighted in the diagram for correct size selection.

Flow rate ranges for individual sizes are chosen to meet EN

DN	Range marking							
	S10	A25	B25	C25	C50	D25	D50	D100
	Range Q3/Q1							
	R10	R25	R25	R25	R50	R25	R50	R100
10	1	0.63	<b>1</b>	1.6	1.6	2.5	2.5	2.5
15	2.5	1.6	<b>2.5</b>	4	4	6.3	6.3	6.3
20	4	2.5	<b>4</b>	6.3	6.3	10	10	10
25	6.3	4	<b>6.3</b>	10	10	16	16	16
32	10	6.3	<b>10</b>	16	16	25	25	25
40	16	10	<b>16</b>	25	25	40	40	40
50	25	16	<b>25</b>	40	40	63	63	63
65	40	25	<b>40</b>	63	63	100	100	100
80	63	40	<b>63</b>	100	100	160	160	160
100	100	63	<b>100</b>	160	160	250	250	250
125	160	100	<b>160</b>	250	250	400	400	400
150	250	160	<b>250</b>	400	400	630	630	630
200	400	250	<b>400</b>	630	630	1000	1000	1000
250	630	400	<b>630</b>	1000	1000	1600	1600	1600
300	1000	630	<b>1000</b>	1600	1600	2500	2500	2500
350	1000	630	<b>1000</b>	1600	1600	2500	2500	2500
400	1600	1000	<b>1600</b>	2500	2500	4000	4000	4000
450	1600	1000	<b>1600</b>	2500	2500	4000	4000	4000
500	2500	1600	<b>2500</b>	4000	4000	6300	6300	6300
600		2500	<b>4000</b>	6300	6300	10000	10000	10000
700		2500	<b>4000</b>	6300	6300	10000	10000	10000
800		4000	<b>6300</b>	10000	10000			
900		4000	<b>6300</b>	10000	10000			
1000		<b>6300</b>	10000					
1200		<b>6300</b>	10000					

Tab. Sensor ranges in m<sup>3</sup>/h according to their sizes

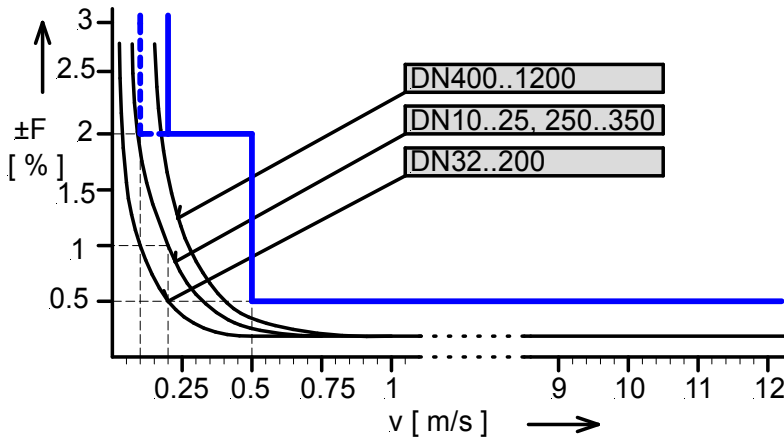

14154 standard and they are shown in table. Preferred ranges are highlighted in bold. For non-specified working meters, other range can be also specified on request.

If range is not specified in a purchase order, the sensor will be calibrated in preferred range in accordance with the table above.

Fig. Limit of maximum relative error of measurement

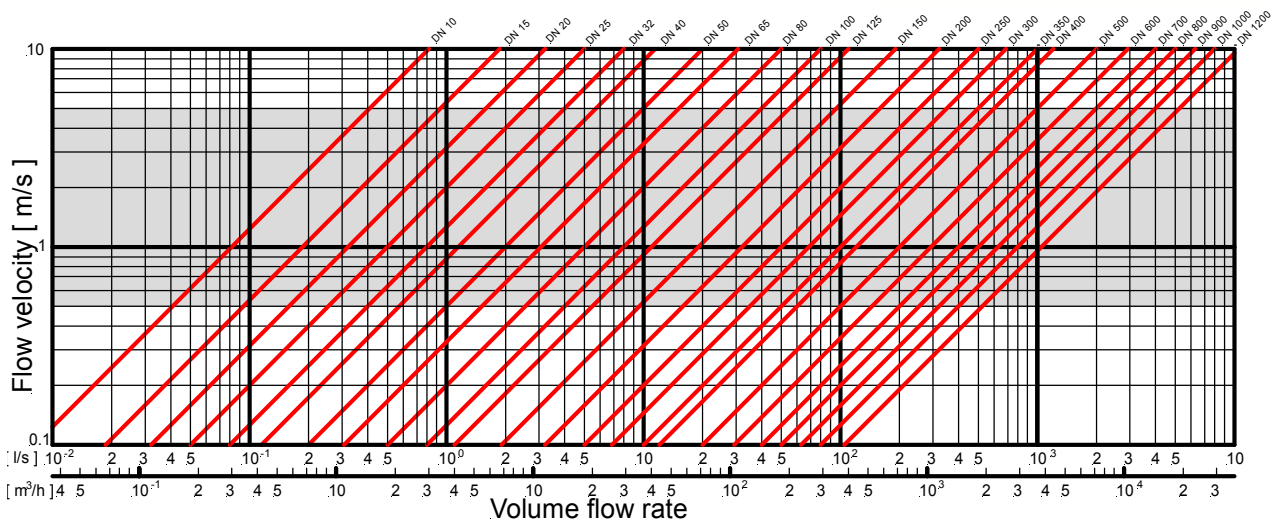

## Block diagram of the flowmeter

Main advantage of the magnetic flowmeter FLOMAG3000 is its significant variability. Flowmeter converter in basic version consists only of power supply, microcomputer and sensor input module (module 1). Display, outputs and other optional features are available as plug-in modules. Thus, customer pays only for features that he really uses. Plug-in modules contain memories where all configuration data is stored. In this way, optional features can be added or modified as required anytime during the service life of the flowmeter.

There are 4 free positions available (module 4, 5, 6 and 7) for binary and analog output modules. Their signals are usually processed by connected technological devices. All output modules have galvanic isolation. At the same time, up to 4 binary output modules can be fitted. These can operate either as pulse or frequency outputs for flow rate indication. Alternatively,

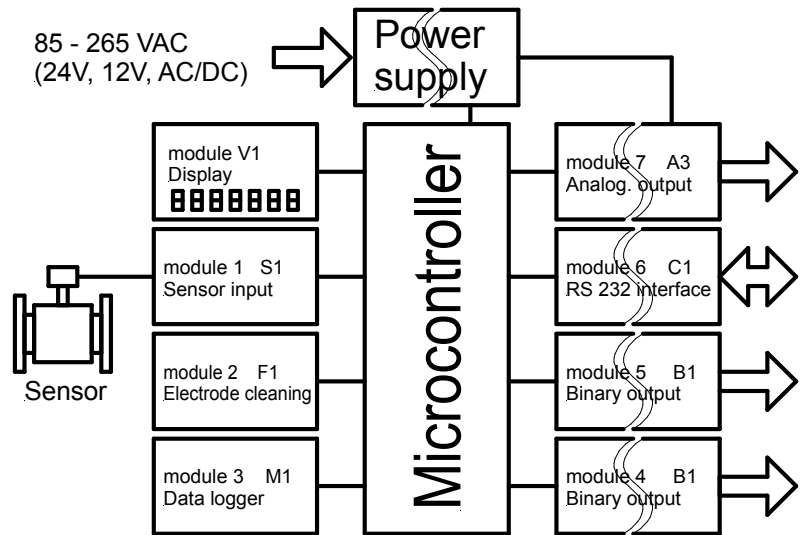

Fig. 19: Block diagram of the flowmeter

tively, they can serve for indication of flowmeter limit conditions. Galvanic isolation is ensured by an optoelement or a relay. One position (module 7) is dedicated for the active analog output module. Modules with various accuracy and ranges are available. One position (module 6) is designed for

the serial communication module. RS 232, RS 485 or M-Bus interface can be plugged in.

Position (module 2) is for the electrochemical electrodes cleaning module.

## Terminal connections

The converter is integrated in a rugged aluminium box. After opening the box you will gain access to terminals. Terminals 17, 18 and 19 are for power

supply. Terminals A, B, C, D and E are used for the sensor. For compact version, the sensor is connected internally and terminals remain free. Termi-

nals 1 to 16 are used for connection of inputs and outputs of optional modules (binary outputs, current output, RS232, RS485 etc.)

A	Module 1
B	Sensor connection
C	Connected
D	internally
E	for compact version
1	module 2 F2 - F3
2	
3	Not connected
4	
5	
6	module 4
7	A4, B1-B5, E1
8	module 5
9	A4, B1-B5, E1
10	module 6
11	A4, B1-B5, C1, D1, D2, E1
12	module 7
13	A1 - A5, B1-B5, E1
14	
15	Not connected
16	
17	L
18	N
19	PE

Tab. Converter terminals

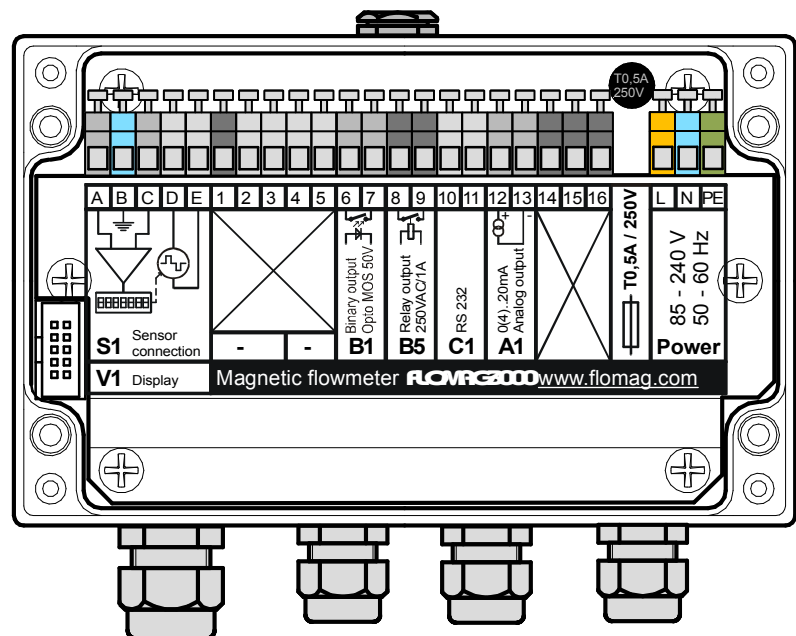

Fig. 20 Converter – location of terminals

For the remote sensor, there is a terminal box in its tapping (see figure 21). The sensor should be connected to the converter using a double shielded

cable. You can use our special sensor cable **PAAR-LiYCY-CY [1X(2X0,25 LiYCY)+1X(2X0,75 LiYCY)+1X0,75]CY** (length up to 200 m) or standard double

shielded cable **Lapp UNITRONIC Cy PiDY 2x2x0.25** or **Alpha 1243/2C** (length up to 50 m).

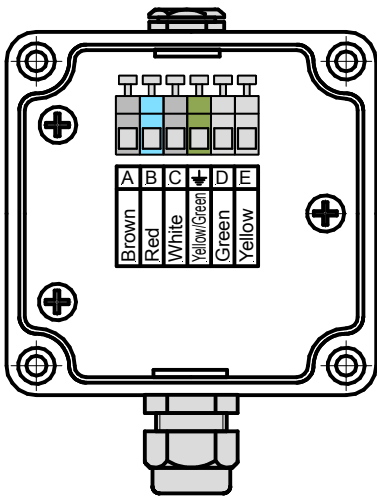

Fig. 21: Sensor terminal box

Maximum length of the cable between evaluation unit and the sensor is significantly limited by conductivity of measured fluid, as shown in Figure 23.

Remote version should be used when measured fluid is too hot to avoid heat transfer to converter. See Figure 24 for assessment of remote version utilization.

Parallel running of power and

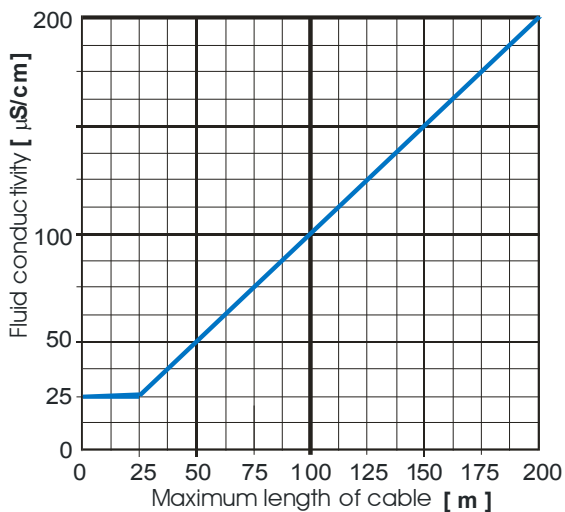

Fig. 23: Maximum length of the cable and conductivity

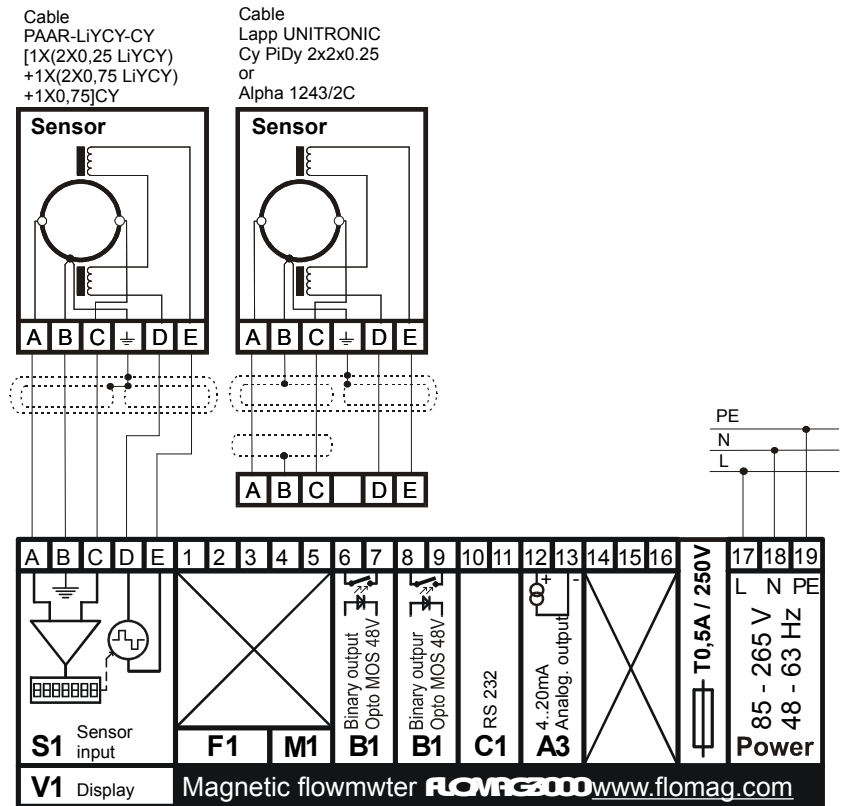

Fig. 22: Remote sensor connection

signal wires is highly inappropriate; especially in case of the cable that connects the sensor with the remote converter. If the instrument is used in environment with strong electromagnetic interference, cables should be rather as short as possible.

For connection of electronic converter input and output terminals, shielded cables are suit-

able.

For connection of mains voltage, a standard three-core cable, e.g. CYKY 3x1,5 (wire) or VM03VQ-F 3x1 (wire strand) is recommended. The instrument has no switch so it should be fused and switched using other device.

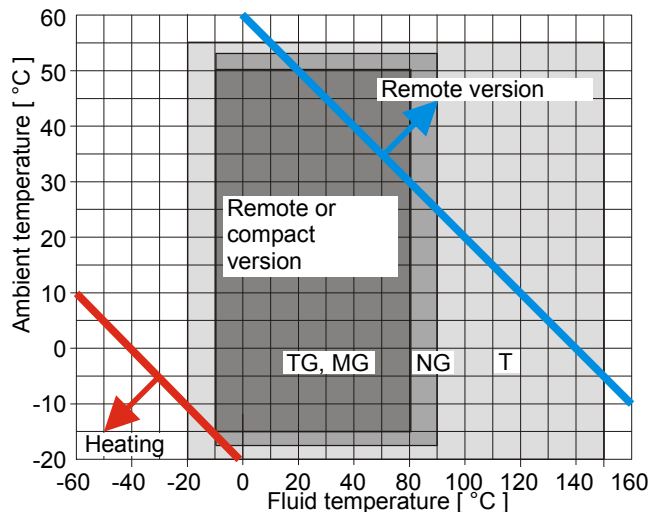



Fig. 24: Selection of version according to temperature



## Displayed data

The instrument is equipped with a high quality backlit two-line alphanumeric display with character height 9.6 mm (2x16 characters) providing good readability even from longer distances. Backlight function works in energy saving mode. Backlight time is limited to 254 seconds after last pressing of any key. If backlight is off, pressing of any key will switch it on again. Backlight time can be set in menu from 20 seconds to 254 seconds. Setting to 0 switches backlight permanently off; setting to 255 switches it permanently on.

Up to 8 basic readings can be read from the converter display. You can alternate them using  key. Additional information accessible via  key is available for some displayed data.

### Flow rate

- Flow rate value treated by floating averaging. Number of averaging steps can be changed in range from 1 to 256. Flow rate units can be changed as required.

Number of displayed *decimal places* can be set in range from 0 to 4.

### Total volume (+)

- Total volume of liquid flowed in direction of arrow on the sensor from start of measurement.

### Total volume (-)

- Total volume of liquid flowed in opposite direction of arrow on the sensor from start of measurement.

### Volume difference

- Difference between positive and negative volumes flowed from start of measurement.

### Operation time

- Total time of operation from initial switching instrument on in hours and minutes.

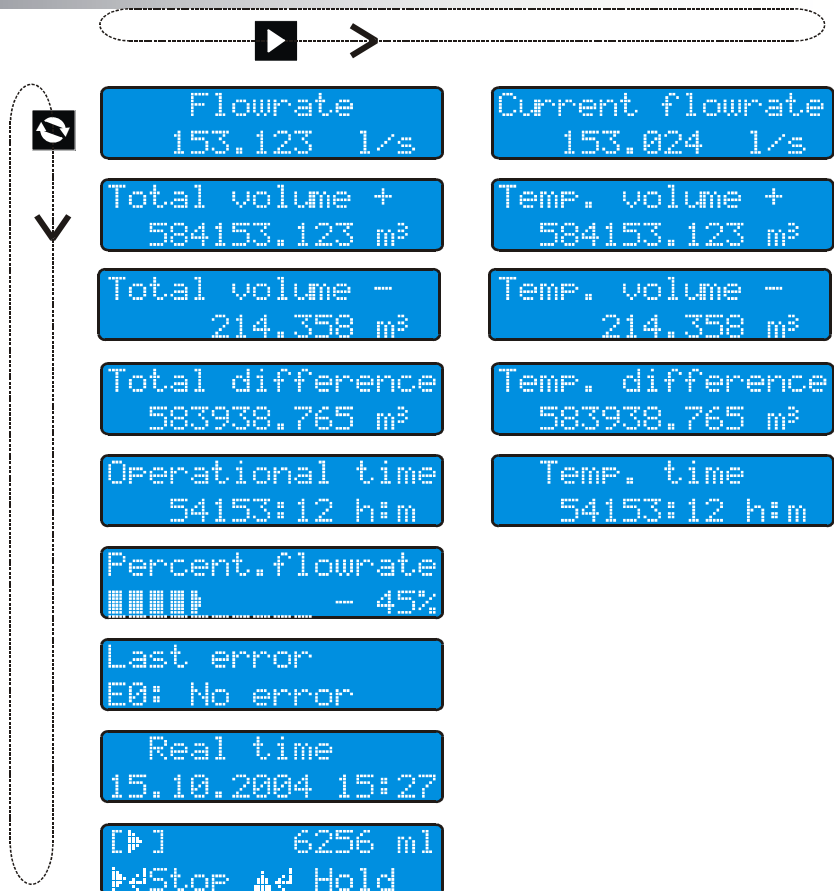

Fig. 25: Displayed data

### Percent. flow rate

- Flow rate information indicated by horizontal bar (its width corresponds to flow rate) and as numeric value in per cents of chosen maximum value.

### Last error

- Abbreviated text of the last error message.

### Current flow rate

- Flow rate value untreated by floating averaging.

### Temporary volume +

- User resettable value of volume flowed in direction of arrow on the sensor.

### Temporary volume -

- User resettable value of volume flowed in opposite direction of arrow on the sensor.



### Temporary difference

- User resettable value of difference between volumes flowed

in direction and in opposite direction of arrow on the sensor.

### Temporary time

- User resettable value of volume flowed in direction of arrow on the sensor.

Values of temporary counters can be reset by holding  key and simultaneous pressing  key. This will reset all counters at the same time – both volumes and time.

### Batching

- Shows information about the running batch. Detailed information is given in chapter Batching.

# Archiving

Electromagnetic flowmeter FLOMAG3000 automatically saves in fixed time intervals, the value of the flowed volume. There are three archives.



Fig. Hour archive

Hour archive where it is possible to find the flowed volumes about the last 192 hours (8 days).



Fig. Daily archive

Daily archive where it is possible to find the flowed volumes about the last 192 days (more than half year).



Fig. Month archive

Month archive where it is possible to find the flowed volumes

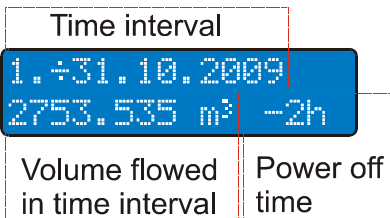

- Ok - without power off
- #s - power off time in seconds
- #m - power off time in minutes
- #h - power off time in hours
- #d - power off time in days

## Fig. Legend

about the last 12 months.

Upper line shows always time interval of the item in the archive. Second line shows the flowed volume in the fixed time interval and the power off time in the fixed time interval (the flowmeter was without power supply).

## Listing in archive

Pushing key , roll to item Total volume+. By repeated pushing of key you can find gradually Flow rate +, hour archive, day archive and month archive.

By repeated pushing of key , in the hour archive you can see gradually the saved sam-

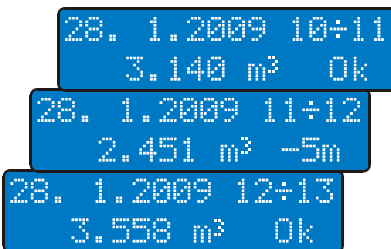

Fig. Hour archive moving

ples from the previous hour, totally 192 hours back.

By repeated pushing of key , in the daily archive you can see gradually the saved sam-

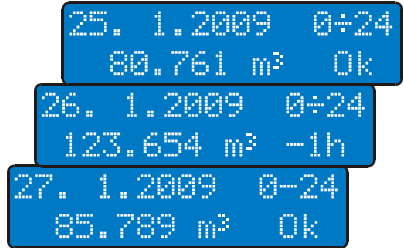

Fig. Daily archive moving ples from the previous day, totally 192 days back.

By repeated pushing of key , in the month archive you can see gradually the saved samples from the previous

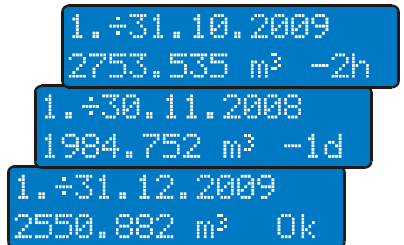

Fig. Month archive moving

month, totally 12 months back.

If you want to go back to the last saved sample, please push and hold key and together with it push key .

# Error messages

In case of a fault, an error message with short description of the fault is shown immediately at the LCD.



Fig. Error messages

The error message begins with character E followed by error's number. If the error is connected with a defect of a module than it is followed also by character M and the number of the module. After pushing button the flowmeter returns to value display mode

and at the same time the error message is saved to last error register. During the indication of the error message, the flowmeter is measuring. In case of error E-7, E-8 and E-13, the flowmeter indicates 0 if the mentioned error message is not forbidden in the menu.

Error messages are listed below together with recommendation how to repair.

- E0: No error
- E1: EEPROM Checksum error

*Checksum error saved in the module - re-check data in the module and save*

*again*

## E2: Stack overflow

*For module „B“ in pulse mode - the time constants are too long, the flow rate is higher than it is possible to send pulses, stack overflow of un-sent pulses - change pulse length and space length or volume for 1 pulse*

## E3: Frequency limit exceeded

*For module „B“ in frequency mode, it is required higher output frequency than the module is able to send, flow rate is higher than it was assumed - set higher flow rate value for 1kHz.*

## E4: Power fail

Appears for short after power fail

**E5: Old software**

For proper operation of the module is required newer firmware version than it is installed in the convertor – upgrade firmware.

**E6: Can't use this mode**

For module B placed in position 6 and 7 is not possible to use frequency mode (it is possible only in position 4 and 5) – change the position of the module or change the mode to pulse.

**E7: Sensor loop disconnected**

No current to the coils – for remote version check cables and terminals

**E8: Empty pipe**

For modules F2 and F3, indicates that the controlling electrode is not submerged

**E9: Low medium conductivity**

For modules F1 and F3 in electrodes cleaning mode, no current in the electrodes, sensor is not submerged, electrodes are furred or low medium conductivity - clean the sensor

**E10: MBus conflict**

Module D3 – exist two stations M-Bus with same address – change the setting of module D3

**E11: Current output overrange**

For module A it is required higher output current than 20mA, flowrate is higher

than it was assumed – set higher flow rate value for  $I_{max}$

**E12: Serial line fail - communication error**

Communication module C1 or Dx sends data but does not receive confirmation for receipt of data – check cables, could be caused also by external interference, high capacity of the cables or too long cables.

**E13: Sensor signal overrange**

Signal from the sensor is overrange of the convertor - electrodes are not submerged or there is short circuit of the cables – check the sensor and the cables

## User outputs – plug-in modules

Flowmeter converter in basic configuration contains the power supply and boards required for measurement functions. All other inputs, outputs and display units can be added as plug-in modules. Customer pays only for features that he really uses. At the same time,

this concept allows using of various types of inputs and outputs tailored to customer needs.

Following table and figure indicate positions and functions of individual modules.

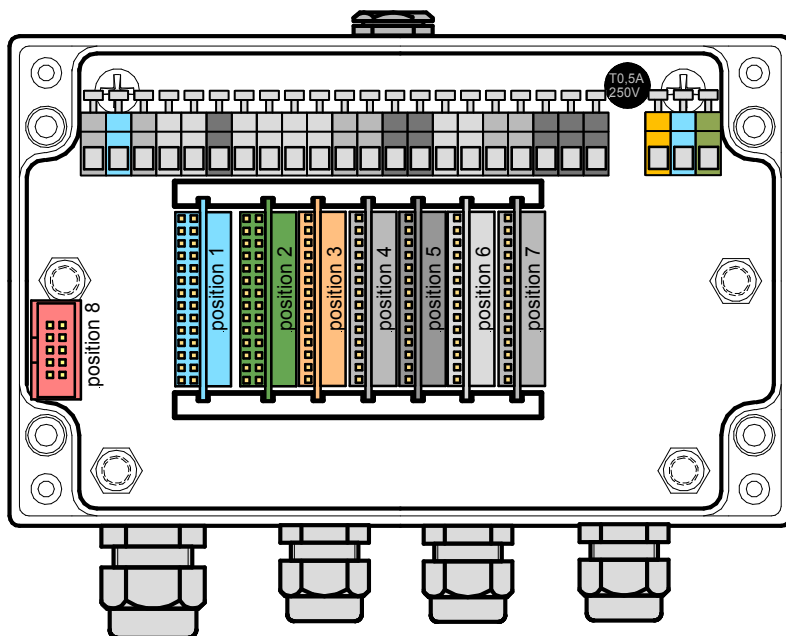

Fig. Module positions

Position	Modules	Terminals
1	S1 sensor input module, always plugged in	A, B, C, D, E
2	F1-F3 module for sensor full pipe checking and electrode cleaning	1, 2, 3, 4, 5,
3	M1 extended memory module of measured data	-
4	A4,A7 passive current output 4 - 20 mA B1-B5 binary outputs incl. frequency up to 12 kHz E1 binary input	6, 7
5	A4, A7 passive current output 4 - 20 mA B1-B5 binary outputs incl. frequency up to 1,2 kHz E1 binary input	8, 9
6	A4, A7 passive c.o. B1-B5 except for frequencies, C1, D1, D2, D3, G1, H1 data communication E1 binary input	10, 11
7	A1-A3, A5, A6 active current output A4, A7 passive c.o. B1-B5 except for Frequencies E1 binary input	12, 13
8	V1 display and keypad	10 pin connector

Tab. Module positions

# Parameter setting

The magnetic flowmeter converter can be configured in two ways, as required: either using a PC connected via serial interface, or using keys.

Press **⏏** to switch the display to programming mode. Programming mode is password protected against unauthorized access. Correct password (4-digit number) must be entered to obtain access to main menu. Password of a new instrument is always set to 0000.



Fig. Enter password

This is also initial value displayed as default. Simply confirm it to enter in menu.

Password can be changed as required before you leave the programming mode.

Warning! You can switch the instrument to data display mode anytime by pressing **⏏** and check current parameter settings. However, the instrument is not password protected against unauthorized access until you enter EXIT command. Programming runs in background and with only a few exceptions has no influence to measurement.

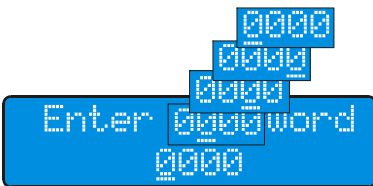

Fig. Cursor movement

**▶** key moves cursor to the right. When the utmost right position is reached, the cursor returns to the left.

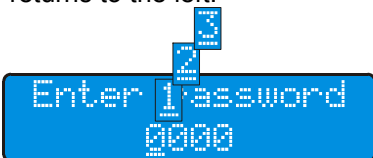

Fig. Character changing

**▲** key changes character at cursor position. When the last available character is reached,

system returns to the first available character.

Character set is always selected with regard to possibility of character occurrence in text: [0..9] for integers, [0..9,- , .] for decimals and complete alphabet for text variables (including Czech characters).



Fig. Status message

Confirm your selection by **⏏** key to finish editing.

A status message will be displayed. If your password is not accepted, program returns to editing mode. If correct password was entered, you will get to main menu.

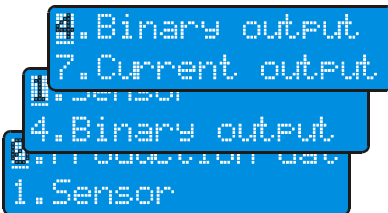

Fig. Movement in menu

Use **▲** to move in menu. This key moves the lower line item to upper line. In all menus, the upper line with blinking first character is always the active line.

Press **⏏** to enter in submenu or to edit item. Pressing **▶** in submenu brings you always back to previous menu ("Escape" function). If you are in main menu, pressing of this key will offer exit from programming mode.

## Menu legend

Some menu items can be used only for viewing and do not allow change of values.

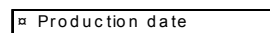

Fig. Read only

Press **⏏** to return to previous menu.

Other menu items can be used to enter value directly.



Fig. Enter value

When you enter the value and press **⏏**, a status message will be displayed.

If the value entered is accepted, press any key to return to previous menu or to edit next item.

If the value entered is out of range, an error message will be displayed; press any key to edit the value.

In some cases, one of listed values has to be selected.

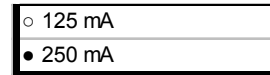

Fig. Selection of one value

Use **▲** to select required item. When the required value is in the upper line, press **⏏** to confirm your selection. A status message will be displayed to confirm that your selection has been accepted. Press any key to return to previous menu or to edit next item.

In some cases, more of listed values can be selected.

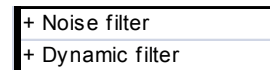

Fig. Selection of more items

There is a sign "+" (indicating that the item is selected) or "-" (indicating that the item is not selected) before each of items.

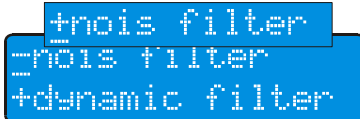
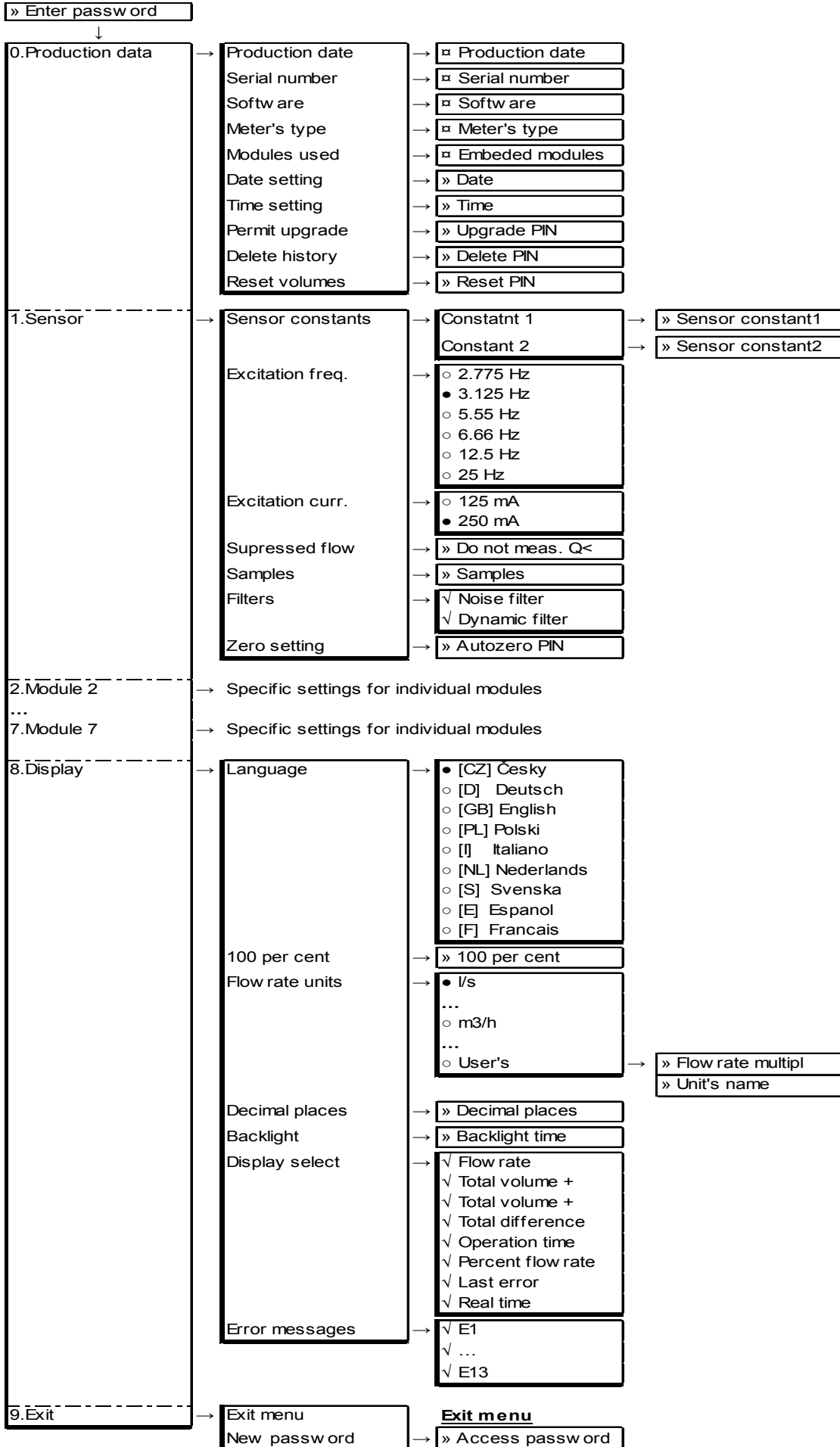

Fig. Selection of more items

Press **▶** to change selection for the item displayed in the upper line. Press **⏏** to finish your selection. A status message will be displayed to confirm that your selection has been accepted. Press any key to return to previous menu.

# Flowmeter menu



## 0. Production data

This submenu relates to the flowmeter converter.

- **Production date** – of converter
- **Serial number** – of converter
- **Software** – current software version
- **Type of meter** – type number of flowmeter converter
- **Modules used** – types of currently used modules

(Above listed items are only for information and user cannot change them)

- **Date setting** – setting of current date
- **Time setting** – setting of current time
- **Upgrade enabled** – a new firmware version can be uploaded after entering PIN
- **Delete history** – archives will be deleted after entering PIN
- **Reset volumes** – All totalizers will be reset after entering PIN

## 1. Sensor

This submenu relates to the sensor.

- **Sensor constants** – sensor calibration constants
- **Excitation frequency** – of sensor coils
- **Excitation current** – of sensor coils
- **Suppressed flow rate** – when flow rate is lower than this value, it is considered for zero. This setting is used to suppress creeping flows.
- **Number of samples** – for floating averaging that filters measured flow rate value. Higher number of samples

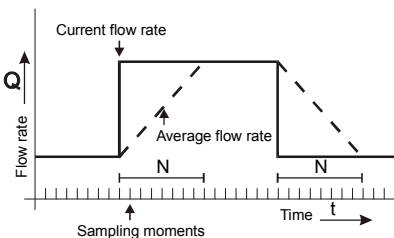

Fig. Averaging

provides more stable flow rate value, however it increases time constant and

causes delayed reaction to flow rate changes.

### •Filters

◆ **Noise filter** partially reduces jump changes but mainly removes lower periodical interference. Transient edges are rounded as can be seen in figure of response to unit jump. The filter is applied already on input and thus influences immediate flow rate value and cumulated volume calculated from it. The noise filter introduces only negligi-

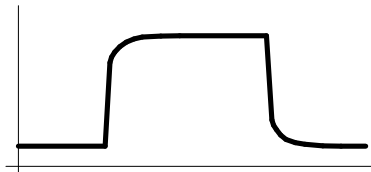

Fig. Noise filter

ble delay (about 0.3 sec) and can be used almost at all circumstances.

◆ **Dynamic filter** reduces rapid jump changes of flow rate. It protects very effectively against high short peaks caused by interference. Unlike averaging, dynamic filter cuts input signal and interference is not included in cumulated volume. It can however cause delay of flow rate jump change indication. This fact should be considered if the flowmeter is used for dosing applications. Response to unit jump can be seen in figure.

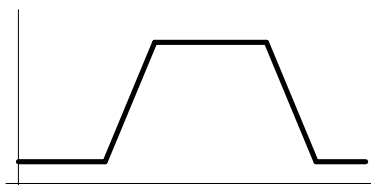

Fig. Dynamic filter

## 8. Display

This submenu relates to data shown on the display.

- **Language** – language of displayed data. You can select from 9 languages.
- **100 per cent** – 100 % flow rate for bar diagram. It is

used only for percentage bar diagram display; it is not meant as range of the meter.

• **Flow rate units** – You can select from 12 preset units or add your own user defined unit. In such case you have to enter *multiple of flow rate* in l/s and a *unit name*.

• **Decimal places** – Number of decimal places of displayed flow rate. You can enter 0-4 decimal places. If 5 places are entered, number of decimal places will be dynamically changed to 4 valid decimal places.

• **Time of backlight** – Time of display backlight in seconds. When you press any key, backlight of display goes on. When time period set in seconds expires since you pressed the last key, the backlight goes off. You can set time period from 1 to 254 seconds. If you set 0, backlight will never be on. If you set 255, the display will be permanently backlit.

• **Displayed values** – Defines what items will be displayed. You can select any of available items. These will be alternately displayed on the flowmeter display. Press  to alternate displayed values.

• **Error messages** – Enable or disable displaying of individual error messages.

## 9. Exit

• **Exit menu** – When you finish editing, you have to exit menu because only after that settings are permanently stored in module memories. If you will not exit the menu and power failure occurs, previously entered settings will be loaded. Also access to menu is password protected only when you exit menu.

• **New password** – You can change the access password before you finish your editing.

# Current output modules A1 – A4

Modules A – analog current output – are used for flow data transmission. There are 4 different types available with various ranges, accuracy and functions.

Outputs of A1 to A3, A5 and A6 modules are active (forced current) and are galvanically isolated from other flowmeter parts. Outputs can be loaded up to 1000 Ω. They can be plugged only in position 7.

<b>A1</b>	Range 0(4)..20 mA Resolution 12 bit Accuracy ± 0.2%, ± 0.2mA Active - replaced by A5
<b>A2</b>	Range 0(4)..20 mA Resolution 16 bit Accuracy ± 0.1%, ± 0.1mA Active - replaced by A5
<b>A3</b>	Range 4..20 mA Resolution 16 bit Accuracy ± 0.1%, ± 0.1mA Active - replaced by A6
<b>A4</b>	Range 4..20 mA Resolution 16 bit Accuracy ± 0.1%, ± 0.1mA Passive - replaced by A7
<b>A5</b>	Range 0(4)..20 mA Resolution 16 bit Accuracy ± 0.1%, ± 0.1mA <b>Active</b>
<b>A6</b>	Range 4..20 mA res. 16 bit Accuracy ± 0.1%, ± 0.1mA <b>Active</b> - compatible with module H1 ( HART )
<b>A7</b>	Range 4..20 mA res. 16 bit Accuracy ± 0.1%, ± 0.1mA <b>Passive</b> - compatible with module H1 ( HART )

A4 and A7 modules have passive current output (it has to be powered externally) and are also galvanically isolated. Unlike A1-A3, A5, A6 modules, it can be plugged in positions 4, 5 and 6.

Depending on flow rate (see diagrams), output can work in 5 modes:

- 0..+Q output
- 0..-Q output
- I|Q| output
- Q..+Q output
- Fixed current 0..20

The first four modes generate output current depending on flow rate, the fifth mode enables direct entering of current. Following 4 ranges can be selected for all modes (except for the fixed current mode):

- 0..20mA output
- 4..20mA output
- 0..10mA output
- 0.5mA output

A3, A4, A6 and A7 modules can work only with range 4..20 mA.

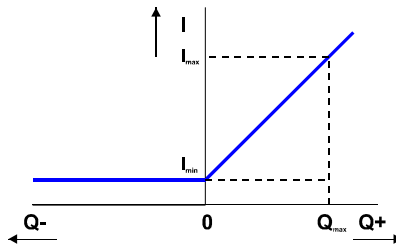

Fig. 0..+Q output

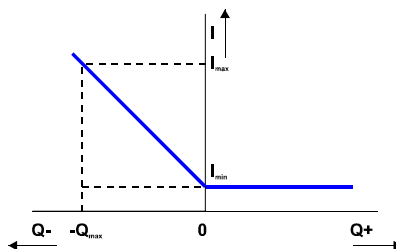

Fig. 0..-Q output

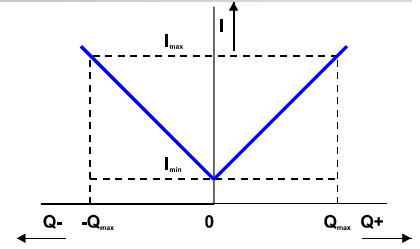

Fig. I|Q| output

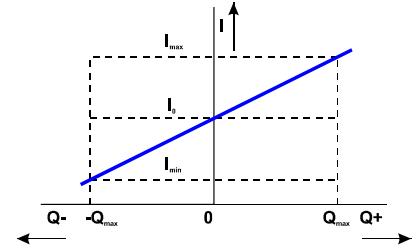
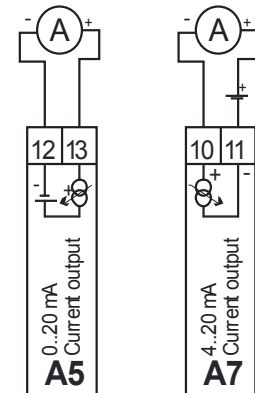

Fig. -Q..+Q output

Modules A6 and A7 enables with module H1 (Bell 202 modem) to communicate through current loop with a protocol compatible with HART (only Universal Commands)



Range	0..20mA			4..20mA			0..10mA			0..5mA		
Flow rate / current	-Q <sub>max</sub>	0	Q <sub>max</sub>	-Q <sub>max</sub>	0	Q <sub>max</sub>	-Q <sub>max</sub>	0	Q <sub>max</sub>	-Q <sub>max</sub>	0	Q <sub>max</sub>
0..+Q output	0	0	20	4	4	20	0	0	10	0	0	5
0..-Q output	20	0	0	20	4	4	10	0	0	5	0	0
0.. Q  output	20	0	20	20	4	20	10	0	10	5	0	5
-Q..+Q output	0	10	20	4	12	20	0	5	10	0	2,5	5

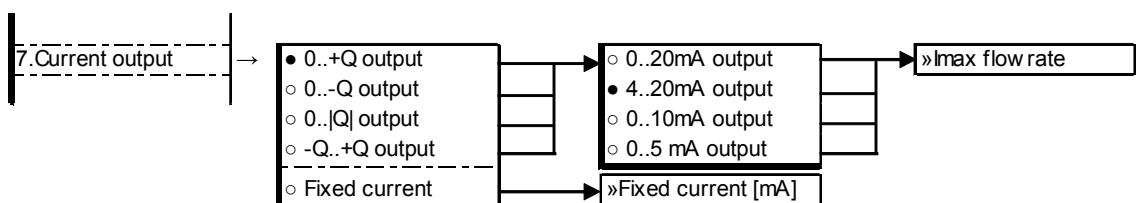

Fig. Menu structure of A modules

# Binary output modules B1 - B5

Flowmeter converter can control up to 4 multifunctional binary outputs in positions 4 – 7. Following table indicates differences between individual modules:

<b>B1</b>	Passive (max 4 kHz) Max. voltage 350 V <sub>p-p</sub> Max. perm. current 120 mA Max. pulse current 300 mA Resistance 27 Ω
<b>B2</b>	Passive (max 12 kHz) Max. voltage 60 V <sub>p-p</sub> Max. perm. current 300 mA Max. pulse current 500 mA Resistance 5 Ω
<b>B3</b>	Active Voltage 5 V Max. current 10 mA Max. frequency 12 kHz
<b>B4</b>	Active Voltage 24 V Max. current 40 mA Max. frequency 12 kHz
<b>B5</b>	Relay contacts Max. voltage 250 VAC Max. current 1 A

Tab. Binary output modules

Outputs can work as pulse, frequency or status outputs. Individual functions are explained in detail in following section.

## Binary module functions

### •Normally closed/open

These modes are used for service purposes.

### •Pulse outputs (not)

In this mode, a pulse is generated immediately after preset volume has flowed. Pulse generation is determined by three factors: pulse length “ $t_u$ ”, mini-

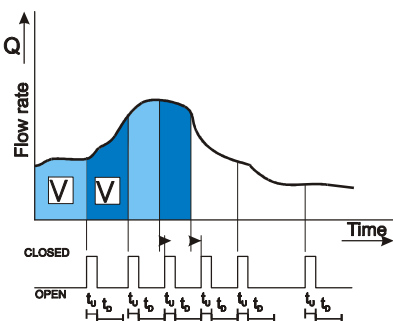

Fig. Pulse generation

mal delay between two pulses “ $t_D$ ” and volume per pulse “ $V$ ”.

Flow rate values are time integrated. Immediately after preset volume per pulse has flowed, the pulse of length  $t_u$  is generated. After the pulse, there is a delay of length at least  $t_D$ . If the delay expires and the preset volume has not flowed again, the output remains inactive; otherwise, another pulse and delay are generated immediately. If the preset volume flows through sooner than the previous pulse is finished, the unsent pulse will be stored in a buffer with maximum capacity of 255 pulses. If buffer overflow occurs, an error message will be generated. It follows from above mentioned that parameters of pulse output should be set such that expected pulse frequency cannot exceed limit frequency determined by pulse length and delay.

**It applies: Maximum pulse frequency [s<sup>-1</sup>] = 1 / (t<sub>u</sub> + t<sub>D</sub>)**

Volume per pulse can be set in range from 1 to 10<sup>9</sup> ml with 1 ml step, i.e. from 1 ml to 1000 m<sup>3</sup>. Delay and pulse lengths can be set in range from 10 ms to 2550 ms with 10 ms step. It follows from above mentioned that the maximum pulse frequency is 50 s<sup>-1</sup>.

Pulses can be generated in three modes depending on flow rate, and pulse polarity can be set (output is closed during pulse or open in not modes).

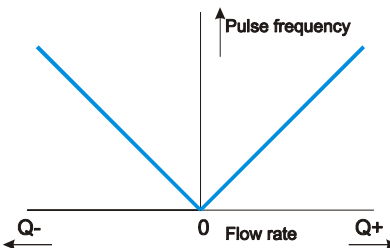

Fig. IQI pulses

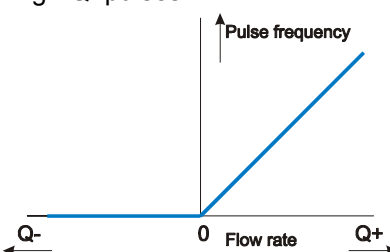

Fig. Q+ pulses

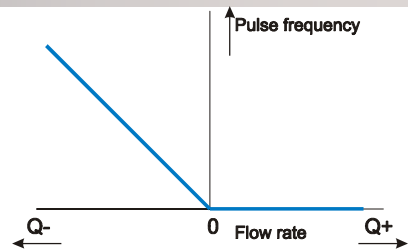

Fig. Q- pulses

### •Frequency outputs

In this mode of operation, frequency is generated on output modules. Pulse to delay ratio is always 1:1. Warning! Only two frequency generators in positions 4 and 5 are available for the converter. This function is blocked in positions 6 and 7. Maximum frequency in position 4 is 12 kHz and in position 5 only 1.2 kHz. If these limit frequencies are exceeded, output frequency will be limited and an error message will be generated.

Frequency outputs can work in three modes of frequency dependence on flow rate.

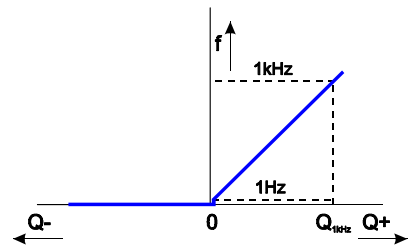

Fig. Q+ frequency

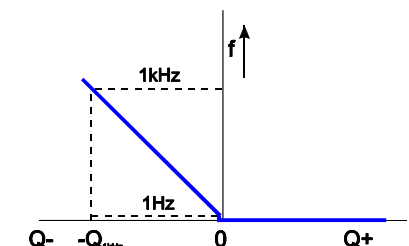

Fig. Q- frequency

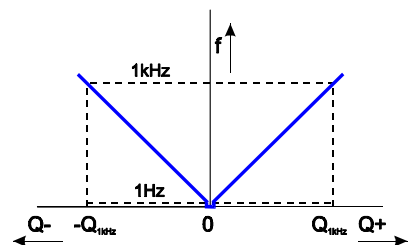

Fig. IQI frequency

Setting is done by selecting of flow rate corresponding to 1 kHz output frequency.



Fixed frequency mode is used for service purposes. Required frequency is set directly in Hz in range 1-120000 Hz in position 4 and 1-1200 Hz in position 5.

• **Negative/non-negative flow rate**

This mode is used for flow direction differentiation. Output is closed/open for negative flow rate.

• **Failure occurred/not occurred**

If failure with mode set to active (see *error messages*) occurs, the output closes/opens for at least 5 seconds. If failure persists, output is closed/open for whole period of failure duration.

• **Limit flow rate exceeded/undergone (not)**

If flow rate is higher/lower than limit value set, the output closes (opens). When flow rate returns to limits, the output opens (closes) again taking in account preset hysteresis. This function

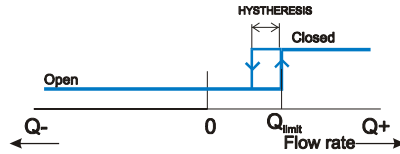

Fig.  $Q > Q_{limit}$

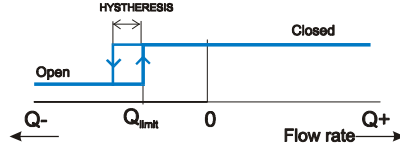

Fig.  $Q < Q_{limit}$

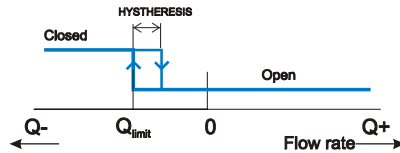

Fig.  $|QI| > Q_{limit}$

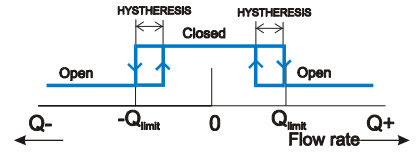
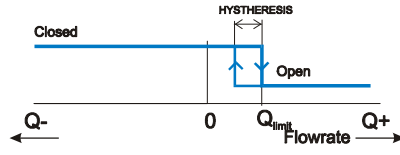

Fig.  $|QI| < Q_{limit}$

works in four modes of dependence on flow rate with output polarity differentiation.

• **Electrode cleaning/no cleaning**

The output is closed/open during cleaning.

• **Batch Opened**

• **Batch /Opened**

Output is switched on / switched off during the batch running. It is possible to set the advance of the output before batch ending. Advance could be set by time or volume. Detailed information is given in chapter Batching.

• **Batch Stop pulse**

• **Batch Stop /pulse**

Output generates pulse for ending of the batch. It is possible to set pulse length (10ms - 2,5s) and pulse advance before batch ending. Advance could be set by time or volume. Detailed information is given in chapter Batching.

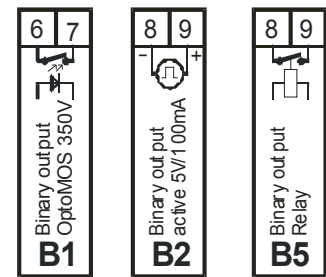
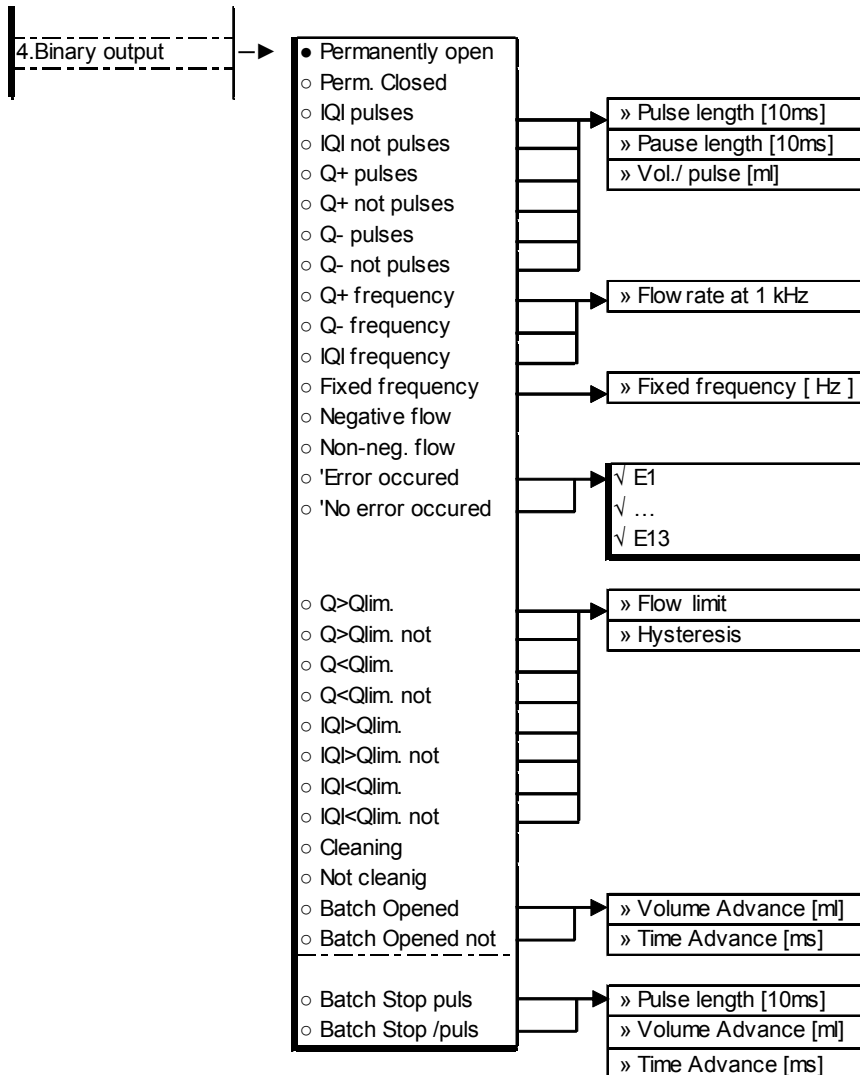

Fig. Terminal connection

Fig. Menu structure of B modules

# C1, D1, D2 and D3 modules

Modules C1, D1, D2 and D3 are used for data communication. All these modules are galvanically isolated from flowmeter circuits. They can be installed only in position 6 and their signals are output to terminals 10 and 11. Interface RS232 is the only exception, as it needs 3 wires.

<b>C1</b>	RS232
<b>D1</b>	RS485 (MODBUS)
<b>D2</b>	0/20mA data current loop
<b>D3</b>	M-BUS
<b>G1</b>	GSM modem
<b>H1</b>	HART modem (with A6,7)

## C1 – RS232 interface

It is used primarily for service purposes, because maximum cable length from the converter to a computer is 15 meters and only one converter can be connected to a single link.

Connection to the computer equipped with RS232 interface is done using an included cable. Thread one end of the cable through a cable bushing and connect it to 3-pin connector behind terminals 10-11. The other end of the cable is equipped with CANON 9M connector. This ensures leading of RS232 interface signals out of converter box while protection level IP66 is maintained.

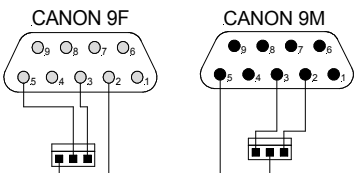

Fig. RS232 cable connection

The interface is connected to the computer using a crosslink cable Laplink 9F-9F.

## D1 – RS485 interface

It is used for permanent connection of multiple converters to the computer. It enables connecting

of up to 31 stations in a communication network using a twisted pair link cable with total length of 1200 meters. Number of stations and length of cables can be increased by using re-

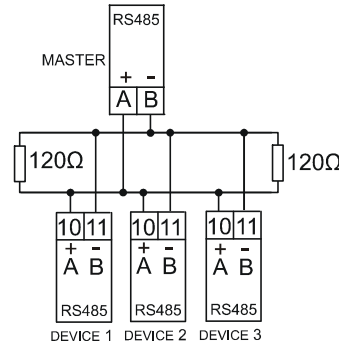

peaters. Stations are connected to the link in parallel. The most distant ends of line have to be equipped with terminating resistors 120 Ω.

When setting stations, be sure to set the same baud rate for all of them and to set a unique address for each of them. MASTER address is always set to "0" and addresses of individual stations can be set in range 1-254.

## D2 – Data current loop interface 0/20 mA

It is used for permanent connection of multiple converters to the computer. It enables connecting of multiple stations on long distances. Data transfer via current coding 0/20 mA is highly resistant against interference and is suitable for industrial environment.

Individual stations are connected in series. Disadvantage of this configuration is that if one station fails, then whole network breaks down.

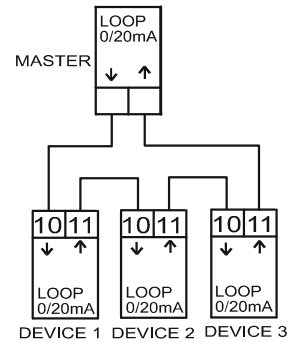

Fig. Data current loop 0/20 mA network connection

## D3 – M-BUS interface

Standard M-Bus (Meter-Bus) is designed for applications of data acquisition from various media consumption meters. It enables connecting of many devices (hundreds of them) on distance of several kilometers.

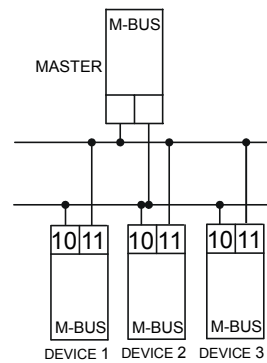

Fig. M-Bus network connection

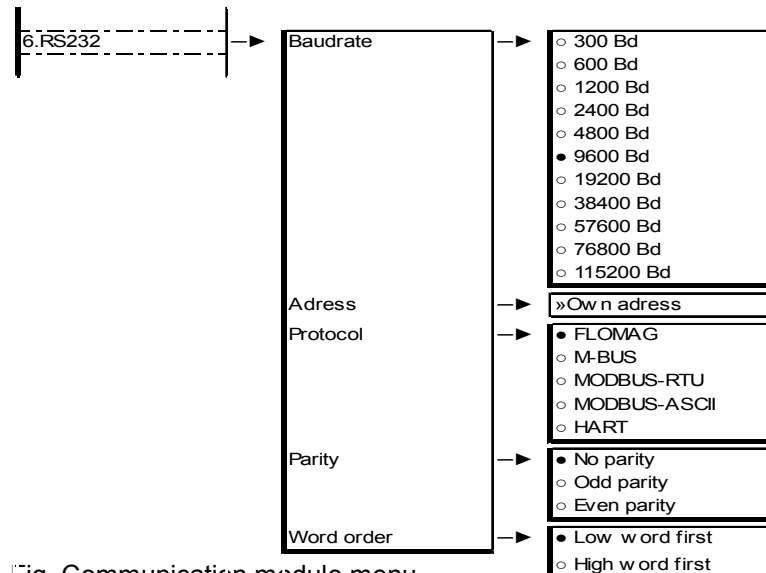

Fig. Communication module menu

# Modul E1

Module E1 is galvanically separated active binary input for nonvolatile contacts or open collector. Input has SW transient immunity. It is necessary min pulse length of 60 ms for switching .

## Functions of the binary input

- **Switch Off**
- **Batch Start**  
Starts the batch (see section



Fig. Terminal connection

Batching).

- **Batch Hold**  
Stops and holds the batch. Counted batch can be continued after restarting it (see section Batching).
- **Batch Stop**  
Asynchronously finishes the batch and sets again the preset

batch volume (see section Batching).

- **Reset Volumes**  
Enables reset of the chosen totalizers and working time.
- **Cleaning Start**  
Starts electrochemical electrodes cleaning in modules F1 or F3 (requires plug-in modules

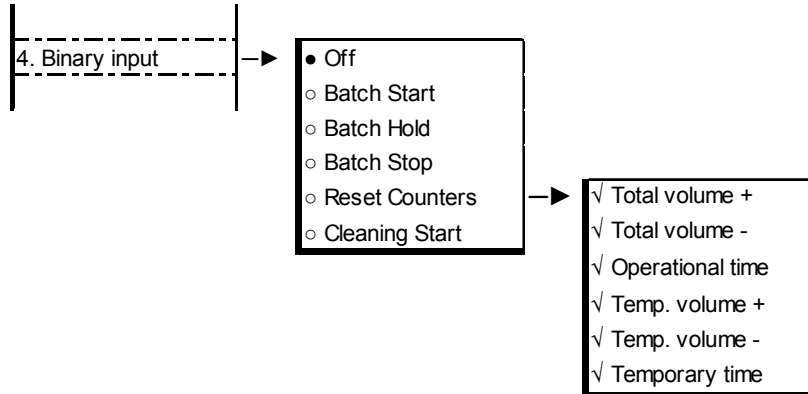

Fig Menu of module E1

# F1, F2 and F3 modules

F1 – F3 modules are used for full pipe check and for electrochemical cleaning of electrodes.

## F1-Electrochemical electrode cleaning module

<b>F1</b>	Electrochemical electrode cleaning module
<b>F2</b>	Empty pipe detection module
<b>F3</b>	Module with combined functions F1+F2

### ule

During operation of the flowmeter, a non-conductive layer can be formed on sensor electrodes. This layer increases contact resistance between electrodes and measured fluid and results in lower measurement accuracy.

F1 module enables measuring electrode cleaning without need of sensor deinstallation. The method is based on electrochemical effect. Alternating voltage is connected to electrodes and the deposited layer dissolves in liquid. This cleaning should be performed periodically.

cally.

The cleaning cycle takes 1 minute. During cleaning, no real measurement is performed. Flow rate measured before start of cleaning is simulated. Cleaning cycle duration can be indicated using binary outputs. Running cleaning process is indicated on display by moving full character on upper line.

The instrument offers several possibilities of cleaning cycle start:

If ONCE is selected, a single cleaning cycle is immediately performed and then the instrument returns to Off mode.

If AFTER SWITCH-ON is selected, the cleaning cycle will be always started if power supply

OFF
Only once
During power ON
Periodically

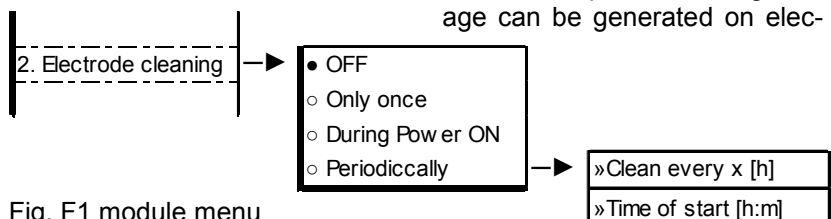

Fig. F1 module menu

is switched on. Option PERIODIC starts cleaning in regular intervals that can be set by user in range from 1 to 255 hours. Timer starts counting after time value is entered. Starting time of cleaning can be set to match to real time. It makes sense only if cleaning period is set in multiples of 24 hours. Then cleaning will be performed always in preset time. F1 module has no wires connected to the terminal block.

## F2 - Full pipe check module

Correct measurement of flow rate by the magnetic flowmeter is conditioned by full flooding of the whole sensor cross section by measured liquid. If flooding is only partial, the magnetic flowmeter will indicate flow rate higher than real. However, if both electrodes are not immersed in liquid, interfering voltage can be generated on elec-

trode wires and the flowmeter can indicate totally random values. To avoid this situation, the sensor can be equipped with checking electrode and converter with full pipe check module. The module continuously checks if the checking electrode

is immersed in liquid. If it is not, an error message will be displayed and zero flow rate will be

indicated. The checking electrode is connected to terminal 1. This electrode cannot be retrofitted and should be considered on initial order.

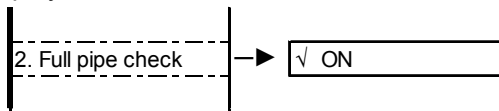

Fig. F2 module menu

### F3 - Electrode cleaning and full pipe check module

This module combines functions of modules F1 and F2. Besides different menu, all

above mentioned information applies for this module.

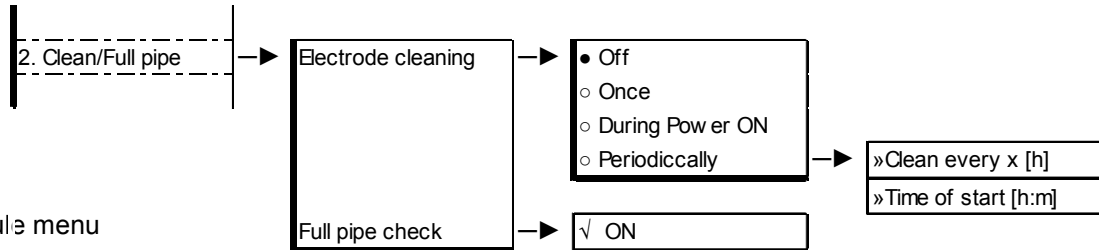

Fig. F3 module menu

## Module G1

Module G1 is a GSM modem enabling sending by SMS messages on preset numbers, in preselect intervals (or on re-

quest) information about the status of the flowmeter and the measured values. Detailed description of the module func-

tions is given in a separate document.

## Module H1

Module H1 is Bell 202 modem, extensioning the function of modules A6 and A7. It enables data communication through current loop with a pro-

ocol compatible with HART (only Universal Command). Assigning the variables of the flowmeter is following:

- PV - Flow rate [ l/s ]
- SV - Current flow rate [ l/s ]
- TV - Total volume + [ m<sup>3</sup>/h ]
- QV - Total volume - [ m<sup>3</sup>/h ]

## Batching

Batching mode is used for control of external equipment ( valves, pumps) in order to measure repeatedly the preset volume (batch). It is not recommended for batching of very small volumes. The period of one batch has to be min 30 s.

Electromagnetic flowmeter FLOMAG3000 has very sophisticated batching functions. It enables simple batching with manual starting but also fully automatic batching by remote control.

Batching process is divided into 4 phases. Single phases are distinguished on LCD by a symbol in square brackets. Upper line shows remaining volume in ml to the end of the



Fig. Batching phase 0

batch. Bottom line shows help for manual batch control.

### Phase 0 - Stop

During phase 0 outputs are inactive, no batching runs, waiting for start of the batching process. Manual start is realized by holding button and simultaneous pushing of button or from outside with the help of module E in Batch Start mode. During that phase the batch volume is set. To enter edit mode it is necessary to hold button and simultaneously push button .



Fig. Batching phase 1

### Phase 1 - Hold

Phase 1 temporary batch in-

terruption. Outputs give signal for interruption of the batch (close valve, switch off pump). Counted batch could ve continued again by manual start choosing Restart or from outside with the help of module E in Batch Start mode. It is possible also to abort the batch by choosing Reset or from outside with the help of module E in Batch Stop mode.



Fig. Batching phase 2

### Phase 2 - Run

During that phase runs the measuring of the batch (valve is open, pump is running). This mode can be interrupted using Phase 1 (Hold) activated manually or with the help of module E in Batch Stop mode. It is possible also to abort it choosing Re-

set or from outside with the help of module E in Batch Stop mode. During this phase there is no reaction to external signal Batch Start. If there is no any preset outputs' advance, after flowing of the set batch volume comes switching to phase 0 (Stop). Outputs will send signal for batch stop (switch off pump, close valve). Because of the late reaction to the output signal a partial overflow of the set batch volume will take place and display will show negative volume. That's why it is suitable to send a signal for batch stop in advance as it is described below.

### Phase 3 - Finish

In practice we need to send a signal for batch stop in advance. It is mainly because of the inertia of the technical equipment (valves, pumps). Phase 3 represents time when one of the outputs have sent in advance signal for batch stop. According to the ability to forecast exactly the advance, the batch can slightly overflow which means to go to phase 0 or the batch will not finish and will go to phase 3. In this case it is possible to go to phase 0 by choosing Reset or from outside with the help of module E in Batch Start mode. In the same time takes place presetting of the volume batch according to the preset value. Second possibility is to start new batch choosing restart or from outside with the help of module E in Batch Start mode.



Fig. Batching phase 3

The binary outputs in batch mode enable setting of the advance by volume when the output is activated, if the remaining batch volume is smaller than the preset volume advance. Second possibility is to set time advance when the flowmeter's logic calculates what time remains to the end of the batch according to the actual flow. Both possibilities can be combined. Output reacts to the

event which first takes place. The advantage is that you can set different advance for each output. This way it is possible to switch off a pump and later close the valve.

Binary outputs have 4 options for setting in batch mode. They

can indicate condition when runs the batch (phase 2) or to send a pulse for batch finish/interruption. Pulse length can be set from 10 ms up to 2550 ms, step 10 ms. Both output modes can work in both polarities.

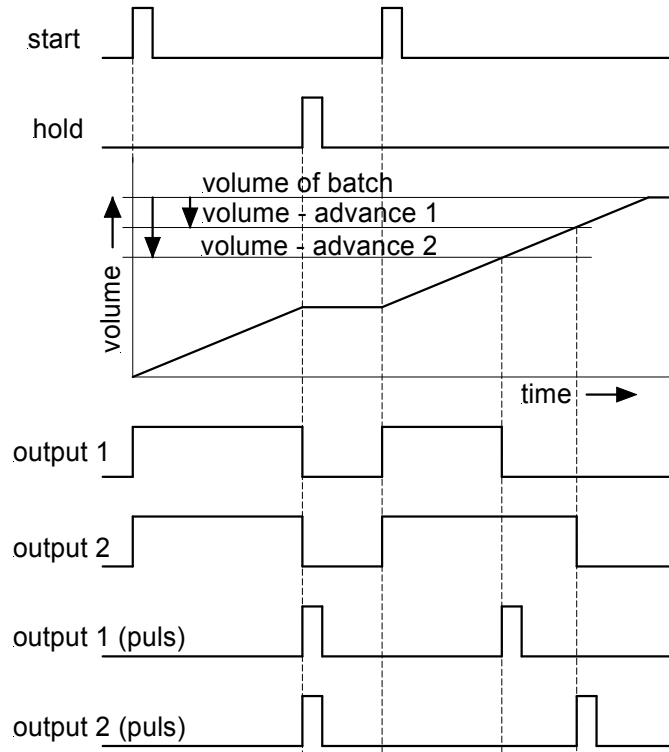

Fig. Batch running

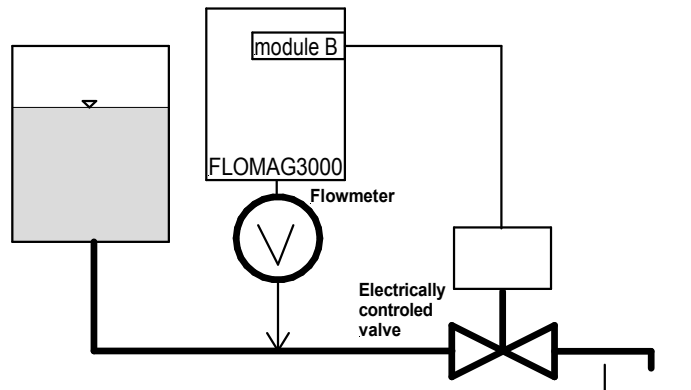

Fig. Minimum batching option

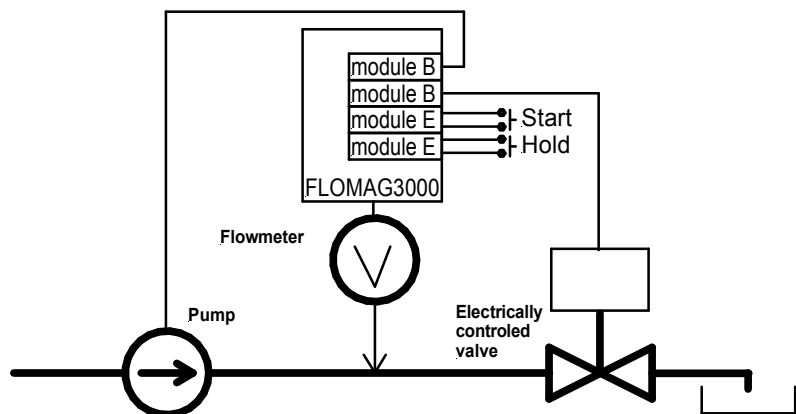
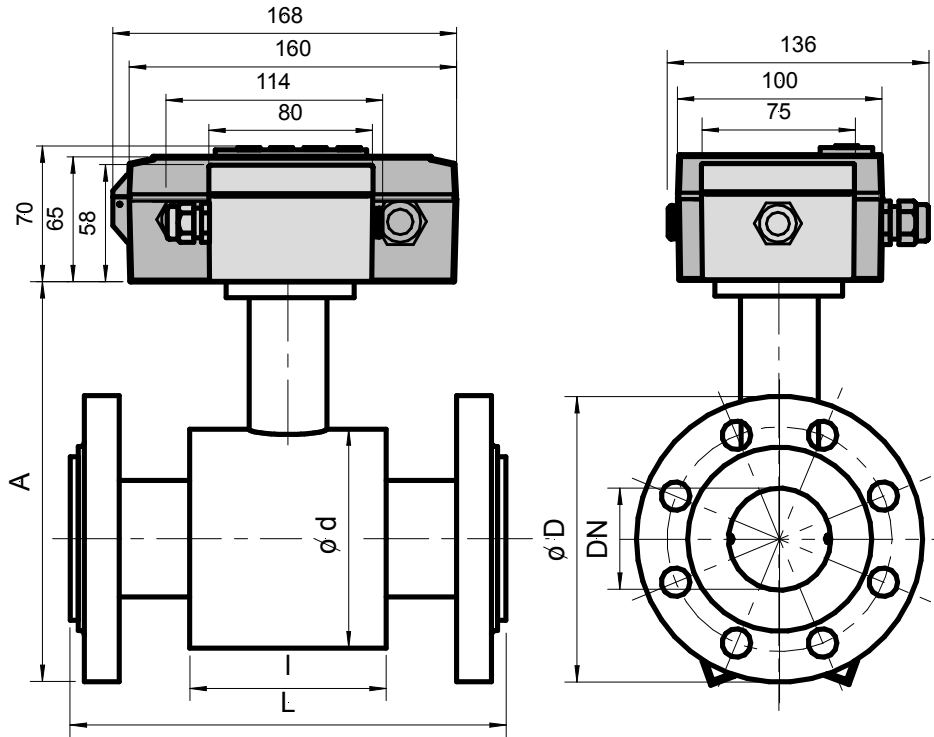

Fig. More complex batching option

**Flowmeter dimensions – flanged versions “P”, “PDIN” and “PANSI”**



DN		PN	D	d	A	L*		I	Weight**
[mm]	[inches]					ISO 13359 EN 14154	Optional		
15	1/2	16	95	62	164	200	138	66	3.5
20	3/4	16	105	62	170	200	138	66	3.5
25	1	16	115	72	180	200	215	96	3.5
32	1 1/4	16	135	82	199	200	215	96	6
40	1 1/2	16	145	92	209	200	215	96	7
50	2	16	160	107	223	200	215	96	8
65	2 1/2	16	180	127	244	200	215	96	10
80	3	16	195	142	260	200	215	96	12
100	4	16	215	162	280	250	215	96	16
125	5	16	245	192	310	250	305	126	21
150	6	16	280	218	340	300	305	126	28
200	8	16	335	274	398	350	380	211	35
250	10	10	405	370	480	450	380	211	42.5
300	12	10	440	420	535	500	515	320	55
350	14	10	500	480	584	550	515	320	65
400	16	10	565	530	642	600	515	320	94
450	18	10	565	530	642	600	515	320	94
500	20	10	670	640	752	600	515	320	122
600	24	10	780	760	870	600	615	320	158
700	28	10	895	880	990	700	715	420	230
800	32	6	1010	980	1100	800	815	420	325
900	36	6	1115	1040	1185	900	815	520	420
1000	40	6	1220	1140	1290	1000	1015	520	510
1200	48	6	1455	1340	1510	1200	1015	520	680

\* Standard construction length meets ISO 13359, different construction lengths should be indicated, e.g. "l=215"

Construction length tolerance for DN≤200: +0/-2 mm  
DN>200: +0/-3 mm

\*\* Weight of PDIN sensor without converter and terminal box  
- weight of terminal box has to be added for remote version – 0.25 kg  
- weight of converter has to be added for compact version – 0.9 kg

Type acc. to Flange	DN	PN	Flange dimensions meet
PDIN	15..1200	2.5, 6, 10, 16, 25, 40, 63	EN 1092-1 BS 4504
PANSI	1/2"-.40"	150lb, 300lb	ASA / ANSI B 16.5

**Protection:** compact version **IP66**, remote version **IP67** (optionally **IP68**)  
**Electrodes:** **Ss** – stainless steel AISI316Ti, **Ha** - Hastelloy C22, **Ti** - Titanium, **Pt** – platinum  
**Lining:** **TG** – hard rubber, **MG** – soft rubber, **NG** – resistant rubber, **PTFE** – Teflon  
**Accessories:** optional for a surcharge – grounding rings or grounding electrodes for nonconductive tube

## Flowmeter dimensions – wafer version “B”

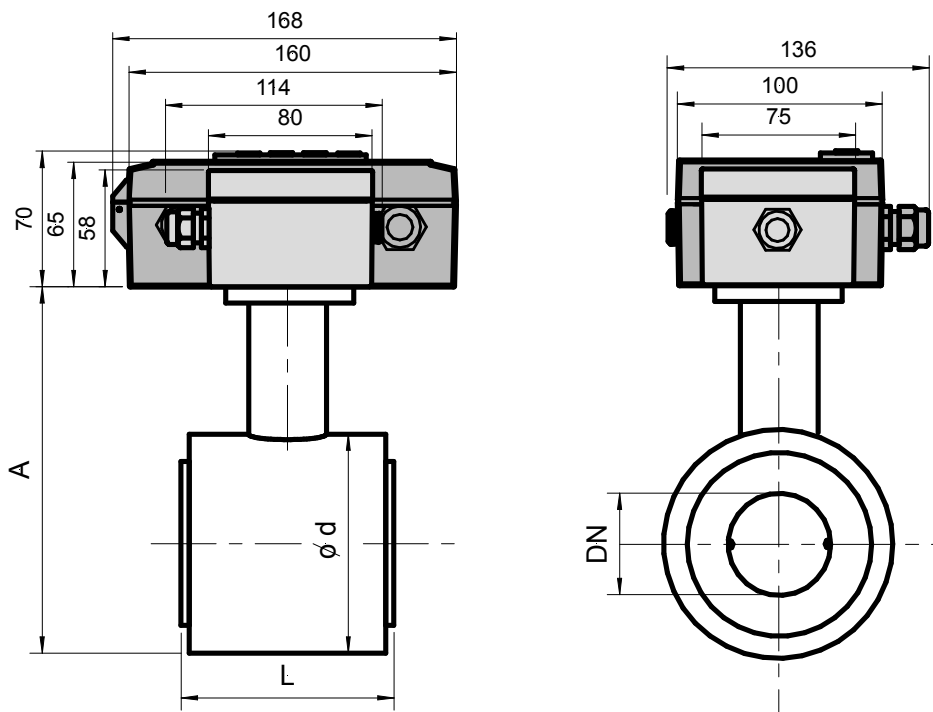

DN		D	A	L*			Weight**
[mm]	[inches]			lining TG, MG [mm]	lining NG [mm]	lining PTFE [mm]	
10	3/8	62	145	-	-	62	0.8
15	1/2	62	145	74	72	70	0.9
20	3/4	62	145	74	72	70	1.1
25	1	72	158	104	102	100	1.5
32	1 1/4	82	168	104	102	100	1.8
40	1 1/2	92	179	104	102	100	2.2
50	2	107	192	104	102	100	2.8
65	2 1/2	127	212	104	102	100	3.2
80	3	142	227	104	102	100	3.5
100	4	162	247	104	102	100	4
125	5	192	277	134	132	130	6
150	6	218	303	134	132	130	8

\* Standard construction length meets ISO 13359, different construction lengths should be indicated, e.g. “l=215”

Construction length tolerance: +0/-2 mm

\*\* Weight of the sensor without converter and terminal box

- weight of terminal box has to be added for remote version – 0.25 kg
- weight of converter has to be added for compact version – 0.9 kg

The sensor is designed for installation between flanges and for fastening by clamps (not included in delivery). For sensor sizes DN20..DN120, flanges with corresponding dimensions are used. **For sensor sizes DN10..DN15 the flange DN20 has to be used, because the sensor body is bigger than space between openings of corresponding flanges.**

**Protection:** compact version **IP66**, remote version **IP67** (optionally **IP68**)

**Electrodes:** **Ss** – stainless steel AISI316Ti, **Ha** - Hastelloy C22, **Ti** - Titanium, **Pt** – platinum

**Lining:** **TG** – hard rubber, **MG** – soft rubber, **NG** – resistant rubber, **PTFE** – Teflon

**Pressure:** **PN16**, PN25, PN40, PN63

**Accessories:** optional for a surcharge – grounding rings or grounding electrodes for nonconductive tube

**Flowmeter dimensions – version with aseptic screwed fitting “B” (DIN 11851)**

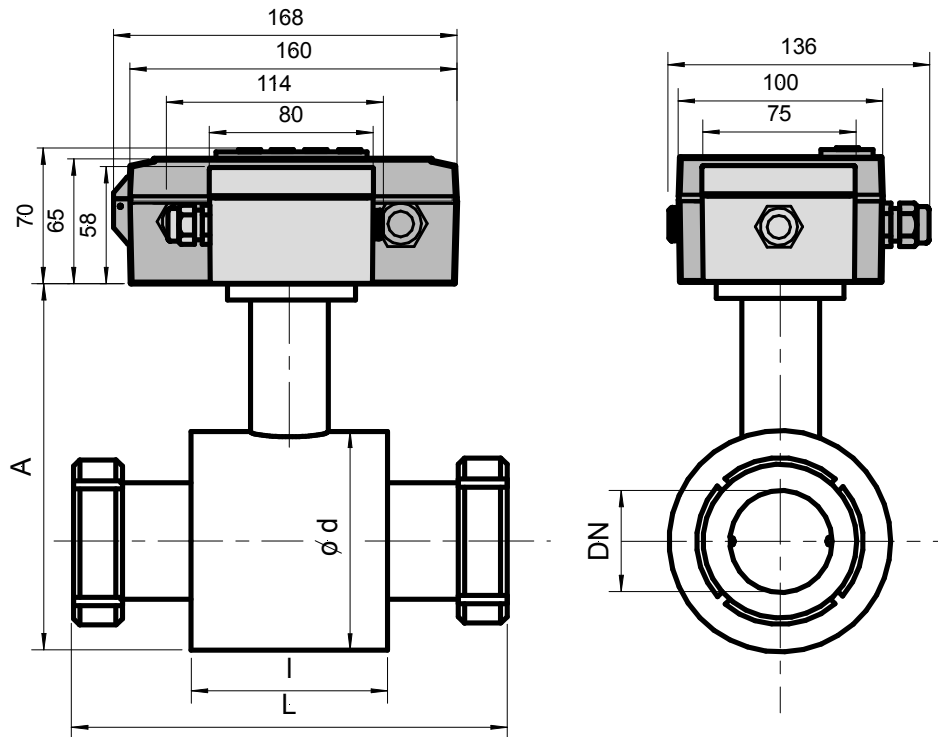

DN		d	l	A*	L*		Weight**
[mm]	[inches]				ISO 13359 EN 14154	Optional	
15	1/2	62	66	145	200	134	0.9
20	3/4	62	66	145	200	150	1.1
25	1	72	96	158	200	213	1.5
32	1 1/4	82	96	168	200	213	1.8
40	1 1/2	92	96	179	200	213	2.2
50	2	107	96	192	200	213	2.8
65	2 1/2	127	96	212	200	213	3.2
80	3	142	96	227	200	213	3.5
100	4	162	96	247	250	213	4
125	5	192	126	277	250	301	6
150	6	218	126	303	300	301	8

\* Standard construction length meets ISO 13359, different construction lengths should be indicated, e.g. "l=213"

Construction length tolerance: +0/-2 mm

\*\* Weight of the sensor without converter and terminal box

- weight of terminal box has to be added for remote version – 0.25 kg

- weight of converter has to be added for compact version – 0.9 kg

The sensor is connected to the pipeline using an aseptic screwed fitting that meets DIN 11 851 standard. Part of the fitting with cap nut is firmly fixed to the sensor. Welded counterpart with male thread and sealing are part of delivery. This sensor version is suitable for foodstuff flow. Non-conducting lining of the sensor extends over its edges to avoid both leakage and depositing of measured fluid on edges. Due to cap nuts, the sensor can be easily deinstalled and comfortably cleaned.

**Screwed fitting:** DIN 11 851

**Protection:** compact version **IP66**, remote version **IP67** (optionally **IP68**)

**Electrodes:** **Ss** – stainless steel AISI316Ti, **Ha** - Hastelloy C22, **Ti** - Titanium, **Pt** – platinum

**Lining:** **NG** – resistant rubber (for drinking water), **PTFE** – Teflon (for foodstuff)

**Pressure:** **PN16**, **PN25**, **PN40**, **PN63**

**Accessories:** optional for a surcharge – grounding electrodes for nonconductive tube



## Flowmeter dimensions – version with tube thread “G” (DIN ISO 228 )

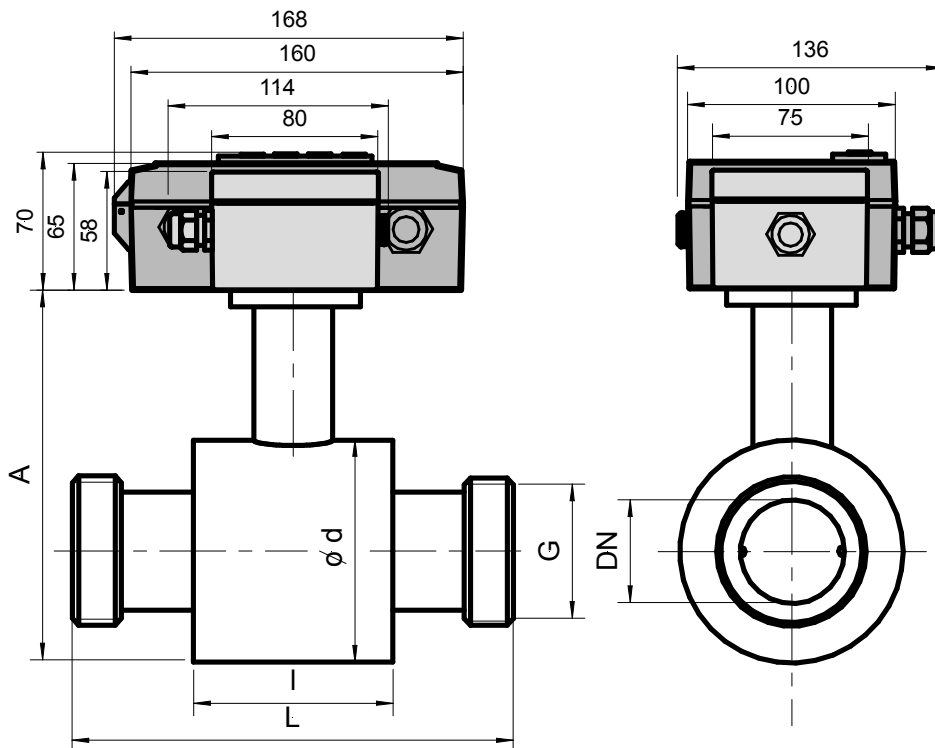

DN		G thread	d	l	A	L*		Weight** [ kg ]
[mm]	[inches]					ISO 13359 EN 14154	Optional	
15	1/2	1"	62	66	145	200	134	0.9
20	3/4	1 1/4"	62	66	145	200	150	1.1
25	1	1 1/2"	72	96	158	200	213	1.5
32	1 1/4	2"	82	96	168	200	213	1.8
40	1 1/2	2 1/2"	92	96	179	200	213	2.2
50	2	3"	107	96	192	200	213	2.8
65	2 1/2	3 1/2"	127	96	212	200	213	3.2
80	3	4"	142	96	227	200	213	3.5

\* Standard construction length meets ISO 13359, different construction lengths should be indicated, e.g. "l=213"

Construction length tolerance: +0/-2 mm

\*\* Weight of the sensor without converter and terminal box

- weight of terminal box has to be added for remote version – 0.25 kg

- weight of converter has to be added for compact version – 0.9 kg

The sensor is connected to the pipeline using a fitting with a cap nut and a gasket. Both ends of measuring tube are equipped with male tube thread. Adjacent tubes have to be equipped with fitting with cap nut (not included in delivery) and sealed using gasket (not included in delivery).

**Protection:** compact version **IP66**, remote version **IP67** (optionally **IP68**)

**Electrodes:** **Ss** – stainless steel AISI316Ti, **Ha** - Hastelloy C22, **Ti** - Titanium, **Pt** – platinum

**Lining:** **TG** – hard rubber, **MG** – soft rubber, **NG** – resistant rubber, **PTFE** – Teflon

**Pressure:** **PN16**, **PN25**, **PN40**, **PN63**

**Accessories:** optional for a surcharge – grounding electrodes for nonconductive tube

## Sensor – marking and label

PDIN	50	16	TG	Ss	Ge	Fe	Cv
							<b>Cv</b> compact version
							<b>Rvx</b> remote version (x = cable length in m)
							without full pipe check electrode
						<b>Fe</b>	optional full pipe check electrode
							without grounding electrode
					<b>Ge</b>		optional grounding electrode
				<b>Ss</b>			stainless steel electrodes
				<b>Ha</b>			Hastelloy electrodes
				<b>Ti</b>			Titanium electrodes
				<b>Pt</b>			platinum electrodes
			<b>TG</b>				hard rubber lining
			<b>MG</b>				soft rubber lining
			<b>NG</b>				resistant rubber lining
			<b>PTFE</b>				Teflon lining
		<b>6, 10, 16, 25, 40</b>					nominal pressure [bars]
		<b>150lb, 300lb</b>					nominal pressure [lb]
	<b>10..1200</b>						nominal bore diameter [mm]
	<b>3/8"..50"</b>						nominal bore diameter [inches]
<b>PDIN</b>	flanged version – flanges according to DIN						
<b>PANSI</b>	flanged version – flanges according to ANSI						
<b>B</b>	wafer version						
<b>V</b>	version with aseptic fittings for food industry						
<b>G</b>	threaded version						

Tab. Sensor marking

**Magnetic flowmeter Flomag3110**

**TCM 142/06 - 4451**

Ser.N  Year of prod.

DN  mm MAP  Bar

Q<sub>3</sub>  m<sup>3</sup>/h R  Q<sub>3</sub>/Q<sub>1</sub>

Q<sub>1</sub>  m<sup>3</sup>/h T  °C

EMC Class  Head loss

Ambient  Sens. class

M7: 4+20mA = 0+10 m3/h M4: 1kHz = 10 m3/h

Type

K1  K2

Protect  Excit.  Hz

Fig. Sensor label

## Converter – marking and label

FLOMAG	3	0	0	0	S1	F1	--	B1	B1	C1	A1	V1
												-- module not fitted
												V1 display and keypad
												-- module not fitted
												A1 active output module 0(4)..20 mA (12 bit) - replaced by A5
												A2 active output module 0(4)..20 mA (16 bit) - replaced by A5
												A3 active output module 4..20 mA (16 bit) - replaced by A6
												A4 passive output module 4..20 mA (16 bit) - replaced by A7
												A5 active output module 0(4)..20 mA (16 bit)
												A6 active output module 4..20 mA (16 bit) (HART w. mod.H1)
												A7 passive output module 4..20 mA (16 bit) (HART w. mod.H1)
												B1..B5, E1
												-- module not fitted
												A7 pasive output module 4..20 mA (16 bit)
												C1 RS232 module
												D1 RS485 module
												D2 communication loop module 0/20 mA
												D3 M-Bus
												G1 GSM
												H1 Bell 202 modem HART compatible (only with module A6 or A7)
												B1..B5, E1
												-- module not fitted
												A7, B1..B5, E1
												-- module not fitted
												A7 pasive output module 4..20 mA (16 bit)
												B1 binary output – passive optoMOS 250V(AD,DC) max.120mA max.4kHz
												B2 binary output – passive optoMOS 60V(AD,DC) max.300mA max.10kHz
												B3 binary output – active 5 VDC max.10mA max.12kHz
												B4 binary output – active 24 VDC max.40mA max.12kHz
												B5 binary output – relay 250VAC/1A
												E1 binary input - active (for nonvolatile contacts or open collector)
												-- module not fitted
												M1 memory module for data archiving
												-- module not fitted
												F1 electrochemical electrode cleaning module
												F2 Full pipe check module
												F3 module with F1+F2 functionality
												S1 sensor signal input amplifier module (allways included)
												0 Power supply 85-265 VAC
												1 Power supply 24 V (18-36 VDC, 18-26 VAC)
												2 Power supply 12 V (9-18 VDC, 9-14 VAC)
												0 Compact version
												1 Remote version
												0 Unspecified (working) meter
												1 Specified meter

Tab. Converter marking

**Converter in remote version should be always completed with sensor with the same serial number!**

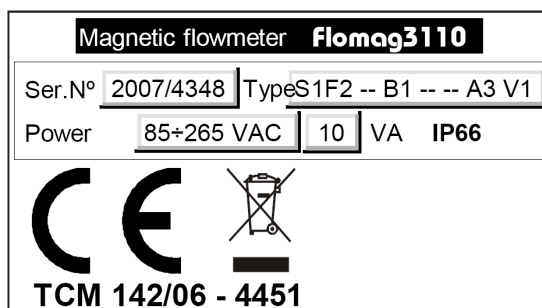

Fig. Converter label

Ranger Instrument Co Ltd  
Rutherford Road  
Basingstoke  
RG24 8PG  
Tel 01256 464911