

Tensioned Wire Trellis - Made To Measure Installation Advice

Each Tensioned Wire Trellis System consists of :

- 1 x 4mm Ø 7x7 stainless steel wire rope to your chosen length
- 1 x 4mm M8 threaded stainless steel studs fixed at each end
- 2 x Surface mounting stainless steel hubs
- 2 x Stainless steel M8 nuts
- 2 x Stainless steel M8 dome nuts
- 2 x Stainless steel M8 dual thread screws

Manufactured from 316 (marine) grade stainless steel, making this kit ideal for harsh outdoor conditions.



Preparation :

Plan your project in advance to ensure you have the correct number of mounting hubs, wires and fittings.

The system can be mounted either vertically or horizontally onto masonry and timber surfaces.

You will need a few simple household tools for a quick and easy installation: Chalk/Pen, Drill, Hex Head Key, Wrench and Spanner.

Note :

The dual thread pin allows direct installation into hardwood timber (such as oak) and if combined with the correct rawl plug it is attachable to almost any masonry surface.

Ensure you leave no more than 30mm of thread protruding from the mounting surface for a perfect fit.

Do not mount onto mortar between bricks as this method is not as strong as mounting into the brick itself.

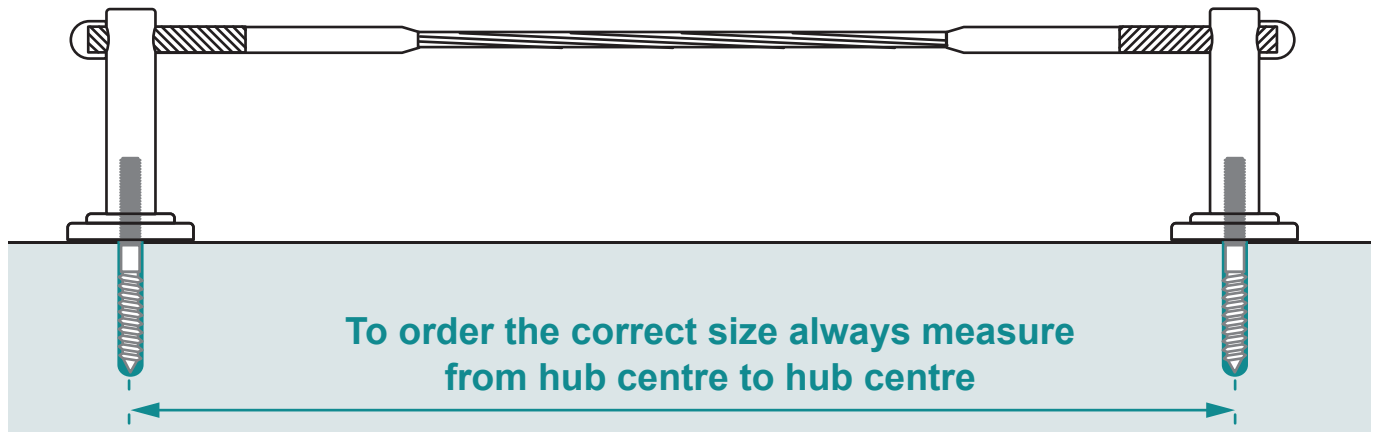

1 Getting Started

It is a good idea to layout your design onto the relevant surface with a pen or chalk prior to drilling any holes, taking factors such as brick spacing into consideration.

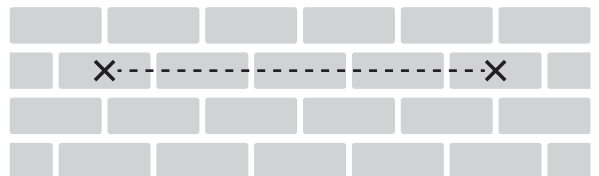

2 Drill Pilot Holes

The dual thread pin allows direct installation into hardwood timber (such as oak) or if combined with the correct rawl plug it is attachable to almost any masonry surface. We recommend a 6mm or 7mm drill piece for wood installation or a 10mm if using a 10mm plug on solid brick (not mortar) to reduce the chance of cracking)

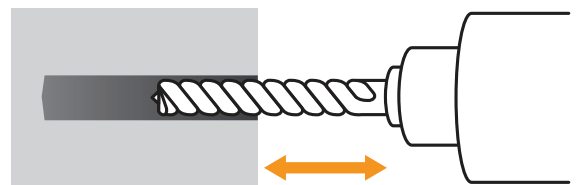

Tensioned Wire Trellis - Made To Measure Installation Advice

3 Insert Dual Thread Screw

It is important to ensure that no more than 30mm of thread is protruding from the mounting surface.

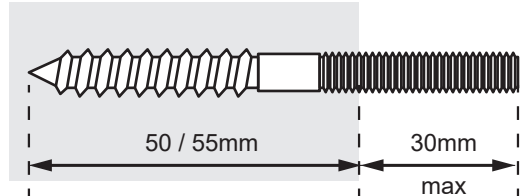

A: Timber Mount

Screw in the dual thread screw into place using a hex head key.

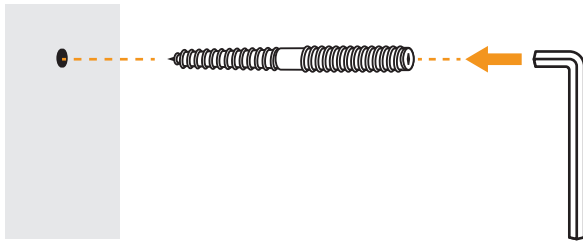

B: Masonry Mount

Insert rawl plug first and then screw in the dual thread screw into place using the hex head key.

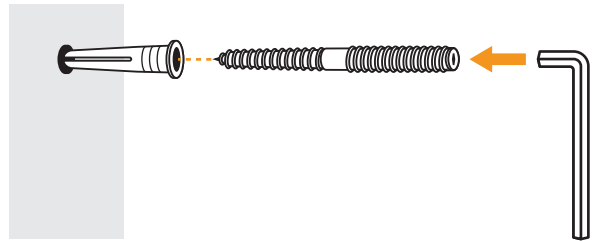

4 Attach Hubs

Screw the surface mounting hubs onto the dual thread screws, aligning the centre holes with each other.

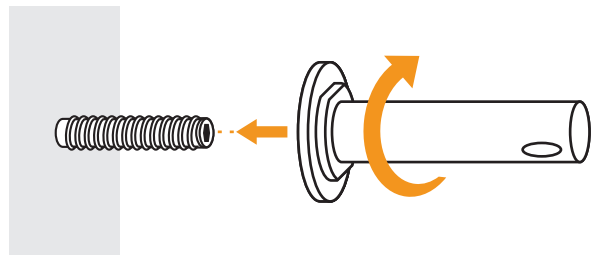

Hub Alignment

Perfect alignment of the cross holes can be achieved by simply turning the adjustable base plate of your hub in or out.

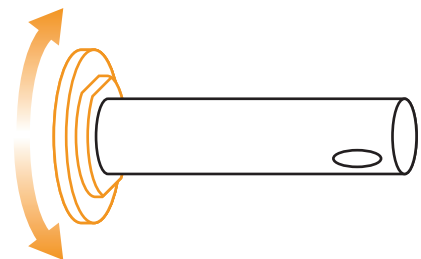

5 Attach Ready Made Wire Cable

Place the threaded end studs into position through the hub fixing holes.

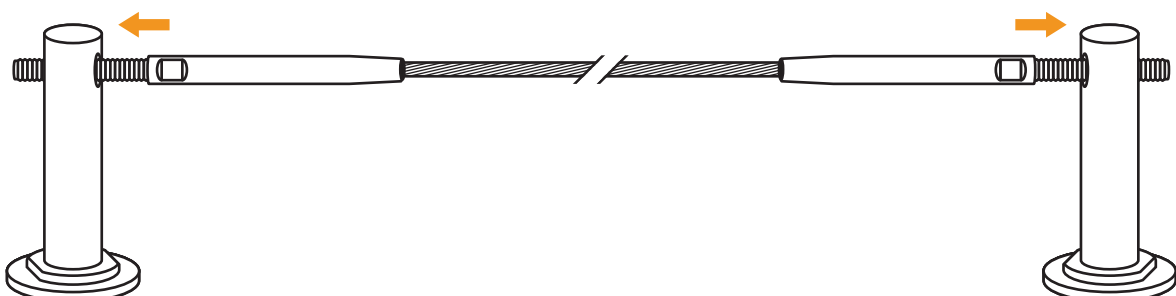

Tensioned Wire Trellis - Made To Measure Installation Advice

6 Attach M8 Nuts

Starting at one end, attach a M8 nut.

Remember to leave only a small amount of thread showing, so that when you tension the wire, more thread will be revealed to provide thread for the dome end nut.

Once in place attach the remaining M8 nut to the opposite end. Ensure both ends are finger tight with an even amount of thread showing.

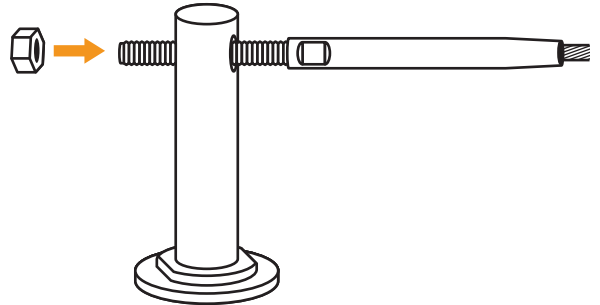

7 Applying Tension

When applying tension it is important that you do not allow the wire rope to twist. We recommend using a 6mm spanner or a set of grips on the spanner flat of the threaded end assembly to hold the wire in place.

Use a 13mm spanner to tighten the M8 nuts evenly in slight increments until you have the required tension.

Ensure you leave the same amount of thread protruding at each end.

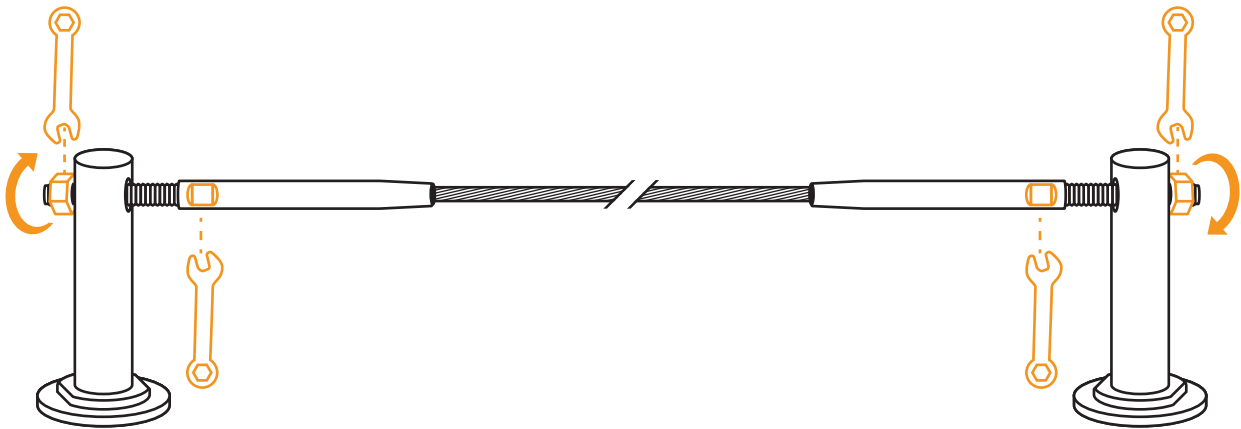

8 Attach the M8 Dome Nuts

Once you have tensioned the wire rope, simply attach and tighten a M8 dome nut against the M8 nut at each end. This will provide a safe and stylish finish to your tensioned wire trellis system.

