



Packaging & Materials Testing

*Heat Sealability, Seal Strength & Hot Tack
Heat Sealers for the Lab, Pilot Plant & Production
Physical Strength & Material Properties
Permeation of Barrier Materials
Package Integrity
Surface & Optical Properties
Sample Preparation
Laboratory Equipment
Contract Testing Services
After-Sales Support*



***ASSURED QUALITY
TESTING SOLUTIONS***



About us

RDM Test Equipment is a British manufacturer and distributor of quality testing solutions that have become 'industry standard' in Packaging & Materials Testing. With over 30 years experience, our passion is to help solve your material or package challenges. We don't just manufacture and sell testing products, from our in-house laboratory, we also provide testing consultancy and contract testing services.



David Murrell, Managing Director



Phil Neal, Sales Director



Mike James, Technical Director

The company was formed in 1985 by brother in-laws David Murrell and Mike James, both graduate Mechanical & Electrical Engineers from Middlesex and Essex Universities respectively. Their vision to help material and packaging technologists develop and control materials is as relevant today as it was then.

Initially focusing on measuring heat seal characteristics, the company now provide a range of over 100 testing instruments for packaging, polymers, pulp, paper, board, textiles, rubber, and foam; used in many industries including food & beverage, medical devices & pharmaceuticals, inks, printing & coating, electronic, industrial and educational establishments.

The RDM brand of Test Equipment is manufactured in the UK, backed by customer service, technical support and on-site maintenance & calibration services all based from the Hertfordshire head office, operating under ISO9001 accreditation.

RDM products are available globally, either directly from our UK and USA offices or from our worldwide partners.

Our Partners & Brands



RDM Test Equipment manufacture flexible packaging test equipment focused on heat sealing, hot tack, seal strength and friction.



Mocon is the world leader in permeation measurement instruments for testing the barrier properties of flexible packaging materials.



TMI manufactures physical property testing instruments for the packaging, paper, pulp, plastic film, foil, ink, coatings, non-woven, textile, adhesive and corrugated industries.



Messmer Buchel is a specialist manufacturer and supplier of quality control equipment designed to meet the needs of the pulp, paper and corrugated industries.



Cerulean manufacture the Laboratory Carton Tester, based on the original Newton Carton Tester, the only instrument to test a complete carton.



Tobias Associates Inc is a manufacturer of innovative graphic arts equipment. In addition to the printing industry, Tobias also serves the photographic, micrographic, radiograph, pulp and paper and electronic publishing industries.



Adam Equipment is an ISO 9001:2000 certified global organisation with more than 30 years experience in the production and sale of electronic balances & scales.



Korutest manufactures the Chalmers DST, which is considered to be the most superior corrugated board testing instrument.

UK & International:
T: +44 1279 817171
E: sales@rdmtest.com

Americas:
T: +1 651 766 2565
E: sales@rdmtest.com



**ASSURED QUALITY
TESTING SOLUTIONS**

www.rdmtest.com

International Testing Standards

Heat Sealability

ASTM F2029	Standard Practices for Making Heatseals for Determination of Heatsealability of Flexible Webs as Measured by Seal Strength.
------------	---

Medical Pack Heat Sealing

ISO 11607-2	Packaging for Terminally Sterilized Medical Devices Part 2: Validation Requirements for Forming, Sealing and Assembly Processes
-------------	---

Friction Testing

ASTM D1894	Standard Test Method for Static and Kinetic Coefficients of Friction of Plastic Film and Sheeting
ISO 8295	Plastics - Film and Sheeting - Determination of the Coefficients of Friction
ISO 15359	Paper and Board - Determination of the Static and Kinetic Coefficients of Friction - Horizontal Plane Method
TAPPI T549	Coefficients of Static and Kinetic Friction of Uncoated Writing and Printing Paper by use of the Horizontal Plane Method
ASTM D2534	Standard Test Method for Coefficient of Kinetic Friction for Wax Coatings

Haze

ASTM D1003	Standard Test Method for Haze and Luminous Transmittance of Transparent Plastic
------------	---

Gelbo

ASTM F392	Standard Practice for Conditioning Flexible Barrier Materials for Flex Durability
-----------	---

Seal Strength / Tensile / Tear

ASTM F88 / F88M	Standard Test Method for Seal Strength of Flexible Barrier Materials
FINAT 1, 2, 3, 9	FINAT Test Methods for Self-adhesive Laminates and Labels
ASTM D3330 / D3330M	Standard Test Method for Peel Adhesion of Pressure-Sensitive Tape
ASTM D6252 / D6252M	Standard Test Method for Peel Adhesion of Pressure-Sensitive Label Stocks at a 90° Angle
ISO 8510-2	Adhesives - Peel Test for a Flexible-bonded-to-rigid Test Specimen Assembly - Part 2: 180 Degree Peel
BS EN 1939	Self Adhesive Tapes. Determination of Peel Adhesion Properties.
BS EN 1895	Adhesives for Paper and Board, Packaging and Disposable Sanitary Products. 180°. "T" Peel Test for a Flexible-to-flexible Assembly
BS EN 868-5	Packaging for Terminally Sterilized Medical Devices. Sealable Pouches and Reels of Porous and Plastic Film Construction. Requirements and Test Methods
ASTM D1938-14	Standard Test Method for Tear-Propagation Resistance (Trouser Tear) of Plastic Film and Thin Sheeting by a Single-Tear Method
ASTM D1004-13	Standard Test Method for Tear Resistance (Graves Tear) of Plastic Film and Sheeting
ISO 6383-1	Plastics - Film and Sheeting - Determination of Tear resistance -Part 1: Trouser Tear Method
ISO 12625	Tissue Paper and Tissue Products

Hot Tack

ASTM F1921 / F1921M	Standard Test Methods for Hot Seal Strength (Hot Tack) of Thermoplastic Polymers and Blends Comprising the Sealing Surfaces of Flexible Webs
DIN 55571	Hot Tack—Part 1: Position Measuring Devices Hot Tack—Part 2: Peel Strength Measuring Devices

Heat Sealability, Seal

Heat Seal parameters are easily measured; **Heat Sealability = Temperature + Pressure + Time**. Yet maintaining optimum heat sealing conditions in production and recognising the true cause of poor sealing remains a challenge. Measurement of heat sealing parameters is done by creating 'controlled seals' on a calibrated **Laboratory Heat Sealer** according to ASTM F2029, then peeling the seal apart with a **Seal Strength Tester** at a controlled rate to measure either Ultimate Seal Strength (after cooling, method ASTM F88) or Hot Tack Strength (peel tested within 150ms of the seal being formed, method ASTM F1921). By varying the sealing temperature and dwell time, the optimum sealing conditions can be found.

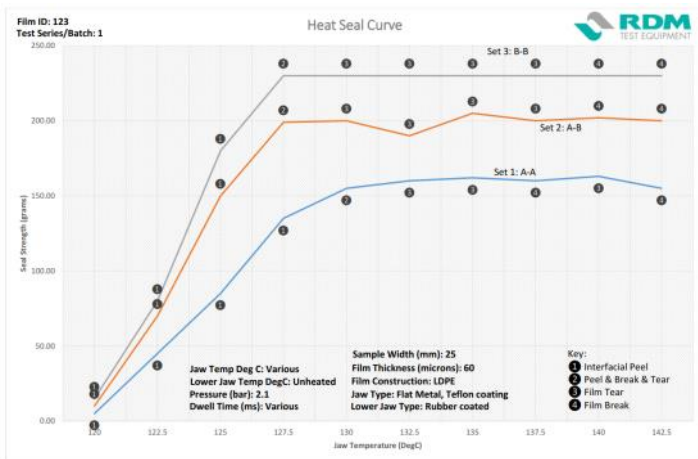

HS-2 Lab Heat Sealer

Heat Sealability

An evaluation of the sealing parameters of heat sealable materials.

Controllable temperature + Pressure + Time

ASTM F2029

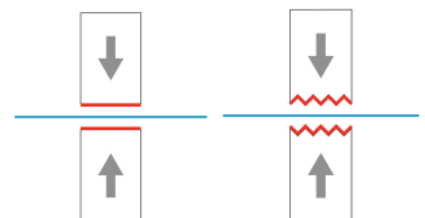

HSG-3/5 Gradient Heat Sealer

Heat Sealability Gradient

Rapidly establishes heat sealing parameters across a range of temperatures simultaneously.

ASTM F2029

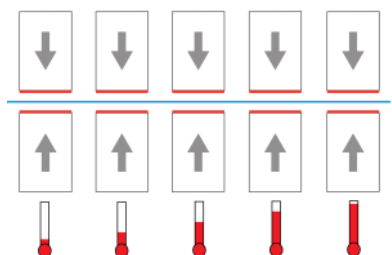

Temperature Gradient

Product packagers who regularly test heat seal parameters of incoming film as part of a well-managed quality system, will transfer the measured parameters to the heat sealing process in production to optimise the sealing conditions. Variations in sealing parameters will be found from film supplier to supplier, roll to roll, and even within a roll. The introduction of new materials with functional and barrier layers has narrowed the tolerances for optimum sealing. Even small variations in sealing parameters can impact the quality of resulting seals, with typical poor quality shown as weak seals, channel leaks, edge leaks, back seal/end seal junction leaks, hardened brittle areas caused by overheating, unsealed areas caused by under-heating.

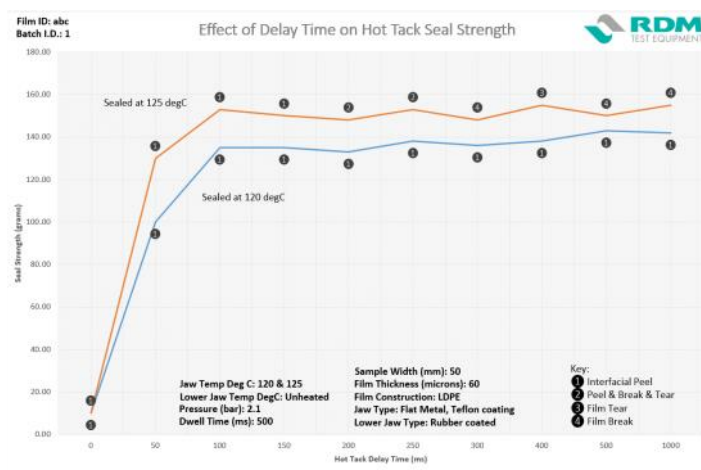

SST-3XS Seal Strength Tester

Seal Strength

The peak force, average force and minimum force to peel open a seal.

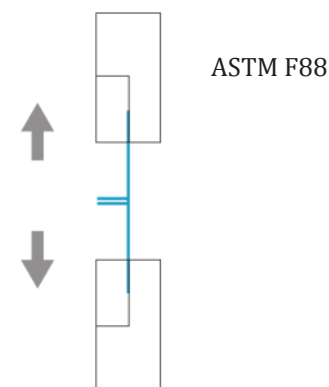

HT-1XS Hot Tack Tester

Hot Tack Strength

A measurement of film heat sealability and instantaneous hot seal strength, defined as hot tack.

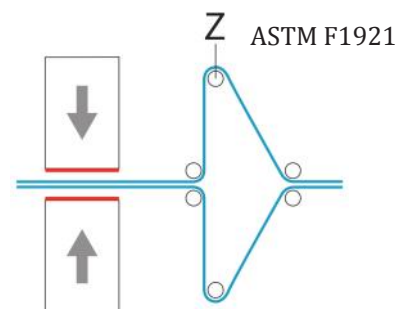

Heat Sealers for the Lab,

RDM Heat Sealers help you to achieve better sealing quality. With a range of basic sealers through to touchscreen controlled semi-automated production sealers, and custom made designs to meet your special requirements, we provide our experience and expertise to help optimise your heat sealing.

Suitable for all sizes of flexible pouches, lidded trays and pots, optionally with gas flush and/or vacuum. RDM Heat Sealers provide the flexibility and control to suit a wide range of needs in the lab, pilot plant or for small volume manual production.

All models are available with Single or Dual heated sealing jaws, optionally with permanent Teflon coating for added durability.



HSE-3 Heat Sealer

Long Bar Heat Sealing

Heat sealing of heat sealable materials such as film, foil, laminates and paper.

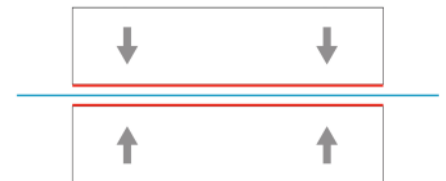

HSB-1 Heat Sealer

Long Bar Heat Sealing

Heat sealing of heat sealable materials such as film, foil, laminates and paper.

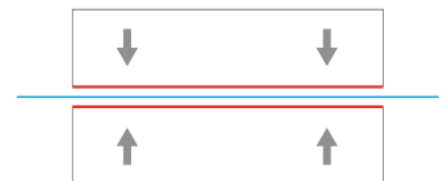

**HSP-1 & HSP-2
Tray/Pot Heat Sealers**

Custom Tray Sealers

Production machines for low volume manual sealing of trays, pots, bottles etc.

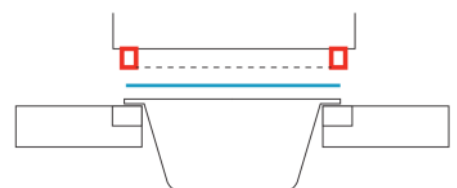



HSX Series Medical Heat Sealer



Medical Pouch Sealing

Production of high quality heat seals in Tyvek, Film, Foil, & Paper used for sterile barrier medical packaging.

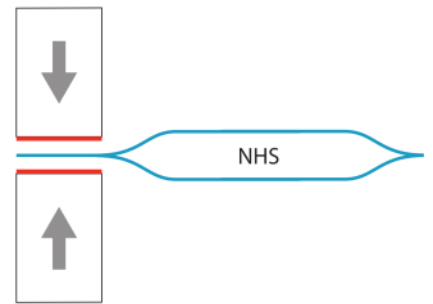

HS-650 Heat Sealer

Large Pouch Sealing

Production of heat seals in large packs up to 650mm.

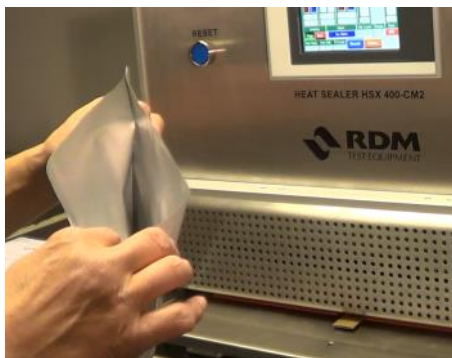
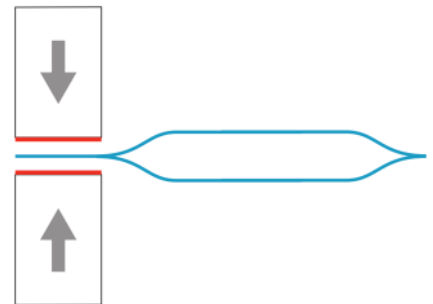

Gas Flush/Vacuum Heat Sealer

Gas Flush/Vacuum Heat Sealers

Production machines for heat sealing of gas flushed and/or vacuum packs.

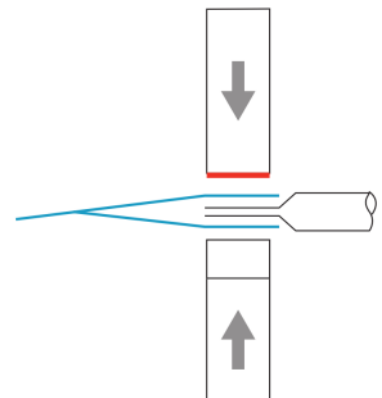

Physical Strength and



Materials possess a wide range of quantitative properties, such as physical strength, or thickness. In many applications, specific properties will be critical to the performance of the material for their intended use. Testing equipment is used to simulate conditions and measure the materials response. This helps in material selection thereby aiding in material selection.

Properties can vary according to the way in which they are measured e.g. materials. Testing equipment has been developed to help achieve standardisation.

RDM Test Equipment can help you to select the most appropriate testing equipment for your application.

Gelbo Flex Durability

ASTM F392



GF-392 Gelbo Flex Tester

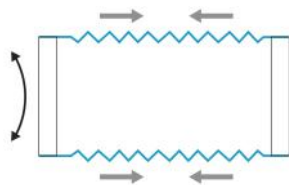

Evaluation of flex durability of films/laminates to repetitive strain.

Burst Strength

ISO, ASTM, TAPPI



Burst Tester

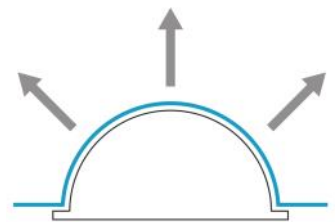

Measurement of 3D burst strength of flat materials eg. Plastic film, paper, board, textiles and non-wovens.

Carton Crease and Board Stiffness

BS 6965



LCT Carton Tester

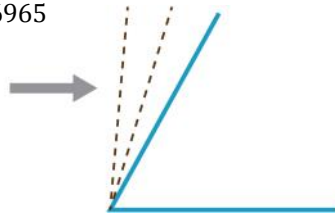

Measurement of crease & board stiffness, opening force, and spring back.

Tear Resistance

TAPPI T414, ASTM D1922, ISO 1974



Elmendorf Tear Tester

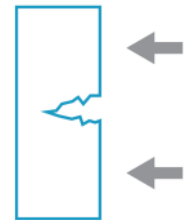

Measurement of tear resistance of flat materials, eg films, paper, textiles, non-wovens.

Cobb / Absorption

Manual Cobb Tester



Automatic Cobb Tester



Absorption characteristics of a range of coated and uncoated materials.

Melt Flow Index

ISO 1133, ASTM D1238, BS 2782



Melt Flow Indexer

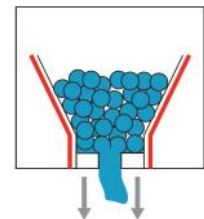

Measurement of the flow properties of molten polymers.

and Material Properties

ness. These may be a constant or a function of another property e.g. temperature. In most e intended purpose, measurement and control of these properties is therefore crucial. operties may be used to compare the benefits of one material or supplier versus another, on and ongoing quality control.

ial direction, and therefore many internationally recognised testing standards n, commonly ASTM, ISO, FINAT, BS, DIN, JIS, TAPPI.

ate tests to define your materials and control your processes.

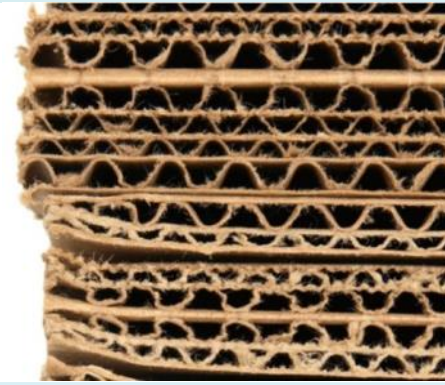

Falling Dart Impact

ASTM D1709, ISO 7765

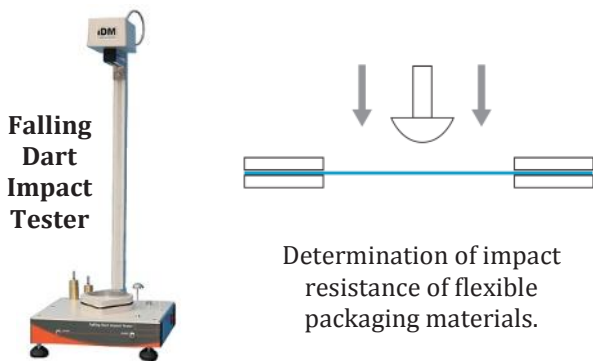

Determination of impact resistance of flexible packaging materials.

Thickness / Gauge / Grammage / Caliper

ASTM, ISO, TAPPI



Digital Micrometer

Thickness with precise contact pressure and anvil dimensions to International Standards.

Tensile, Compression, Bending Strength

ASTM D882, ISO 527



Tensile Tester

The strength, elasticity, stress, strain and modulus of packaging materials.

Release & Adhesion Strength

Release & Adhesion Tester



Measurement of peel strength of adhesive labels, release papers and various packaging materials.

Puncture Resistance

ASTM F1306



Puncture Test Jig

Slow rate penetration of flexible barrier films, laminates, paper, board and non-wovens

Crush Strength

TAPPI, ISO, DIN, PPITA, FEFCO, SCAN



Crush Tester

Crush strength, including RCT, ECT, PAT, CCT and a wide variety of board, tubes, paper and plastics

Permeation of Barrier Materials



Mocon is recognised as the global leader of quality permeation testing systems, which are fully supported in the UK and Ireland by RDM Test Equipment.



Ox-Tran 2/22

Permeation Measurement for: Oxygen (OTR) Water Vapour (WVTR/MVTR) Carbon Dioxide (COTR)

- **OTR:** ASTM D3985, F1927, F1307, F2622, ISO 15105-2, DIN 53380.
0.0005 to 144,000 cc/m²/day.
- **WVTR:** ASTM F1249, E398, D6701, ISO 15106-2 & -3, TAPPI T557.
0.00005 to 100,000 gm/m²/day.
- **CO²TR:** ASTM F2476, DIN53380-4.
1 to 1,550,000 cc/m²/day.
- Flat film or package testing.
- Contract Testing Services.

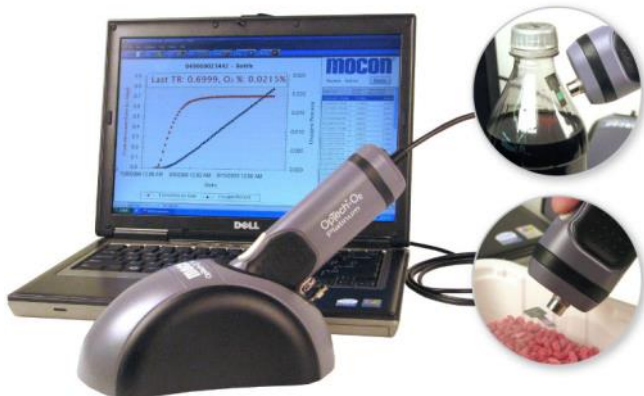

OpTech O2 Platinum

Oxygen Headspace Analyser

- Optical Fluorescence, does not consume headspace gas. ASTM F2714, F3136.
- 0.015% to 25% O₂ concentration.
- Non-destructive shelf life studies.
- Permeation, headspace, dissolved O₂, package leak.

Heat sealed packs are susceptible to leaks through pinholes, channel leaks or unsealed areas caused by product contamination, especially in powdery, seasoned, or flaky products. Where seal integrity is vital to maintain product shelf life or sterility, quality control leak & burst testing provides instant feedback and traceability. Systematic production issues can be quickly discovered and resolved with confidence.

Tests are commonly destructive and conducted off-line. Non-destructive and in-line methods are sometimes possible, depending on the pack format. RDM provide systems for leak & burst tests with positive pressure decay, flow measurement, vacuum decay, and water bath bubble methods.

ASTM F2054, F2095, F2096, F1140, DIN55508-1, ISO11607

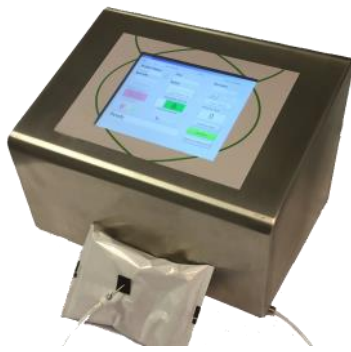

Check-A-Pack 200

Gas Analysis, Leak & Burst Package Tester

- Measurement of O_2 / CO_2 , leak hole size, and burst strength, air flow method.
- Full data storage, network connectivity via Ethernet, USB.
- Auto or manual sample preparation.

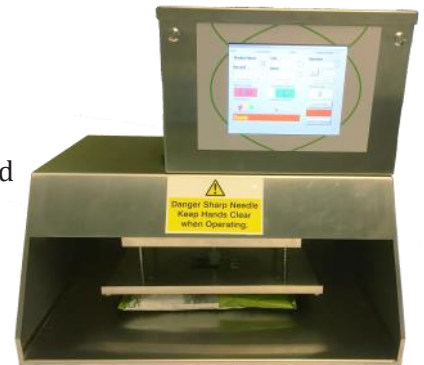

Check-A-Pack 600

Bubble Leak Tester

- Uses a regulated pressure from 100 to 850 mbar to test integrity of sealed packs
- Burst testing to determine seal strength
- Simple & fast for quality control



BLT Bubble Leak Tester



Lippke 5000

Leak, Creep and Burst Package Tester

- Measurement of leak, creep and burst strength, pressure decay method.
- Stand alone or pc controlled.
- Restraining plates, open pouch clamp and accessories.





Flat sheet materials require a range of surface and optical tests, measuring their performance or interaction with other materials, such as the friction of a thin film over a metal former, or the haze through a transparent film used in point of sale packaging.

Coefficient of Friction

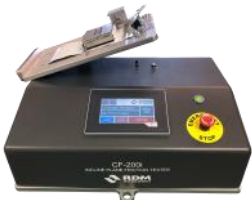

CF-200i Inclined Plane Friction Tester



CF-800XS Friction Tester

- Measurement of Static & Dynamic Co-efficient of Friction (COF/SLIP).
- 'Gold Standard' test method, highly repeatable and reproducible.
- ASTM D1894, ISO 8295, BS 2782, TAPPI T549 or
- ASTM D4918, G219, TAPPI T815, T548, NFQ03083

Haze & Transmittance

- Measurement of Haze & Transmittance of flat sheet materials.
- Fully automatic test method.
- ASTM D1003, JIS K7105, JIS K 7136, JIS K 7361, ISO 13468, ISO 14782.

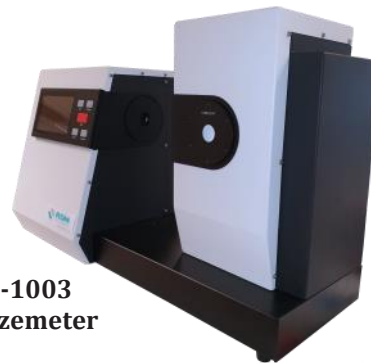

HT-1003 Hazemeter



TH-1003-M Hazemeter

Gloss / Opacity / Shade



Novo Glossmeter

- Handheld instruments for Gloss, Opacity and Shade of flat sheet materials.
- Touchscreen, lightweight and easy to use.
- Connectivity for data transfer to PC.

Contact Angle

- Measurement of Static & Dynamic Contact Angle, wetting, sorption, and spreading.
- Video based, fully automatic test method.
- Checks surface for contamination, adhesion and printability.



Pocket Goniometer PGX+

Ink Rub / Transfer



Digital Ink Rub Tester

- Scuffing / Rubbing resistance of printed materials.
- 2 lbs and 4 lbs weights, optionally heated.
- ASTM D5264, F1571, F2497, TAPPI T830, FINAT FTM27.

Printability

- Measurement of paper surface roughness in simulated printing conditions.
- Single or Dual Head options.
- ISO 8791/4, TAPPI T555.

Parker Print-Surf



Surface Roughness



Bendtsen Roughness Tester

- Measurement of paper and board surface roughness and air permeance to Bendtsen method.
- Repeatable, easy to use method.
- ISO 5636/8791/2, BS4420, DIN 53108 / 53120, SCAN P21.

Sample Preparation

Strip Cutters

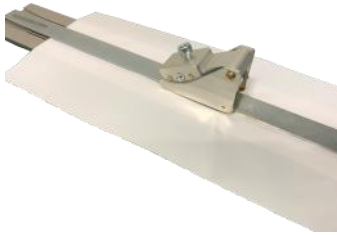

GSC-1 Guided Strip Cutter

- Suitable for thin flexible materials, e.g. films, paper
- Various sizes available

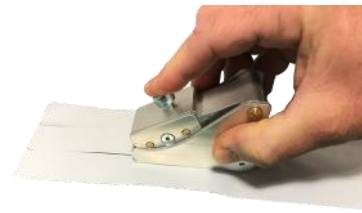

FSC-1 Freehand Strip Cutter

Twin Blade Cutters



Twin Blade Cutter

- Precision hardened steel blades
- Various sizes
- High accuracy samples

Templates

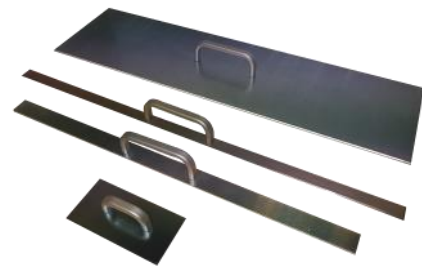

- Various sizes available

Laboratory Equipment

Handheld Micrometers



DML3034



DML3032

- Cost effective solution for basic measurements
- Suitable for non-compressive materials

Analytical Balances

- Wide range of analytical, precision, density determination and moisture balances.
- Reliable, cost effective solution.



PGW Balance

Laboratory Ovens

- Drying Ovens, Thermostatic Chambers, & Cooled Incubators
- -20degC to +300degC
- 15 to 750 litre capacities



NE8-32S

- RDM Test Equipment independently source products from around the world to provide a 'one-stop shop' for flexible packaging laboratories in the UK & Ireland.
- All products include manufacturer warranty, backed with RDM technical support.

Our Packaging Testing Lab is equipped with many of the products needed for flexible film testing, including brands such as RDM, MOCON, TMI, Messmer Buchel, Ametek, Cerulean, and Adam.

Sub-contracting your testing provides flexibility, and a cost effective solution for your specific project or for on-going quality control.

LAB FACILITIES INCLUDE:

- Laboratory Heat Sealing, Seal Strength Testing and Hot Tack Testing for heat sealability studies of barrier materials.
- Package Integrity (Leak, Creep & Burst) testing for finished packs, such as food and medical device pouches.
- Mocon Permeation of films and packages, Oxygen, Water Vapour or Carbon Dioxide.
- Friction Testers for measuring slip of flat materials such as packaging films.
- Medical Heat Sealers for sealing sterile barrier packs in cleanroom environments.
- Gelbo Flex for flex resistance of films, and laminates.
- Universal Tester for tensile testing, crush tests, insert/extraction tests, bending resistance.
- Precision micrometers, balances and laboratory ovens.

After-Sales Support

Our customers demand the highest levels of support and after sales service, therefore our objective is to provide a no compromise back up for the life of the instruments we supply.

RDM engineers provide: Installation & Commissioning Services, On-Site User Training, On-Site Breakdown Repair Services, and Annual Service & Calibration.

ON SITE SERVICE AND CALIBRATION

Our engineer comes to your site to carry out a comprehensive calibration service. This allows for short down times as the equipment will only be out of service during the engineers visit. In this time it will be serviced, calibrated and issued with a traceable UKAS certificate.

IN HOUSE SERVICE AND CALIBRATION

This is in our facility in Hertfordshire, UK. Your equipment will be serviced and calibrated at a fraction of the cost.



International



RDM products are available globally, either directly from our offices in UK and USA, or from our international partners.

Refer to www.rdmtest.com for your nearest distributor.

UK & International:

RDM Test Equipment Ltd
Unit 39 Golds Nurseries Business Park
Jenkins Drive, ELSENHAM
Hertfordshire, CM22 6JX
United Kingdom

T: +44 1279 817171
E: sales@rdmtest.com

Americas:

RDM Test Equipment LLC
441 Old Hwy 8 NW
Suite 200/201, New Brighton
Minneapolis, MN 55112, USA

T: +1 651 766 2565
M: +1 651 485 2372
E: sales@rdmtest.com