



F

EVAPORATIVE COOLING



Specialist Distributor:
Adremit Limited, 5A Commercial
Courtyard Settle, North Yorkshire.
BD24 9RH. Tel. 01729 824108
www.puravent.co.uk info@adremit.co.uk

Get In Touch

 Call: [0845 6880112](tel:08456880112)
 Email: info@adremit.co.uk

Our Address

Puravent, Adremit Limited, Unit 5a, Commercial Yard,
Settle, North Yorkshire, BD24 9RH





Designed and built by
MET MANN

5-year guarantee
exterior structure except panels
1-year guarantee
all other components

RENOVATION PLAN
Ask about special terms

AD BIG PREMIUM

ECOLOGICAL EVAPORATIVE COOLERS. 28,000 TO 63,000 M³/H

MET MANN has developed the new AD Big Premium line of evaporative coolers with flow levels of 28,000; 32,000; 38,000; 54,000 and 63,000 m³/h.

This line of products is produced with a variety of air discharge positions (top, bottom or side). Their elevated levels of cooling, as well as reduced consumption of electricity, make them an economical and completely ecological air treatment system, since the refrigerant element is water. The powerful and silent air fan and water pump also consume low levels of energy, producing a high level of energy efficiency compared to other cooling systems. Our equipment is ideal for air treatment applications in commercial, industrial or agricultural locations.

Designed and built by

The design and manufacturing has been performed by MET MANN in an integrated manner, taking into account the need for systems with high levels of performance, ease of installation and guaranteed efficiency and durability over time.

Some of the manufacturing details include:

- Rigid structural frame with AISI-316 stainless steel water tray.
- Corner posts made from AISI-304 stainless steel.
- High-efficiency cooling panels with RAL 7035 gray protective grills.
- Fan with RAL 7035 gray anti-corrosion treatment.
- Protective covering for bearings to prevent oxidation.
- Solid base with built-in feet to facilitate installation and transport.
- Automatic drainage system patented by MET MANN.
- Continuous drainage to avoid concentrated levels of mineral salts.
- Panels open easily with a half turn of the rotating knobs.
- Factory-installed hydraulic and electrical connections.
- Optional stainless steel panels and upper cover (Inox version).
- Upon request, dust filtration system and ATEX fan and motor can be provided.

WHY MET MANN?

- 5-YEAR GUARANTEE FOR THE EXTERIOR STRUCTURE AND 1-YEAR FOR PANELS AND OTHER COMPONENTS.
- WE ARE MANUFACTURERS AND CAN ADAPT PRODUCTS TO YOUR NEEDS.
- FULLY PERSONALIZED TECHNICAL AND COMMERCIAL CONSULTATION.
- WE GUARANTEE THE SUPPLY OF REPLACEMENT PARTS FOR AN UNLIMITED TIME.



QUICK-OPENING APERTURES WITH HALF-TURN KNOB.



WATER DISTRIBUTION SYSTEM IN THE UPPER COVER.



BEARINGS WITH CORROTEC ANTI-CORROSION TREATMENT AND PROTECTIVE COVER.



AUTOMATIC DRAINAGE VALVE SYSTEM PATENTED BY MET MANN NO. 200601656.



GRUNDFOS WATER PUMP WITH FLOW REGULATION AND CONTINUOUS DRAINAGE SYSTEM TO AVOID MINERAL SALT CONCENTRATION.

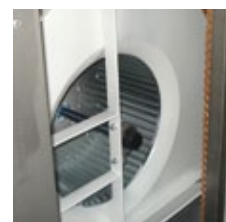

FAN GROUP WITH ANTI-CORROSION TREATMENT WITH SPECIAL PRIMER AND RAL 7035 GRAY COLOUR.



LOWER BASE FOR EASE OF TRANSPORT AND INSTALLATION.

Get In Touch

Call: 0845 6880112
Email: info@adremit.co.uk

Our Address

Puravent, Adremit Limited, Unit 5a, Commercial Yard, Settle, North Yorkshire, BD24 9RH



V MODELS WITH BOTTOM AIR DISCHARGE



CODE	MODEL	AIR FLOW m³/h	PRESSURE Pa	COOLING PANEL THICKNESS mm	COOLING PANEL EFFICIENCY %	FAN POWER kW	PUMP POWER W	VOLTAGE FAN/PUMP
STANDARD								
150103021	AD-30-V	28.000	78	50	68	3,00	250	B/A
150103521	AD-35-V	32.000	39	75	81	4,00	250	B/A
150104021	AD-40-V	38.000	38	100	87	7,50	250	B/A
150105523	AD-55-V	54.000	118	75	80	9,20	380	B/A
150107022H	AD-70-V	63.000	157	100	73	18,00	380	B/A
STAINLESS STEEL								
1501030211	AD-30-V Inox	28.000	78	50	68	3,00	250	B/A
1501035211	AD-35-V Inox	32.000	39	75	81	4,00	250	B/A
1501040211	AD-40-V Inox	38.000	38	100	85	7,50	250	B/A
1501055231	AD-55-V Inox	54.000	118	75	80	9,20	380	B/A
150107022HI	AD-70-V Inox	63.000	157	100	73	18,00	380	B/A

DIMENSIONS

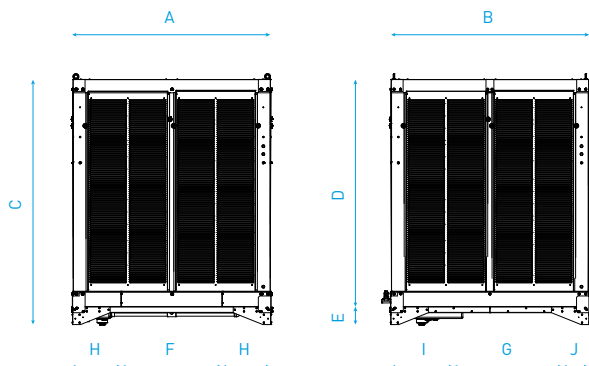

DIMENSIONS mm

MODEL	A	B	C	D	E	F	G	H	I	J	EMPTY WGT.	WGT. W/WATER
AD-30-V	1500	1500	1860	1724	136	770	795	365	505	200	355	438
AD-35-V	1500	1500	1860	1724	136	770	795	365	505	200	360	443
AD-40-V	1500	1500	1860	1724	136	770	795	365	505	200	400	483
AD-55-V	2185	2185	2084	1724	360	890	935	647	830	420	515	710
AD-70-V	2185	2185	2360	2000	360	890	935	647	830	420	655	850

Get In Touch

Call: 0845 6880112
 Email: info@adremit.co.uk

Our Address

Puravent, Adremit Limited, Unit 5a, Commercial Yard,
 Settle, North Yorkshire, BD24 9RH





VS MODELS WITH TOP AIR DISCHARGE

CODE	MODEL	AIR FLOW m ³ /h	PRESSURE Pa	COOLING PANEL THICKNESS mm	COOLING PANEL EFFICIENCY %	FAN POWER kW	PUMP POWER W	VOLTAGE FAN/PUMP
STANDARD								
150103031	AD-30-VS	28.000	78	50	68	3,00	380	B/A
150103531	AD-35-VS	32.000	39	75	81	4,00	380	B/A
150104031	AD-40-VS	38.000	38	100	87	7,50	380	B/A
150105533	AD-55-VS	54.000	118	75	80	9,20	380	B/A
150107032H	AD-70-VS	63.000	157	100	73	18,00	380	B/A
STAINLESS STEEL								
150103031I	AD-30-VS Inox	28.000	78	50	68	3,00	380	B/A
150103531I	AD-35-VS Inox	32.000	39	75	81	4,00	380	B/A
150104031I	AD-40-VS Inox	38.000	38	100	87	7,50	380	B/A
150105533I	AD-55-VS Inox	54.000	118	75	80	9,20	380	B/A
150107032HI	AD-70-VS Inox	63.000	157	100	73	18,00	380	B/A

DIMENSIONS

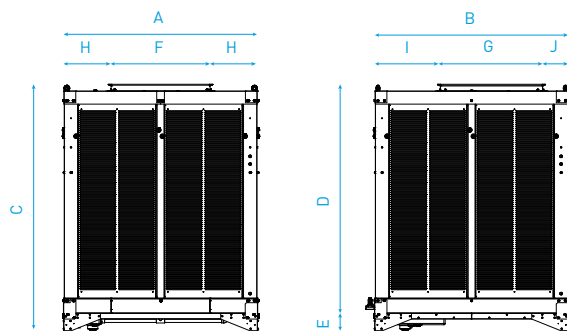

DIMENSIONS mm

MODEL	A	B	C	D	E	F	G	H	I	J	EMPTY WGT.	WGT. W/WATER
AD-30-VS	1500	1500	1910	1775	136	770	795	365	505	200	370	453
AD-35-VS	1500	1500	1910	1775	136	770	795	365	505	200	375	458
AD-40-VS	1500	1500	1910	1775	136	770	795	365	505	200	415	498
AD-55-VS	2185	2185	2150	1790	360	890	935	647	830	420	525	720
AD-70-VS	2185	2185	2430	2070	360	890	935	647	830	420	680	875

TENSIÓN: A-230V/II/50HZ B-400V/III/50HZ

Get In Touch

Call: 0845 6880112
Email: info@adremit.co.uk

Our Address

Puravent, Adremit Limited, Unit 5a, Commercial Yard,
Settle, North Yorkshire, BD24 9RH



CE

H MODELS WITH SIDE AIR DISCHARGE



CODE	MODEL	AIR FLOW m³/h	PRESSURE Pa	COOLING PANEL THICKNESS mm	COOLING PANEL EFFICIENCY %	FAN POWER kW	PUMP POWER W	VOLTAGE FAN/PUMP
STANDARD								
150103011	AD-30-H	28.000	78	50	65	3,00	250	B/A
150103511	AD-35-H	32.000	39	75	78	4,00	250	B/A
150104011	AD-40-H	38.000	38	100	85	7,50	250	B/A
150105513	AD-55-H	54.000	118	75	77	9,20	380	B/A
150107012H	AD-70-H	63.000	157	100	71	18,00	380	B/A
STAINLESS STEEL								
150103011I	AD-30-H Inox	28.000	78	50	65	3,00	250	B/A
150103511I	AD-35-H Inox	32.000	39	75	78	4,00	250	B/A
150104011I	AD-40-H Inox	38.000	38	100	85	7,50	250	B/A
150105513I	AD-55-H Inox	54.000	118	75	77	9,20	380	B/A
150107012HI	AD-70-H Inox	63.000	157	100	71	18,00	380	B/A

DIMENSIONS

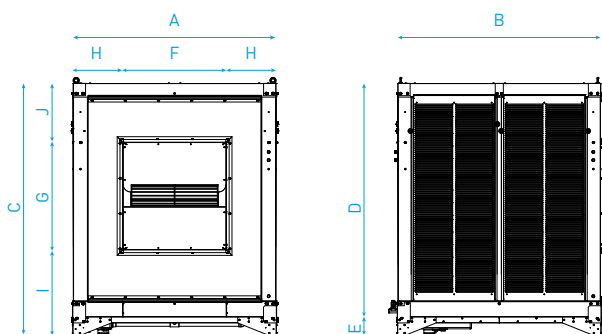

DIMENSIONS mm

MODEL	A	B	C	D	E	F	G	H	I	J	EMPTY WGT.	WGT. W/WATER
AD-30-H	1500	1545	1860	1724	136	770	795	365	630	435	355	436
AD-35-H	1500	1545	1860	1724	136	770	795	365	630	435	360	443
AD-40-H	1500	1545	1860	1724	136	770	795	365	630	435	400	483
AD-55-H	2185	2230	2340	1724	360	890	935	647	945	204	515	710
AD-70-H	2185	2230	2340	2000	360	890	935	647	945	480	655	850

TENSIÓN: A-230V/II/50HZ B-400V/III/50HZ

Get In Touch

Call: 0845 6880112
 Email: info@adremit.co.uk

Our Address

Puravent, Adremit Limited, Unit 5a, Commercial Yard,
 Settle, North Yorkshire, BD24 9RH



IMPULSION TEMPERATURES

Evaporative cooler AD-30 68%

HUMIDITY	EXTERIOR TEMPERATURE							
	30	32	34	36	38	40	42	44
20%	19,4	20,8	21,9	23,2	25	26,3	27,8	29,2
25%	20,6	22,2	23,7	25,1	26,7	28,1	29,7	31,1
30%	22	23,5	25,1	26,7	28,2	29,8	31,5	33
40%	24,3	26	27,7	29,5	31,1	32,9	34,7	36,3
50%	26,5	28,3	30,1	32	33,8	35,7	37,6	39,5

Evaporative cooler AD-35 81%

HUMIDITY	EXTERIOR TEMPERATURE							
	30	32	34	36	38	40	42	44
20%	17,6	18,9	20,3	21,6	22,9	24,2	25,6	27
25%	18,8	20,3	21,7	23,1	24,5	25,9	27,4	28,8
30%	20,1	21,6	23,1	24,5	26,1	27,5	29,1	30,6
40%	22,3	23,9	25,5	27,2	28,8	30,5	32,2	33,7
50%	24,3	26,1	27,9	29,7	31,3	33,1	34,9	36,7

Evaporative cooler AD-40 85%

HUMIDITY	EXTERIOR TEMPERATURE							
	30	32	34	36	38	40	42	44
20%	17,2	18,4	19,8	21	22,4	23,7	25	26,4
25%	18,3	19,8	21,1	23,5	24	25,4	26,8	28,1
30%	19,6	21	22,5	24	25,4	26,9	28,5	30
40%	21,8	23,3	24,9	26,6	28,1	29,9	31,5	33,1
50%	23,8	25,5	27,2	29	30,7	32,5	34,2	36

Evaporative cooler AD-55 80%

HUMIDITY	EXTERIOR TEMPERATURE							
	30	32	34	36	38	40	42	44
20%	17,8	19	20,4	21,7	23,1	24,4	25,7	27,1
25%	19	20,4	21,8	24,3	24,7	26,1	27,6	28
30%	20,2	21,7	23,2	24,7	26,2	27,7	29,3	30,7
40%	22,4	24	25,6	27,3	28	30,6	32,4	34
50%	24,5	26,3	28	29,8	31,5	33,3	35,1	36,9

Evaporative cooler AD-70 73%

HUMIDITY	EXTERIOR TEMPERATURE							
	30	32	34	36	38	40	42	44
20%	18,7	20	21,4	22,7	24,1	25,4	26,8	28,3
25%	19,9	21,4	22,8	24,2	25,8	27,2	28,7	30,2
30%	21,2	22,7	24,2	25,8	27,3	28,8	30,4	32
40%	23,5	25,1	26,7	28,5	30,2	31,9	33,6	35,2
50%	25,5	27,4	29,1	31	32,8	34,6	36,4	38,2

Get In Touch

Call: 0845 6880112
 Email: info@adremit.co.uk

Our Address

Puravent, Adremit Limited, Unit 5a, Commercial Yard,
 Settle, North Yorkshire, BD24 9RH



CE

FLOW/PRESSURE CURVES

COURBES DE DÉBIT/PRESSION AD-30/35/40

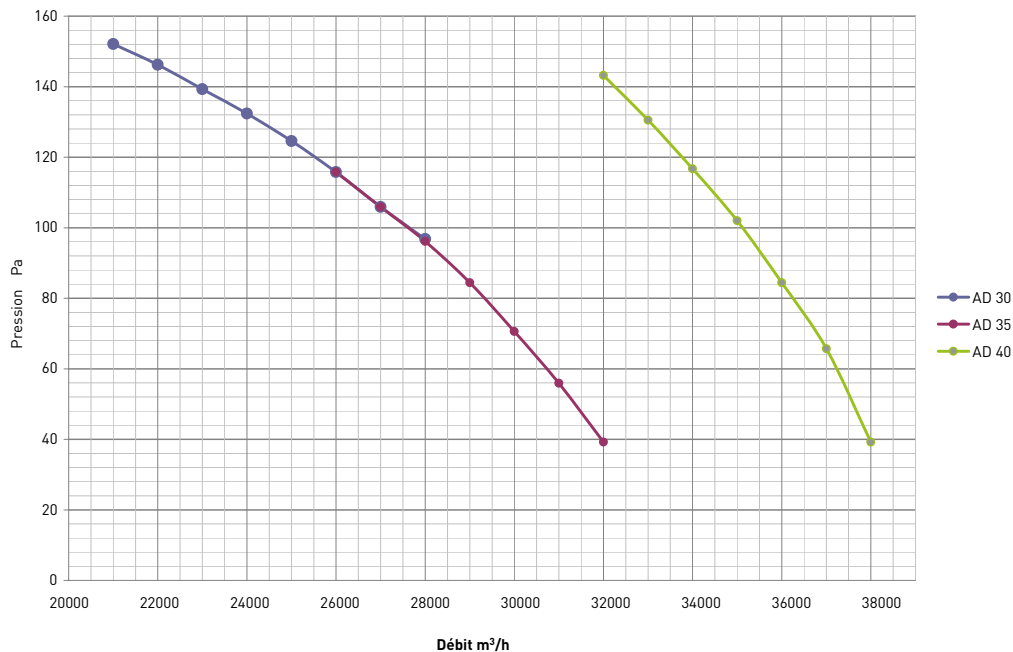

COURBES DE DÉBIT/PRESSION AD-55/70

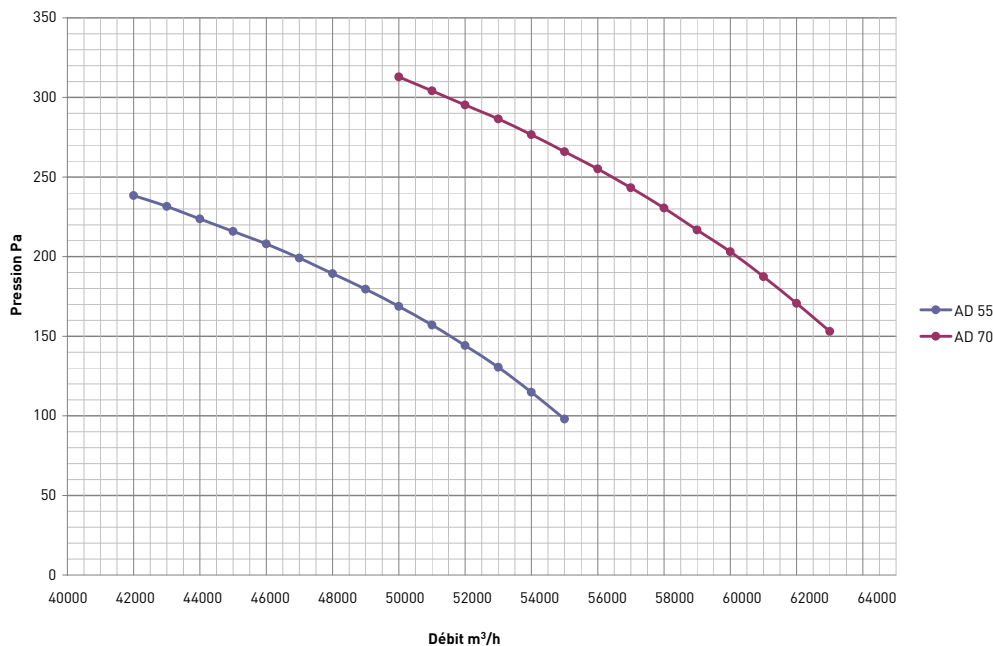

Get In Touch

Call: 0845 6880112
Email: info@adremit.co.uk

Our Address

Puravent, Adremit Limited, Unit 5a, Commercial Yard, Settle, North Yorkshire, BD24 9RH



ROOFTOP INSTALLATION WITH 6-DIRECTION AIR DIFFUSER

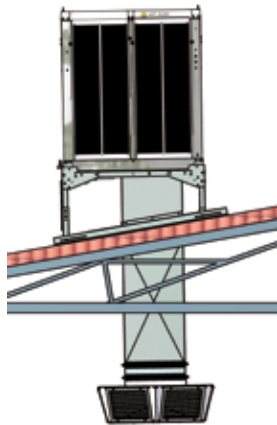

COMPONENTS	AD-30-V	AD-35-V	AD-40-V	AD-55-V	AD-70-V
Basic unit INCLUDES BASE MOUNT WITH FEET	150103021	150103521	150104021	150105523	150107022H
Basic unit, stainless steel INCLUDES BASE MOUNT WITH FEET	150103021I	150103521I	150104021I	150105523I	150107022HI
Electrical panel 1 SPEED	04150155071	04150155071	04150175020	04150110018	04150120038
Electrical panel FREQUENCY CONVERTER	04150120071	04150120071	04150120173	04150120074	04150120075
INSTALLATION ACCESSORIES					
Roof mount base	03091501035	03091501035	03091501035	not available	not available
Flexible joint	1805AV7679	1805AV7679	1805AV7679	1805AV9389	1805AV9389
Straight section, 1m	1805TR30	1805TR30	1805TR30	1805TR55	1805TR55
6-direction air diffuser SINGLE-DEFLECTION GRILLS	03231501031	03231501031	03231501031	03231501055	03231501055
6-direction air diffuser DOUBLE-DEFLECTION GRILLS	03231501131	03231501131	03231501131	03231501151	03231501151
Atmospheric hygrostat	1210HSCF001	1210HSCF001	1210HSCF001	1210HSCF001	1210HSCF001
Protective cover	03021502035	03021502035	03021502035	030215020551	03021502055

ROOFTOP INSTALLATION WITH AIR DUCTS AND IMPULSION VENTS

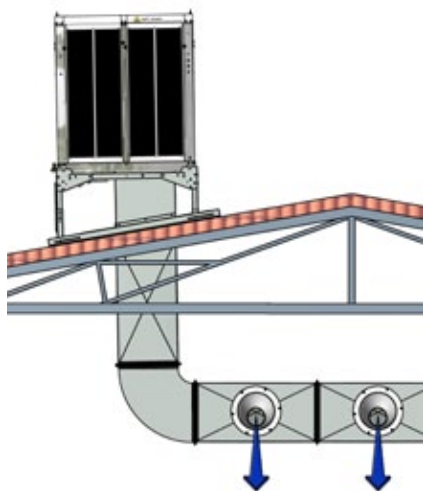

COMPONENTS	AD-30-V	AD-35-V	AD-40-V	AD-55-V	AD-70-V
Basic unit	150103021	150103521	150104021	150105523	150107022H
INCLUDES BASE MOUNT WITH FEET	150103021	150103521	150104021	150105523	150107022H
Basic unit, stainless steel INCLUDES BASE MOUNT WITH FEET	150103021I	150103521I	150104021I	150105523I	150107022HI
Electrical panel 1 SPEED	04150155071	04150155071	04150175020	04150110018	04150120038
Electrical panel FREQUENCY CONVERTER	04150120071	04150120071	04150120173	04150120074	04150120075
INSTALLATION ACCESSORIES					
Roof mount base	03091501035	03091501035	03091501035	not available	not available
Flexible joint	1805AV7679	1805AV7679	1805AV7679	1805AV9389	1805AV9389
Straight section, 1m	1805TR30	1805TR30	1805TR30	1805TR55	1805TR55
90° curve	1805TC30	1805TC30	1805TC30	1805TC55	1805TC55
Impulsion vents 10 UNITS	04150PAKCON0	04150PAKCON0	04150PAKCON0	04150PAKCON0	04150PAKCON0
Atmospheric hygrostat	1210HSCF001	1210HSCF001	1210HSCF001	1210HSCF001	1210HSCF001
Protective cover	03021502035	03021502035	03021502035	030215020551	03021502055

NOTE: THIS IS A SAMPLE INSTALLATION SCHEME. THE ACTUAL INSTALLATION WILL BE PERFORMED IN COMPLIANCE WITH STANDARDS IN EFFECT IN THE COUNTRY WHERE THE EQUIPMENT WILL BE INSTALLED.



WALL INSTALLATION WITH 3-DIRECTION AIR DIFFUSER

COMPONENTS	AD-30-V	AD-35-V	AD-40-V	AD-55-V	AD-70-V
Basic unit INCLUDES BASE MOUNT WITH FEET	150103021	150103521	150104021	150105523	150107022H
Basic unit, stainless steel INCLUYE BANCADA BASE CON PATAS	1501030211	1501035211	1501040211	1501055231	150107022HI
Electrical panel 1 SPEED	04150155071	04150155071	04150175020	04150110018	04150120038
Electrical panel con CONVERTIDOR DE FRECUENCIA	04150120071	04150120071	04150120173	04150120074	04150120075
INSTALLATION ACCESSORIES					
Wall mount base	03091501026	03091501026	03091501026	not available	not available
Flexible joint	1805AV7679	1805AV7679	1805AV7679	1805AV9389	1805AV9389
Straight section, 1m	1805TR30	1805TR30	1805TR30	1805TR55	1805TR55
90° curve	1805TC30	1805TC30	1805TC30	1805TC55	1805TC55
3-direction air diffuser	03231501132	03231501132	03231501132	03231501152	03231501152
Diffusion coupling	180579768585	180579768585	180579768585	180585857976	180585857976
Atmospheric hygrostat	1210HSCF001	1210HSCF001	1210HSCF001	1210HSCF001	1210HSCF001
Protective cover	03021502035	03021502035	03021502035	030215020551	03021502055

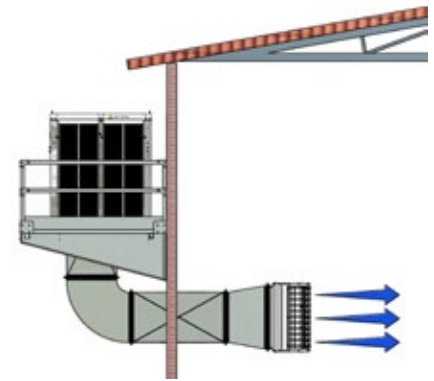

WALL INSTALLATION WITH AIR DUCTS AND IMPULSION VENTS

COMPONENTS	AD-30-V	AD-35-V	AD-40-V	AD-55-V	AD-70-V
Basic unit INCLUDES BASE MOUNT WITH FEET	150103021	150103521	150104021	150105523	150107022H
Basic unit, stainless steel INCLUDES BASE MOUNT WITH FEET	1501030211	1501035211	1501040211	1501055231	150107022HI
Electrical panel 1 SPEED	04150155071	04150155071	04150175020	04150110018	04150120038
Electrical panel FREQUENCY CONVERTER	04150120071	04150120071	04150120173	04150120074	04150120075
INSTALLATION ACCESSORIES					
Wall mount base	03091501026	03091501026	03091501026	not available	not available
Flexible joint	1805AV7679	1805AV7679	1805AV7679	1805AV9389	1805AV9389
Straight section, 1m	1805TR30	1805TR30	1805TR30	1805TR55	1805TR55
90° curve	1805TC30	1805TC30	1805TC30	1805TC55	1805TC55
Impulsion vents 10 UNITS	04150PAKCONO	04150PAKCONO	04150PAKCONO	04150PAKCONO	04150PAKCONO
Atmospheric hygrostat	1210HSCF001	1210HSCF001	1210HSCF001	1210HSCF001	1210HSCF001
Protective cover	03021502035	03021502035	03021502035	030215020551	03021502055

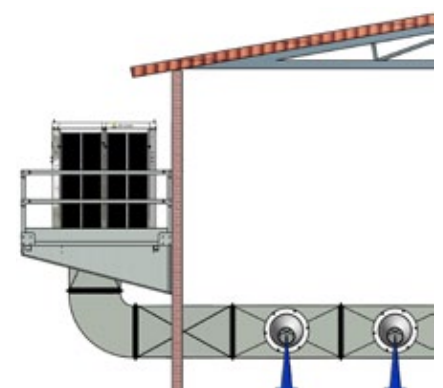

NOTE: THIS IS A SAMPLE INSTALLATION SCHEME. THE ACTUAL INSTALLATION WILL BE PERFORMED IN COMPLIANCE WITH STANDARDS IN EFFECT IN THE COUNTRY WHERE THE EQUIPMENT WILL BE INSTALLED.

Get In Touch

Call: 0845 6880112
Email: info@adremit.co.uk

Our Address

Puravent, Adremit Limited, Unit 5a, Commercial Yard, Settle, North Yorkshire, BD24 9RH



GROUND SURFACE INSTALLATION WITH 3-DIRECTION AIR DIFFUSER

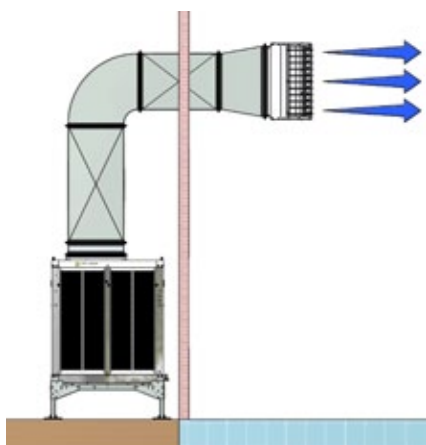

COMPONENTS	AD-30-VS	AD-35-VS	AD-40-VS	AD-55-VS	AD-70-VS
Basic unit INCLUDES BASE MOUNT WITH FEET	150103031	150103531	150104031	150105533	150107032H
Basic unit, stainless steel INCLUDES BASE MOUNT WITH FEET	150103031I	150103531I	150104031I	150105533I	150107032HI
Electrical panel 1 SPEED	04150155071	04150155071	04150175020	04150110018	04150120038
Electrical panel FREQUENCY CONVERTER	04150120071	04150120071	04150120173	04150120074	04150120075
INSTALLATION ACCESSORIES					
Flexible joint	1805AV7679	1805AV7679	1805AV7679	1805AV9389	1805AV9389
Straight section, 1m	1805TR30	1805TR30	1805TR30	1805TR55	1805TR55
90° curve	1805TC30	1805TC30	1805TC30	1805TC55	1805TC55
Diffusion coupling	180579768585	180579768585	180579768585	180585857976	180585857976
3-direction air diffuser	03231501132	03231501132	03231501132	03231501152	03231501152
Atmospheric hygrostat	1210HSCF001	1210HSCF001	1210HSCF001	1210HSCF001	1210HSCF001
Protective cover	03021502035W	03021502035W	03021502035W	030215020551W	03021502055W

GROUND SURFACE INSTALLATION WITH AIR DUCTS AND IMPULSION VENTS

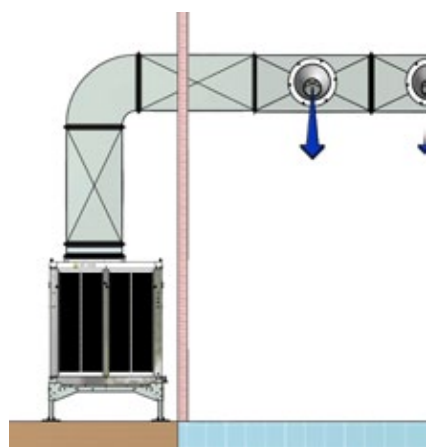

COMPONENTS	AD-30-VS	AD-35-VS	AD-40-VS	AD-55-VS	AD-70-VS
Basic unit INCLUDES BASE MOUNT WITH FEET	150103031	150103531	150104031	150105533	150107032H
Basic unit, stainless steel INCLUDES BASE MOUNT WITH FEET	150103031I	150103531I	150104031I	150105533I	150107032HI
Electrical panel 1 SPEED	04150155071	04150155071	04150175020	04150110018	04150120038
Electrical panel FREQUENCY CONVERTER	04150120071	04150120071	04150120173	04150120074	04150120075
INSTALLATION ACCESSORIES					
Flexible joint	1805AV7679	1805AV7679	1805AV7679	1805AV9389	1805AV9389
Straight section, 1m	1805TR30	1805TR30	1805TR30	1805TR55	1805TR55
90° curve	1805TC30	1805TC30	1805TC30	1805TC55	1805TC55
Impulsion vents 10 UNITS	04150PAKCONO	04150PAKCONO	04150PAKCONO	04150PAKCONO	04150PAKCONO
Atmospheric hygrostat	1210HSCF001	1210HSCF001	1210HSCF001	1210HSCF001	1210HSCF001
Protective cover	03021502035W	03021502035W	03021502035W	030215020551W	03021502055W

NOTE: THIS IS A SAMPLE INSTALLATION SCHEME. THE ACTUAL INSTALLATION WILL BE PERFORMED IN COMPLIANCE WITH STANDARDS IN EFFECT IN THE COUNTRY WHERE THE EQUIPMENT WILL BE INSTALLED.

WALL INSTALLATION WITH 3-DIRECTION AIR DIFFUSER

COMPONENTS	AD-30-H	AD-35-H	AD-40-H	AD-55-H	AD-70-H
Basic unit INCLUDES BASE MOUNT WITH FEET	150103011	150103511	150104011	150105513	150107012H
Basic unit, stainless steel INCLUDES BASE MOUNT WITH FEET	150103011I	150103511I	150104011I	150105513I	150107012HI
Electrical panel 1 SPEED	04150155071	04150155071	04150175020	04150110018	04150120038
Electrical panel FREQUENCY CONVERTER	04150120071	04150120071	04150120173	04150120074	04150120075
INSTALLATION ACCESSORIES					
Wall mount base	03091501026	03091501026	03091501026	not available	not available
Flexible joint	1805AV7679	1805AV7679	1805AV7679	1805AV9389	1805AV9389
Straight section, 1m	1805TR30	1805TR30	1805TR30	1805TR55	1805TR55
Diffusion coupling	180579768585	180579768585	180579768585	180585857976	180585857976
3-direction air diffuser	03231501132	03231501132	03231501132	03231501152	03231501152
Atmospheric hygrostat	1210HSCF001	1210HSCF001	1210HSCF001	1210HSCF001	1210HSCF001
Protective cover	03021502035	03021502035	03021502035	030215020551	03021502055

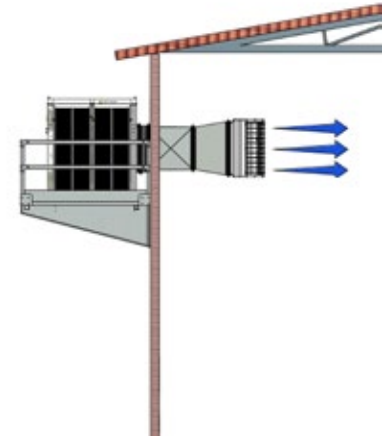
WALL INSTALLATION WITH AIR DUCTS AND IMPULSION VENTS

COMPONENTS	AD-30-H	AD-35-H	AD-40-H	AD-55-H	AD-70-H
Basic unit INCLUDES BASE MOUNT WITH FEET	150103011	150103511	150104011	150105513	150107012H
Basic unit, stainless steel INCLUDES BASE MOUNT WITH FEET	150103011I	150103511I	150104011I	150105513I	150107012HI
Electrical panel 1 SPEED	04150155071	04150155071	04150175020	04150110018	04150120038
Electrical panel FREQUENCY CONVERTER	04150120071	04150120071	04150120173	04150120074	04150120075
INSTALLATION ACCESSORIES					
Wall mount base	03091501026	03091501026	03091501026		
Flexible joint	1805AV7679	1805AV7679	1805AV7679	1805AV9389	1805AV9389
Straight section, 1m	1805TR30	1805TR30	1805TR30	1805TR55	1805TR55
Impulsion vents 10 UNITS	04150PAKCONO	04150PAKCONO	04150PAKCONO	04150PAKCONO	04150PAKCONO
Atmospheric hygrostat	1210HSCF001	1210HSCF001	1210HSCF001	1210HSCF001	1210HSCF001
Protective cover	03021502035H	03021502035H	03021502035H	030215020551H	03021502055H

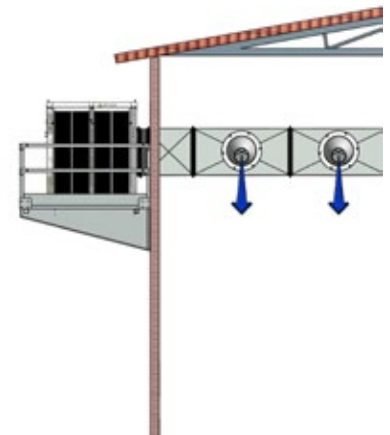

NOTE: THIS IS A SAMPLE INSTALLATION SCHEME. THE ACTUAL INSTALLATION WILL BE PERFORMED IN COMPLIANCE WITH STANDARDS IN EFFECT IN THE COUNTRY WHERE THE EQUIPMENT WILL BE INSTALLED.

Get In Touch

Call: 0845 6880112
Email: info@adremit.co.uk

Our Address

Puravent, Adremit Limited, Unit 5a, Commercial Yard, Settle, North Yorkshire, BD24 9RH