

ST1

**Straight Side Single Crank
Precision Presses**



© The contour of upgraded model
is only for reference

80. 110. 160. 200. 260. 300 ton

Intelligent Forming Productivity Management System

Data-Driven Decision

Agile Production

Real Time Management

Smart Networking

Application Layer

Network Layer

Physical / Sensing Layer

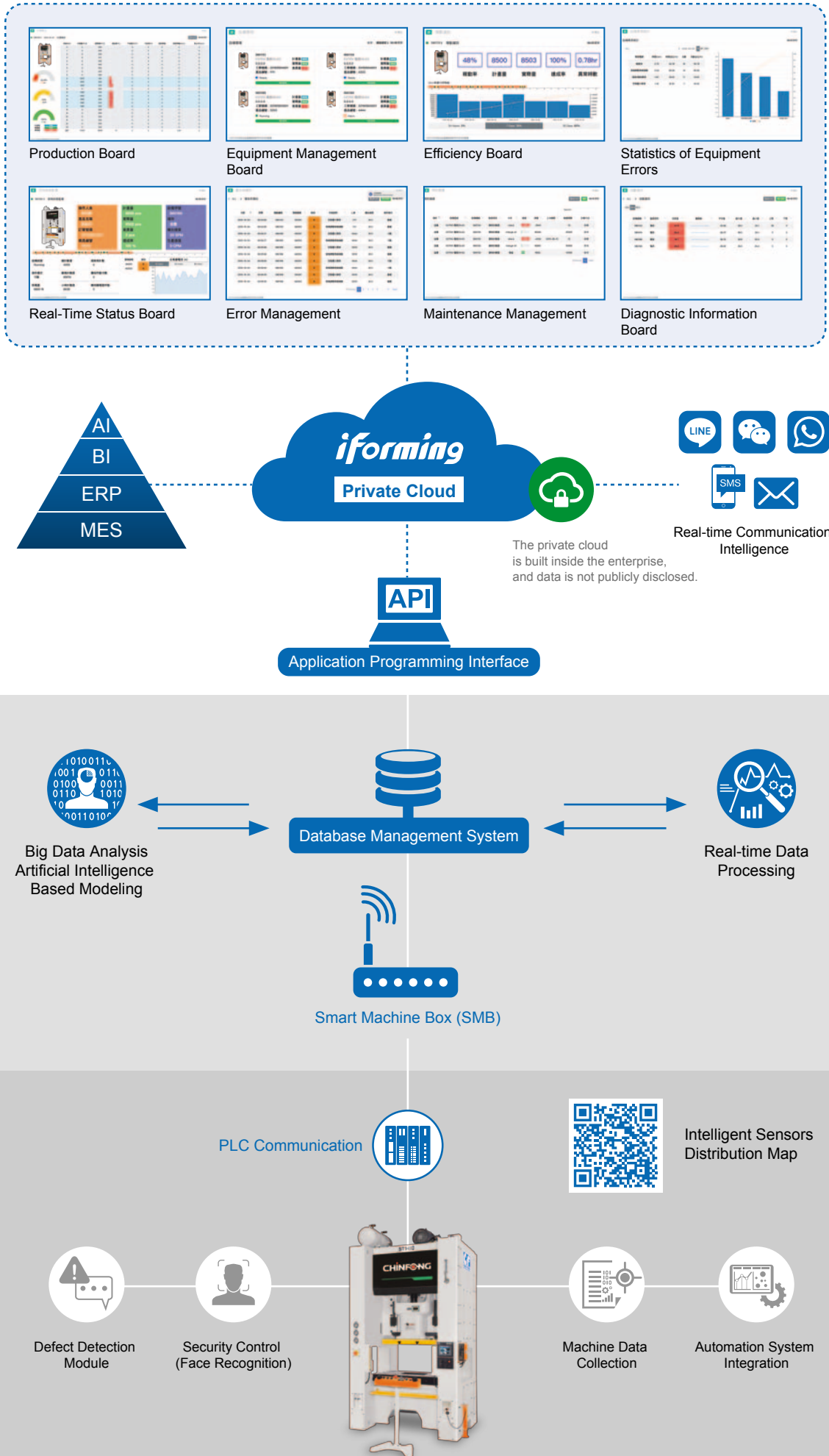



© The contour of upgraded model is only for reference

Feature introduction

- High Precision Stamping Solution
- Reduced Noise & Vibration
- User-Friendly Operator Controls
- Reduced Angular Deflection
- Minimal Frame Deflection
- Resistant To Off-center Loading
- Easy Adaptation Of Various Press
- High Driving Torque Wet Clutch & Brake
- Box Type 6-point Gibs
- Ultra Rigid Steel Frame
- Minimum Total Clearance
- Electronic Crank Angle Indicator
- HMI Operation Panel

Specification

Model			ST1-80			ST1-110			ST1-160			ST1-200			ST1-260			ST1-300	
Type			S	H	L	S	H	L	S	H	L	S	H	L	S	H	L	S	XL
Capacity	Ton		80			110			160			200			260			300	
Rated tonnage point (above B.D.C.)	mm		5	3.2	5	5	3.2	5	6	4	6	6	4	6	6	4	6	6	6
Stroke length	mm		100	60	150	110	70	180	130	80	200	150	100	200	180	100	250	180	300
Strokes per minute	Fixed Speed	S.P.M	80	100	60	70	90	50	60	80	45	50	65	35	45	55	30	45	30
	Variable Speed	S.P.M	50-100	65-140	40-75	45-90	60-130	30-65	30-70	50-100	20-50	35-70	45-95	20-50	30-60	35-75	20-40	30-50	20-35
Die height (S.D.A.U.)	mm		355	375	330	385	405	350	435	460	400	475	500	450	485	525	450	610	550
Slide area (L.R. x F.B.)	mm		560x460			650x520			700x580			850x650			920x700			920x700	
Bolster area (L.R. x F.B.)	A type	mm	780x600			900x680			1000x760			1150x820			1300x840			1300x840	
	B type	mm	1000x600			1150x680			1250x760			1400x820			1550x840			1550x840	
Bolster thickness	mm		100			120			150			160			180			200	
Side opening (L.R. x H)	mm		650x460			750x500			800x560			900x610			950x660			950x700	
Slide adjustment	mm		80			90			100			110			120			120	
Maximun upper die weight	kg		345			450			540			800			800			800	
Main motor	HpxP		10x4			15x4			20x4			20x4			25x4			30x4	
Slide adjusting motor	KWxP		0.4x4			0.4x4			0.75x4			0.75x4			1.5x4			1.5x4	
Working height	mm		830			845			915			1020			1120			1120	
Die cushion			D3-300-70			D4-350-80			D5-400-80			D6-400-100			D7-550-100			D7-550-100	
Capacity	Ton		6.3			8			10			14			14			14	
Stroke	mm		70			80			80			100			100			100	
Pad area (L.R. x F.B.)	mm		410x260			500x300			540x350			640x470			700x520			700x520	







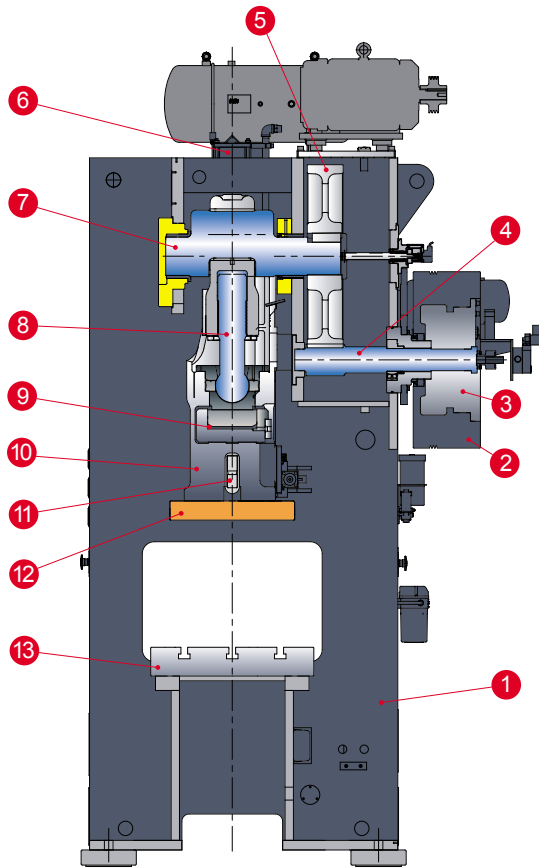

ST1

Straight Side Single Crank Precision Presses

1. Press Frame
2. Flywheel
3. Wet Clutch & Brake
4. Pinion Drive Shaft
5. Main Gear
6. Counter Balancer
7. Crankshaft
8. Adjusting Screw
9. Hydraulic Overload Protector
10. Slide
11. Slide Knockout
12. Slide Plate (Detachable)
13. Bolster



High Driving Torque Wet Clutch & Brake

	
Superior Performance	Noise Reduction
	
Improved Efficiency	Dust-free Operation
	
Low Inertia	Prolong Lifespan
	
High Torque	Less Maintenance Cost

Ultra Rigid Steel Frame

The CHIN FONG ST1 Series is designed to resist deflection, and provide accurate pressings and longer die life, even at full tonnage loads. The heavy, one-piece welded steel frame is fully stress relieved and stands solid for challenging stamping applications.

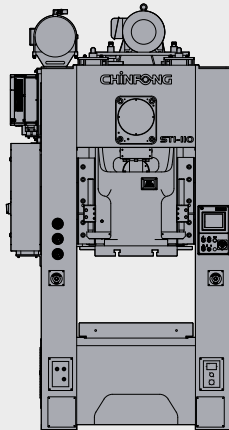

Box Type 6-point Gibs

One-piece, full-length, box type gibs assure slide guiding precision. Force is delivered vertically, minimizing lateral thrust and, consequently, reducing off-center loading and friction in the gibs.

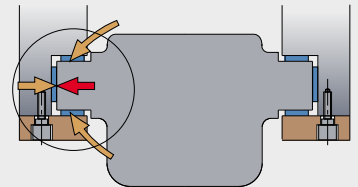

Highly Responsive Hydraulic Overload Protector (H.O.L.P.)

1. Piston
2. Hydraulic Overload Protector Cylinder
3. H. O. L. P.
4. Oil Tank

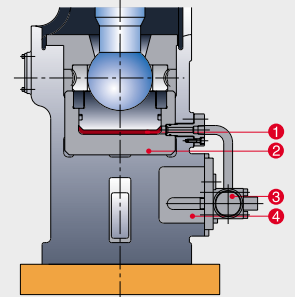

Chin Fong's fast response H.O.L.P. will relieve the pressure of a tonnage overload in milliseconds, causing the press to stop simultaneously. Press and toolings can therefore be protected effectively. Hydraulic pressure of the system can be rebuilt by pushing the reset button. Then, normal operation can be resumed by inching the slide to T.D.C position.

Stroke-Capacity Curve (S)

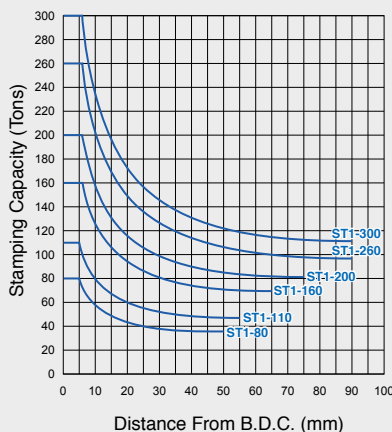

Stroke-Capacity Curve (H)

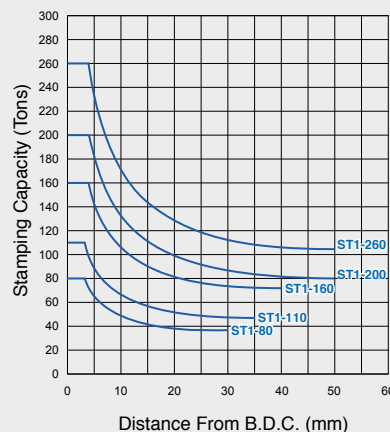

Stroke-Capacity Curve (L)

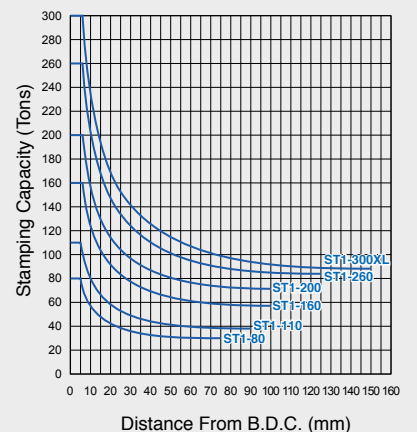

T-Slot Detail

Slide Plate

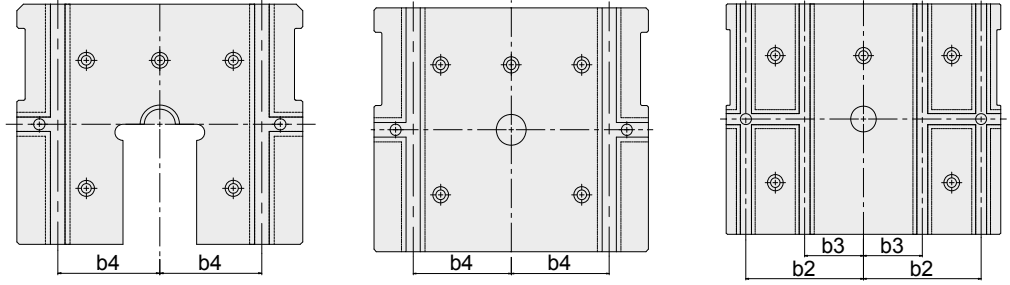
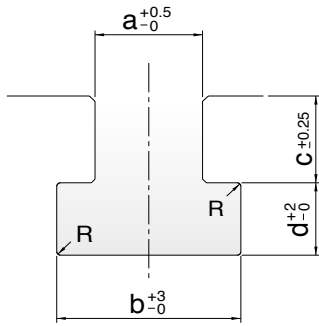

unit: mm

Dim.	Type	unit: mm	
		A	B
a		22	28
b		37	48
c		24	28
d		16	20
R		1	1

Model	ST1-80	ST1-110	ST1-160	ST1-200	ST1-260	ST1-300
Slide Plate Area (L.R. x F.B.)	560x460	650x520	700x580	850x650	920x700	920x700
Type of T-Slot	A	B	B	B	B	B
Shank Hole Dia.	Ø 50	Ø 50	Ø 65	Ø 65	Ø 65	Ø 65
b2	-	-	300	300	300	300
b3	-	-	150	150	150	150
b4	150	150	-	-	-	-

Bolster

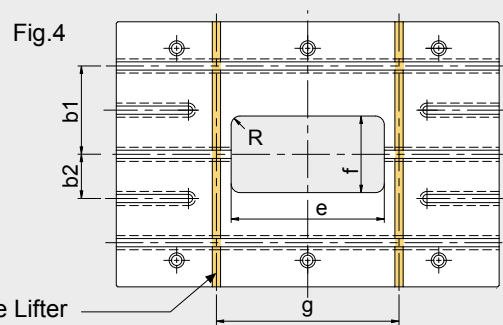
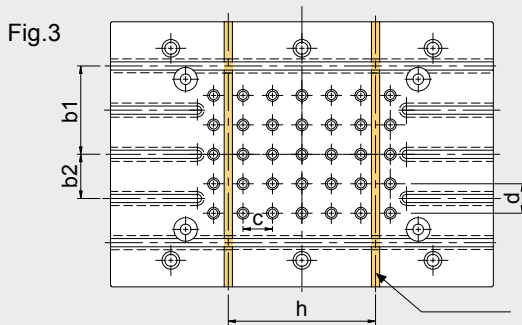
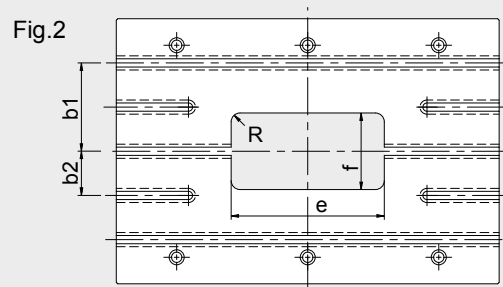
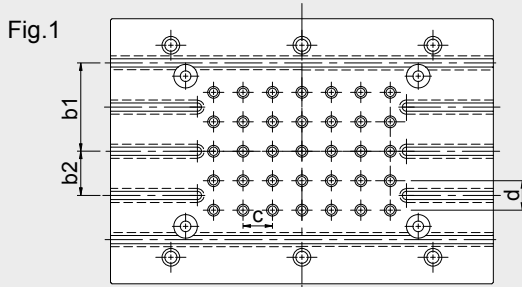

with "U" slot for die Lifter

unit: mm

Model	ST1-80	ST1-110	ST1-160	ST1-200	ST1-260	ST1-300
Type of T-Slot	A	B	B	B	B	B
No. of T-Slot	3	3	3	5	5	5
No. of Pin Hole x Dia.	24xØ20 ^{+0.5/-0.1}	24xØ28 ^{+0.5/-0.1}	24xØ28 ^{+0.5/-0.1}	35xØ28 ^{+0.5/-0.1}	35xØ28 ^{+0.5/-0.1}	35xØ28 ^{+0.5/-0.1}
cx	75x75	90x90	100x100	95x95	100x100	100x100
b1	150	200	225	265	300	300
b2	-	-	-	115	150	150
ex	360x180	400x200	440x220	480x240	520x260	520x260
R	30	30	30	30	30	30
g	410	480	520	580	620	620
h	300	360	400	475	500	500

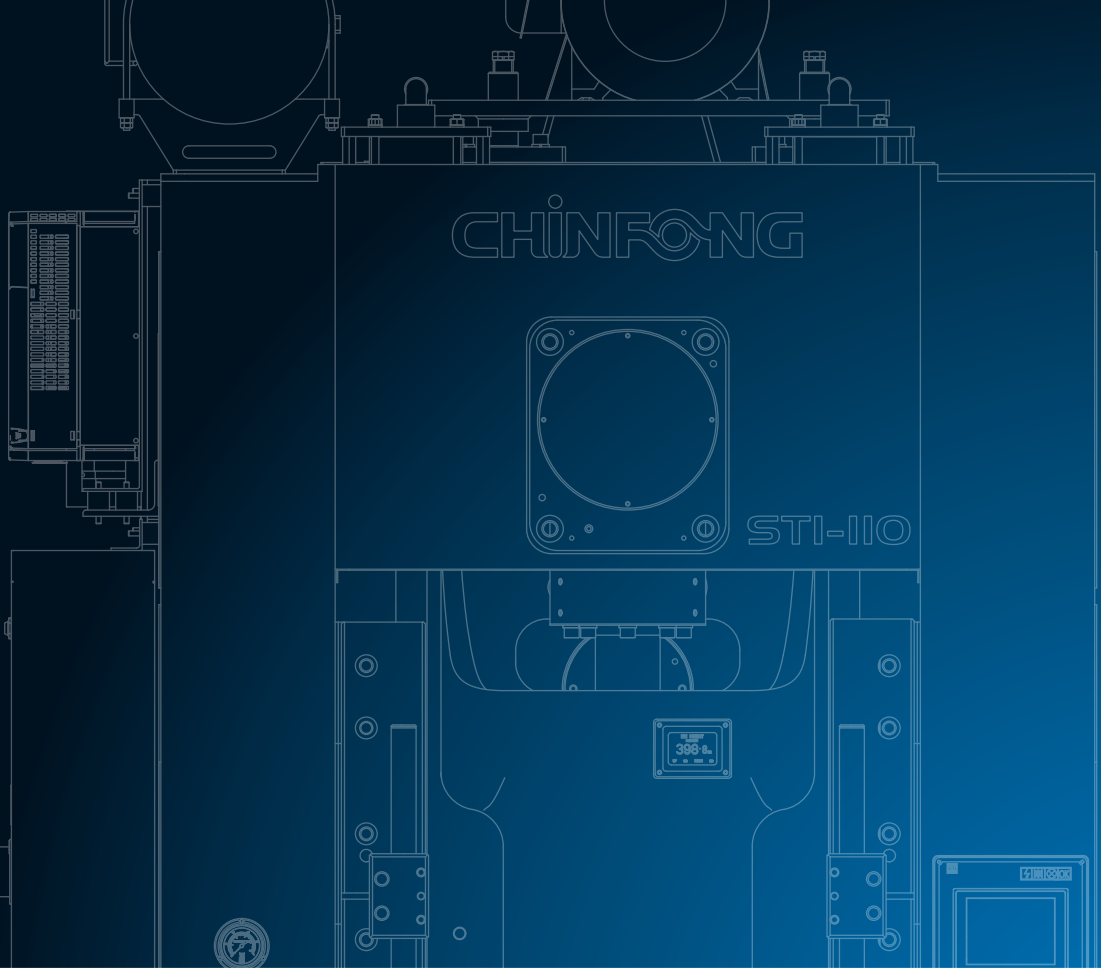

INNOVATION, SERVICE, COMMITMENT

Mechanical power press manufacturer

金豐機器工業股份有限公司

CHIN FONG MACHINE INDUSTRIAL CO., LTD.

HEAD OFFICE & FACTORY:

總公司：台灣彰化市彰水路186號
No. 186, Chang Shui Road, Chang Hua, Taiwan
<https://www.chinfong.com>
E-mail: sales@chinfong.com.tw
TEL: +886-4-752-4131
TEL: 0800-006889

北區營業所 **TAIPEI OFFICE**
TEL: +886-3-435-5058

南區營業所 **KAOSIUNG OFFICE**
TEL: +886-7-238-5689~90

OVERSEAS BRANCHES

金豐 (中國) 機械工業有限公司

CHIN FONG (CHINA) MACHINE INDUSTRIAL CO., LTD.

浙江省寧波市鎮海經濟開發區金豐路66號
No. 66, Chin Fong Road, Zhenhai Economic Development Zone, Ningbo, China
<http://www.chinfong.com.cn>
E-mail: sales@chinfong.com.cn
TEL: +86-574-8630-1222

金豐 (江蘇) 機械工業有限公司

CHIN FONG (JIANGSU) MACHINE INDUSTRIAL CO., LTD.

江蘇省淮安市經濟技術開發區集賢路6號
No. 6, Jixian Road, Huai'an Economic Technological Development Zone, Jiangsu, China
E-mail: sales@cfs.chinfong.com
TEL: +86-517-83909828

U.S.A.: STAMTEC INC.

<http://www.stamtec.com>
E-mail: sales@stamtec.com
TEL: +1-931-393-5050

THAILAND: CHIN FONG (THAILAND) CO., LTD.

E-mail: cft@chinfong.com
TEL: +66-2-919-6820~2

INDONESIA: PT. CHIN FONG INDONESIA

E-mail: chinfong-indonesia@chinfong.web.id
TEL: +62-21-2946-5586~7

MALAYSIA: CHIN FONG MACHINE (M) SDN BHD

E-mail: chinfongmachine@gmail.com
TEL: +60-3-3885-3155

MEXICO: Stamtec Equipos de Estampacion de México, S de RL de CV.

E-mail: ventas@stamtec.com
TEL: +52-44-2101-9555



The contents disclosed in this catalogue, including pictures, data, wordings & drawings, are exclusive property of Chin Fong Machine Industrial Co., Ltd. Unauthorized duplication or use part or whole of this catalogue is prohibited. Chin Fong reserves rights to modify the specifications & features, due to product improvements, without further notification. Optional accessories showing on this picture are for reference only.
以上資料及圖片均屬本公司之產權，不得抄襲仿冒。且本公司得因產品之改良逕行設計變更，不另行通知。
照片內之實物屬選用配備，僅供參考。