

Fuel oil meters

Applications

- Flow measurement of mineral oils such as heating or propellant fuels
- In burners, on board ships, land vehicles and fixed installations
- Marine and metrological type approvals (optional)



Features

- The complete range of products offering the best solutions for the measurement of oil consumption
- State-of-the-art design with electronic counter, flow indication, analogue and digital output signals and limiting value switch
- Mounting on the pressure or suction side of a pump, with no straight inlets or outlets required
- Independent of viscosity and temperature
- High vibration resistance
- Classical version with mechanical display

Your benefits

- The reliable solution with everything from a single supplier
- Reliable monitoring and flexible control of the system. Simplifies burner settings and optimising consumption
- Highly flexible mounting with very small space requirements
- Accurate measurements
- Maximum safety in the shipbuilding and automobile industries
- Cost-effective metering point

The right product for every application

Range CONTOIL® Control VZF 15 ... 50



with multifunctional display and parameterisable outputs

Electronic display of

- totaliser, total and resettable volume
- actual flow rate
- other flow parameters

Output signals for

- volume pulses
- actual flow rate
- limiting values (Q_{min} , Q_{max})

Simple to operate

Interactive parameter input

External power supply

Housing with threaded or flanged connections

Main characteristic data:

- flow range 10 ... 30 000 l/h
- temperature ranges 130 and 180° C
- nominal pressure PN 16 and 25 bar (PN 40 on request)

Page 5

Range CONTOIL® Classic VZO 4 ... 50



total volume display and remote transmission

Total volume display on roller counter

Option: Reed pulser RE or RV for remote totalisation

Option: Inductive IN pulser for control purposes

Housing with threaded or flanged connections

Main characteristic data:

- flow range 0.5 ... 30.000 l/h
- temperature ranges 60, 130 and 180° C
- nominal pressure PN 16, PN 25 and PN 40 bar



Page 9

**Range CONTOIL®
VZFA / VZOA**



optimal solution for special applications such as:

- differential measurement (VZFA / VZOA 15...50)
- certification/official verification for commercial transactions (VZOA 4...50)
- engine test benches (VZFA / VZOA 15...50)

VZFA

Electronic display of

- totaliser, total and resettable volume
- actual flow rate
- other flow parameters

Output signals for

- volume pulses
- actual flow rate
- limiting values (Q_{min} , Q_{max})

Simple to operate

Interactive parameter input

External power supply

VZOA 4 and 8

- Volume display on roller counter



VZOA 15...50

- Volume display on roller counter

Option: IN inductive pulser for control purposes

Option: RV Reed pulser for remote totalisation, integrated into the roller counter

Housing with threaded or flanged connections

Main characteristic data:

- flow range 10 ... 30,000 l/h
- temperature ranges 130 and 180° C
- nominal pressure PN 16 and PN 25 bar (PN 40 on request)

with special pairing for minimum measurement variance.

Page 17

Accessories

Page 23

APPENDIX:

Meter data

Page 24

Selection of the optimal meter

Page 31

Fuel oils

Page 32

How to obtain an optimal measurement

Page 33

Application examples

Page 37



If flow meters are needed for hazardous areas, please contact your nearest sales office.

CONTOIL[®], the world's most frequently used oil consumption meter

Leading manufacturers of oil burners and operators of heating systems, ships or diesel engines rely on CONTOIL[®] fuel oil meters - and with good reasons.

The advantages of CONTOIL[®] fuel oil meters – your benefits

You can decide which of these many benefits are the most important for you:

- the optimal solution for every application
- simple burner setting with flow rate display (types VZF)
- simple consumption monitoring with limiting value switch Q_{\min}/Q_{\max} (types VZF)
- manual dosing feature, with a resettable counter (types VZF)
- can be mounted on the pressure or suction side of a pump
- space-saving installation, because no straight inlet/outlet sections are needed
- flexible mounting of the meter in horizontal, vertical or inclined positions
- accurate measurement result, since the reading is independent of the temperature and viscosity of the fluid
- minimum failure costs due to simple function monitoring, rapid fault analysis and the possibility of simple repairs on site

Areas of application

- to measure heating fuel consumption by oil burners (for example, in heating boilers, industrial furnaces, tar processing plants, ships boilers)
- to measure propellant fuel consumption by motors and engines (such as diesel locomotives, construction machinery and ships, or in emergency power units, combined heating and power stations)
- consumption monitoring and optimisation
- flow measurement for mineral oils
- optional remote processing and integration into superior systems
- manual dosing / batching
- flow measurement for machine and motor/engine oils
- engine test benches

Fuel types

- heating fuel extra light / light, medium, heavy
- naphtha
- diesel
- petrol
- and other lubricating liquids

CONTOIL® Control VZF 15...50

Technical data 1)



- display of total volume, resettable volume, and flow rate in m³, litres or US gallons 2)
- user-friendly, interactive parameter input
- fuel oil meter with threaded or flanged connections
- for mounting in horizontal or vertical positions

Versions available on request:

- different flange drillings, such as ANSI, JIS

Type		VZF 15	VZF 20	VZF 25	VZF 40	VZF 50	
Nominal diameter	DN	mm	15	20	25	40	50
		inch	1/2	3/4	1	1 1/2	2
Installation length		mm	165	165	190	300	350
Nominal pressure with threaded ends with flanges	PN	bar	16	16	16	16	16
	PN	bar	25	25	25	25	25
Maximum temperature	T _{max}	°C	130, 180				
Maximum flow rate	Q _{max} 3)	l/h	600	1500	3000	9000	30000
Nominal flow rate	Q_n 3)	l/h	400	1000	2000	6000	20000
Minimal flow rate	Q _{min}	l/h	10	30	75	225	750
Approx. starting flow rate		l/h	4	12	30	90	300
Max. permissible error			± 1% of actual value				
Repeatability			± 0.2%				
Safety filter mesh size		mm	0.400	0.400	0.400	0.800	0.800
Dirt filter mesh size		mm	0.250	0.400	0.400	0.600	0.600
Volume of measuring chamber		approx. cm ³	12	36	100	330	1200
Housing finish			enamelled red RAL 3013				
Weight with threaded ends 4)		approx. kg	2.2	2.5	4.2	17.3	–
	with flanges PN 25	approx. kg	3.8	4.5	7.5	20.3	41.0
Smallest readable amount:							
Total volume		l	No decimal places				
Resettable volume		l	1 decimal place				
Digital flow rate display		l/h	1 decimal place				
Registration capacity		l	100 000 000				
Registration time at Q _n until overrunning to zero		h	128 000	100 000	50 000	16 667	5 000
Outputs 5)							
Pulse value for totalisator		Vol./pulse	pulse value and width parameterisable				
Current 4..20 mA for flowrate		I ₄ /Q ₁ , I ₂₀ /Q ₂	flow rates to 4 and 20 mA parameterisable				
Frequency for flow		f ₁ /Q ₁ , f ₂ /Q ₂	frequency and flowrate parameterisable				
Limiting switch		Q _{min} , Q _{max}	minimum, maximum and hysteresis parameterisable				

1) Manufacturer's specification, valid for the reference conditions as specified under "APPENDIX: Meter data".

2) 1 US gallon corresponds to 3.785 litres.

3) For burners and engines or motors, the meter must be selected on the basis of the permanent flow rate. For higher viscosities, or if the meter is installed on the suction side, the pressure drop and any reduction in the measuring range must be taken into consideration.

4) Weight without couplings.

5) Two freely selectable outputs are available, totally independent of each other.

Pressure drop curves

See "APPENDIX: Meter data"

Electronic display

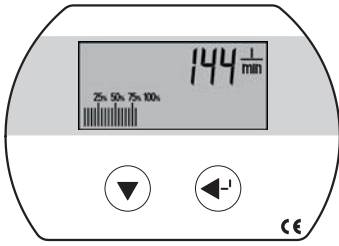

- | | |
|--------------------|---|
| Display values: | <ul style="list-style-type: none"> • total volume, resettable volume, flow rate • In the information menu, hours of operation and other information can be obtained |
| Display: | <ul style="list-style-type: none"> • 8-character LCD with identification of the parameter, height of numbers: 8 mm, flow rate (meter load) using bar indicator |
| Temperature: | <ul style="list-style-type: none"> • ambient temperature -25 ... +70° C, • storage temperature -25 ... +85° C |
| Safety: | <ul style="list-style-type: none"> • CE, vibration and shock test to DIN IEC 68 |
| Power supply: | <ul style="list-style-type: none"> • 24 V DC (6...30 V DC) |
| Data preservation: | <ul style="list-style-type: none"> • by non-volatile memory (EEPROM) |
| Protection class: | <ul style="list-style-type: none"> • IP66 (IEC 60529) against water jets and dust |

Outputs

Four different output functions are available:

- Pulser for volume pulses with programmable pulse value (for external totaliser)
- Analogue current output 4...20 mA corresponding to flow rate
- Frequency output 0...100 Hz corresponding to flow rate
- Switching function (limiting value switch) specified by programmable upper and lower flow rates

Except for the analogue output function, any two of the remaining three functions can always be used simultaneously. This results in two types of connection:

- | | |
|---|---|
| <ul style="list-style-type: none"> • 1 potential-free digital output (Rel. 1), parameterisable to one of the three functions described below. • 1 passive analogue 4...20 mA output also used for powering the meter. | <ul style="list-style-type: none"> • 2 potential-free digital outputs (Rel. 1 + Rel. 2), each parameterisable to one of the three functions described below. • the analogue output is not available in this case. The power, however, is supplied over these terminals. |
|---|---|

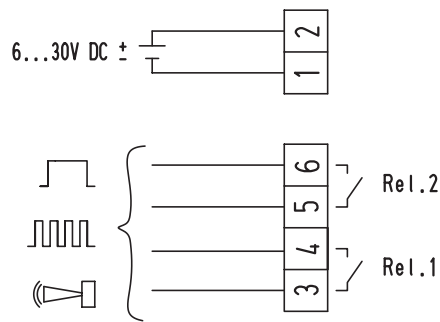
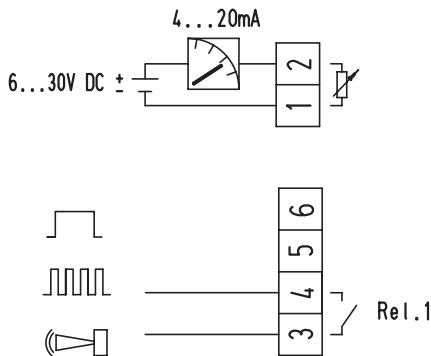

Specification of the outputs

Passive analogue output (1-2)

- Voltage range U: 6...30V DC
- Maximum load R_L : (U-5) V / 0.0215A [Ω]
- Resolution: 16 Bit
- Max. error: ± 0.2 mA
- Update interval: < 1s

Digital outputs (3-4, 5-6)

- Max. voltage U_{max} : 48V AC/DC
- Max. current I_{max} : 50 mA
- Max. output frequency f_{max} : 100 Hz
- Update interval: < 1s
- ON-resistance R_0 : $\leq 100\Omega$
- OFF-resistance R_∞ : $\geq 10M\Omega$
- Insulation voltage: > 100V AC/DC

Adjustable functions:

Volume pulses

- Pulse width t: 5, 50, 250, 500 ms
 Pulse value: parameterisable

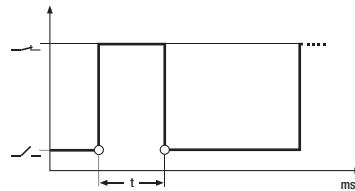

Current signal

- Flow rate at 4 mA Q_1 : parameterisable
- Flow rate 20 mA Q_2 : parameterisable
- Attenuation: parameterisable

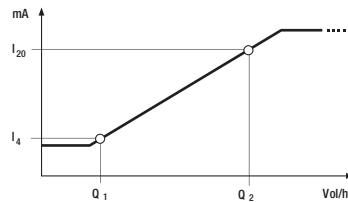

Frequency signal

- Output frequency f_{max} : 100Hz
 Pulse ratio: 1:1
 Frequency / Flowrate f_1/Q_1 : parameterisable
 Frequency / Flowrate f_2/Q_2 : parameterisable

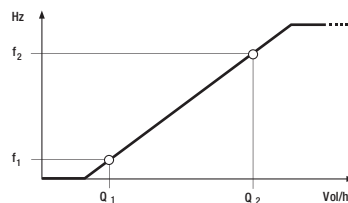

Limiting value switch

- Limit Q_{min} : parameterisable
 Limit Q_{max} : parameterisable
 Hysteresis H: parameterisable

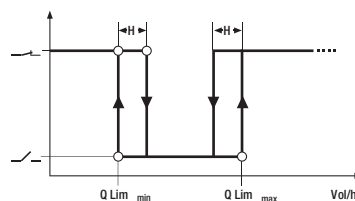

Dimensions

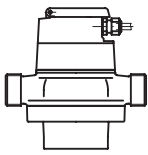
Type	mm	VZF 15	VZF 20	VZF 25	VZF 40	VZF 50
	Length	165	165	190	300	350
	Width	105	105	130	210	280
	Height	155	164	191	243	299

Detailed dimensional diagrams in "APPENDIX: Meter data"

Type designation key

VZF 25 FL 130/25

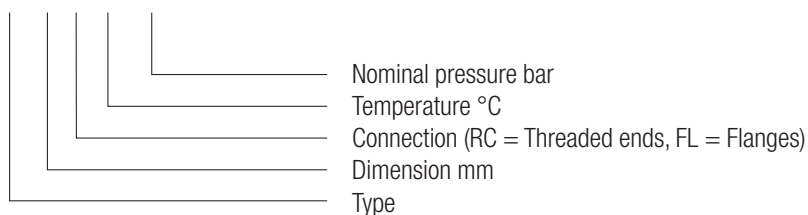

Ordering specifications

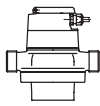
Threaded ends, PN16	Type 130 °C	Order No.
	VZF 15 RC 130/16	93705
	VZF 20 RC 130/16	93708
	VZF 25 RC 130/16	93725
	VZF 40 RC 130/16	93730

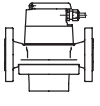
Flanges, PN25	Type 130 °C	Order No.	Type 180 °C	Order No.
		VZF 15 FL 130/25	93706	
VZF 20 FL 130/25		93709	VZF 20 FL 180/25	93710
VZF 25 FL 130/25		93726	VZF 25 FL 180/25	93727
VZF 40 FL 130/25		93731	VZF 40 FL 180/25	93732
VZF 50 FL 130/25		93735	VZF 50 FL 180/25	93736

Modification VZF	For marine type approval (e.g. GL, LRS, DNV)	96295
------------------	--	-------

CONTOIL® Classic VZO 4...50

VZO 4 and 8

Technical data 1)



- oil meter with internal threaded connections located on the bottom plate
- with mechanical roller counter, volume display in litres
- meters in US-Gallons 2)
- for mounting in horizontal, vertical and inclined positions
- VZO 4 and 8 with type approval / official verification

Option: Reed pulser 48 V

Type		VZO 4	VZO 4	VZO 8	
		Q_{min} 0.5			
Nominal diameter	mm	4	4	8	
	inch	1/8	1/8	1/4	
Connection threads of meter	inch	1/8	1/8	1/4	
Nominal pressure	bar	25			
Temperature	T _{max} ° C	60			
Maximum flow rate	Q _{max} 3)	l/h	40	80	200
Nominal flow rate	Q_n 3)	l/h	25	50	135
Minimal flow rate	Q _{min} 4)	l/h	0.5	1	4
Approx. starting flow rate		l/h	0.3	0.4	1.6
Max. permissible error			± 1% of actual value 4)		
Repeatability			± 0.2%		
Smallest readable amount	l	0.001	0.001	0.01	
Registration capacity	m ³	100	100	1000	
Registration at Q _n until overrunning to zero	h	4 000	2 000	7 400	
Safety filter mesh size	mm	0.125	0.125	0.150	
Dirt filter mesh size	mm	0.080	0.080	0.100	
Volume of the measuring chamber	approx. cm ³	5	5	12.5	
Weight without couplings	approx. kg	0.65	0.65	0.75	
Reed pulsers	RE 1	l/pulse	–	–	1
	RE 0.1		–	0.1	0.1
	RE 0.01		–	0.01	–
	RE 0.00125		–	0.00125	–
	RE 0.00311		–	–	0.00311
Pulse frequency for	RE 0.00125 5)	at Q _{max} Hz	–	17.777	–
		at Q _{min} Hz	–	0.222	–
Pulse frequency for	RE 0.00311 5)	at Q _{max} Hz	–	–	17.864
		at Q _{min} Hz	–	–	0.357

1) Manufacturer's specification, valid for the reference conditions as specified under "APPENDIX: Meter data".

2) 1 US gallon corresponds to 3.785 litres

3) For burners and engines or motors, the meter must be selected on the basis of the permanent flow rate. For higher viscosities, or if the meter is installed on the suction side, the pressure drop and any reduction in the measuring range must also be taken into consideration.

4) Max. permissible error: VZO 4 Q_{min} 0.5: 0.5 l/h ... 2 l/h = + 1% / - 2%. VZO 4: 1 l/h ... 2 l/h = + 1% / - 2%.

5) Note: pulses of short duration!

VZOA 4 and 8 with type approval

Technical data for VZOA with PTB type approval: 5.232 / 04.37 Class 1

Data according to type approval specifications			VZOA 4	VZOA 8
Temperature max.	T _{max}	° C	60	60
Maximum flow rate	Q _{max}	l/h	20	140
Nominal flow rate	Q_n	l/h	20	140
Minimal flow rate	Q _{min}	l/h	2	14
Max. permissible error		± % of actual value	0.5	0.5

Technical data for VZOA with type approval / EU official verification D 04/5.232.14

Data according to type approval specifications			VZOA 4	VZOA 8
Temperature max.	T_{max}	°C	50	50
Maximum flow rate	Q_{max}	l/h	20	140
Nominal flow rate	Q_n	l/h	20	140
Minimal flow rate	Q_{min}	l/h	2	14
Max. permissible error	± % of actual value		0.5	0.3

Two items are required when ordering: the VZOA meter and EU official verification, Order No. 96026.

Pressure drop curves

See "APPENDIX: Meter data"

Dimensions in mm

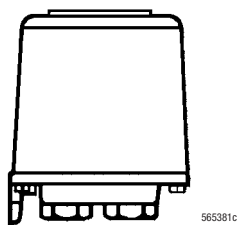

height = 79
width = 65
depth = 65

Dial

VZO 4

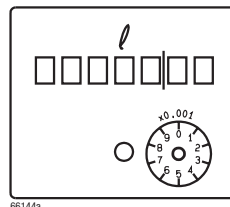

VZO 8

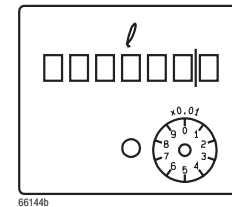

Detailed dimensional drawings in "APPENDIX: Meter data"

Mounting kit for VZO 8

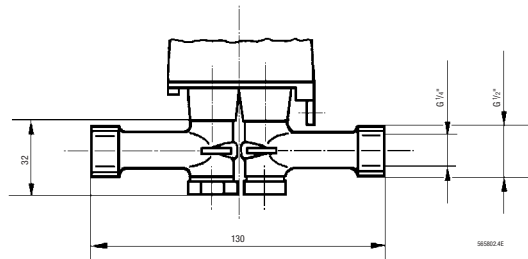

Order No. 81130: some possible mounting positions

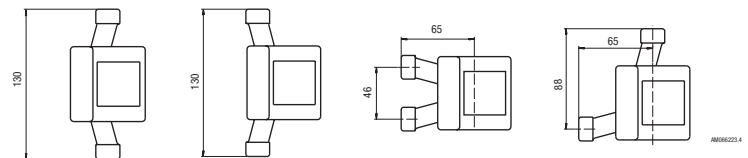

RE Pulsers

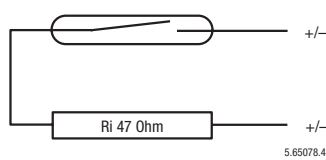

Switching element:
Switching voltage:
Switching current:
Quiescent current:
Switching power:
ON-time:

- Reed switch with dry contact (inert gas)
- Max. 48 V AC/DC
- Max. 50 mA
- Open Contact
- Max. 3 VA
- VZO 4-RE 0.00125: 65...90 %
- VZO 4-RE 0.01: 10...30 %
- VZO 4-RE 1: 30...70 %
- VZO 8-RE 0.00311: 65...90 %
- VZO 8-RE 0.1: 10...30 %
- VZO 8-RE 1: 30...70 %
- Ambient -10 ... +60 °C
- Meters without pulser:
 - IP 65 (IEC 60529) against water-jets and dust
- Meters with pulser RE:
 - IP 50 (IEC 60529) against dust deposits
 - On plug supplied with product for cable, 2 × 0.35 mm²

Temperature:
Protection class:

Connections:

Ordering specifications

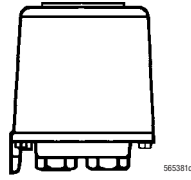
	Type	Order No.	Type	Order No.
	VZO 4	92680	VZO 8	92630
	VZO 4 RE 0.00125	89763	VZO 8 RE 0.00311	89733
	VZO 4 RE 0.01	89760	VZO 8 RE 0.1	89730
	VZO 4 RE 0.1	89761	VZO 8 RE 1	89731
	VZO 4 Q _{min} 0.5	92678		
	VZO A 4	93162	VZO A 8	93163

Modifications / Options

Modification	with EC official verification	96026
--------------	-------------------------------	-------

Special versions with FMP fluoroelastomer gaskets

VZO 4 V	Order No. 92487
VZO 4 V - RE 0.01	Order No. 92488
VZO 4 V - RE 0.1	Order No. 92489

VZO 4 and 8 OEM

Technical data 1)

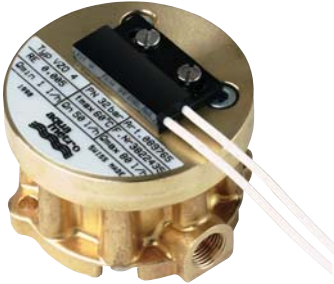

- fuel oil meters for OEMs (original equipment manufacturers), to be mounted under the burner cover
- meters with lateral internal threaded connections
- with 230V Reed pulser to display measurement values on remote totaliser or on burner control unit
- for mounting in horizontal, vertical or inclined positions

Type		VZO 4 OEM	VZO 8 OEM	
Nominal diameter	mm	4	8	
	inch	1/8	1/4	
Connection threads of meter	inch	1/8	1/4	
Nominal pressure	bar	32	25	
Temperature	T _{max} °C	60	60	
Maximum flow rate	Q _{max} ²⁾ l/h	80	200	
Nominal flow rate	Q_n²⁾ l/h	50	135	
Minimal flow rate	Q _{min} ³⁾ l/h	1	4	
Approx. starting flow rate	l/h	0.4	1.6	
Max. permissible error		± 1% of actual value ³⁾		
Repeatability		± 0.2%		
Safety filter mesh size	mm	-	0.150	
Dirt filter mesh size	mm	0.080	0.100	
Volume of the measuring chamber	approx. cm ³	5	12.5	
Weight	approx. kg	0.65	0.75	
Reed pulsers	RE	l/pulse	0.005	0.0125
Pulse frequency	at Q _{max}	Hz	4.444	4.444
	at Q _{min}	Hz	0.056	0.089

1) Manufacturer's specification, valid for the reference conditions as specified under "APPENDIX: Meter data".

2) For burners and engines or motors, the meter must be selected on the basis of the permanent flow rate. For higher viscosities, or if the meter is installed on the suction side, the pressure drop and any reduction in the measuring range must also be taken into consideration.

3) Max. permissible error: VZO 4 OEM: 1 l/h ... 2 l/h = + 1%/- 2%.

Safety precaution

When connecting the Reed pulser to a low-voltage power source (50...250 V AC/DC), the specialist installing the equipment is responsible for ensuring that all local regulations are observed (e.g. regulations for electrical installations, personnel safety).

Pressure drop curves

See "APPENDIX: Meter data"

Dimensions in mm

VZO 4 OEM

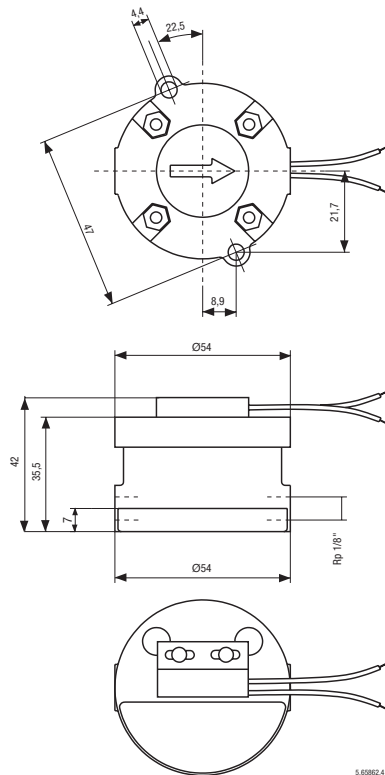

VZO 8 OEM

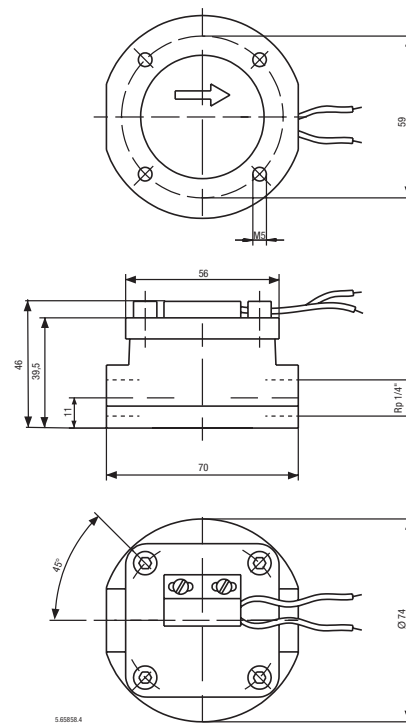

RE Pulsers

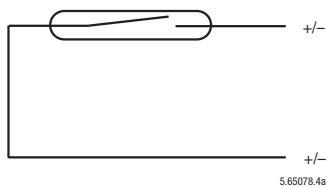

Switching element:
Switching voltage:
Switching current:
Quiescent current:
Switching power:
ON-time:
Temperature:
Protection class:
Connections:

- Reed switch with dry contact (inert gas)
- max. 230 V AC/DC
- max. 50 mA
- Open Contact
- max. 3 VA
- 40 ... 55%
- Ambient -10 ... +60°C
- IP 65 (IEC 60529) against water-jets and dust
- Cable cross section $2 \times 0.5 \text{ mm}^2$, length 480 mm

Remote totaliser for VZO 4 OEM



Power supply:
Pulse value (input):
Smallest readable amount:
Registration capacity:
Registration:
Panel cut-out:
Installation depth:

- 230 V, 50/60 Hz
- 0.005 l
- 0.005 l
- 10 000 l
- at Q_n before return to zero 200 h
- $27 \times 14.4 - 0/+ 0.2 \text{ mm}$
- 56 mm

Ordering specifications

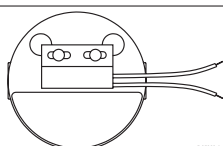
	Type	Description	Order No.
	VZO 4 OEM-RE 0.005	Version for OEMs	89765
		Remote totaliser for VZO 4 OEM	93349
	VZO 8 OEM-RE 0.0125	Version for OEMs	89771

VZO 15 ... 50

Technical data ¹⁾



- Volume display on roller counter, in litres
- fuel oil meter with threaded or flanged ends
- for horizontal, vertical or inclined mounting

Option: Reed pulser or RV / IN pulser

Versions available on request:

- different flange drillings, such as ANSI, JIS
- meters in US gallons ²⁾ (option)

Type			VZO 15	VZO 20	VZO 25	VZO 40	VZO 50
Nominal diameter	DN	mm	15	20	25	40	50
		inch	1/2	3/4	1	1 1/2	2
Installation length		mm	165	165	190	300	350
Nominal pressure with threaded ends with flanges	PN	bar	16				
	PN	bar	25, 40				
Maximum temperature	T _{max}	°C	130, 180				
Maximum flow rate	Q _{max} ³⁾	l/h	600	1500	3000	9000	30000
Nominal flow rate	Q_n ³⁾	l/h	400	1000	2000	6000	20000
Minimal flow rate	Q _{min}	l/h	10	30	75	225	750
Approx. starting flow rate		l/h	4	12	30	90	300
Max. permissible error			± 1% of actual value				
Repeatability			± 0.2%				
Safety filter mesh size		mm	0.400	0.400	0.400	0.800	0.800
Dirt filter mesh size		mm	0.250	0.400	0.400	0.600	0.600
Volume of the measuring chamber		approx. cm ³	12	36	100	330	1200
Housing finish			enamelled red RAL 3013				
Weight with threaded ends ⁴⁾		approx. kg	2.2	2.5	4.2	17.3	–
	with flanges PN 25	approx. kg	3.8	4.5	7.5	20.3	41.0
	with flanges PN 40	approx. kg	4.4	5.5	7.8	20.5	42.0
Smallest readable amount		l	0.01	0.1	0.1	0.1	1
Registration capacity		m ³	1000	10000	10000	10000	100000
Registration time at Q _n until overrunning to zero		h	2500	10000	5000	1667	5000
Pulse values of pulsers:							
IN inductive according to IEC 60947-5-6		l/pulse	0.01	0.01	0.1	0.1	1
RV Reed		l/pulse	0.1	1	1	1	10
RV Reed		l/pulse	1	–	–	10	100
Pulse frequency IN	at Q _{max}	Hz	16.667	41.667	8.333	25.000	8.333
	at Q _{min}	Hz	0.278	0.833	0.208	0.625	0.208

1) Manufacturer's specification, valid for the reference conditions as specified under "APPENDIX: Meter data".

2) 1 US gallon corresponds to 3.785 litres

3) For burners and engines or motors, the meter must be selected on the basis of the permanent flow rate. For higher viscosities, or if the meter is installed on the suction side, the pressure drop and any reduction in the measuring range must also be taken into consideration.

4) Weight without couplings.

Pressure drop curves

See "APPENDIX: Meter data"

Dimensions

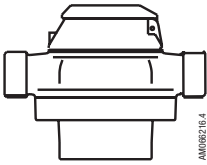
Type	mm	VZO 15	VZO 20	VZO 25	VZO 40	VZO 50	
	Length	165	165	190	300	350	
	Width	105	105	130	210	280	
	Typ ... 130 °C						
	Height	106	115	142	235	291	
	Height -RV	130	139	166	259	315	
	Height -IN	185	194	221	273	329	
	Typ ... 180 °C						
	Height	147	156	183	235	291	
	Height -RV	171	180	207	259	315	
	Height -IN	225	234	261	313	369	

Detailed dimensional diagrams in "APPENDIX: Meter data".

RV Pulsers

This type of pulser is integrated into the roller counter and thus is especially appropriate for remote totalisation. For other applications the IN inductive pulser is preferable.

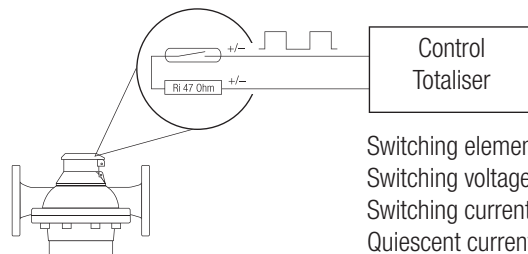

Switching element:
Switching voltage:
Switching current:
Quiescent current:
Switching power:
ON-time:
Temperature:
Protection class:
Connections:
Cable cross section:

- Reed switch with dry contact (inert gas)
- max. 48 V AC/DC
- max. 50 mA (Ri = 47 Ω/0.5 W)
- Open Contact
- max. 2 W
- 50% ± 10%
- Ambient -10 ... +70° C
- IP 65 (IEC 60529) against water-jets and dust
- Cast-in cable, length 3 m
- 2 x 0.14 mm²

IN Pulsers

Pulser for industrial applications. Supplied with plug-in pulser sensor.

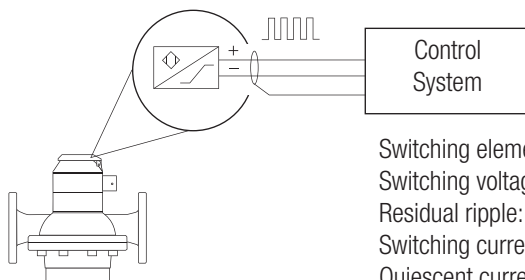

Switching element:
Switching voltage:
Residual ripple:
Switching current:
Quiescent current:
ON-time:
Temperature:
Protection class:
Connections:

- Inductiv slot initiator according to IEC 60947-5-6
- 5 ... 15 V DC
- max. 5%
- > 3 mA at 8 V DC / 1 kΩ
- < 1 mA at 8 V DC / 1 kΩ
- 50% ± 10%
- Ambient -10 ... +70° C
- IP 65 (IEC 60529) against water-jets and dust
- Pulser supplied with special plug. Required cable min. 2 x 0.35 mm² and 4...6 mm external diameter or the cable is already mounted if the option "Order No. 80019" is chosen.
- Cable mounted, 2 x 0.5 mm², PVC black, length 3 m (Order No. 80019)

Option:

Type designation key

VZO 25 FL 130/25-IN 0.1

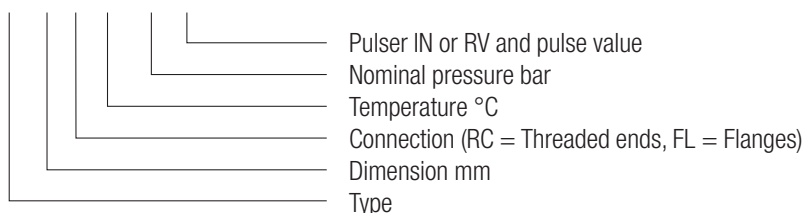

Ordering specifications

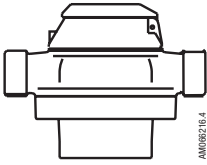
Threaded ends, PN16	Type 130 °C	Order No.	Type 130 °C	Order No.
		VZO 15 RC 130/16	92041	VZO 25 RC 130/16
VZO 15 RC 130/16-RV 0.1		92042	VZO 25 RC 130/16-RV 1	92058
VZO 15 RC 130/16-RV 1		92043	VZO 25 RC 130/16-IN 0.1	91913
VZO 15 RC 130/16-IN 0.01		91900		
VZO 20 RC 130/16		92047	VZO 40 RC 130/16	92004
VZO 20 RC 130/16-RV 1		92048	VZO 40 RC 130/16-RV 1	92018
VZO 20 RC 130/16-IN 0.01		91902	VZO 40 RC 130/16-IN 0.1	91906

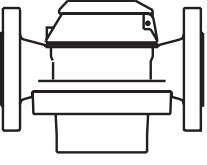
Flanges, PN25	Type 130 °C	Order No.	Type 130 °C	Order No.
		VZO 15 FL 130/25	92044	VZO 40 FL 130/25
VZO 15 FL 130/25-RV 0.1		92045	VZO 40 FL 130/25-RV 1	92020
VZO 15 FL 130/25-RV 1		92046	VZO 40 FL 130/25-IN 0.1	91907
VZO 15 FL 130/25-IN 0.01		91910		
VZO 20 FL 130/25		92049	VZO 50 FL 130/25	92007
VZO 20 FL 130/25-RV 1		92050	VZO 50 FL 130/25-RV 10	92024
VZO 20 FL 130/25-IN 0.01		91903	VZO 50 FL 130/25-IN 1	91909
VZO 25 FL 130/25		92059		
VZO 25 FL 130/25-RV 1		92060		
VZO 25 FL 130/25-IN 0.1		91914		

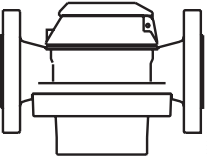
Flanges, PN25	Type 180 °C	Order No.	Type 180 °C	Order No.
		VZO 15 FL 180/25	92250	VZO 40 FL 180/25
VZO 15 FL 180/25-RV 0.1		92251	VZO 40 FL 180/25-RV 1	92275
VZO 15 FL 180/25-RV 1		92252	VZO 40 FL 180/25-IN 0.1	92276
VZO 15 FL 180/25-IN 0.01		92253		
VZO 20 FL 180/25		92258	VZO 50 FL 180/25	92280
VZO 20 FL 180/25-RV 1		92259	VZO 50 FL 180/25-RV 10	92281
VZO 20 FL 180/25-IN 0.01		92260	VZO 50 FL 180/25-IN 1	92282
VZO 25 FL 180/25		92264		
VZO 25 FL 180/25-RV 1		92265		
VZO 25 FL 180/25-IN 0.1		92266		

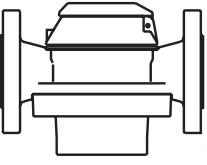
Flanges, PN40	Type 180 °C	Order No.	Type 180 °C	Order No.
		VZO 15 FL 180/40	92254	VZO 40 FL 180/40
VZO 15 FL 180/40-RV 0.1		92255	VZO 40 FL 180/40-RV 1	92278
VZO 15 FL 180/40-RV 1		92256	VZO 40 FL 180/40-IN 0.1	92279
VZO 15 FL 180/40-IN 0.01		92257		
VZO 20 FL 180/40		92261	VZO 50 FL 180/40	92283
VZO 20 FL 180/40-RV 1		92262	VZO 50 FL 180/40-RV 10	92284
VZO 20 FL 180/40-IN 0.01		92263	VZO 50 FL 180/40-IN 1	92285
VZO 25 FL 180/40		92267		
VZO 25 FL 180/40-RV 1		92268		
VZO 25 FL 180/40-IN 0.1		92269		

DN 15 only when the plant has a dirt filter with a max. 0.1 mm mesh size.

Modification VZO	For marine type approval (e.g. GL, LRS, DNV)	96295
Option / Accessory	Cable mounted on IN	80019

CONTOIL® VZFA/VZOA 15...50, versions for special requirements / applications

For applications requiring an increased accuracy of $\pm 0.5\%$ or better, such as:

- Measurement of EL heating fuel or diesel in testing facilities
- Differential measurement
- Commercial transactions for which the meters are legally required to have type approval or official verification.

These products require dirt filters with smaller mesh size.

Versions for differential measurements

For differential measurements, the flow is measured in the supply and return pipes. The difference between the two measurements is regarded as the consumption.

To obtain optimal measurement results, VZFA or VZOA CONTOIL® fuel oil meters calibrated in pairs should only be used, which are adapted precisely to the plant/system operating conditions. The flow rate occurring in each meter, the permissible pressure drop and the viscosity of the fluid must all be considered during the design phase. The load on the meter is obtained as follows: flow in supply section less consumption = flow in return section.

When the order is placed, the following information is required:

- application e.g. differential measurement for diesel engines in an emergency power system
- fuel type e.g. diesel fuel
- temperature e.g. 15 ... 40° C
- operating pressure e.g. 4 bar
- flow rate in supply section e.g. fixed pumping rate 200 l/h
- flow rate in return section e.g. 120 ... 190 l/h (for a consumption of 10 ... 80 l/h)

The meters are marked "supply" and "return" during calibration and final testing in the factory. They must then be installed in the correct pipes.

For further information on the subject of differential measurement, see the sections "How to obtain an optimal measurement" and "Application examples".

Versions with type approval or official verification

CONTOIL® fuel oil meters are used almost exclusively for the measurement of the consumption of fuel oil. The metrological standards (such as MID or EC guideline 71/319/EEC), however, regulate the requirements for meters and systems used for commercial transactions as well as the procedures for design approval and official verification. Measuring installations where a fluid is sold are regarded as transfer points that require official verification. These include petrol pumps at petrol stations, measuring devices for road tankers and measuring stations for loading and unloading all types of road vehicles. As a rule, a metering system must be ready for use and be checked and sealed by the local office responsible for transfer verification.

Typical of these applications is the narrow range of use with regard to liquid, flow rate and temperature. Subject to type approval restrictions, CONTOIL® oil meters are also available with metrological type approval or official verification. The differences in products relate only to the design or specifications of the meter and not to the quality of the product.

Technical data ¹⁾



- Versions for optimal results from differential measurement or for fiscal or commercial transactions
- VZFA with electronic display of total volume, resettable volume and flow rate; units of measurement: litres, US gallons ²⁾ or m³.
- VZOA with display of total volume on roller counter; units of measurement: litres. Optional versions with counter in US gallons.
- VZOA option: with RV reed or IN inductive pulser
- threaded or flanged connections available
- mounting in horizontal or vertical positions possible (for calibrated meters horizontally only).
- VZFA: User-friendly, interactive parameter input. Easy integration into control systems.

Further Versions available on request:

- different flange drillings, such as ANSI, JIS

Type	VZFA/VZOA						
Nominal diameter	DN	mm	15	20	25	40	50
		inch	1/2	3/4	1	1 1/2	2
Installation length		mm	165	165	190	300	350
Nominal pressure with threaded ends	PN	bar	16				
with flanges	PN	bar	25				
Maximum temperature	T _{max}	°C	130, 180				
Maximum flow rate	Q _{max} ³⁾	l/h	600	1500	3000	9000	30000
Nominal flow rate	Q_n ³⁾	l/h	400	1000	2000	6000	20000
Minimal flow rate	Q _{min}	l/h	10	30	75	225	750
Approx. starting flow rate		l/h	4	12	30	90	300
Max. permissible error			< 0.5% of actual value				
Repeatability			± 0.1%				
Safety filter mesh size		mm	0.400	0.400	0.400	0.800	0.800
Dirt filter mesh size		mm	0.100	0.100	0.250	0.250	0.250
Volume of the measuring chamber		approx. cm ³	12	36	100	330	1200
Housing finish			enamelled red RAL 3013				
Weight with threaded ends ⁴⁾		approx. kg	2.2	2.5	4.2	17.3	–
with flanges PN 25		approx. kg	3.8	4.5	7.5	20.3	41.0
VZFA							
Smallest readable amount:							
Total volume		l	No decimals				
Resettable volume		l	1 decimal place				
Digital flow rate display		l/h	1 decimal place				
Registration capacity		l	100 000 000				
Registration time at Q _n until overrunning to zero		h	128 000	100 000	50 000	16 667	5 000
Outputs ⁵⁾							
Pulse value for totaliser	V/Imp		pulse value and width parameterisable				
Current 4..20 mA for flow rate	I ₄ / Q ₁ , I ₂₀ / Q ₂		flow rates to 4 and 20 mA parameterisable				
Frequency for flow rate	f ₁ / Q ₁ , f ₂ / Q ₂		frequency and flowrate parameterisable				
Limiting value switch	Q _{min} , Q _{max}		minimum, maximum and hysteresis parameterisable				
VZOA							
Smallest readable amount		l	0.01	0.1	0.1	0.1	1
Registration capacity		m ³	1000	10 000	10 000	10 000	100 000
Registration time at Q _n until overrunning to zero		h	2 500	10 000	5 000	1 667	5 000
Pulse values of pulsers:							
IN inductive according to IEC 60947-5-6		l/pulse	0.01	0.01	0.1	0.1	1
RV Reed		l/pulse	0.1	1	1	1	10
RV Reed		l/pulse	1	–	–	10	100

1) Manufacturer's specification, valid for the reference conditions as specified under "APPENDIX: Meter data".

2) 1 US gallon corresponds to 3.785 litres

3) For burners and engines or motors, the meter must be selected on the basis of the permanent flow rate. For higher viscosities, or if the meter is installed on the suction side, the pressure drop and any reduction in the measuring range must also be taken into consideration.

4) Weight without couplings.

5) Two freely selectable outputs are available, totally independent of each other.

Technical data for VZOA with PTB certification: 5.232 / 04.37 Class 1

Type			VZOA 15	VZOA 20	VZOA 25	VZOA 40	VZOA 50
Temperature max.	T_{max}	°C	130				
Maximum flow rate	Q_{max} 1)	l/h	400	1000	2000	6000	20000
Nominal flow rate	Q_n 1)	l/h	400	1000	2000	6000	20000
Minimal flow rate	Q_{min}	l/h	40	100	200	600	2000
Accuracy class				1	1	1	1 1
Max. permissible error	± % of actual value		0.5	0.5	0.5	0.5	0.5

Technical data for VZOA with type approval / EC verification: D 04 / 5.232.14

Type			VZOA 15	VZOA 20	VZOA 25	VZOA 40	VZOA 50
Temperature max.	T_{max}	°C	50				
Maximum flow rate	Q_{max} 1)	l/h	400	1000	2000	6000	20000
Nominal flow rate	Q_n 1)	l/h	400	1000	2000	6000	20000
Minimal flow rate	Q_{min}	l/h	40	100	200	600	2000
Accuracy class			0.5	0.5	0.5	0.5	0.5
Max. permissible error	± % of actual value		0.3	0.3	0.3	0.3	0.3

Two items are required when ordering: the VZOA meter and EU verification, Order No. 96026.

1) For burners and engines or motors, the meter must be selected on the basis of the permanent flow rate. For higher viscosities, or if the meter is installed on the suction side, the pressure drop and any reduction in the measuring range must also be taken into consideration.

Electronic display and Outputs VZFA

Please refer to Electronic display and Outputs of VZF on pages 6 and 7.

RV Pulsers and IN Pulsers VZOA

Please refer to RV Pulsers and IN Pulsers of VZF on page 15.

Pressure drop curves

See "APPENDIX: Meter data"

Dimensions VZFA

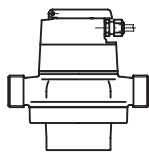
Type	mm	VZFA 15	VZFA 20	VZFA 25	VZFA 40	VZFA 50
	Length	165	165	190	300	350
	Width	105	105	130	210	280
	Height	155	164	191	243	299

Dimensions VZOA

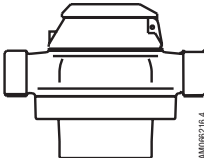
Type	mm	VZOA 15	VZOA 20	VZOA 25	VZOA 40	VZOA 50
	Length	165	165	190	300	350
	Width	105	105	130	210	280
	Typ ... 130 °C					
	Height	106	115	142	235	291
	Height -RV	130	139	166	259	315
	Height -IN	185	194	221	273	329
	Typ ... 180 °C					
	Height	147	156	183	235	291
	Height -RV	171	180	207	259	315
	Height -IN	225	234	261	313	369

Detailed dimensional diagrams in "APPENDIX: Meter data"

Type designation key

VZOA 25 FL 130/25-IN 0.1

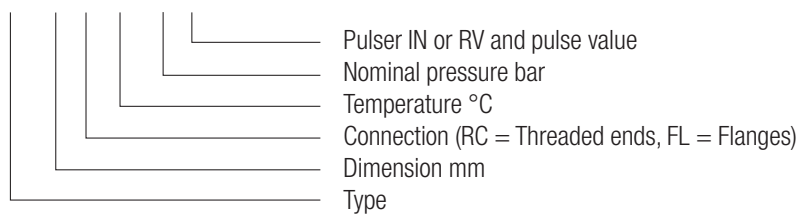

Information required to process orders

When the order is placed, information is required on the plant operating conditions (as stated at the beginning of this section). For fiscal and commercial transactions only VZOA type meters may be used.

Example for differential measurement:

Application: Differential measurement diesel, supply 200 l/h, return 120. ... 190 l/h
 2 Units Order No. 93758 CONTOIL® fuel oil meter, type VZFA 20 RC 130/16
 2 Units Order No. 96112 Modification for differential measurement

Example for fiscal or commercial transactions:

Application: Commercial transactions in Germany, extra light heating oil, flow rate 200...400 l/h, temperature approximately 20 °C
 1 Unit Order No. 92290 CONTOIL®, fuel oil meter, type VZOA 20 RC 130/16
 1 Unit Order No. 96026 Modification with EC official verification

Example for standard applications without options:

Application: Measurement of Diesel fuel on testing facility, flow rate 200...400 l/h, temperature 20...50 °C
 1 Unit Order No. 93758 CONTOIL®, fuel oil meter, type VZFA 20 RC 130/16

Ordering details for VZFA (meters with electronic counters and parameterisable outputs)

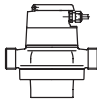
Threaded ends, PN16	Type 130 °C	Order No.	
	VZFA 15 RC 130/16	93755	
	VZFA 20 RC 130/16	93758	
	VZFA 25 RC 130/16	93763	
	VZFA 40 RC 130/16	93768	

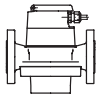
Flanges, PN25	Type 130 °C	Order No.	Type 180 °C	Order No.
	VZFA 15 FL 130/25	93756	VZFA 15 FL 180/25	93757
	VZFA 20 FL 130/25	93759	VZFA 20 FL 180/25	93760
	VZFA 25 FL 130/25	93764	VZFA 25 FL 180/25	93765
	VZFA 40 FL 130/25	93769	VZFA 40 FL 180/25	93770
	VZFA 50 FL 130/25	93773	VZFA 50 FL 180/25	93774

Modifications		Order No.
	For differential measurement	96112
	For marine type approval (e.g. GL, LRS, DNV)	96295

Ordering details for VZOA (meter with roller counter)

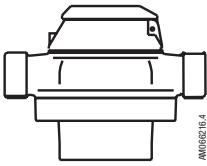
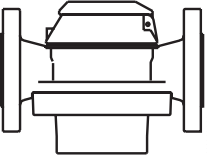
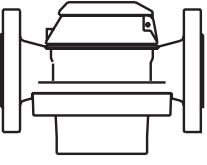
Threaded ends, PN16	Type 130° C	Order No.	Type 130° C	Order No.
	VZOA 15 RC 130/16	92286	VZOA 25 RC 130/16	92293
	VZOA 15 RC 130/16-RV 0.1	92287	VZOA 25 RC 130/16-RV 1	92294
	VZOA 15 RC 130/16-RV 1	92288	VZOA 25 RC 130/16-IN 0.1	92295
	VZOA 15 RC 130/16-IN 0.01	92289		
	VZOA 20 RC 130/16	92290	VZOA 40 RC 130/16	92296
	VZOA 20 RC 130/16-RV 1	92291	VZOA 40 RC 130/16-RV 1	92297
	VZOA 20 RC 130/16-IN 0.01	92292	VZOA 40 RC 130/16-IN 0.1	92298
Flanges, PN25	Type 130° C	Order No.	Type 130° C	Order No.
	VZOA 15 FL 130/25	92299	VZOA 40 FL 130/25	92309
	VZOA 15 FL 130/25-RV 0.1	92300	VZOA 40 FL 130/25-RV 1	92310
	VZOA 15 FL 130/25-RV 1	92301	VZOA 40 FL 130/25-IN 0.1	92311
	VZOA 15 FL 130/25-IN 0.01	92302		
	VZOA 20 FL 130/25	92303	VZOA 50 FL 130/25	92312
	VZOA 20 FL 130/25-RV 1	92304	VZOA 50 FL 130/25-RV 10	92313
	VZOA 20 FL 130/25-IN 0.01	92305	VZOA 50 FL 130/25-IN 1	92314
	VZOA 25 FL 130/25	92306		
	VZOA 25 FL 130/25-RV 1	92307		
	VZOA 25 FL 130/25-IN 0.1	92308		
Flanges, PN25	Type 180° C	Order No.	Type 180° C	Order No.
	VZOA 15 FL 180/25	92315	VZOA 40 FL 180/25	92325
	VZOA 15 FL 180/25-RV 0.1	92316	VZOA 40 FL 180/25-RV 1	92326
	VZOA 15 FL 180/25-RV 1	92317	VZOA 40 FL 180/25-IN 0.1	92327
	VZOA 15 FL 180/25-IN 0.01	92318		
	VZOA 20 FL 180/25	92319	VZOA 50 FL 180/25	92328
	VZOA 20 FL 180/25-RV 1	92320	VZOA 50 FL 180/25-RV 10	92329
	VZOA 20 FL 180/25-IN 0.01	92321	VZOA 50 FL 180/25-IN 1	92330
	VZOA 25 FL 180/25	92322		
	VZOA 25 FL 180/25-RV 1	92323		
	VZOA 25 FL 180/25-IN 0.1	92324		
Modifications	For differential measurement		96112	
	For marine type approval (e.g. GL, LRS, DNV)		96295	
	With EC official verification		96026	
Option / Accessory	Cable mounted on IN		80019	

Accessories

Ordering details for accessories

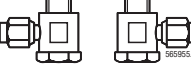
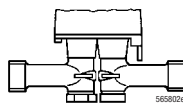
	Type	Description	Order No.
	VSR 1/2"	for DN 15	81160
	VSR 3/4" x 1/2"	for DN 20	81163
	VSR 3/4"	for DN 20	81166
	VSR 1"	for DN 25	81169
	VSR 1 1/2"	for DN 40	81181
Threaded connections kit	PS-Kit VZO 4	1/8" – 8	81583
	PS-Kit VZO 8	Mounting Kit	81130
	VSR 3/8"	Threaded connections to suit PS-Kit VZO 8	81156
			

Order details for supplementary equipment

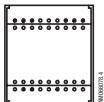
	Type	Description	Order No.
Remote totaliser	Pulse counter	Pulse counter, with or without zeroing, adjustable	93374
			
Isolated switch amplifier	Ex version	with relay output, max. 10 Hz	81705
	Ex version	with electronic output, max. 5 kHz	80013
			

Order details for supplementary equipment with mounting kits

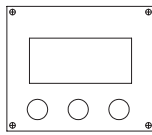
	Type	Description	Order No.
	Flow calculator	freely programmable, with analogue output 4...20 mA, indication of flow rate, limiting values	92439
	Differential flow calculator	freely programmable, with analogue output 4...20 mA, indication of flow rate, limiting values. Both inputs can be read out individually.	92440
	Frequency current converter	freely programmable.	92439
Mounting kit	Kit	for wall mounting or on DIN-35 mm rail	on request

Meter data

Function

CONTOIL® flow meters work on the volumetric principle of rotary piston meters (positive displacement meters). The main features of this measuring principle are large measuring ranges, high accuracy, suitability for high viscosities and independence from power supply; flow disturbances do not influence proper operation.



Construction

Rotary piston, guide roller and drive are the only moving parts in contact with the liquid. Their movement is transmitted by a magnetic coupling through a sealing plate. The hydraulic part is completely separated from the totalising module.

VZF/VZFA 15 ... 50

Connections are made radially with two cable entries underneath the through 360° in steps of 90°.



VZO/VZOA 15 ... 50

With the exception of the counter with the RV Reed pulser, the roller counter can be turned through 360° for optimum readability.



VZO/VZOA 4 and 8

The connections for the inlet and outlet base plate. With the OEM version the connections are situated on the side.



Measuring error limits: Reference conditions

Measuring error limits according to technical data of meter in % of actual value for the whole measuring range.

Reference conditions

- Liquid: Calibration oil similar to extra light heating oil, density at 20° C = 814 kg/m³
Viscosity = 5.0 mm²/s according to DIN 51757 / ISO 3104 (corresponds to 4.1 mPa.s)
- Temperature: 18 ... 25° C
- Horizontal mounting, readings from counter.
- CONTOIL® Oil meters are never to be tested with water, otherwise they will get damaged.

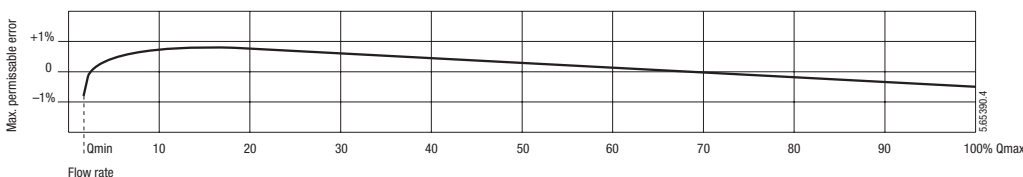

Pressure drop curves

Viscosity information

Kinematic viscosity
Dynamic viscosity

Stokes, Centi-Stokes, mm²/s
Pascal seconds, millipascal seconds
Poise, Centipoise (outmoded)

St, cSt, mm²/s
Pas, mPa.s
P, cP

Conversion

cSt × density = mPa.s
Engler degrees °E to mPa.s: only use conversion table
Saybold units to mPa.s: only use conversion table
Redwood units to mPa.s: only use conversion table

Rule of thumb

1 cSt → 1 mm²/s → 1 mPa.s

DN 4

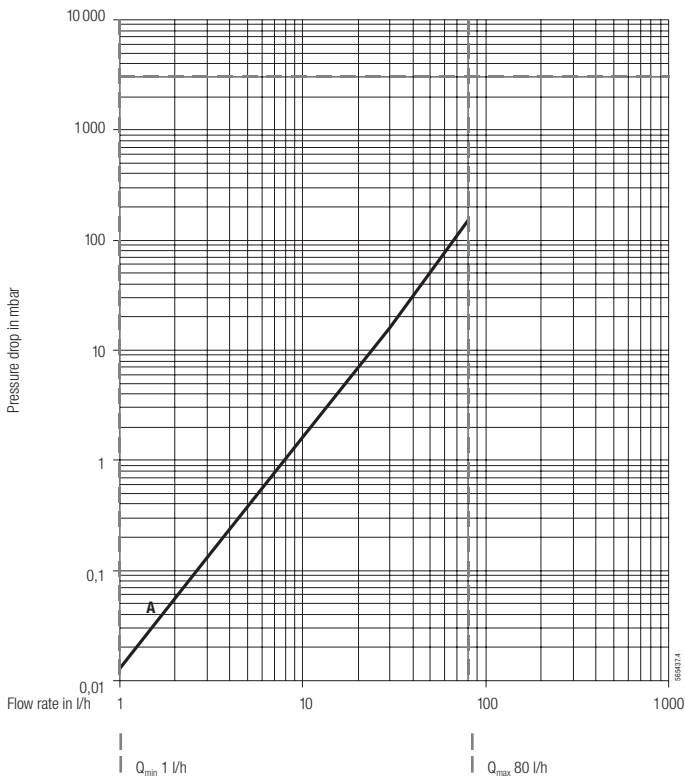

DN 8

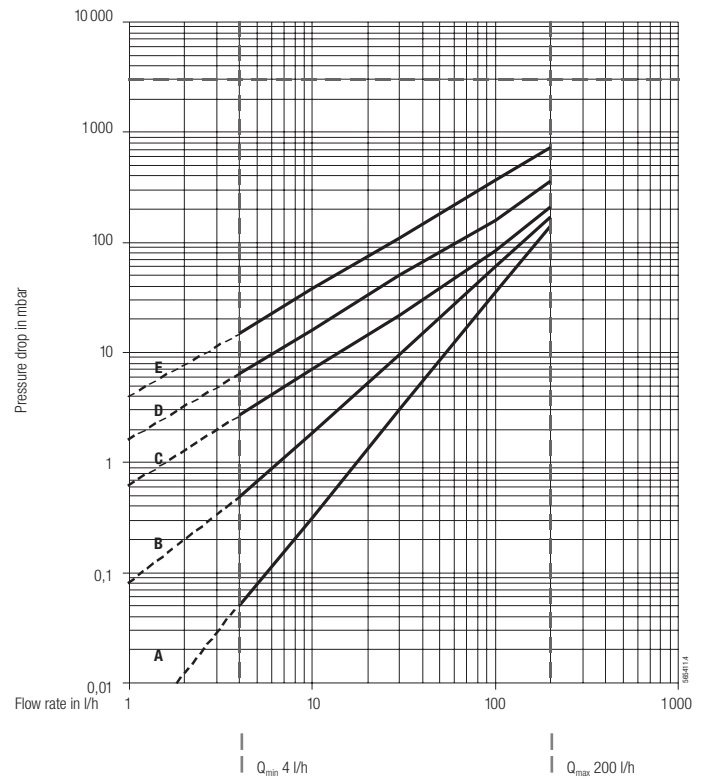

Viscosity diagrams:

A = 5 mPa.s
B = 50 mPa.s

C = 100 mPa.s
D = 200 mPa.s

E = 500 mPa.s

For a pressure drop of more than 1 bar, it is recommended to use the next larger meter size.
Maximum permissible pressure drop = 3 bar

DN 15

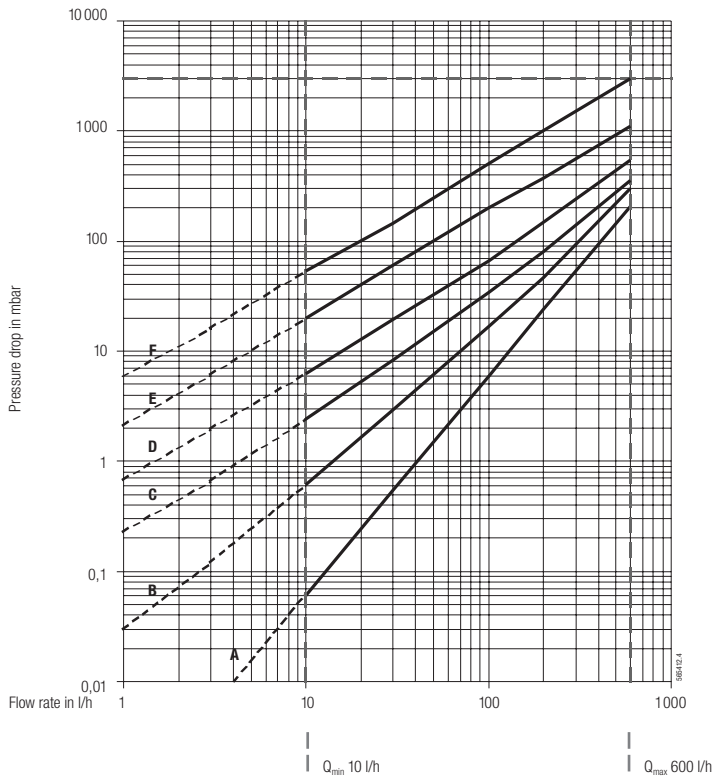

DN 20

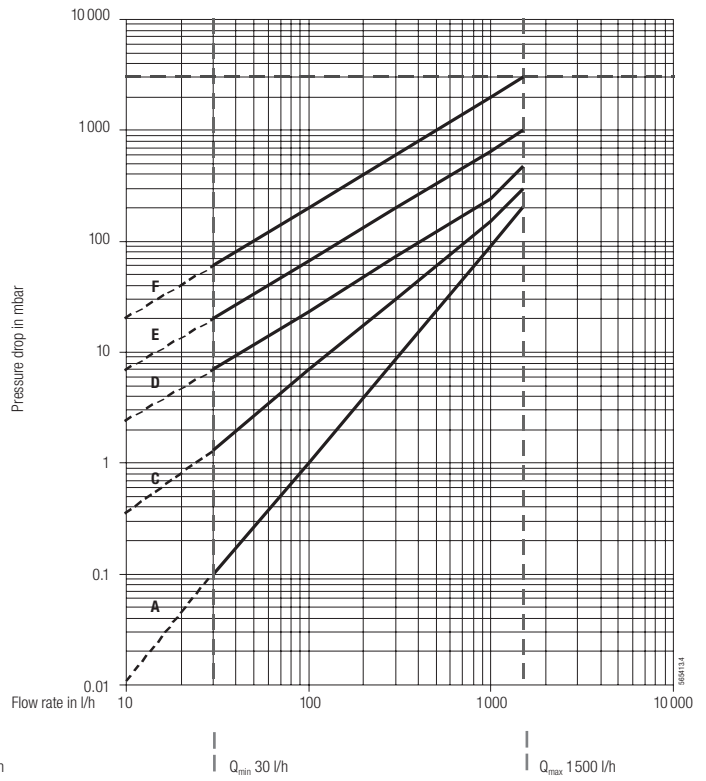

DN 25

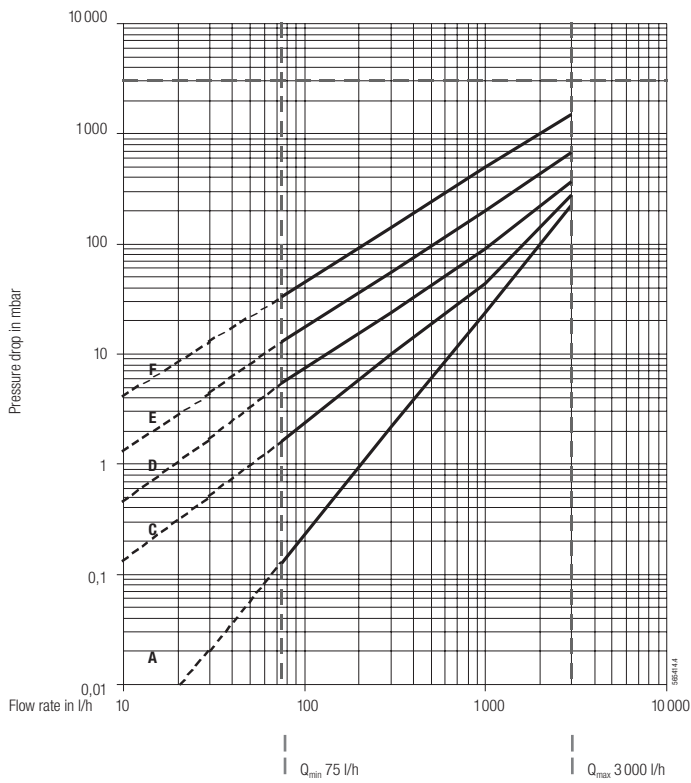

DN 40

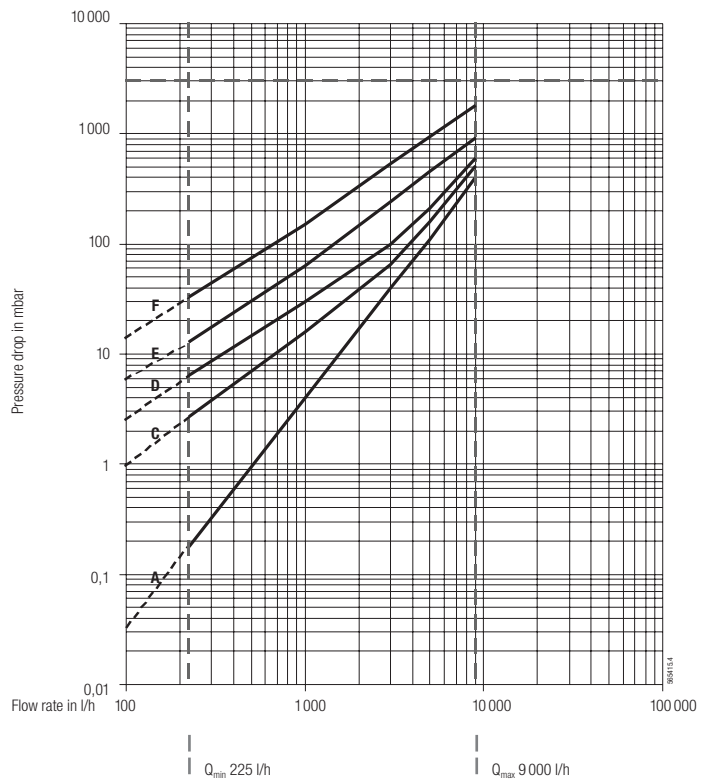

Viscosity diagrams:

A = 5 mPa.s
B = 25 mPa.s

C = 50 mPa.s
D = 100 mPa.s

E = 200 mPa.s
F = 500 mPa.s

For a pressure drop of more than 1 bar, it is recommended to use the next larger meter size.
Maximum permissible pressure drop = 3 bar

DN 50

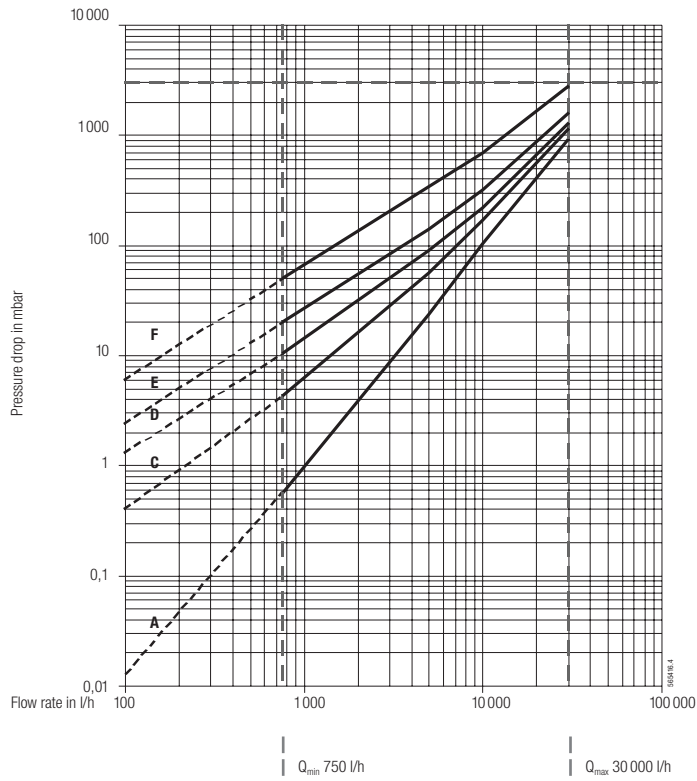

Example

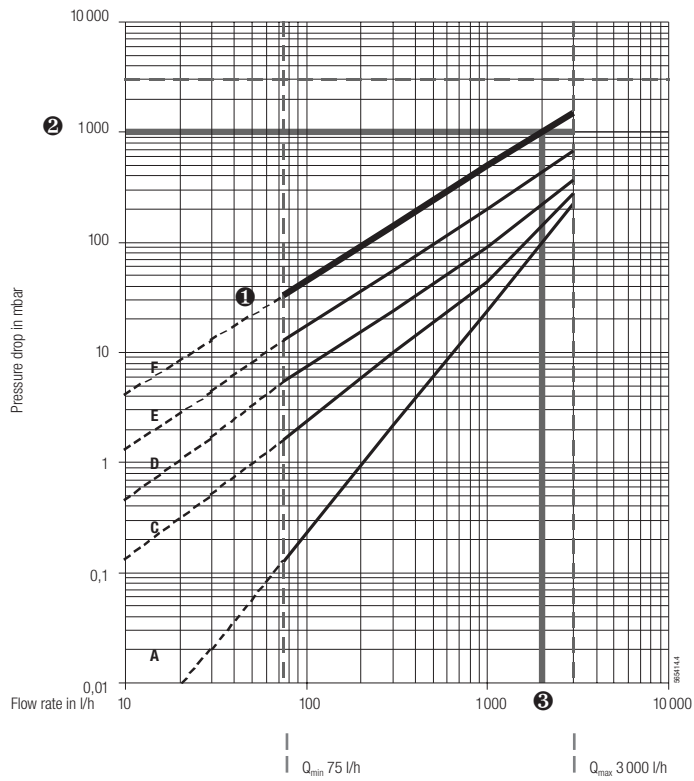

Mineral oil, viscosity 450 mPa.s
VZO 25 mounted on pressure side of pumps

- ① Viscosity curves DN 25
select closest curve
F = 500 mPa.s
- ② Assume max. permissible pressure drop = 1 bar
- ③ The intersection of curve F with the line corresponding to 1 bar gives a flow rate of 2000 l/h.

Part	Material	Meter Size DN						
		4	8	15	20	25	40	50
Housing / Measuring unit	Brass	●	●					
Housing with threaded ends	Cast brass			●	●	●		
	Spheroidal graphite iron GGG						●	
Housing with flanges	Spheroidal graphite iron GGG			●	●	●	●	●
Measuring chamber								
	- PN 16 / 25			●	●	●	●	
	- PN 40							●
Seals	NBR butadiene-acrylonitril	●						
	FPM fluorelastomer	S	●	●	●	●	●	●
Rotary piston	Anodized aluminium	●	●	●	●	●	●	●
Ancillaries	Plastic			●	●	●	●	●
Cover of meter	Plastic	●	●					

S = Special versions

Dimensions in mm

VZO/VZOA 4 and 8

DN 4

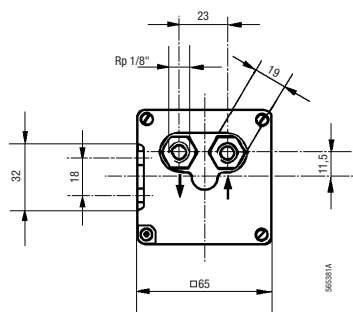

DN 8

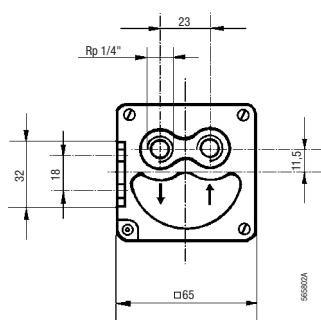

without pulser

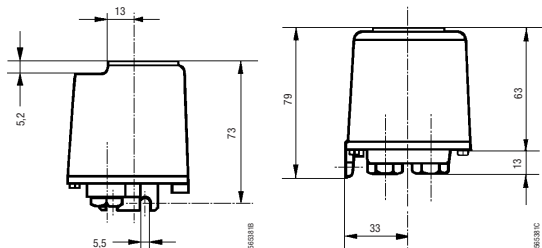

without pulser

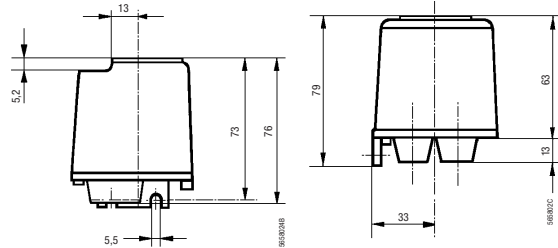

with pulser

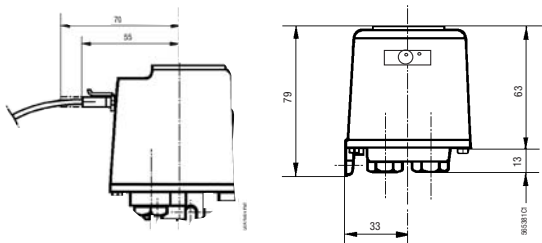

with pulser

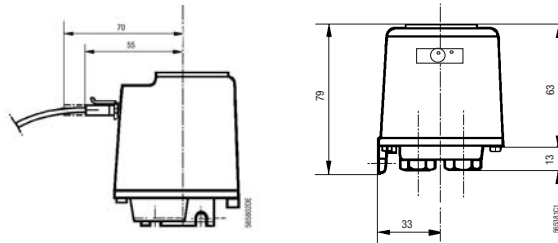

Dimensions in mm

Flow sensors (all types)

DN 15, 20, 25: with threaded ends

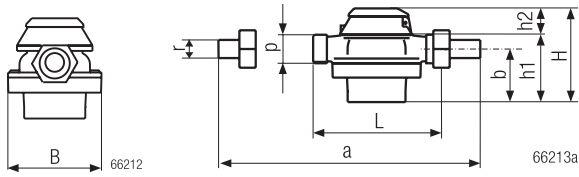

DN 40: with threaded ends

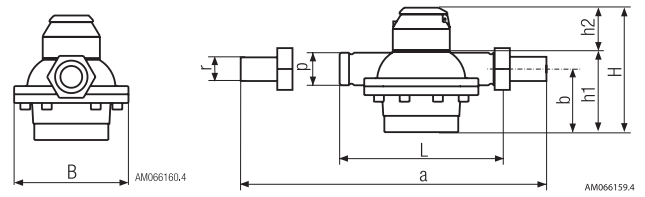

DN 15, 20, 25: with flanges (DIN 2501/SN 21843)

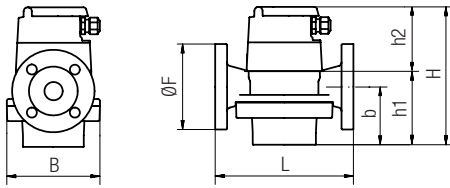

DN 40, 50: with flanges (DIN 2501/SN 21843)

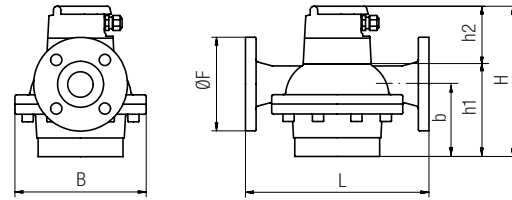

Nominal size	L	B	a	Ø F	b	h1	p	r
DN 15	165	105	260	95	45	65	G 3/4"	G 1/2"
DN 20	165	105	260	105	54	74	G 1"	G 3/4"
DN 25	190	130	305	115	77	101	G 1 1/4"	G 1"
DN 40	300	210	440	150	116	153	G 2"	G 1 1/2"
DN 50	350	280	—	165	166	209	—	—

Dimensions of transducer groups / measurement transducer

Oil flow meter	VZF / VZFA	VZO 15 - 25						VZO 40 - 50 / VZO A 15 - 50					
Max. temperature	130/180°C	130°C			180°C			130°C			180°C		
Pulsers	all	-	RV	IN	-	RV	IN	-	RV	IN	-	RV	IN
Dimensional drawing	1	2	3	4	5	4	7	5	4	6	5	4	7

VZF(A), VZO(A) Dimensional drawings 1 - 7 from table above

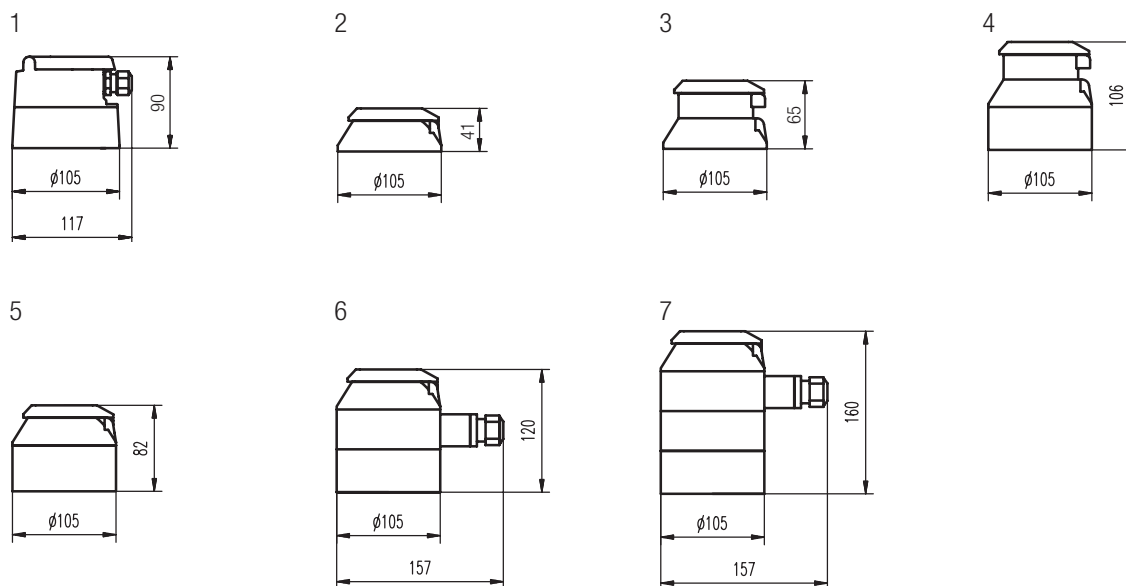

Display / Roller counter

VZF / VZFA



VZO / VZO A 15

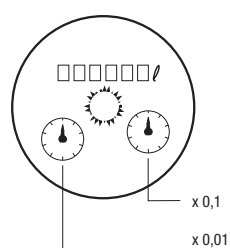

VZO / VZO A 20, 25, 40

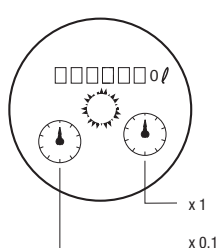

VZO / VZO A 50

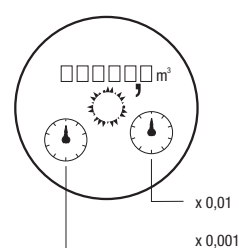

AM0660174

Selection of the optimal meter

Type	VZF	VZO	VZO	VZFA	VZOA	VZOA
	15-50	4-8	15-50	15-50	4-8	15-50
Application						
Direct consumption measurement	●	●	●	●	●	●
Differential measurement	–	–	–	●	–	●
Measuring points with metrolog. approval / calibration (optional)	–	–	–	–	●	●
Measuring points with marine type approval (optional)	○	–	●	○	–	●
Most frequent areas of use						
Domestic / industrial burner	light/medium oil	●	●	●	●	●
	heavy oil 1)	●	–	●	●	●
Diesel engines	diesel oil	●	●	●	●	●
Ship motors	heavy oil 1)	●	–	●	●	●
Petrol engines		2)			–	
Common applications						
Heating systems	●	●	●			
Ships	●		●	●		●
Diesel locomotives	●	●	●	●		●
Trucks/coaches/construction machinery		●	●			●
Fuel types						
Light heating fuel	●	●	●	●	●	●
Medium heating fuel	●	●	●	●		●
Heavy heating fuel	●	–	●	●	–	●
Diesel	●	●	●	●	●	●
Petrol 2)		2)				
Display of flow data						
Total volume	●	●	●	●	●	●
Resettable volume	●	–	–	●	–	–
Instantaneous flow rate	●	–	–	●	–	–
Method of display						
LCD Electronic display	●	–	–	●	–	–
Total volume display on roller counter	–	●	●	–	●	●
Measuring error limits						
± 1% if actual value	●	●	●	–	DN 4	–
± 0,5% of actual value or smaller	–	–	–	●	DN 8	●
PTB approval	–	–	–	○	●	●
EC approval/verification	–	–	–	–	DN 4	–
	–	–	–	–	DN 8	●
Outputs 4)						
Current output	●	–	–	●	–	–
Digital outputs	4..20mA	–	–	●	–	–
	volume pulses	●	–	–	●	–
	frequency signal	●	–	–	●	–
	min/max limiting values	●	–	–	●	–
Pulsar (Option)						
Inductive, with decadic pulse value	–	–	●	–	–	●
Reed pulser for remote totalisation	–	●	●	–	●	●

● applicable ○ on request
 – not applicable

Fuels and suitable Meter sizes	DN 4	DN 8	DN 15	DN 20	DN 25	DN 40	DN 50
Light heating fuel	●	●	●	●	●	●	●
Medium heating fuel	●	●	●	●	●	●	●
Heavy heating fuel	–	–	3)	●	●	●	●
Diesel	●	●	●	●	●	●	●
Petrol	2)	2)					

1) Only in accordance with the maximum mesh size of the dirt filter as per technical data.

2) Determine conditions of use with supplier (other measured values!).

3) DN 15 only when the plant has a dirt filter with a max. 0.1 mm mesh size.

4) Two freely selectable independent outputs are always available.

Application note

For viscosities higher than 5mPa.s or for installations on the suction side of a pump, pressure drop and possible limitation of flow range must be taken into consideration.

Fuel oils

Characteristics of different fuels

Fuel			extra light	light	medium	heavy	Bunker C
Density at 15° C	min.	kg/dm ³	0.82	0.82	0.82	0.82	0.90
	max.	kg/dm ³	0.86	0.95	0.96	0.99	1.01
Specific volume at average density		l/kg	1.19	1.12	1.12	1.11	1.08
Viscosity at	20° C	mPa.s	8	14	50	420	4200
	40° C	mPa.s	3	5	16	60	380
	100° C	mPa.s	–	–	3	10	35
Energy value		kWh/kg	11.8	10.6	11.4	11.2	11.0

Indicative values on power for burners and engines

Burners

Burner	Fuel oil meter				Size DN
	Power up to kW	Flow rate heating fuel EL		Flow rate Q _{min} ...Q _n l/h	
		kg/h	l/h		
500	42	50		1 ... 50	4
1 300	113	135		4 ... 135	8
4 000	336	400		10 ... 400	15
10 000	840	1 000		30 ... 1 000	20
20 000	1 680	2 000		75 ... 2 000	25
60 000	5 040	6 000		225 ... 6 000	40
200 000	16 800	20 000		750 ... 20 000	50

Formula for consumption in litres/hour:

Example:

$$\frac{\text{Burner power in kW}}{\text{Energy value of fuel in kWh/kg} \times \text{density in kg/dm}^3} = \frac{600 \text{ kW}}{11.8 \text{ kWh/kg} \times 0.82 \text{ kg/dm}^3} = 62 \text{ l/h}$$

Engines

Engine	Fuel oil meter ¹⁾				Size DN
	Power up to approx. PS	Diesel fuel consumption		Flow rate Q _{min} ...Q _n l/h	
	ca. kW	l/h			
250	184	50		1 ... 50	4
680	500	135		4 ... 135	8
2 000	1 470	400		10 ... 400	15
5 000	3 680	1 000		30 ... 1 000	20
10 000	7 360	2 000		75 ... 2 000	25
30 000	22 000	6 000		225 ... 6 000	40
100 000	73 600	20 000		750 ... 20 000	50

1) For differential measurement the flow meter has to be selected according to the pump flow rate and the flow in the return pipe.

Formula:

$$1 \text{ HP} = 0.736 \text{ kW} \quad 1 \text{ kg Diesel at } 0.84 \text{ kg/dm}^3 = 1.19 \text{ l}$$

$$1 \text{ kW} = 1.36 \text{ HP}$$

Rule of thumb:

approx. 190 g/kWh correspond to 0.226 l/kWh
 approx. 140 g/HP correspond to 0.167 l/HP/h

How to obtain an optimal measurement

Planning

Flow meters are precision measuring instruments. They achieve optimal results if

- a few important rules are observed during plant design,
- mounting and commissioning are carried out with care,
- the meters are used for their defined purpose only.

Layout of Pipework

- The quantities consumed by all consumers must be registered by the meter.
- Rotary piston meters do not require flow conditioners or inlet runs (after bends, T-pieces or fittings). They may be mounted in horizontal, vertical or inclined position, except with the head pointing downwards.
- The layout of piping must ensure that the meter is at all times filled with liquid and that no inclusions of air or gas may occur. Do not install the instrument at the highest point of the installation.
- Meter and accessory equipment must be easily accessible.

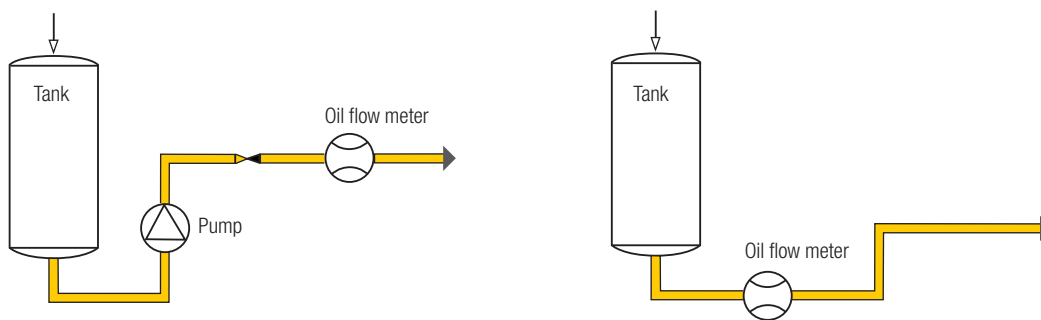

Selection of the Meter and Ancillaries

To be considered when selecting the meter:

- Operating temperature
- Viscosity of the medium
- Operating pressure
- Flow rate
- Resistance of the material against fuel to be metered and working conditions

The technical data are valid for the following reference conditions: EL heating fuel / diesel at 20° C. For higher viscosities or if the meter is mounted on the suction side of a pump, it is necessary to determine the pressure drop and the flow rate that can still be attained by using the pressure loss curves (page 25ff). If the pressure drop is more than 1 bar, it is advised to use the next larger meter size. Maximum permissible pressure drop = 3 bar.

Mounting on pressure side of pump (burners)

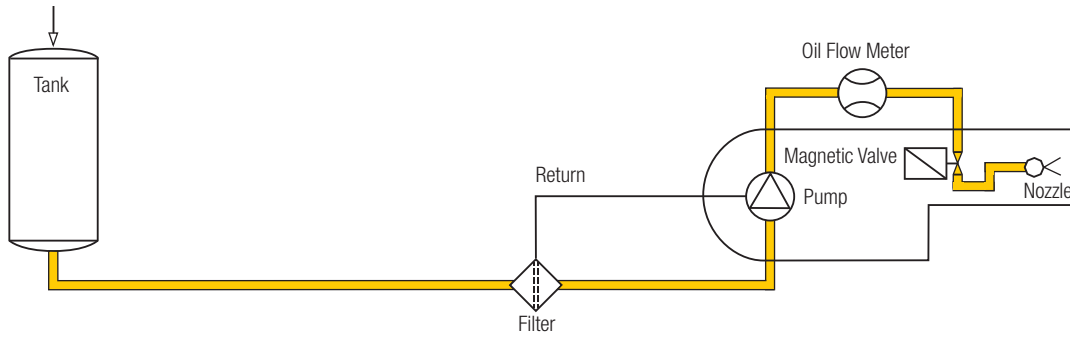

Mounting on suction side of pump (burners)

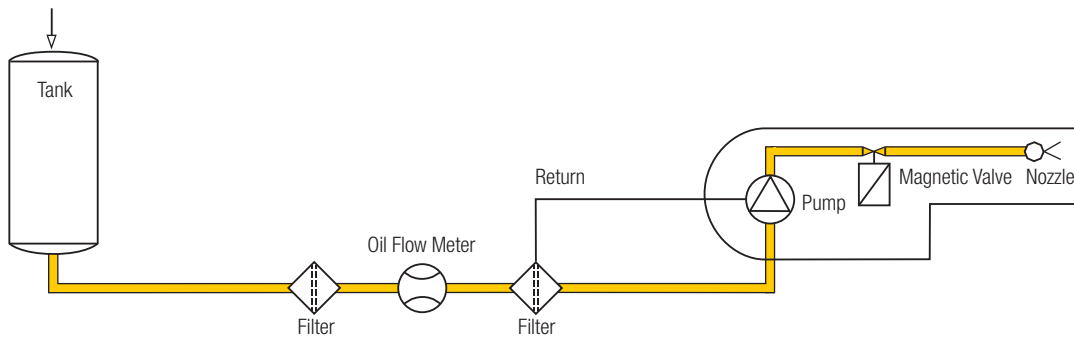

Impurities in plant or fuel

Should impurities occur in the plant or in the fuel, a dirt filter has to be installed before the meter. The filter mounted in the meter inlet is only a safety filter and is too small to act as a dirt filter.

Maximum mesh size of dirt filter	Meter	VZF	VZO	VZFA/VZOA
	DN 4	–	0,080 mm	0.080 mm
	DN 8	–	0.100 mm	0.100 mm
	DN 15	0.250 mm	0.250 mm	0.100 mm
	DN 20	0.400 mm	0.400 mm	0.100 mm
	DN 25	0.400 mm	0.400 mm	0.250 mm
	DN 40	0.600 mm	0.600 mm	0.250 mm
	DN 50	0.600 mm	0.600 mm	0.250 mm

Stop valves or cocks

In order to avoid backflow and draining, stop valves have to be mounted after the meter. Backflow and draining cause measuring errors and can damage the meter.

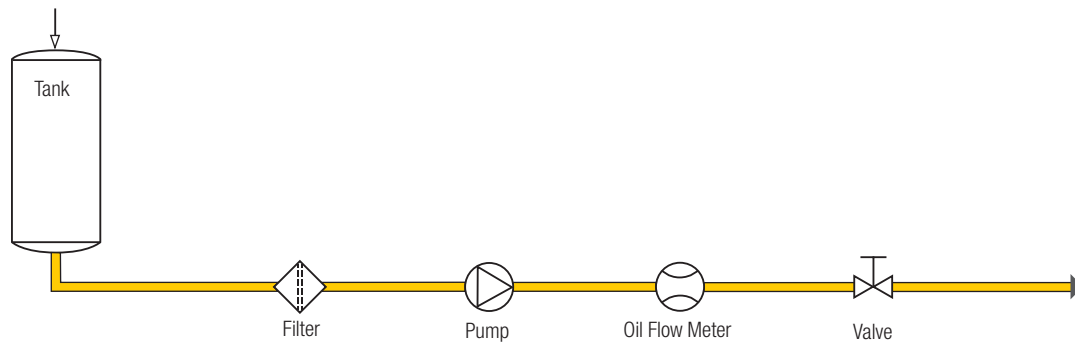

Filling/Dosing

For filling and dosing the valve has to be mounted between meter and outlet. The shorter the pipe section between meter and outlet, the higher the accuracy. Fast opening and shutting of the valve should be avoided (pressure hammer!).

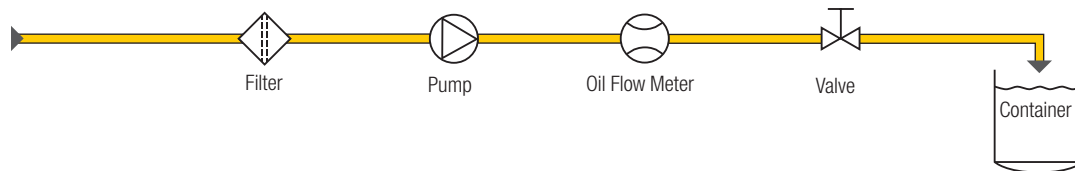

Remote Processing/Ancillaries

Any backflow must be avoided on meters equipped with pulsers for remote processing. If this cannot be achieved by appropriate plant design, a non-return valve should be fitted.

Electrical wiring and installations

Electrical wiring and installations are subject to statutory regulations which must be taken into account when planning the system. For installations in zones subject to explosion hazards, consult an appropriate expert.

The following factors should be taken into account during plant design:

- ancillaries connected to the meter
- environmental interference
- maximum permissible cable lengths (with or without amplifier)
- junction boxes, cable guides

Pulsers IN and RV

Power supply

Our range of products includes passive pulsers for the remote processing of flow data. The pulser generates one pulse per unit of volume and is to be supplied with power from the pulse processing device.

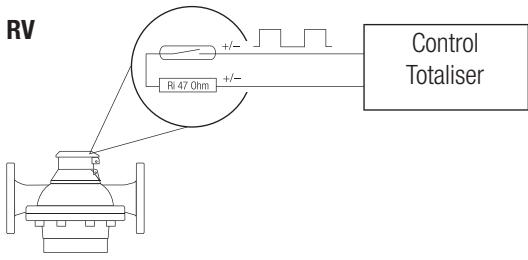

Power supply 5 ... 48 V AC/DC

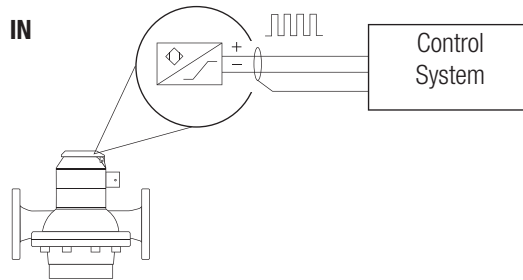

Power supply 5 ... 15 V DC

Selection of the appropriate pulser

The selection of the most appropriate pulser and pulse value depends on the application. As a rule, remote totalisation demands rather large pulse values, whereas analogue signals, dosing control or indication of actual flow rate tend to need small values. Battery supplied devices can only be used together with Reed pulsers.

Selection of the processing device

The pulse length depends on the flow rate. Continuous contact may occur at zero flow. The device connected must therefore be able to accept continuous load; otherwise, protective measures have to be taken. For remote totalisation, it is recommended to use an electronic pulse counter with a low power consumption and bounce filter.

Correct pulse processing

Interrupted flow may cause hydraulic oscillation of the liquid in certain plants (hydraulic vibration with minimal backward/forward flow). The pulses which can occur in such cases may be interpreted as forward flow by the connected device. Such faulty pulses do not affect the indication of the actual value since they can only occur at almost zero flow. However, if the pulser controls a counting device, hydraulic vibration must be avoided by an appropriate modification or layout of the plant.

Pulse values

Pulse values depend on type and nominal size of the meter. They are listed in the technical information of the meter concerned.

Pulse period

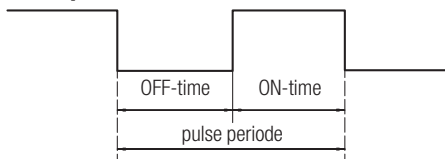

Pulse period as well as on- and off-times can be calculated with the following formula:

$$\text{Pulse period in s} = \frac{\text{pulse value in litres} \times 3600}{\text{flow Q in l/h}}$$

$$\text{On-time} = \frac{\text{pulse period in s} \times \text{on-time in \% of pulse period}}{100}$$

$$\text{Off-time} = \text{pulse period in s} \text{ minus on-time}$$

We recommend that this calculation be carried out for the highest and lowest expected flow rates.

Application examples

Diesel engine

Direct consumption measurement

Instead of returning the fuel back into the main tank, an intermediate tank equipped with a heat exchanger should be installed on the supply side of the system. The flow measurement is taken in the supply pipe to the intermediate tank. The load on the meter and the measuring result correspond precisely to the consumption.

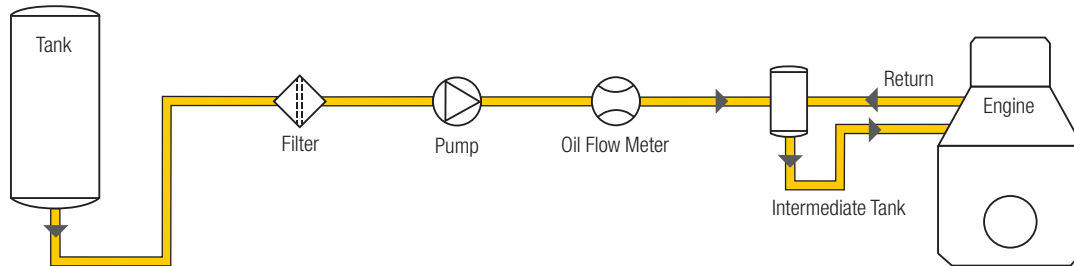

Differential measurements

For differential measurements, the piping remains unchanged, with circulation back into the tank. A flowmeter is installed in both supply and return pipes. The consumption is determined as the difference between the amount in the supply section and the amount in the return section. The meter loads therefore correspond to the supply and return flow rates.

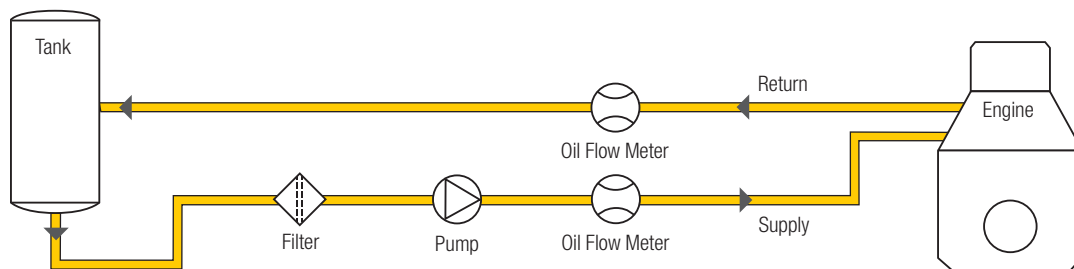

Reasons for using special meters for differential measurements

Standard meters feature a large measuring range and a max. permissible error of $\pm 1\%$. This makes them unsuitable for differential measurements, as the following example shows:

Full load	Supply	400 l/h	Error $\pm 1\%$	= nominal ± 4.0 l
	Return	150 l/h	Error $\pm 1\%$	= nominal ± 1.5 l
	Consumed	250 l/h	Divergence	nominal ± 5.5 l
	Maximum divergence	Consumed = $5.5 \times 100 : 250 = \pm 2.2\%$		
Min. load	Supply	400 l/h	Error $\pm 1\%$	= nominal ± 4.0 l
	Return	360 l/h	Error $\pm 1\%$	= nominal ± 3.6 l
	Consumed	40 l/h	Divergence	nominal ± 7.6 l
	Maximum divergence	Consumed = $7.6 \times 100 : 40 = \pm 19\%$		

For an optimal result, special meters are therefore used for differential measurements. These are precisely matched to the operating conditions and are calibrated in pairs. This means that the measurement error can be significantly reduced (for example: $\pm 0.1\%$ at constant flow rates on the supply side and $\pm 0.3\%$ with slightly variable flow rates on the return side).

Loads on meters

Example: Engine power 500 hp, vehicle with electric pump

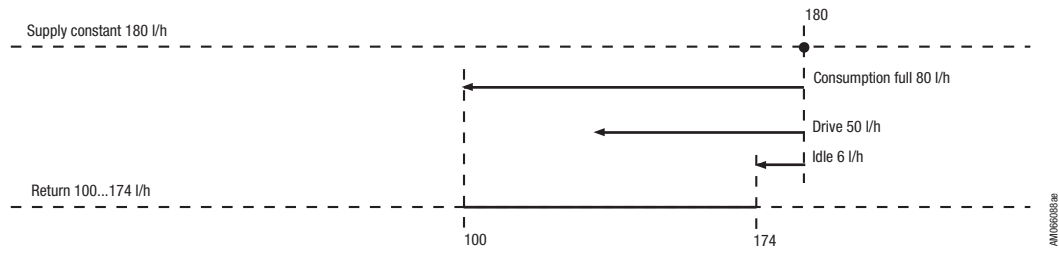

Effective loads on meters

Supply	constant 180 l/h
Return	100 ... 174 l/h

Example: Engine power 500 hp, vehicle with revolution speed dependent pump 1:4

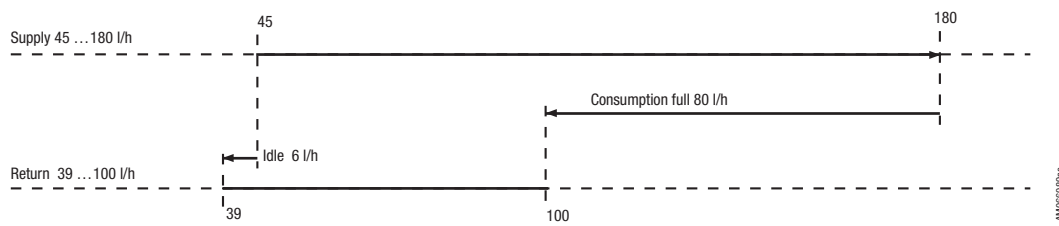

Effective loads on meters

Supply	45 ... 180 l/h
Return	39 ... 100 l/h

Consumption measurement on ships

On ships, care is usually taken to ensure that the engine can still be operated at full power even if the filter is heavily contaminated or if the meter is damaged. When switching over to the bypass, attention may be drawn to the necessary maintenance via an alarm output, and the engine can be temporarily operated without measuring the consumption.

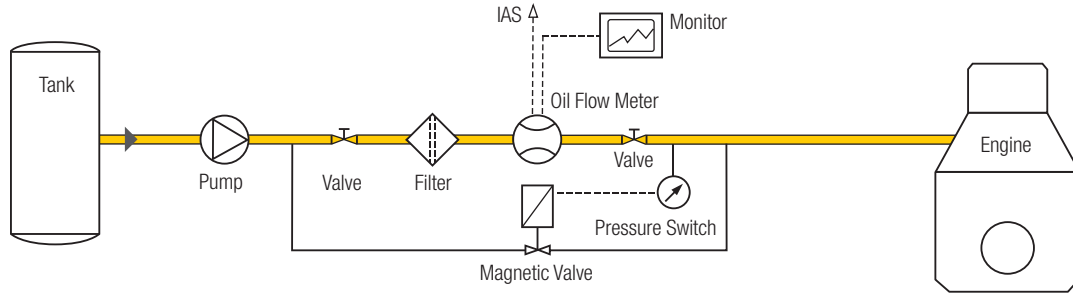

The magnetic valve opens as soon as the pressure drops below a defined level.

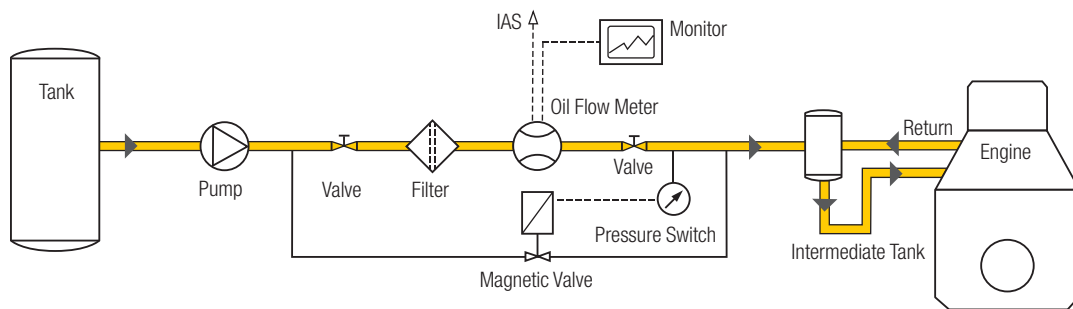

Float or valve control in the intermediate tank is required. Formation of gas is to be avoided. The magnetic valve opens as soon as the pressure drops below a defined level. For measuring the consumption of more than one engine, each will require a separate installation similar to the one above.

Installation of meter on suction side of pump

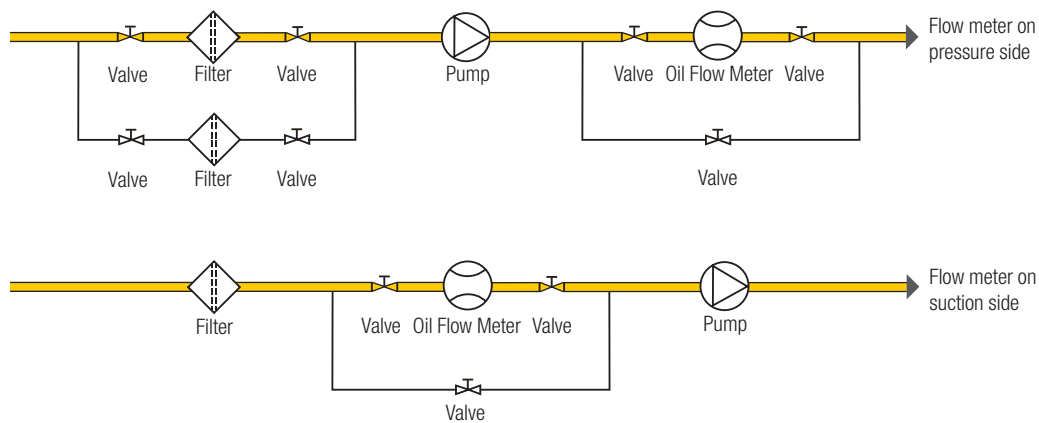

If the flow meter is installed on the suction side of the pump, the pressure drop at the max. allowed flow rate and highest possible viscosity must be taken into account. Also to be considered are installed filters.