

STAUFF
ANGLIA



**MULTI SPIRAL HOSE
NON SKIVE MULTI SPIRAL HOSE INSERTS**



*HIGH SPEED ASSEMBLY
HIGH PRESSURE PERFORMANCE*

Stauff Anglia Limited

405 Coppersmith Way | Wymondham | Norfolk NR18 0WY

T: 01953 857158 F: 01953 857159 E: Sales@stauffanglia.co.uk

www.stauffanglia.co.uk

CONTENTS

Multi Spiral Hose	DIN EN 856 4SP DIN EN 856 4SH	P1
Multi Spiral Hose	DIN EN 856 SAE 100R12 DIN EN 856 SAE 100R13	P2
Multi Spiral Hose	SAE 100R15 Flexline 4000	P3
Multi Spiral Hose	STAUFF <i>Shield</i> SSP STAUFF <i>Shield</i> SSH	P4
Ferrules	BSN BSS	P5
BSP males		P6
BSP Females	45 90	P7
NPT Males	JIC Males JIC Females	P8
JIC 45	90 90 Long Drop	P9
ORFS Males	Females	P10
ORFS 45	90 90 Long Drop	P11
Metric (Heavy Duty) Males	Females 45 90	P12
Flanges	Straight Elbow 45 - ISO L SAE Code 61	P13
Flanges Elbow 90	- ISO L SAE Code 61	P14
Flanges Elbow 22.5	30 60 - ISO L SAE Code 61	P15
Flanges Elbow 67.5	100 110 135 - ISO L SAE Code 61	P16
Flanges Elbow 90 Long Drop	- ISO L SAE Code 61 'O' seals	P17
Flanges Straight	Elbow 45 90 - ISO S SAE Code 62	P18
Flanges Elbow 22.5	30 60 - ISO S SAE Code 62	P19
Flanges Elbow 67.5	90 Long Drop - ISO S SAE Code 62 'O' seals	P20
Supercat Flanges Straight	Elbow 45 90	P21
Supercat Flanges Elbow 22.5	30 60	P22
Supercat Flanges Elbow 67.5	90 Long Drop D Ring Seals	P23
Female Swivel Ends	Torque values	P24
Hose Assembly Procedures		P25 - 28

STAUFF Multispiral Hoses

plus 4SH PREMIUM

**All STAUFF Flex
Spiral hoses are fully branded :
Flame Resistant
US MSHA APPROVAL
NO. IC-188**



DIN EN 856 4SP

General : Tube - oil resistant synthetic rubber | Cover - abrasion, ozone and weather resistant synthetic rubber

Temperature Range : -40° C + 100° C (120° C Max)

Reinforcement : four high tensile steel wire spiral layers

Nominal	MM	Wire	Cover	Working	WP Pressure	Burst	Bend	Weight	Part Number
Bore		OD mm	OD	Pressure	PSI	Pressure Bar	Radius mm	Kg/M	
3/8	9,5	17,5	21,4	445	6450	1780	180	0,78	
1/2	12,7	20,2	24,6	415	6000	1660	230	0,93	
5/8	15,9	23,8	28,2	350	5000	1400	250	1,17	
3/4	19,0	28,2	32,2	350	5000	1400	300	1,48	
1	25,4	35,3	39,7	280	4000	670	340	2,02	
1-1/4	31,8	46,0	50,8	210	3000	500	460	3,05	
1-1/2	38,1	52,4	57,2	185	2650	740	560	3,52	
2	50,8	65,3	69,8	165	2360	660	660	5,20	

DIN EN856 4SH

General : Tube - oil resistant synthetic rubber | Cover - abrasion, ozone and weather resistant synthetic rubber

Temperature Range : -40° C + 100° C (120° C Max)

Reinforcement : four high tensile steel wire spiral layers

Nominal	MM	Wire	Cover	Working	WP Pressure	Burst	Bend	Weight	Part Number
Bore		OD mm	OD	Pressure	PSI	Pressure Bar	Radius mm	Kg/M	
3/4	19,0	28,4	32,2	420	6095	1680	280	1,53	
1	25,4	35,2	38,7	380	5515	1520	340	2,06	
1-1/4	31,8	41,9	45,5	345	5000	1380	460	2,46	
1-1/2	38,1	48,8	53,5	290	4200	1160	560	3,35	
2	50,8	63,2	68,1	250	3625	1000	700	4,55	

4SH PREMIUM exceeds DIN EN 856 4SH MILLION Cycle Tested									
3/4"	19	28.4	32.2	430	6235	1720	210	1.53	
1	25,4	35,2	38,7	400	5800	1600	220	2,06	
1-1/4	31,8	41,9	45,5	360	5220	1440	240	2,46	

STAUFF Multispiral Hoses

DIN EN 856 SAE 100R12

DIN EN 856 SAE 100R13

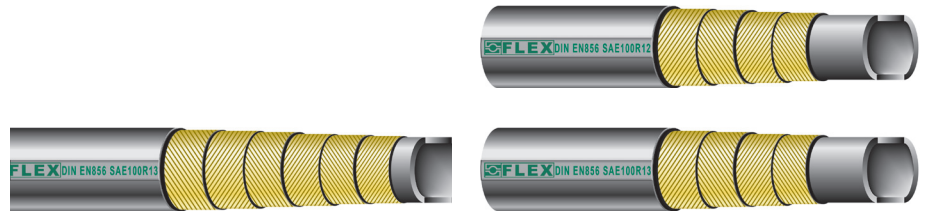

DIN EN 856 SAE 100R12

General : Tube - oil resistant synthetic rubber | Cover - abrasion, ozone and weather resistant synthetic rubber

Temperature Range : -40° C + 100° C (120° C Max)

Reinforcement : four high tensile steel wire spiral layers

Nominal	MM	Wire	Cover	Working	WP Pressure	Burst	Bend	Weight	Part Number
Bore		OD mm	OD	Pressure	PSI	Pressure Bar	Radius mm	Kg/M	
3/8	9,5	17,2	20,3	280	4060	1120	130	0,70	
1/2	12,7	20,7	23,8	280	4060	1120	180	0,84	
5/8	15,9	24,6	27,4	280	4060	1120	200	1,10	
3/4	19,0	27,7	30,7	280	4060	1120	240	1,33	
1	25,4	34,9	38,0	280	4060	1120	300	1,85	
1-1/4	31,8	43,9	47,0	210	3045	840	420	2,65	
1-1/2	38,1	50,4	53,5	210	2540	700	500	3,20	
2	50,8	63,7	66,7	175	2540	700	630	4,50	

DIN EN856 SAE 100R13

General : Tube - oil resistant synthetic rubber | Cover - abrasion, ozone and weather resistant synthetic rubber

Temperature Range : -40° C + 100° C (120° C Max)

Reinforcement : four / six high tensile steel wire spiral layers

Nominal	MM	Wire	Cover	Working	WP Pressure	Burst	Bend	Weight	Part Number
Bore		OD mm	OD	Pressure	PSI	Pressure Bar	Radius mm	Kg/M	
3/4	19,0	29,2	32,0	350	5075	1400	240	1,65	
1	25,4	35,9	39,2	350	5075	1400	300	2,25	
1-1/4	31,8	46,8	49,8	350	5000	1400	420	3,60	
1-1/2	38,1	54,0	57,3	350	5075	1400	500	4,75	
2	50,8	68,4	71,9	350	5075	1400	630	6,90	

STAUFF Multispiral Hoses

SAE 100R15

Flexline 4000

plus R15 PREMIUM

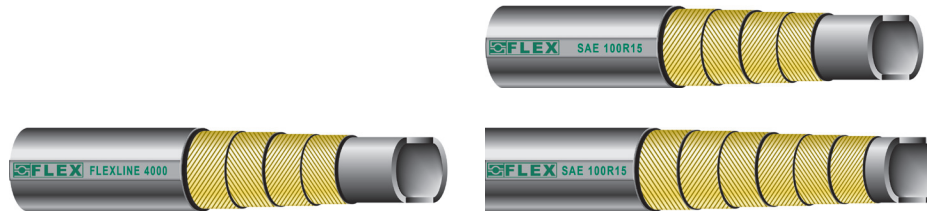

SAE 100R15

General : Tube - oil resistant synthetic rubber | Cover - abrasion, ozone and weather resistant synthetic rubber

Temperature Range : -40° C + 100° C (120° C Max)

Reinforcement : four / six high tensile steel wire spiral layers

Nominal	MM	Wire	Cover	Working	WP Pressure	Burst	Bend	Weight	Part Number
Bore		OD mm	OD	Pressure	PSI	Pressure Bar	Radius mm	Kg/M	
3/4	19,0	32,9	36,1	420	6090	1680	267	1,50	
1	25,4	38,9	42,9	420	6090	1680	330	2,10	
1-1/4	31,8	48,4	51,5	420	6090	1680	445	3,60	
1-1/2	38,1	56,3*	59,6*	420	6090	1680	533	5,10	

|| || R15 PREMIUM Exceeds SAE100 R15 MILLION cycle tested || ||

3/4"	19	28.4	32.2	425	6160	1700	210	1.53	
1"	25	35.2	38.7	425	6160	1700	220	2.06	

FLEXLINE 4000

General : Tube - oil resistant synthetic rubber | Cover - abrasion, ozone and weather resistant synthetic rubber

Temperature Range : -40° C + 100° C (120° C Max)

Reinforcement : four high tensile steel wire spiral layers

Nominal	MM	Wire	Cover	Working	WP Pressure	Burst	Bend	Weight	Part Number
Bore		OD mm	OD	Pressure	PSI	Pressure Bar	Radius mm	Kg/M	
3/8	9,5	17,2	20,3	280	4060	1120	65	0,70	
1/2	12,7	20,7	23,8	280	4060	1120	90	0,84	
5/8	15,9	24,6	27,4	280	4060	1120	100	1,10	
3/4	19,0	27,7	30,7	280	4060	1120	120	1,33	
1	25,4	34,9	38,0	280	4060	1120	155	1,85	

STAUFF High Abrasion resistant
Hydraulic Hoses

STAUFFShield SSP

STAUFFShield SSH

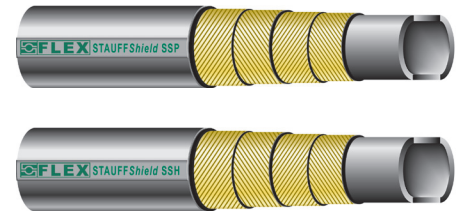

STAUFFShield SSP

General : Tube - oil resistant synthetic rubber | Cover: double layer construction – rubber cover with UHMW foil, MSHA approved

Temperature Range : -40°C to +100°C, peak temp. 120°C

Reinforcement : 4 High tensile steel spiral braids

Nominal Bore	MM	Wire OD mm	Cover OD	Working Pressure	WP Pressure PSI	Burst Pressure Bar	Bend Radius mm	Weight Kg/M	Part Number
3/8	9,5	17,5	21,4	445	6455	1780	180	0,78	
1/2	12,7	20,2	24,6	425	6165	1700	230	0,93	
5/8	15,9	23,8	28,2	350	5075	1400	250	1,17	
3/4	19,0	28,2	32,2	350	5075	1400	300	1,48	
1	25,4	35,3	39,7	280	4060	1120	340	2,02	

STAUFFShield SSH

General : Tube - oil resistant synthetic rubber | Cover: double layer construction – rubber cover with UHMW foil, MSHA approved

Temperature Range : -40°C to +100°C, peak temp. 120°C

Reinforcement : 4 High tensile steel spiral braids

Nominal Bore	MM	Wire OD mm	Cover OD	Working Pressure	WP Pressure PSI	Burst Pressure Bar	Bend Radius mm	Weight Kg/M	Part Number
3/4	19,0	28,4	32,2	420	6090	1680	280	1,53	
1	25,4	35,2	38,7	380	5510	1520	340	2,06	
1-1/4	31,8	41,9	45,5	345	5000	1380	460	2,46	
1-1/2	38,1	48,8	53,5	290	4205	1160	560	3,35	
2	50,8	63,2	68,1	250	3625	1000	700	4,55	

NON SKIVE SWAGED FERRULE

Part. N°	Hose I.D.			Dimensions (mm)		Applications					
	DN	SIZE	Inch	D	L						
BSN412	19	12	3/4"	43	50	4SP	4SH	R9R	R12	R13	R15
BSN416	25	16	1"	51	56	4SP	4SH	R9R	R12	R13	R15
BSN420	31	20	1 1/4"	61	68		4SH	R9R	R12		
BSN424	38	24	1 1/2"	70	86		4SH	R9R	R12		
BSN432	51	32	2"	85	100		4SH	R9R	R12		

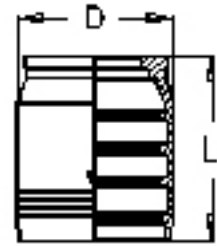

OUTSIDE SKIVE SWAGED FERRULE

Part. N°	Hose I.D.			Dimensions (mm)		Applications					
	DN	SIZE	Inch	D	L						
BSS412	19	12	3/4"	38	54	4SP	4SH	R9R	R12	R13	R15
BSS416	25	16	1"	46	60	4SP	4SH	R9R	R12	R13	R15
BSS420	31	20	1 1/4"	54	72		4SH	R9R	R12		
BSS424	38	24	1 1/2"	62	90		4SH	R9R	R12		
BSS432	51	32	2"	76	102		4SH	R9R	R12		

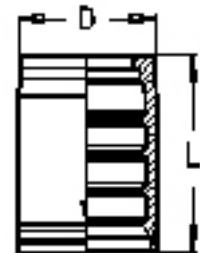

OUTSIDE SKIVE SWAGED FERRULE

Part. N°	Hose I.D.			Dimensions (mm)		Applications					
	DN	SIZE	Inch	D	L						
BSS620	31	20	1 1/4"	58	72	4SP				R13	R15
BSS624	38	24	1 1/2"	68	90	4SP				R13	R15
BSS632	51	32	2"	84	102	4SP				R13	

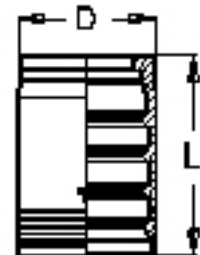

BSP PARALLEL MALE - 60° CONE SEAT

Part.N.	Hose I.D.			Thread	Dimensions (mm)		
	DN	Size	Inch	F	H	L	S
CS1212MG	20	12	3/4"	3/4"-14	38	89	32
CS1216MG	20	12	3/4"	1"-11	43	94	41
CS1616MG	25	16	1"	1"-11	45	101	41
CS1620MG	25	16	1"	1 1/4"-11	48	104	50
CS2020MG	32	20	1 1/4"	1 1/4"-11	50	117	50
CS2024MG	32	20	1 1/4"	1 1/2"-11	53	120	55
CS2424MG	40	24	1 1/2"	1 1/2"-11	55	138	55
CS3232MG	50	32	2"	2"-11	63	159	70

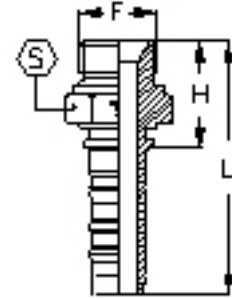

BSP TAPER MALE - 60° CONE SEAT

Part.N.	Hose I.D.			Thread	Dimensions (mm)		
	DN	Size	Inch	F	H	L	S
CS1212MGC	20	12	3/4"	3/4"-14	37	88	27
CS1616MGC	25	16	1"	1"-11	44	101	36
CS2020MGC	32	20	1 1/4"	1 1/4"-11	51	118	46
CS2424MGC	40	24	1 1/2"	1 1/2"-11	54	137	50
CS3232MGC	50	32	2"	2"-11	64	160	65

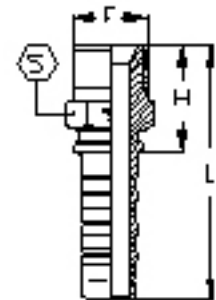

BSP STRAIGHT FEMALE - 60° O'RING CONE - TIEFFE NUT

Part.N.	Hose I.D.			Thread		Dimensions (mm)			
	DN	Size	Inch	F	H	L	S	O'Ring	
CS1212FGO	20	12	3/4"	3/4"-14	29	80	32	17x1,5	
CS1216FGO	20	12	3/4"	1"-11	32	83	41	22x1,5	
CS1616FGO	25	16	1"	1"-11	34	90	41	22x1,5	
CS1620FGO	25	16	1"	1 1/4"-11	37	93	50	28,3x1,78	
CS2020FGO	32	20	1 1/4"	1 1/4"-11	39	106	50	28,3x1,78	
CS2024FGO	32	20	1 1/4"	1 1/2"-11	41	107	60	33,05x1,78	
CS2424FGO	40	24	1 1/2"	1 1/2"-11	43	125	60	33,05x1,78	
CS3232FGO	50	32	2"	2"-11	47	143	75	44,17x1,78	

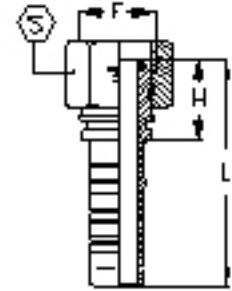

45° BSP SWEEP ELBOW - 60° O'RING CONE - TIEFFE NUT

Part.N.	Hose I.D.			Thread		Dimensions (mm)			
	DN	Size	Inch	F	H	L	K	S	O'Ring
CS1212FGO45	20	12	3/4"	3/4"-14	67	118	29	32	17x1,5
CS1216FGO45	20	12	3/4"	1"-11	67	118	29	41	22x1,5
CS1616FGO45	25	16	1"	1"-11	86	142	36	41	22x1,5
CS1620FGO45	25	16	1"	1 1/4"-11	86	142	36	50	28,3x1,78
CS2020FGO45	32	20	1 1/4"	1 1/4"-11	103	169	43	50	28,3x1,78
CS2024FGO45	32	20	1 1/4"	1 1/2"-11	103	169	43	60	33,05x1,78
CS2424FGO45	40	24	1 1/2"	1 1/2"-11	123	206	51	60	33,05x1,78
CS3232FGO45	50	32	2"	2"-11	160	257	65	75	44,17x1,78

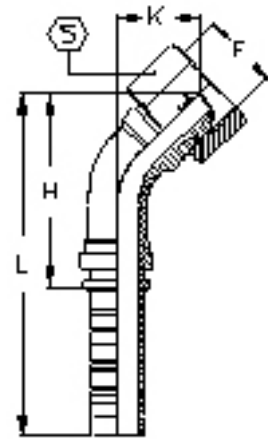

90° BSP SWEEP ELBOW - 60° O'RING CONE - TIEFFE NUT

Part.N.	Hose I.D.			Thread		Dimensions (mm)			
	DN	Size	Inch	F	H	L	K	S	O'Ring
CS1212FGO90	20	12	3/4"	3/4"-14	55	106	57	32	17x1,5
CS1216FGO90	20	12	3/4"	1"-11	55	106	57	41	22x1,5
CS1616FGO90	25	16	1"	1"-11	71	128	72	41	22x1,5
CS1620FGO90	25	16	1"	1 1/4"-11	71	128	72	50	28,3x1,78
CS2020FGO90	32	20	1 1/4"	1 1/4"-11	87	154	88	50	28,3x1,78
CS2024FGO90	32	20	1 1/4"	1 1/2"-11	87	154	88	60	33,05x1,78
CS2424FGO90	40	24	1 1/2"	1 1/2"-11	105	188	104	60	33,05x1,78
CS3232FGO90	50	32	2"	2"-11	140	237	137	75	44,17x1,78

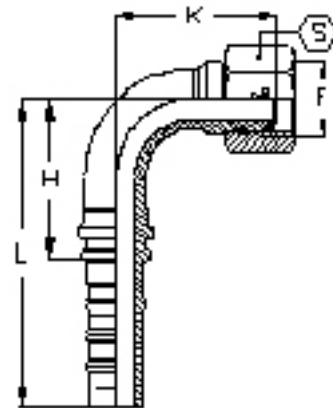

N.P.T.F. MALE - 60° CONE SEAT

Part.N.	Hose I.D.			Thread		Dimensions (mm)			
	DN	Size	Inch	F	H	L	S		
CS1212NPT	20	12	3/4"	3/4"-14	39	90	27		
CS1216NPT	20	12	3/4"	1"-11,5	47	98	36		
CS1612NPT	20	12	3/4"	3/4"-14	41.5	98	32		
CS1616NPT	20	12	3/4"	1"-11,5	48.5	105	36		
CS1620NPT	20	12	3/4"	1 1/4"-11,5	53	109.5	46		
CS2016NPT	32	20	1 1/4"	1"-11,5	52.5	119	41		
CS2020NPT	32	20	1 1/4"	1 1/4"-11,5	55	121.5	46		
CS2024NPT	32	20	1 1/4"	1 1/2"-11,5	59	125.5	50		
CS2424NPT	38	24	1 1/2"	1 1/2"-11,5	61	143.5	50		
CS2432NPT	38	24	1 1/2"	2"-11,5	67.5	150	65		
CS3232NPT	51	32	2"	2"-11,5	70.5	167	65		

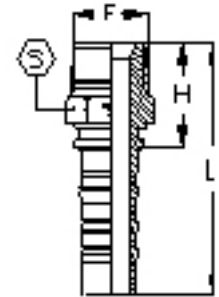

J.I.C. MALE - 74° CONE

Part.N.	Hose I.D.			Thread		Dimensions (mm)			
	DN	Size	Inch	F	H	L	S		
CS1210MI	20	12	3/4"	7/8"-14	37	88	27		
CS1212MI	20	12	3/4"	1 1/16"-12	40	91	27		
CS1214MI	20	12	3/4"	1 3/16"-12	41.5	92.5	32		
CS1216MI	20	12	3/4"	1 5/16"-12	43	94	36		
CS1612MI	25	16	1"	1 1/16"-12	43	99.5	32		
CS1616MI	25	16	1"	1 5/16"-12	45	101.5	36		
CS1620MI	25	16	1"	1 5/8"-12	48	104.5	46		
CS2016MI	32	20	1 1/4"	1 5/16"-12	48.5	115	41		
CS2020MI	32	20	1 1/4"	1 5/8"-12	50.5	117	46		
CS2024MI	32	20	1 1/4"	1 7/8"-12	55	121.5	50		
CS2424MI	38	24	1 1/2"	1 7/8"-12	57	139.5	50		
CS2432MI	38	24	1 1/2"	2 1/2"-12	65.5	148	65		
CS3232MI	51	32	2"	2 1/2"-12	68.5	165	65		

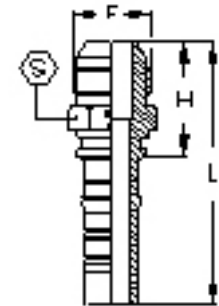

J.I.C. FEMALE - 74° CONE SEAT - DOUBLE HEXAGON -TIEFFE NUT

Part.N.	Hose I.D.			Thread		Dimensions (mm)			
	DN	Size	Inch	F	H	L	S	S1	
CS1210FIC	20	12	3/4"	7/8"-14	33	84	27	27	
CS1212FIC	20	12	3/4"	1 1/16"-12	34	85	32	27	
CS1214FIC	20	12	3/4"	1 3/16"-12	35.5	86.5	36	30	
CS1216FIC	20	12	3/4"	1 5/16"-12	38	89	41	32	
CS1612FIC	25	16	1"	1 1/16"-12	36.5	93	32	32	
CS1616FIC	25	16	1"	1 5/16"-12	39.5	96	41	32	
CS1620FIC	25	16	1"	1 5/8"-12	46	102.5	50	41	
CS2016FIC	32	20	1 1/4"	1 5/16"-12	45.5	112	41	41	
CS2020FIC	32	20	1 1/4"	1 5/8"-12	48	114.5	50	41	
CS2024FIC	32	20	1 1/4"	1 7/8"-12	51	117.5	60	46	
CS2424FIC	38	24	1 1/2"	1 7/8"-12	53	135.5	60	46	
CS2432FIC	38	24	1 1/2"	2 1/2"-12	66	148.5	75	60	
CS3232FIC	51	32	2"	2 1/2"-12	69	165.5	75	60	

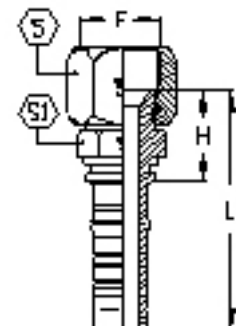

JIC 45° Elbow | 90° Elbow

90° Long Drop Elbow

JIC 45° SWEPT ELBOW - 74° CONE SEAT - TIEFFE NUT

Part.N.	Hose I.D.			Thread F	Dimensions (mm)				
	DN	Size	Inch		H	L	K	S	
CS1210FIS45	20	12	3/4"	7/8"-14	66	117	28	27	
CS1212FIS45	20	12	3/4"	1 1/16"-12	63	114	25	32	
CS1214FIS45	20	12	3/4"	1 3/16"-12	63	114	25	36	
CS1216FIS45	20	12	3/4"	1 5/16"-12	63	114	25	41	
CS1612FIS45	25	16	1"	1 1/16"-12	85	141	35	32	
CS1616FIS45	25	16	1"	1 5/16"-12	82	138	32	41	
CS1620FIS45	25	16	1"	1 5/8"-12	82	138	32	50	
CS2016FIS45	32	20	1 1/4"	1 5/16"-12	100	167	41	41	
CS2020FIS45	32	20	1 1/4"	1 5/8"-12	98	164	38	50	
CS2024FIS45	32	20	1 1/4"	1 7/8"-12	98	164	38	60	
CS2424FIS45	38	24	1 1/2"	1 7/8"-12	118	201	46	60	
CS2432FIS45	38	24	1 1/2"	2 1/2"-12	118	201	46	75	
CS3232FIS45	51	32	2"	2 1/2"-12	157	253	62	75	

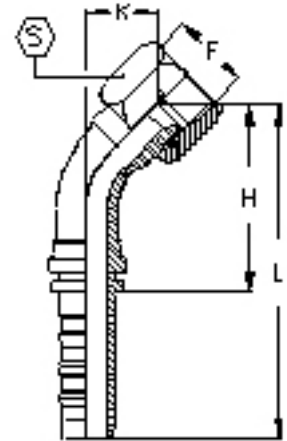

JIC 90° SWEPT ELBOW - 74° CONE SEAT - TIEFFE NUT

Part.N.	Hose I.D.			Thread F	Dimensions (mm)				
	DN	Size	Inch		H	L	K	S	
CS1210FIS90	20	12	3/4"	7/8"-14	55	106	55	27	
CS1212FIS90	20	12	3/4"	1 1/16"-12	55	106	52	32	
CS1214FIS90	20	12	3/4"	1 3/16"-12	55	106	52	36	
CS1216FIS90	20	12	3/4"	1 5/16"-12	55	106	52	41	
CS1612FIS90	25	16	1"	1 1/16"-12	71	128	71	32	
CS1616FIS90	25	16	1"	1 5/16"-12	71	128	67	41	
CS1620FIS90	25	16	1"	1 5/8"-12	71	128	67	50	
CS2016FIS90	32	20	1 1/4"	1 5/16"-12	87	154	84	41	
CS2020FIS90	32	20	1 1/4"	1 5/8"-12	87	154	81	50	
CS2024FIS90	32	20	1 1/4"	1 7/8"-12	87	154	81	60	
CS2424FIS90	38	24	1 1/2"	1 7/8"-12	105	188	97	60	
CS2432FIS90	38	24	1 1/2"	2 1/2"-12	105	188	97	75	
CS3232FIS90	51	32	2"	2 1/2"-12	140	237	132	75	

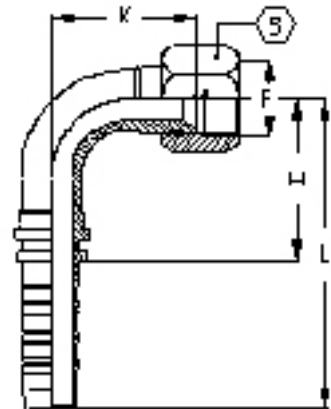

JIC 90° LONG DROP SWEPT ELBOW - 74° CONE SEAT - TIEFFE NUT

Part.N.	Hose I.D.			Thread F	Dimensions (mm)				
	DN	Size	Inch		H	L	K	S	
CS1212FIS90-K96	20	12	3/4"	1 1/16"-12	55	106	96	32	
CS1616FIS90-K116	25	16	1"	1 5/16"-12	71	128	116	41	
CS1620FIS90-K116	25	16	1"	1 5/8"-12	71	128	116	50	
CS2020FIS90-K136	32	20	1 1/4"	1 5/8"-12	87	154	136	50	
CS2424FIS90-K162	38	24	1 1/2"	1 7/8"-12	105	188	162	60	
CS3232FIS90-K220	51	32	2"	2 1/2"-12	140	137	220	75	

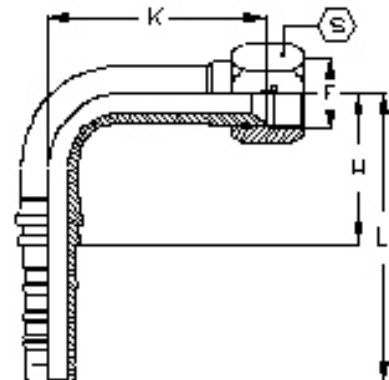

ORFS MALE

Part No	Hose I.D.			Thread		Dimensions (mm)			
	DN	Size	Inch	F	H	L	S		
	CS1212MRS	20	12	3/4"	1 3/16"-12	36	87	32	
CS1616MRS	25	16	1"	1 7/16"-12	41	97	41		
CS2020MRS	32	20	1 1/4"	1 11/16"-12	44	111	46		
CS2424MRS	40	24	1 1/2"	2"-12	48	131	55		

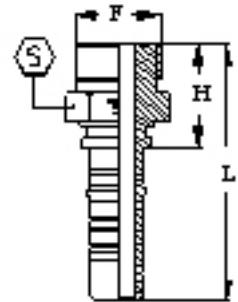

DOUBLE HEXAGON ORFS STRAIGHT FEMALE - PRESSED NUT

Part.N.	Hose I.D.			Thread		Dimensions (mm)			
	DN	Size	Inch	F	H	L	S	S1	
	CS1210FRC	20	12	3/4"	1"-14	43	94	30	27
CS1212FRC	20	12	3/4"	1 3/16"-12	46	97	36	30	
CS1216FRC	20	12	3/4"	1 7/16"-12	49	100	41	36	
CS1616FRC	25	16	1"	1 7/16"-12	51	107	41	36	
CS1620FRC	25	16	1"	1 11/16"-12	52	109	50	41	
CS2020FRC	32	20	1 1/4"	1 11/16"-12	55	121	50	41	
CS2424FRC	40	24	1 1/2"	2"-12	60	142	60	50	

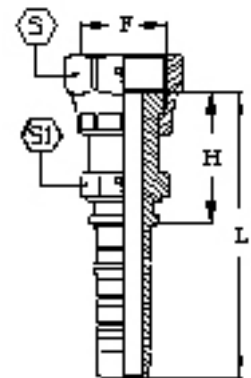

45° ORFS SWEPT ELBOW - SLIP ON NUT

Part.N.	Hose I.D.			Thread	Dimensions (mm)				
	DN	Size	Inch		F	H	L	K	S
CS1212FRS45	20	12	3/4"	1 3/16"-12	60	111	22	36	
CS1216FRS45	20	12	3/4"	1 7/16"-12	61	112	23	41	
CS1616FRS45	25	16	1"	1 7/16"-12	78	134	29	41	
CS1620FRS45	25	16	1"	1 11/16"-12	78	134	29	50	
CS2020FRS45	32	20	1 1/4"	1 11/16"-12	93	159	34	50	
CS2424FRS45	40	24	1 1/2"	2"-12	113	195	41	60	

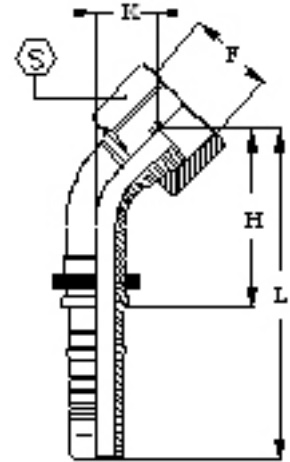

90° ORFS SWEPT ELBOW - SLIP ON NUT

Part.N.	Hose I.D.			Thread	Dimensions (mm)				
	DN	Size	Inch		F	H	L	K	S
CS1212FRS90	20	12	3/4"	1 3/16"-12	54	105	48	36	
CS1216FRS90	20	12	3/4"	1 7/16"-12	54	105	49	41	
CS1616FRS90	25	16	1"	1 7/16"-12	71	127	62	41	
CS1620FRS90	25	16	1"	1 11/16"-12	71	127	62	50	
CS2020FRS90	32	20	1 1/4"	1 11/16"-12	87	153	75	50	
CS2424FRS90	40	24	1 1/2"	2"-12	105	187	90	60	

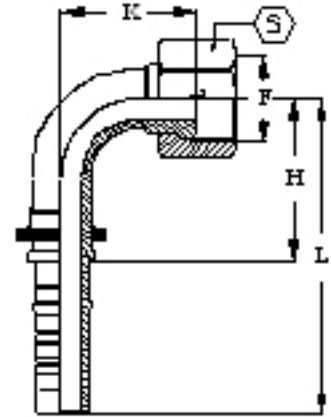

LONG DROP 90° ORFS SWEPT ELBOW - SLIP ON NUT

TIEFFE Part.N.	Hose I.D.			Thread	Dimensions (mm)				
	DN	Size	Inch		F	H	L	K	S
CS1212FRS90-K96	20	12	3/4"	1 3/16"-12	54	105	96	36	
CS1616FRS90-K114	25	16	1"	1 7/16"-12	71	127	114	41	
CS2020FRS90-K130	32	20	1 1/4"	1 11/16"-12	87	153	130	50	
CS2424FRS90-K155	40	24	1 1/2"	2"-12	105	187	155	60	

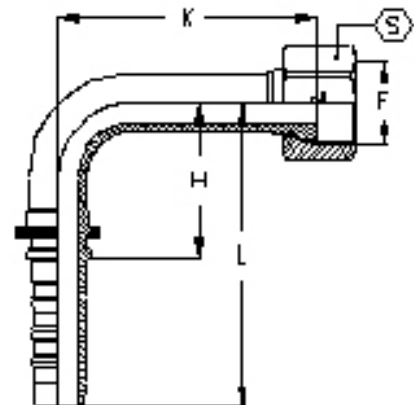

METRIC MALE - 24° CONE SEAT - HEAVY DUTY

Part.N.	Hose I.D.			Thread	Tube		Dimensions (mm)			
	DN	Size	Inch		F	mm	H	L	S	
CS12MM20S	20	12	3/4"	M30x2	20	34	85	30		
CS12MM25S	20	12	3/4"	M36x2	25	38	89	36		
CS16MM25S	25	16	1"	M36x2	25	40	97	36		
CS16MM30S	25	16	1"	M42x2	30	44	101	46		
CS20MM30S	32	20	1 1/4"	M42x2	30	47	113	46		
CS20MM38S	32	20	1 1/4"	M52x2	38	51	117	55		
CS24MM38S	40	24	1 1/2"	M52x2	38	53	135	55		

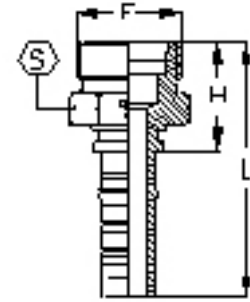

METRIC FEMALE - 24° O'RING CONE - HEAVY DUTY

Part.N.	Hose I.D.			Thread	Tube		Dimensions (mm)			
	DN	Size	Inch		F	mm	H	L	S	O'Ring
CS12FOS20S	20	12	3/4"	M30x2	20	37	88	36		16,3x2,4
CS12FOS25S	20	12	3/4"	M36x2	25	39	90	46		20,3x2,4
CS16FOS25S	25	16	1"	M36x2	25	41	97	46		22x2
CS16FOS30S	25	16	1"	M42x2	30	42	98	50		25,3x2,4
CS20FOS30S	32	20	1 1/4"	M42x2	30	43	109	50		25,3x2,4
CS20FOS38S	32	20	1 1/4"	M52x2	38	48	115	60		33,3x2,4
CS24FOS38S	40	24	1 1/2"	M52x2	38	51	133	60		33,3x2,4

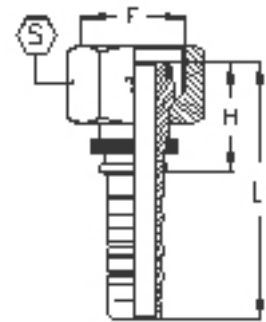

45° METRIC SWEPT ELBOW - 24° O'RING CONE - HEAVY DUTY

Part.N.	Hose I.D.			Thread	Tube		Dimensions (mm)				
	DN	Size	Inch		F	mm	H	L	K	S	O'Ring
CS12FOS20S45	20	12	3/4"	M30x2	20	65	116	27	36		16,3x2,4
CS12FOS25S45	20	12	3/4"	M36x2	25	66	117	28	46		20,3x2,4
CS16FOS25S45	25	16	1"	M36x2	25	83	140	34	46		22x2
CS16FOS30S45	25	16	1"	M42x2	30	82	138	32	50		25,3x2,4
CS20FOS30S45	32	20	1 1/4"	M42x2	30	100	166	40	50		25,3x2,4
CS20FOS38S45	32	20	1 1/4"	M52x2	38	97	164	38	60		33,3x2,4
CS24FOS38S45	40	24	1 1/2"	M52x2	38	121	203	48	60		33,3x2,4

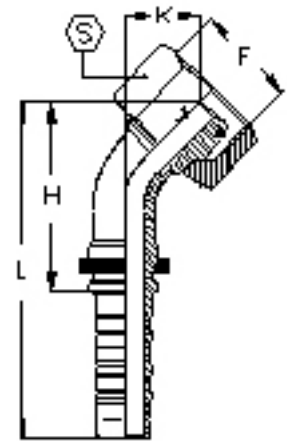

90° METRIC SWEPT ELBOW - 24° O'RING CONE - HEAVY DUTY

Part.N.	Hose I.D.			Thread	Tube		Dimensions (mm)				
	DN	Size	Inch		F	mm	H	L	K	S	O'Ring
CS12FOS20S90	20	12	3/4"	M30x2	20	55	106	55	36		16,3x2,4
CS12FOS25S90	20	12	3/4"	M36x2	25	55	106	55	46		20,3x2,4
CS16FOS25S90	25	16	1"	M36x2	25	71	128	69	46		22x2
CS16FOS30S90	25	16	1"	M42x2	30	71	128	67	50		25,3x2,4
CS20FOS30S90	32	20	1 1/4"	M42x2	30	87	154	83	50		25,3x2,4
CS20FOS38S90	32	20	1 1/4"	M52x2	38	87	154	80	60		33,3x2,4
CS24FOS38S90	40	24	1 1/2"	M52x2	38	105	188	100	60		33,3x2,4

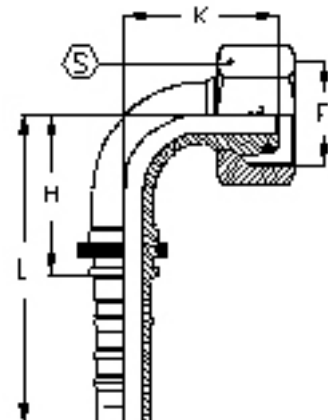

STRAIGHT FLANGE - ISO "L" SERIES - SAE CODE 61

Part.N.	Hose I.D.			Flange		Dimensions (mm)			
	DN	Size	Inch	Size	Inch	H	L	A	
CS1212FL	20	12	3/4"	12	3/4"	55	106	38.1	
CS1216FL	20	12	3/4"	16	1"	57	108	44.5	
CS1220FL	20	12	3/4"	20	1 1/4"	55	106	50.8	
CS1612FL	25	16	1"	12	3/4"	58	114.5	38.1	
CS1616FL	25	16	1"	16	1"	58	114.5	44.5	
CS1620FL	25	16	1"	20	1 1/4"	63	119.5	50.8	
CS1624FL	25	16	1"	24	1 1/2"	55	115.5	60.4	
CS2016FL	32	20	1 1/4"	16	1"	64	130.5	44.5	
CS2020FL	32	20	1 1/4"	20	1 1/4"	64	130.5	50.8	
CS2024FL	32	20	1 1/4"	24	1 1/2"	68	134.5	60.4	
CS2032FL	32	20	1 1/4"	32	2"	75	141.5	71.4	
CS2424FL	38	24	1 1/2"	24	1 1/2"	73	155.5	60.4	
CS2432FL	38	24	1 1/2"	32	2"	76	158.5	71.4	
CS3232FL	51	32	2"	32	2"	77	176.5	71.4	
CS3240FL	51	32	2"	40	2 1/2"	90	186.5	84.1	

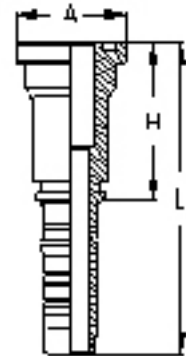

45° FLANGE ELBOW - ISO "L" SERIES - SAE CODE 61

Part.N.	Hose I.D.			Flange		Dimensions (mm)			
	DN	Size	Inch	Size	Inch	H	L	K	A
CS1212FL45	20	12	3/4"	12	3/4"	63	114	25	38.1
CS1216FL45	20	12	3/4"	16	1"	65	116	27	44.5
CS1612FL45	25	16	1"	12	3/4"	81	137	31	38.1
CS1616FL45	25	16	1"	16	1"	78	134	28	44.5
CS1620FL45	25	16	1"	20	1 1/4"	78	134	28	50.8
CS2016FL45	32	20	1 1/4"	16	1"	96	163	37	44.5
CS2020FL45	32	20	1 1/4"	20	1 1/4"	91	157	32	50.8
CS2024FL45	32	20	1 1/4"	24	1 1/2"	91	157	32	60.4
CS2424FL45	38	24	1 1/2"	24	1 1/2"	108	191	36	60.4
CS2432FL45	38	24	1 1/2"	32	2"	107	189	35	71.4
CS3232FL45	51	32	2"	32	2"	151	245	57	71.4
CS3240FL45	51	32	2"	40	2 1/2"	146	243	51	84.1

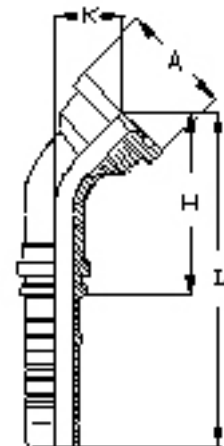

90° FLANGE ELBOW - ISO "L" SERIES - SAE CODE 61

Part.N.	Hose I.D.			Flange		Dimensions (mm)			
	DN	Size	Inch	Size	Inch	H	L	K	A
CS1212FL90	20	12	3/4"	12	3/4"	55	106	51	38.1
CS1216FL90	20	12	3/4"	16	1"	55	106	55	44.5
CS1220FL90	20	12	3/4"	20	1 1/4"	55	106	60	50.8
CS1612FL90	25	16	1"	12	3/4"	71	128	65	38.1
CS1616FL90	25	16	1"	16	1"	71	128	61	44.5
CS1620FL90	25	16	1"	20	1 1/4"	71	128	61	50.8
CS1624FL90	25	16	1"	24	1 1/2"	71	128	61	60.4
CS2016FL90	32	20	1 1/4"	16	1"	87	154	79	44.5
CS2020FL90	32	20	1 1/4"	20	1 1/4"	87	154	71	50.8
CS2024FL90	32	20	1 1/4"	24	1 1/2"	87	154	71	60.4
CS2424FL90	38	24	1 1/2"	24	1 1/2"	105	188	83	60.4
CS2432FL90	38	24	1 1/2"	32	2"	105	188	81	71.4
CS3232FL90	51	32	2"	32	2"	140	237	122	71.4
CS3240FL90	51	32	2"	40	2 1/2"	140	237	117	84.1

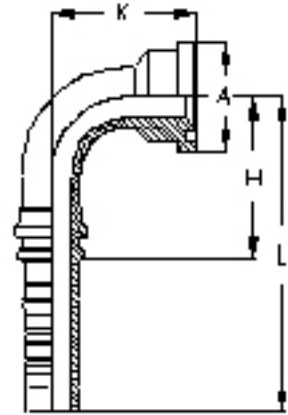

22,5° FLANGE ELBOW - ISO "L" SERIES - SAE CODE 61

Part.N.	Hose I.D.			Flange		Dimensions (mm)			
	DN	Size	Inch	Size	Inch	H	L	K	A
CS1212FL22	20	12	3/4"	12	3/4"	70	121	11	38.1
CS1216FL22	20	12	3/4"	16	1"	73	124	12	44.5
CS1616FL22	25	16	1"	16	1"	86	142	12	44.5
CS1620FL22	25	16	1"	20	1 1/4"	86	142	12	50.8
CS2020FL22	32	20	1 1/4"	20	1 1/4"	100	166	13	50.8
CS2024FL22	32	20	1 1/4"	24	1 1/2"	100	166	13	60.4
CS2424FL22	38	24	1 1/2"	24	1 1/2"	118	201	15	60.4
CS2432FL22	38	24	1 1/2"	32	2"	116	199	14	71.4
CS3232FL22	51	32	2"	32	2"	165	262	22	71.4

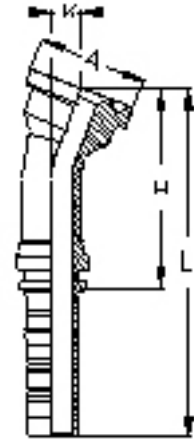

30° FLANGE ELBOW - ISO "L" SERIES - SAE CODE 61

Part.N.	Hose I.D.			Flange		Dimensions (mm)			
	DN	Size	Inch	Size	Inch	H	L	K	A
CS1212FL30	20	12	3/4"	12	3/4"	68	119	16	38.1
CS1216FL30	20	12	3/4"	16	1"	71	122	17	44.5
CS1616FL30	25	16	1"	16	1"	84	140	17	44.5
CS1620FL30	25	16	1"	20	1 1/4"	84	140	17	50.8
CS2020FL30	32	20	1 1/4"	20	1 1/4"	98	164	19	50.8
CS2024FL30	32	20	1 1/4"	24	1 1/2"	98	164	19	60.4
CS2424FL30	38	24	1 1/2"	24	1 1/2"	116	199	22	60.4
CS2432FL30	38	24	1 1/2"	32	2"	114	197	21	71.4
CS3232FL30	51	32	2"	32	2"	162	258	31	71.4

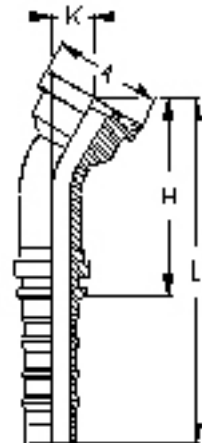

60° FLANGE ELBOW - ISO "L" SERIES - SAE CODE 61

Part.N.	Hose I.D.			Flange		Dimensions (mm)			
	DN	Size	Inch	Size	Inch	H	L	K	A
CS1212FL60	20	12	3/4"	12	3/4"	77	128	34	38.1
CS1216FL60	20	12	3/4"	16	1"	79	130	37	44.5
CS1616FL60	25	16	1"	16	1"	98	154	40	44.5
CS1620FL60	25	16	1"	20	1 1/4"	98	154	40	50.8
CS2020FL60	32	20	1 1/4"	20	1 1/4"	118	184	45	50.8
CS2024FL60	32	20	1 1/4"	24	1 1/2"	118	184	45	60.4
CS2424FL60	38	24	1 1/2"	24	1 1/2"	140	223	52	60.4
CS2432FL60	38	24	1 1/2"	32	2"	139	222	50	71.4
CS3232FL60	51	32	2"	32	2"	192	289	73	71.4

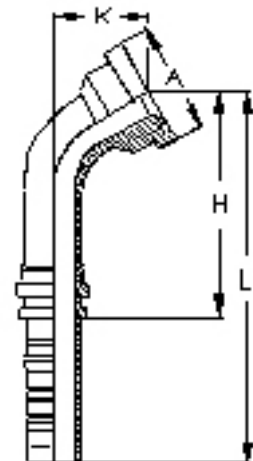

67,5° FLANGE ELBOW - ISO "L" SERIES - SAE CODE 61

Part.N.	Hose I.D.			Flange		Dimensions (mm)			
	DN	Size	Inch	Size	Inch	H	L	K	A
CS1212FL67	20	12	3/4"	12	3/4"	72	123	39	38.1
CS1216FL67	20	12	3/4"	16	1"	73	124	41	44.5
CS1616FL67	25	16	1"	16	1"	92	148	45	44.5
CS1620FL67	25	16	1"	20	1 1/4"	92	148	45	50.8
CS2020FL67	32	20	1 1/4"	20	1 1/4"	111	178	52	50.8
CS2024FL67	32	20	1 1/4"	24	1 1/2"	111	178	52	60.4
CS2424FL67	38	24	1 1/2"	24	1 1/2"	133	216	60	60.4
CS2432FL67	38	24	1 1/2"	32	2"	132	215	58	71.4
CS3232FL67	51	32	2"	32	2"	181	278	84	71.4

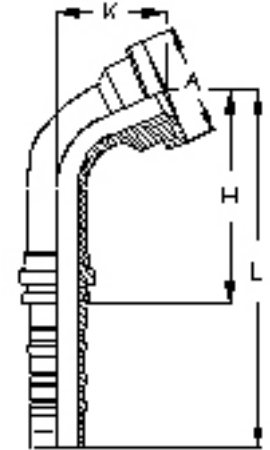

100° FLANGE ELBOW - ISO "L" SERIES - SAE CODE 61

Part.N.	Hose I.D.			Flange		Dimensions (mm)			
	DN	Size	Inch	Size	Inch	H	L	K	A
CS1212FL100	20	12	3/4"	12	3/4"	61	112	59	38.1
CS1616FL100	25	16	1"	16	1"	77	134	68	44.5

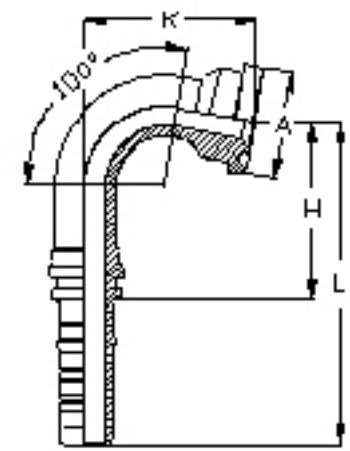

110° FLANGE ELBOW - ISO "L" SERIES - SAE CODE 61

Part.N.	Hose I.D.			Flange		Dimensions (mm)			
	DN	Size	Inch	Size	Inch	H	L	K	A
CS1212FL110	20	12	3/4"	12	3/4"	51	102	62	38.1
CS1616FL110	25	16	1"	16	1"	65	121	73	44.5
CS1620FL110	25	16	1"	20	1 1/4"	65	121	73	50.8
CS2020FL110	32	20	1 1/4"	20	1 1/4"	82	148	83	50.8
CS2024FL110	32	20	1 1/4"	24	1 1/2"	82	148	83	60.4
CS2424FL110	38	24	1 1/2"	24	1 1/2"	95	178	97	60.4
CS3232FL110	51	32	2"	32	2"	124	220	142	71.4

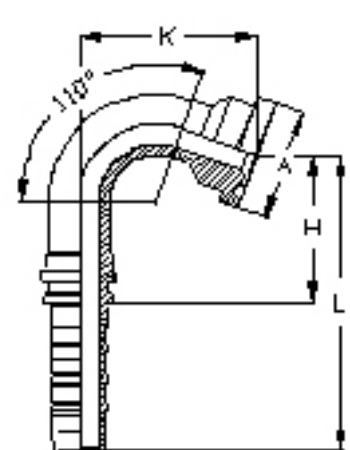

135° FLANGE ELBOW - ISO "L" SERIES - SAE CODE 61

Part.N.	Hose I.D.			Flange		Dimensions (mm)			
	DN	Size	Inch	Size	Inch	H	L	K	A
CS1212FL135	20	12	3/4"	12	3/4"	69	120	70	38.1
CS1216FL135	20	12	3/4"	16	1"	69	120	70	44.5
CS1616FL135	25	16	1"	16	1"	57	113	86	44.5

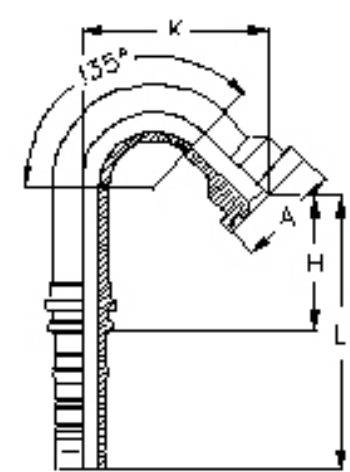

SAE Flange 90° Long Drop Elbow
O' ring seals for code 61 Flanges

90° LONG DROP FLANGE ELBOW - ISO "L" SERIES - SAE CODE 61

Part.N.	Hose I.D.			Flange		Dimensions (mm)			
	DN	Size	Inch	Size	Inch	H	L	K	A
CS1212FL90-K96	20	12	3/4"	12	3/4"	55	106	96	38.1
CS1212FL90-K127	20	12	3/4"	12	3/4"	55	106	127	38.1
CS1216FL90-K79	20	12	3/4"	16	1"	55	106	79	44.5
CS1616FL90-K118	25	16	1"	16	1"	71	128	118	44.5
CS1620FL90-K118	25	16	1"	20	1 1/4"	71	128	118	50.8
CS2020FL90-K91	32	20	1 1/4"	20	1 1/4"	87	154	91	50.8
CS2020FL90-K102	32	20	1 1/4"	20	1 1/4"	87	154	102	50.8
CS2020FL90-K112	32	20	1 1/4"	20	1 1/4"	87	154	112	50.8
CS2020FL90-K130	32	20	1 1/4"	20	1 1/4"	87	154	130	50.8
CS2020FL90-K168	32	20	1 1/4"	20	1 1/4"	87	154	168	50.8
CS2024FL90-K118	32	20	1 1/4"	24	1 1/2"	87	154	118	60.4
CS2024FL90-K130	32	20	1 1/4"	24	1 1/2"	87	154	130	60.4
CS2424FL90-K148	38	24	1 1/2"	24	1 1/2"	105	188	148	60.4
CS2424FL90-K172	38	24	1 1/2"	24	1 1/2"	105	188	172	60.4
CS2432FL90-K115	38	24	1 1/2"	32	2"	105	188	115	71.4
CS2432FL90-K172	38	24	1 1/2"	32	2"	105	188	172	71.4
CS3232FL90-K165	51	32	2"	32	2"	140	237	165	71.4
CS3232FL90-K203	51	32	2"	32	2"	140	237	203	71.4

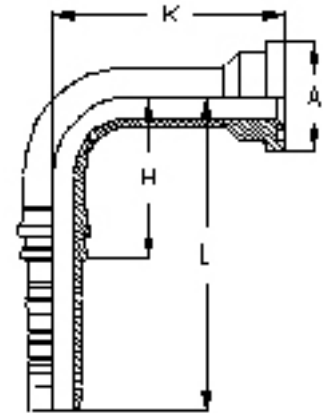

O'RING SEAL FOR ISO "L" SERIES - SAE CODE 61 FLANGES

Part.N.	Flange		Dimensions (mm)	
	Size	Inch	ISO 3601-1	SAE
OR25x3,55	12	3/4"	25x3,55	24,99x3,53
OR32,5x3,55	16	1"	32,5x3,55	32,92x3,53
OR37,5x3,55	20	1 1/4"	37,5x3,55	37,69x3,53
OR47,5x3,55	24	1 1/2"	47,5x3,55	47,22x3,53
OR56x3,55	32	2"	56x3,55	56,74x3,53



STRAIGHT FLANGE - ISO "S" SERIES - SAE CODE 62

Part.N.	Hose I.D.			Flange		Dimensions (mm)			
	DN	Size	Inch	Size	Inch	H	L	A	
CS1212FP	20	12	3/4"	12	3/4"	59	110	41.3	
CS1216FP	20	12	3/4"	16	1"	61	112	47.6	
CS1612FP	25	16	1"	12	3/4"	65	121.5	41.3	
CS1616FP	25	16	1"	16	1"	65	121.5	47.6	
CS1620FP	25	16	1"	20	1 1/4"	69	125.5	54	
CS2016FP	32	20	1 1/4"	16	1"	70	136.5	47.6	
CS2020FP	32	20	1 1/4"	20	1 1/4"	70	136.5	54	
CS2024FP	32	20	1 1/4"	24	1 1/2"	80	146.5	63.5	
CS2424FP	38	24	1 1/2"	24	1 1/2"	84	116.5	63.5	
CS2432FP	38	24	1 1/2"	32	2"	99	181.5	79.4	
CS3232FP	51	32	2"	32	2"	100	196.5	79.4	

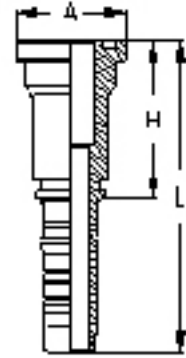

45° FLANGE ELBOW - ISO "S" SERIES - SAE CODE 62

Part.N.	Hose I.D.			Flange		Dimensions (mm)			
	DN	Size	Inch	Size	Inch	H	L	K	A
CS1212FP45	20	12	3/4"	12	3/4"	66	117	28	41.3
CS1216FP45	20	12	3/4"	16	1"	68	118	29	47.6
CS1612FP45	25	16	1"	12	3/4"	81	137	31	41.3
CS1616FP45	25	16	1"	16	1"	80	136	30	47.6
CS1620FP45	25	16	1"	20	1 1/4"	80	136	30	54
CS2016FP45	32	20	1 1/4"	16	1"	96	163	37	47.6
CS2020FP45	32	20	1 1/4"	20	1 1/4"	93	160	34	54
CS2024FP45	32	20	1 1/4"	24	1 1/2"	94	161	35	63.5
CS2424FP45	38	24	1 1/2"	24	1 1/2"	112	195	40	63.5
CS2432FP45	38	24	1 1/2"	32	2"	115	198	43	79.4
CS3232FP45	51	32	2"	32	2"	150	247	56	79.4

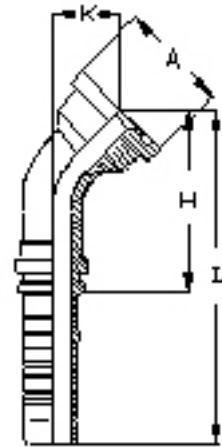

90° FLANGE ELBOW - ISO "S" SERIES - SAE CODE 62

Part.N.	Hose I.D.			Flange		Dimensions (mm)			
	DN	Size	Inch	Size	Inch	H	L	K	A
CS1212FP90	20	12	3/4"	12	3/4"	55	106	56	41.3
CS1216FP90	20	12	3/4"	16	1"	55	106	58	47.6
CS1612FP90	25	16	1"	12	3/4"	71	128	65	41.3
CS1616FP90	25	16	1"	16	1"	71	128	64	47.6
CS1620FP90	25	16	1"	20	1 1/4"	71	128	64	54
CS2016FP90	32	20	1 1/4"	16	1"	87	154	79	47.6
CS2020FP90	32	20	1 1/4"	20	1 1/4"	87	154	74	54
CS2024FP90	32	20	1 1/4"	24	1 1/2"	87	154	76	63.5
CS2424FP90	38	24	1 1/2"	24	1 1/2"	105	188	88	63.5
CS2432FP90	38	24	1 1/2"	32	2"	105	188	93	79.4
CS3232FP90	51	32	2"	32	2"	140	237	123	79.4

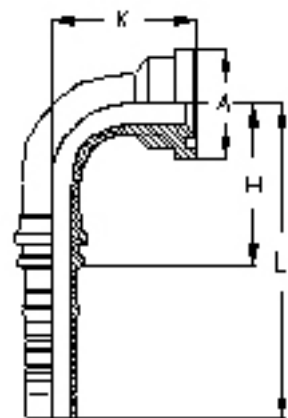

22,5° FLANGE ELBOW - ISO "S" SERIES - SAE CODE 62

	Hose I.D.			Flange		Dimensions (mm)			
	DN	Size	Inch	Size	Inch	H	L	K	A
CS1212FP22	20	12	3/4"	12	3/4"	74	125	13	41.3
CS1216FP22	20	12	3/4"	16	1"	76	127	14	47.6
CS1616FP22	25	16	1"	16	1"	89	145	13	47.6
CS1620FP22	25	16	1"	20	1 1/4"	89	145	13	54
CS2020FP22	32	20	1 1/4"	20	1 1/4"	103	169	15	54
CS2024FP22	32	20	1 1/4"	24	1 1/2"	104	171	15	63.5
CS2424FP22	38	24	1 1/2"	24	1 1/2"	123	206	17	63.5
CS2432FP22	38	24	1 1/2"	32	2"	127	210	19	79.4
CS3232FP22	51	32	2"	32	2"	166	263	24	79.4

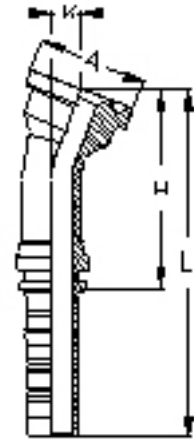

30° FLANGE ELBOW - ISO "S" SERIES - SAE CODE 62

	Hose I.D.			Flange		Dimensions (mm)			
	DN	Size	Inch	Size	Inch	H	L	K	A
CS1212FP30	20	12	3/4"	12	3/4"	72	123	18	41.3
CS1216FP30	20	12	3/4"	16	1"	74	125	19	47.6
CS1616FP30	25	16	1"	16	1"	87	143	19	47.6
CS1620FP30	25	16	1"	20	1 1/4"	87	143	19	54
CS2020FP30	32	20	1 1/4"	20	1 1/4"	100	167	20	54
CS2024FP30	32	20	1 1/4"	24	1 1/2"	102	168	21	63.5
CS2424FP30	38	24	1 1/2"	24	1 1/2"	121	203	24	63.5
CS2432FP30	38	24	1 1/2"	32	2"	124	207	26	79.4
CS3232FP30	51	32	2"	32	2"	162	259	34	79.4

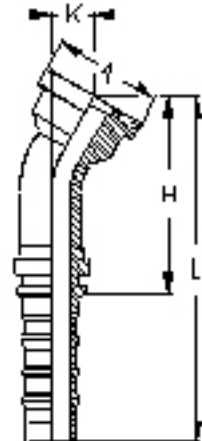

60° FLANGE ELBOW - ISO "S" SERIES - SAE CODE 62

	Hose I.D.			Flange		Dimensions (mm)			
	DN	Size	Inch	Size	Inch	H	L	K	A
CS1212FP60	20	12	3/4"	12	3/4"	79	130	38	41.3
CS1216FP60	20	12	3/4"	16	1"	80	131	40	47.6
CS1616FP60	25	16	1"	16	1"	99	155	42	47.6
CS1620FP60	25	16	1"	20	1 1/4"	99	155	42	54
CS2020FP60	32	20	1 1/4"	20	1 1/4"	119	185	47	54
CS2024FP60	32	20	1 1/4"	24	1 1/2"	120	186	49	63.5
CS2424FP60	38	24	1 1/2"	24	1 1/2"	143	225	56	63.5
CS2432FP60	38	24	1 1/2"	32	2"	145	228	60	79.4
CS3232FP60	51	32	2"	32	2"	193	289	79	79.4

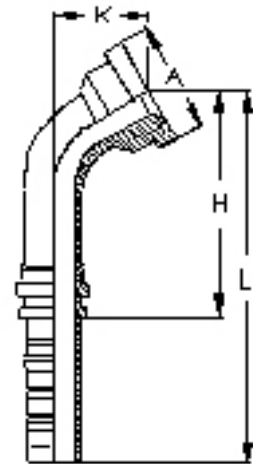

SAE Flange Elbow 67.5°

SAE Flange Elbow 90° Long Drop

O' ring seals for code 62 Flanges

67,5° FLANGE ELBOW - ISO "S" SERIES - SAE CODE 62

Part.N.	Hose I.D.			Flange		Dimensions (mm)			
	DN	Size	Inch	Size	Inch	H	L	K	A
CS1212FP67	20	12	3/4"	12	3/4"	74	125	43	41.3
CS1216FP67	20	12	3/4"	16	1"	75	126	45	47.6
CS1616FP67	25	16	1"	16	1"	93	150	48	47.6
CS1620FP67	25	16	1"	20	1 1/4"	93	150	48	54
CS2020FP67	32	20	1 1/4"	20	1 1/4"	112	179	54	54
CS2024FP67	32	20	1 1/4"	24	1 1/2"	113	180	56	63.5
CS2424FP67	38	24	1 1/2"	24	1 1/2"	135	217	65	63.5
CS2432FP67	38	24	1 1/2"	32	2"	137	219	69	79.4
CS3232FP67	51	32	2"	32	2"	182	278	90	79.4

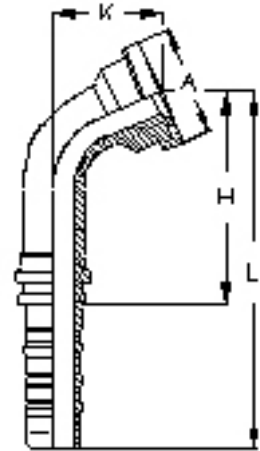

90° LONG DROP FLANGE ELBOW - ISO "S" SERIES - SAE CODE 62

Part.N.	Hose I.D.			Flange		Dimensions (mm)			
	DN	Size	Inch	Size	Inch	H	L	K	A
CS1212FP90-K100	20	12	3/4"	12	3/4"	55	106	100	41.3
CS1216FP90-K140	20	12	3/4"	16	1"	55	106	140	47.6
CS1616FP90-K120	25	16	1"	16	1"	71	128	120	47.6
CS2020FP90-K120	32	20	1 1/4"	20	1 1/4"	87	154	120	54

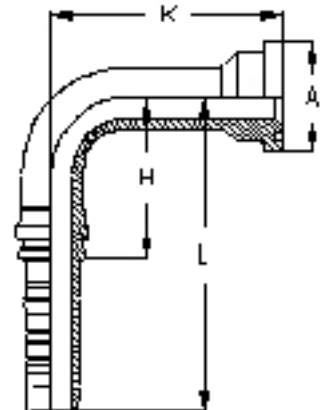

O'RING SEAL FOR ISO "S" SERIES - SAE CODE 62 FLANGES

Part.N.	Flange		Dimensions	
	Size	Inch	ISO 3601-1	SAE
OR25x3,55	12	3/4"	25x3,55	24,99x3,53
OR32,5x3,55	16	1"	32,5x3,55	32,92x3,53
OR37,5x3,55	20	1 1/4"	37,5x3,55	37,69x3,53
OR47,5x3,55	24	1 1/2"	47,5x3,55	47,22x3,53
OR56x3,55	32	2"	56x3,55	56,74x3,53



"SUPERCAT" STRAIGHT FLANGE

Part.N.	Hose I.D.			Flange		Dimensions (mm)				D'RING
	DN	Size	Inch	Size	Inch	H	L	A		
CS1212YP	20	12	3/4"	12	3/4"	84	135	41.3	DR12	
CS1216YP	20	12	3/4"	16	1"	84	135	47.6	DR16	
CS1616YP	25	16	1"	16	1"	90	146.5	47.6	DR16	
CS1620YP	25	16	1"	20	1 1/4"	90	146.5	54	DR20	
CS2020YP	32	20	1 1/4"	20	1 1/4"	88	154.4	54	DR20	
CS2024YP	32	20	1 1/4"	24	1 1/2"	88	154.5	63.5	DR24	
CS2424YP	38	24	1 1/2"	24	1 1/2"	84	166.5	63.5	DR24	
CS2432YP	38	24	1 1/2"	32	2"	110	192.5	79.4	DR32	
CS3232YP	51	32	2"	32	2"	130	226.5	79.4	DR32	

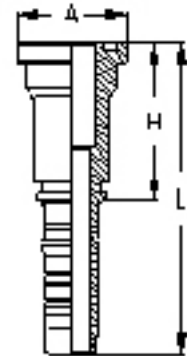

"SUPERCAT" 45° FLANGE ELBOW

Part.N.	Hose I.D.			Flange		Dimensions (mm)				
	DN	Size	Inch	Size	Inch	H	L	K	A	
CS1212YP45	20	12	3/4"	12	3/4"	72	123	34	41.3	
CS1216YP45	20	12	3/4"	16	1"	74	125	36	47.6	
CS1616YP45	25	16	1"	16	1"	86	143	36	47.6	
CS1620YP45	25	16	1"	20	1 1/4"	86	143	36	54	
CS2020YP45	32	20	1 1/4"	20	1 1/4"	96	162	36	54	
CS2024YP45	32	20	1 1/4"	24	1 1/2"	96	162	36	63.5	
CS2424YP45	38	24	1 1/2"	24	1 1/2"	114	196	41	63.5	
CS2432YP45	38	24	1 1/2"	32	2"	116	199	44	79.4	
CS3232YP45	51	32	2"	32	2"	152	250	57	79.4	

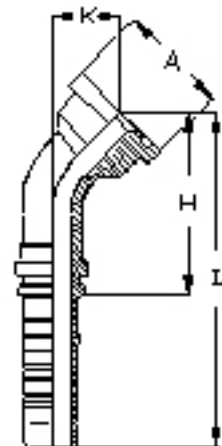

"SUPERCAT" 90° FLANGE ELBOW

Part.N.	Hose I.D.			Flange		Dimensions (mm)				
	DN	Size	Inch	Size	Inch	H	L	K	A	
CS1212YP90	20	12	3/4"	12	3/4"	55	106	64	41.3	
CS1216YP90	20	12	3/4"	16	1"	55	106	64	47.6	
CS1616YP90	25	16	1"	16	1"	71	128	73	47.6	
CS1620YP90	25	16	1"	20	1 1/4"	71	128	73	54	
CS2020YP90	32	20	1 1/4"	20	1 1/4"	87	154	77	54	
CS2024YP90	32	20	1 1/4"	24	1 1/2"	87	154	78	63.5	
CS2424YP90	38	24	1 1/2"	24	1 1/2"	105	188	90	63.5	
CS2432YP90	38	24	1 1/2"	32	2"	105	188	94	79.4	
CS3232YP90	51	32	2"	32	2"	140	237	125	79.4	

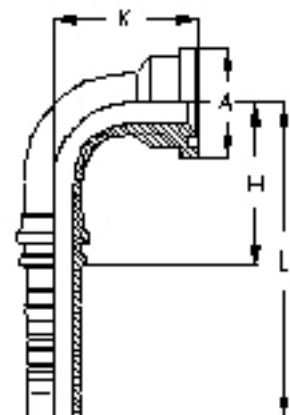

“SUPERCAT” 22,5° FLANGE ELBOW

Part.N.	Hose I.D.			Flange		Dimensions (mm)				
	DN	Size	Inch	Size	Inch	H	L	K	A	D’RING
CS1212YP22	20	12	3/4"	12	3/4"	82	133	16	41.3	DR12
CS1216YP22	20	12	3/4"	16	1"	84	135	17	47.6	DR16
CS1616YP22	25	16	1"	16	1"	97	153	17	47.6	DR16
CS1620YP22	25	16	1"	20	1 1/4"	97	153	17	54	DR20
CS2020YP22	32	20	1 1/4"	20	1 1/4"	406	172	16	54	DR20
CS2024YP22	32	20	1 1/4"	24	1 1/2"	406	174	16	63.5	DR24
CS2424YP22	38	24	1 1/2"	24	1 1/2"	125	208	18	63.5	DR24
CS2432YP22	38	24	1 1/2"	32	2"	129	211	19	79.4	DR32
CS3232YP22	51	32	2"	32	2"	168	265	25	79.4	DR32

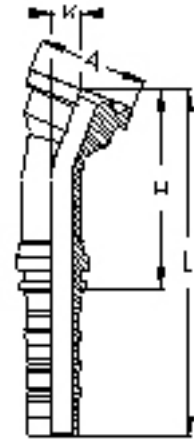

“SUPERCAT” 30° FLANGE ELBOW

Part.N.	Hose I.D.			Flange		Dimensions (mm)				
	DN	Size	Inch	Size	Inch	H	L	K	A	D’RING
CS1212YP30	20	12	3/4"	12	3/4"	79	130	22	41.3	DR12
CS1216YP30	20	12	3/4"	16	1"	82	133	23	47.6	DR16
CS1616YP30	25	16	1"	16	1"	94	151	23	47.6	DR16
CS1620YP30	25	16	1"	20	1 1/4"	94	151	23	54	DR20
CS2020YP30	32	20	1 1/4"	20	1 1/4"	103	170	22	54	DR20
CS2024YP30	32	20	1 1/4"	24	1 1/2"	104	170	23	63.5	DR24
CS2424YP30	38	24	1 1/2"	24	1 1/2"	123	205	25	63.5	DR24
CS2432YP30	38	24	1 1/2"	32	2"	126	208	27	79.4	DR32
CS3232YP30	51	32	2"	32	2"	164	264	35	79.4	DR32

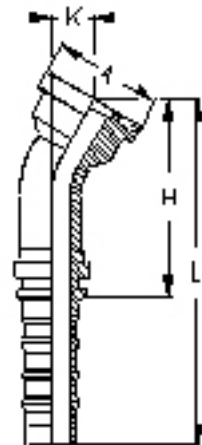

“SUPERCAT” 60° FLANGE ELBOW

Part.N.	Hose I.D.			Flange		Dimensions (mm)				
	DN	Size	Inch	Size	Inch	H	L	K	A	D’RING
CS1212YP60	20	12	3/4"	12	3/4"	83	134	45	41.3	DR12
CS1216YP60	20	12	3/4"	16	1"	85	136	48	47.6	DR16
CS1616YP60	25	16	1"	16	1"	103	160	50	47.6	DR16
CS1620YP60	25	16	1"	20	1 1/4"	103	160	50	54	DR20
CS2020YP60	32	20	1 1/4"	20	1 1/4"	121	187	50	54	DR20
CS2024YP60	32	20	1 1/4"	24	1 1/2"	121	187	51	63.5	DR24
CS2424YP60	38	24	1 1/2"	24	1 1/2"	144	226	58	63.5	DR24
CS2432YP60	38	24	1 1/2"	32	2"	146	228	61	79.4	DR32
CS3232YP60	51	32	2"	32	2"	194	290	81	79.4	DR32

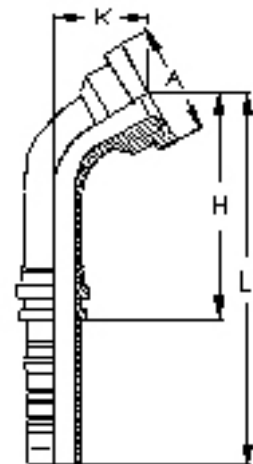

Supercat Flange Elbow 67.5°

Supercat Flange Elbow

90° Long Drop

"SUPERCAT" 67,5° FLANGE ELBOW

Part.N.	Hose I.D.			Flange		Dimensions (mm)				
	DN	Size	Inch	Size	Inch	H	L	K	A	D'RING
CS1212YP67	20	12	3/4"	12	3/4"	77	128	50	41.3	DR12
CS1216YP67	20	12	3/4"	16	1"	79	130	53	47.6	DR16
CS1616YP67	25	16	1"	16	1"	97	153	56	47.6	DR16
CS1620YP67	25	16	1"	20	1 1/4"	97	153	56	54	DR20
CS2020YP67	32	20	1 1/4"	20	1 1/4"	114	181	57	54	DR20
CS2024YP67	32	20	1 1/4"	24	1 1/2"	114	181	58	63.5	DR24
CS2424YP67	38	24	1 1/2"	24	1 1/2"	137	219	66	63.5	DR24
CS2432YP67	38	24	1 1/2"	32	2"	138	220	69	79.4	DR32
CS3232YP67	51	32	2"	32	2"	184	280	92	79.4	DR32

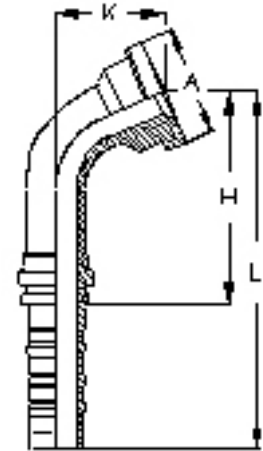

"SUPERCAT" 90° LONG DROP FLANGE ELBOW

Part.N.	Hose I.D.			Flange		Dimensions (mm)				
	DN	Size	Inch	Size	Inch	H	L	K	A	D'RING
CS1212YP90-K129	20	12	3/4"	12	3/4"	55	106	129	41.3	DR12
CS1616YP90-K132	25	16	1"	16	1"	71	128	132	47.6	DR16
CS1616YP90-K150	25	16	1"	16	1"	71	128	150	47.6	DR16
CS2020YP90-K150	32	20	1 1/4"	20	1 1/4"	87	154	150	54	DR20
CS2024YP90-K135	32	20	1 1/4"	24	1 1/2"	87	154	135	63.5	DR24
CS2424YP90-K106	38	24	1 1/2"	24	1 1/2"	105	188	106	63.5	DR24

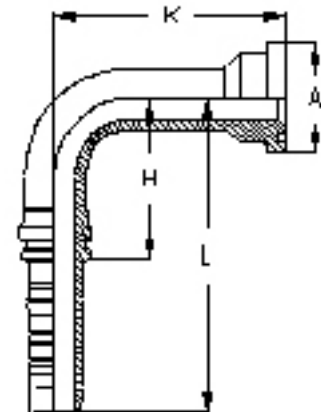

D'RING SEAL FOR "SUPERCAT" FLANGES

Part.N.	Flange		Dimensions (mm)		
	Size	Inch	D	H	S
DR12	12	3/4"	25.4	5	3.5
DR16	16	1"	31.8	5	3.5
DR20	20	1 1/4"	38.1	5	3.5
DR24	24	1 1/2"	44.5	5	3.5
DR32	32	2"	63.9	5	3.5



FEMALE SWIVEL ENDS TORQUE VALUES

SWIVEL END THREAD	DASH SIZE		NUT HEXAGON	TORQUE VALUE (Nm)		
				mm	Nominal	Min. - Max.
BSPP (GAS)	3/4"-14	12	FGO	32	115	95-135
BSPP (GAS)	1"-11	16	FGO	41	140	115-165
BSPP (GAS)	1 1/4"-11	20	FGO	50	210	140-280
BSPP (GAS)	1 1/2"-11	24	FGO	60	290	215-365
BSPP (GAS)	2"-11	32	FGO	75	400	300-500
J.I.C.	7/8"-14	10	FIC-FIS	27	69	44-94
J.I.C.	1 1/16"-12	12	FIC-FIS	32	98	63-133
J.I.C.	1 3/16"-12	14	FIC-FIS	36	118	73-163
J.I.C.	1 5/16"-12	16	FIC-FIS	41	140	90-190
J.I.C.	1 5/8"-12	20	FIC-FIS	50	210	135-285
J.I.C.	1 7/8"-12	24	FIC-FIS	60	290	215-365
J.I.C.	2 1/2"-12	32	FIC-FIS	75	400	300-500
ORFS	1 3/16"-12	12	FRC-FRS	36	90	95 max
ORFS	1 7/16"-12	16	FRC-FRS	41	125	135 max
ORFS	1 11/16"-12	20	FRC-FRS	50	170	190 max
ORFS	2"-12	24	FRC-FRS	60	200	225 max
METRIC	30x2	20S	FOS	36	135	115-155
METRIC	36x2	25S	FOS	46	166	140-192
METRIC	42x2	30S	FOS	50	240	210-270
METRIC	52x2	38S	FOS	60	330	280-380

HOSE ASSEMBLY PROCEDURE - BY CHECKING INSERT BORE COLLAPSE

- 1- Select the specified hose (A), ferrules (B) and inserts (C) listed in the latest release of hose connectors catalogue. (See Figure 1)

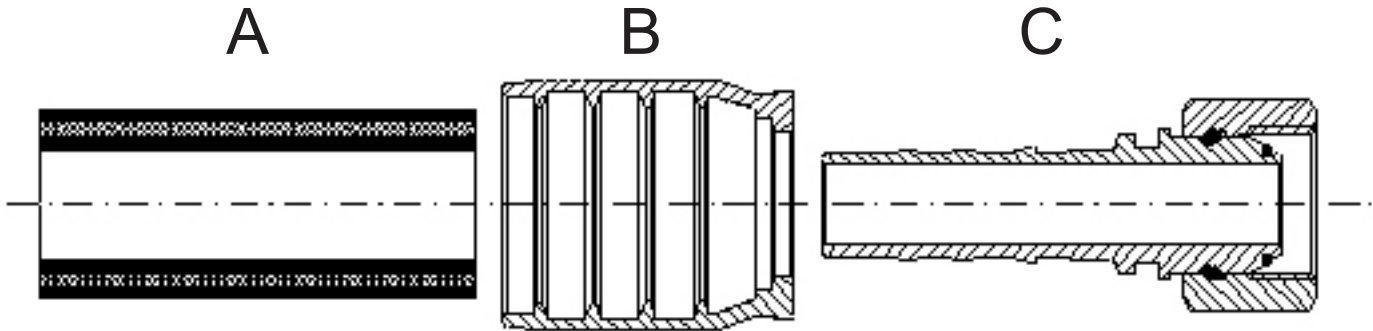

Figure 1

- 2- Cut the hose squarely using a rotary steel blade (non abrasive) to the required length.
- 3- **If skiving is required**, remove all rubber cover to the "skiving length" specified in the ASSEMBLING DATA TABLE avoiding damages to the steel wires reinforcement.
- 4- Place the ferrule fully onto the hose. Push the insert fully into the hose. Select the "COLLAPSE CONTROL MANDREL" for size and series of inserts. Insert the MANDREL into the insert bore. The "NO GO" part of the MANDREL must fully go into the insert bore. (See Figure 2). Remove the MANDREL.

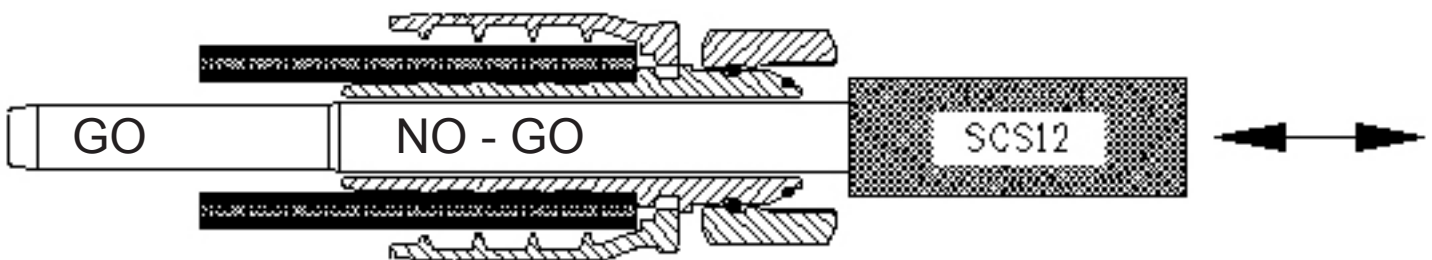

Figure 2

- 5- Crimp the ferrule to the diameter specified in the table ASSEMBLING DATA TABLE.
- 6- Inspect the crimp diameter by measuring it on each die impressions. All measurements must be taken in the center of ferrule length. All measurements must be according to the specified crimp diameters, within a tolerance +0,0/-0,2 mm.
- 7- Insert the "COLLAPSE CONTROL MANDREL".

8- If the “NO GO” part of the MANDREL stops in the bore as shown in Figure 3, crimp diameter and bore collapse are correct.

9- If the “NO GO” part of the MANDREL goes through the bore, the crimp diameter must be reduced by increments of 0,1 mm to reach the condition shown in Figure 3.

10- If the “GO” part of the MANDREL does not go through the bore, the crimp diameter must be increased (step by step) to reach the condition shown in Figure 3.

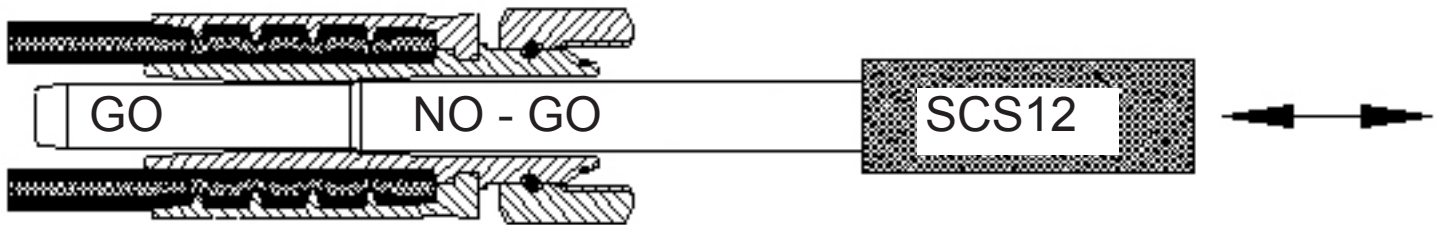

“SCS” COLLAPSE CONTROL MANDREL dimensions

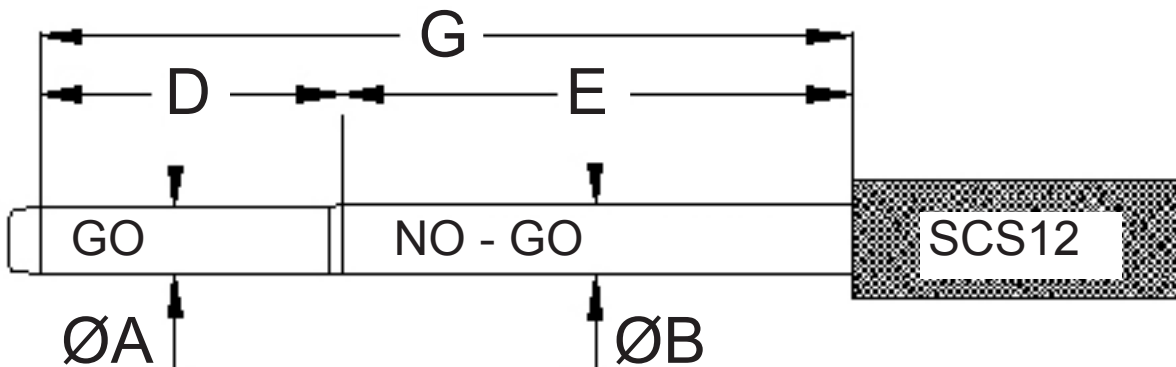

Part.N.	Hose I.D.			INSERT BORE COLLAPSE (mm)		COLLAPSE CONTROL MANDREL dimensions (mm)				
	DN	Size	Inch	minimum	maximum	ØA +0,00/-0,05	ØB +0,00/-0,05	D	E	G
SCS12	20	12	3/4"	0.70	1.40	12.60	13.30	55	115	170
SCS16	25	16	1"	0.80	1.60	17.4	18.2	60	130	190
SCS20	32	20	1 1/4"	0.90	1.80	22.7	23.6	70	150	220
SCS24	40	24	1 1/2"	1.00	2.00	28	29	85	185	270
SCS32	50	32	2"	1.20	2.40	37.6	38.8	100	230	330

NON SKIVE

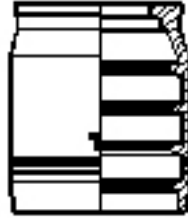

			EN8564 SP		EN456 4SH		EN856 R12 SAE100 R12			
Hose I.D.			Ferrule	Swaged diam.	Ferrule	Swaged diam.	Ferrule	Swaged diam.	Collapse control mandrel	
DN	SIZE	Inch	Part. N.	mm	Part. N.	mm	Part. N.	mm	Part. N.	
19	12	3/4"	BSN412	35.9	BSN412	35.9	BSN412	34.6	SCS12	
25	16	1"	BSN416	43.0	BSN416	42.1	BSN416	41.5	SCS16	
31	20	1 1/4"			BSN420	50.6	BSN420	51.9	SCS20	
38	24	1 1/2"			BSN424	60.0	BSN424	60.0	SCS24	
51	32	2"			BSN432	73.8	BSN432	72.5	SCS32	

			EN856 R13 SAE100 R13		SAE100 R15			
Hose I.D.			Ferrule	Swaged diam.	Ferrule	Swaged diam.	Collapse control mandrel	
DN	SIZE	Inch	Part. N.	mm	Part. N.	mm	Part. N.	
19	12	3/4"	BSN412	35.8	BSN412	35.8	SCS12	
25	16	1"	BSN416	42.2	BSN416	42.1	SCS16	
31	20	1 1/4"					SCS20	
38	24	1 1/2"					SCS24	
51	32	2"					SCS32	

SKIVE



Hose I.D.			EN8564 SP			EN456 4SH			EN856 R12 SAE100 R12			Collapse control mandrel Part. N.
DN	SIZE	Inch	Ferrule Part. N.	Skiving length mm	Swaged diam. mm	Ferrule <i>Boccola</i> Part. N.	Skiving length mm	Swaged diam. mm	Ferrule Part. N.	Skiving length mm	Swaged diam. mm	
19	12	3/4"	BSS412	41.5	32.5	BSS412	41.5	32.7	BSS412	41.5	32.1	SCS12
25	16	1"	BSS416	44.5	40.4	BSS416	44.5	40.3	BSS416	44.5	40.1	SCS16
31	20	1 1/4"	BSS620	53	50.7	BSS420	52.5	46.4	BSS420	52.5	48.0	SCS20
38	24	1 1/2"	BSS624	69	59.4	BSS424	68.5	57.4	BSS424	68.5	56.0	SCS24
51	32	2"	BSS632	78	73.6	BSS432	78	68.8	BSS432	78	69.1	SCS32

Hose I.D.			EN856 R13 SAE100 R13			SAE100 R15			Collapse control mandrel Part. N.
DN	SIZE	Inch	Ferrule Part. N.	Skiving length mm	Swaged diam. mm	Ferrule Part. N.	Skiving length mm	Swaged diam. mm	
19	12	3/4"	BSS412	41.5	33.2	BSS412	41.5	33.2	SCS12
25	16	1"	BSS416	44.5	40.8	BSS416	44.5	40.8	SCS16
31	20	1 1/4"	BSS620	53	51.3	BSS620	53	51.3	SCS20
38	24	1 1/2"	BSS624	69	60.8	BSS624	69	60.8	SCS24
51	32	2"	BSS632	78	75.7				SCS32