

**AC and DC Industrial
Motors and Drives**



About Baldor

At Baldor Electric Company, our mission is to be the best (as determined by our customers) marketers, designers and manufacturers of Industrial electric motors, drives and generators. From our home office in Fort Smith, Arkansas, we support the sales offices/warehouses that stock Baldor products worldwide, selling to distributors and original equipment manufacturers in more than 55 countries. Baldor products are available from 40 sales offices/warehouses in North America and 25 offices serving international markets.

These products are produced at 15 USA plants, and one in Bristol, UK. This brochure covers the wide range of products that are geared towards the European market for high quality industrial DC and AC motors and the majority of listed products are available from stock for immediate delivery.



- The largest stock of sub-3.7kW PM/shunt-wound DC
- 1,000+ product lines held for rapid delivery
- Cost-effective support for machine builders, JIT
- Responsive service for urgent repairs & maintenance
- Warehouse system links into world manufacturing network
- Full CE-marked range; all products comply with UL

Why Baldor?

For over 80 years, Baldor has strived to provide customers with the best value and reliability in industrial electric motors. That dedication shows in customer preference for Baldor motors. To be considered as the most preferred brand in the USA.



Baldor offers the industry's broadest line of stock products.

As a manufacturer of Industrial Electric Motors, it is critical to be able to supply the correct motor to suit varying input voltages and frequencies, as well as comply with differing standards. Recognizing this, Baldor has developed a range of 50 Hz designed motors that meet IEC Standard specifications. Save valuable time with just one call to Baldor. We offer a large range of stock motors, drives and gearboxes.



Energy-efficiency leader.

We began lowering the energy consumption of our motors in the 1920s, long before others were even talking about it. Today, our expansive line of Super-E® premium-efficient motors ranges from .75 through 1500 kW. Baldor's Super-E® line offers customers the highest overall efficiency levels in the industry.

Baldor products are available at more locations than any other brand.

Our 58 globally located offices offer immediate availability of Baldor products to thousands of distributors.

Continuous innovation to improve reliability.

Baldor leads the motor industry in applying new technologies and materials to improve motor reliability. Baldor was the first to introduce ISR® (Inverter Spike Resistant®) magnet wire, which is up to 100 times more resistant to voltage spikes. Baldor was first to use Exxon's new Polyrex® EM grease, which protects motor bearings better, providing improved lubrication life, greater shear stability, and superior resistance to washout, rust and corrosion.

Industry's shortest lead times/Flexible manufacturing.



Baldor has the industry's shortest lead times on custom motors – just ten working days. Our unique FLEX FLOW™ manufacturing process lets us produce any order in any quantity, quickly and efficiently.

Industry's best information.

Only Baldor offers customers so many choices for product information with a wide variety of catalogues and product brochures, a CD-ROM electronic catalogue, the Baldor Web site (www.baldor.com), or you may talk to a Baldor customer service person at one of our sales offices.



Index	
	Page
DC permanent magnet and shunt wound motors - IEC and NEMA frame sizes	1
Baldor's complete range of DC motors 15W to 550kW	2
IEC frame, permanent magnet DC motors	3
IEC frame washdown permanent magnet DC motors	4
IEC frame,DC Shunt wound motors	
Tacho and mounting kits for IEC permanent magnet and shunt wound motors	5
NEMA frame, permanent magnet DC motors	6
IEC DC Motors 460/360VDC (armature/field) - 6.9kW to 1187kW	
DC permanent magnet gearmotors	7
DC permanent magnet gearmotors	8
DC motor spares	
Drives for DC permanent magnet motors	9
DC Drive accessories	10
AC three phase motors - IEC and NEMA frame sizes- European stock range	11
Baldor's complete range of AC motors - US stock range	12 - 13
IEC frame, three phase AC motors	14 - 15
IEC frame, three phase AC brake motors	16
IEC frame, washdown duty AC motor range	
NEMA frame, three phase AC motors	17-18-19
Large frame AC motors to 1120kW (1500 Hp)	20
Inverter and vector duty motors	
Inverter duty gearmotors	21
Baldor AC industrial drives overview	22 -23 -24
Other Baldor products and information	25
IEC - quick reference chart	26
NEMA - quick reference chart	27
Conversion tables and useful information	28- 29

Baldor has made every effort to make this catalogue complete and accurate as of the time of printing. Since products are continuously being improved, all data is subject to change or correction. The data presented here is for general information to provide an overview of Baldor's capabilities. For specific applications, installation and operating instructions, certified dimensions, capabilities and performance data, and pricing and availability, please contact your local Baldor Sales Office.

DC permanent magnet and shunt wound motors - IEC and NEMA frame sizes

DC MOTORS

IEC metric frame motors

Baldor's Permanent Magnet DC Motors are available with B3 foot mount and a choice of IEC B5 flanges for gearbox mounting in 0.15kW to 3.7kW or B14 C-faces in 0.15kW to 1.5kW. All are designed for 180 volt input power with a 20:1 constant torque speed range.

These metric frames are protected to IP54 and are available in both TEFC and TENV styles. Designed for continuous duty and rated for thyristor control, the DC motors presented here are both permanent magnet and shunt wound types to suit a range of applications.



DC DRIVES

NEMA general purpose motors

These Baldor motors offer the same advantages as our IEC motors, but are supplied in NEMA or Imperial-size formats. This makes them ideal for use on machinery and automation manufactured in, or destined for, North America and its major export markets.

used, these totally enclosed motors feature extensive protection for long working life in harsh conditions.

DC gearmotors

Our extensive range of DC gearmotors covers both parallel shaft and right angled models with a wide choice of gear ratio's and mounting styles

AC MOTORS

Washdown

Baldor's Washdown, Paint Free Washdown and Stainless Washdown are suited for applications requiring high pressure cleaning with caustic solution. These choices allow you to select the right motor for the amount of protection required for the specific application.

They are FDA approved making them ideal for applications in food processing, external semi-protected environments, or other areas where high-pressure cleaning might be

If you cannot find a specific motor in this catalogue, then please contact your local Baldor Sales Office or Distributor who will be pleased to assist you.

AC DRIVES

Motor selection: choosing between permanent-magnet and shunt wound DC types

Permanent magnet and shunt wound motors offer similar performance, but differ in ways which can make them more suitable for particular applications, namely:

- permanent magnet motors are, in general, slightly more economic than shunt-wound motors.
- a permanent magnetic field means that motors used in metal-working environments may attract particles, which can impair cooling and damage the motor. If equipment is used where iron or steel filings are present, shunt-wound motors may be the better choice, as debris usually falls off on power-down.
- shunt wound motor speed can be controlled using the technique known as 'field weakening'. This is particularly helpful for any application requiring multiple synchronised motors, such as conveyor systems.
- shunt wound motors are usually preferable for applications involving large and rapid changes of current - or shock loads' - as these can demagnetise permanent magnets.
- permanent magnet motors have built-in magnets; shunt wound motors require an extra winding. This can have an effect on physical size. It's not possible to give a general 'rule of thumb' because the way motors are put together varies according to the rating, but if your application is space-sensitive - and does not come into any of the categories above - compare the dimensions of both types before taking a decision.

MISC.

Note: This information is for guide purposes only. Baldor will be pleased to offer advice on the most appropriate solution for particular applications.

Baldor's complete range of DC motors 15W to 550kW

Baldor manufactures a very wide range of permanent magnet and wound field DC industrial motors from 15W to 550kW. The following overview covers a selection of our full range.

All Baldor DC motors are covered by applicable UL, CSA and CE approvals and a warranty you would expect from a World-Class manufacturer.

For full details of our complete range of DC industrial motors and controls contact your local Baldor representative, see our 501 catalogue, our 501 CD-ROM or visit www.baldor.com

General purpose

In addition to the stock IEC frame models in this catalogue, Baldor have an extensive range of NEMA frame 90 or 180 VDC motors including permanent magnet designs up to 3.7kW and wound field designs through to 550kW.

Most designs allow a tachometer to be added for closed loop applications.

Applications:

- Conveyors • Extruders
- Winders • Printing presses
- Metering pumps.



Washdown

Permanent magnet DC motors are available with a choice for standard painted, stainless steel and paint-free finishes. They may be paired with our BCWD140 Washdown DC SCR control.

Applications:

- Conveyors • Packing equipment
- Food industry and other adjustable speed uses requiring high pressure hosedown



Explosion proof

Permanent Magnet DC Motors are available for 0.18kW to 1.5kW and wound field motors of 0.37kW to 2.25kW for Class I, Group D and Class II, Group F & G locations with listing by both UL and CSA.

Applications:

- Conveyors and mixers in hazardous locations • Other adjustable speed uses requiring explosion proof motors



Power motors

Baldor Power Motors are designed for fixed-speed operation from a generator or battery power supply. These are 20% compound-wound motors.

Applications:

- Cranes • Hoists • Conveyors
- Augers



Integral tachometer

Baldor's complete range of integral tachometer motors also extends to NEMA frame motors. Its compact design fits into many locations where a conventional motor won't fit.

Applications:

- Precision metering • Pumps
- Tensioning.



Lifting magnet motors

Baldor Lifting Magnet Generators provide power for lifting electro-magnets used in scrap and bulk metal handling facilities.

Horizontal motors may be driven from the diesel engine or the motors with C-faces may be coupled to the PTO drive of the crane.



IEC frame, permanent magnet DC motors

- B3 foot, B5 flange and B14 face mountings available
- TEFC and TENV options
- IP54 protection
- Continuous duty
- Class F insulation
- 20:1 speed range with constant torque
- 1750 or 3000 RPM versions
- Rated for thyristor drives
- Other voltages are available

LOW VOLTAGE
VARIANT 12 OR 24 V DC

IEC frame, 180 VDC permanent magnet, B5 flange mount, B3 base

Motor power kW	Base speed RPM	IEC Frame size	Catalogue No.	Body No.	Body style ‡	Full load A	Length 'L' mm §	Shipping Weight kg
0.15	1800	D63D	VP7424D†	135S	TENV	1.1	**	**
0.18	1750	D71D	VP3311D	3320P	TENV	1.25	321	13.6
0.18	1750	D71D	VP3411D	3410P	TEFC	1.4	330	13.6
0.25	1750	D71D	VP3316D	3327P	TENV	1.6	345	14.5
0.25	1750	D71D	VP3416D	3413P	TEFC	1.6	330	14.5
0.25	3000	D71D	VP3418D	3413P	TEFC	2.2	330	14.5
0.37	1750	D71D	VP3326D	3336P	TENV	2.5	389	14.5
0.37	1750	D71D	VP3426D	3420P	TEFC	2.5	397	20.4
0.37	3000	D71D	VP3428D	3416P	TEFC	2.5	330	16.7
0.56	1750	D80D	VP3436D	3428P	TEFC	3.7	397	21.8
0.56	3000	D80D	VP3439D	3420P	TEFC	3.6	397	20.4
0.75	1750	D80D	VP3455D	3435P	TEFC	5.0	419	24
0.75	3000	D80D	VP3458D	3428P	TEFC	5.1	397	21.8
1.1	1750	D90D	VP3575D	3536P	TEFC	7.7	440	34.5
1.1	3000	D90D	VP3468D	3432P	TEFC	8.5	419	23.6
1.5	1750	D90D	VP3585D	3548P	TEFC	9.6	481	38
1.5	3000	D90D	VP3588D	3536P	TEFC	10.0	440	34.5
2.2	1750	D112D	VP3603D*	3649P	TEFC	14.0	643	58.5
3.7	1750	D112D	VP3605D*	3681P	TEFC	24.5	643	77



IEC frame, 180 VDC permanent magnet, B14 face mount, B3 base

Motor power kW	Base speed RPM	IEC Frame size	Catalogue No.	Body No.	Body style ‡	Full load A	Length 'L' mm §	Shipping Weight kg
0.15	1800	D63C	VP7424-14†	195S	TENV	1.1	**	**
0.18	1750	D71C	VP3411-14	3410P	TEFC	1.25	310	13.6
0.25	1750	D71C	VP3416-14	3413P	TEFC	1.6	310	14
0.37	1750	D71C	VP3426-14	3420P	TEFC	2.5	348	16.8
0.37	3000	D71C	VP3428-14	3416P	TEFC	2.5	330	16.7
0.56	1750	D80C	VP3436-14	3428P	TEFC	3.7	362	19
0.56	3000	D80C	VP3439-14	3420P	TEFC	3.6	348	16.8
0.75	1750	D80C	VP3455-14	3435P	TEFC	5.0	384	23.6
0.75	3000	D80C	VP3458-14	3428P	TEFC	5.1	362	19
1.1	1750	D90C	VP3575-14	3435P	TEFC	7.7	384	23.6
1.1	3000	D80C	VP3468-14	3536P	TEFC	8.5	444	33.1
1.5	1750	D90C	VP3585-14	3548P	TEFC	9.6	475	36.7
1.5	3000	D90C	VP3588-14	3536P	TEFC	10	444	33.1



Note: Terminal box is shown on the side. Standard position on top

‡ TENV/TEFC: totally enclosed non-ventilated/totally enclosed fan-cooled

§ Length and all nominal dimensions are specified against frame size in IEC quick reference chart on page 26

† Does not conform to IP54 if base removed

* Base is non-removable

** Mechanical details available on request

Catalogue No's with shaded cells are stocked in Europe

IEC frame washdown permanent magnet DC motors

- B3 foot, B5 flange and B14 face mountings available
- Stainless steel shafts and hardware
- Corrosion resistant rotor
- Extra protection provides moisture resistant windings
- Special epoxy paint gives five times more corrosion resistance
- Withstands ASTM, B117 salt spray test for over 500 hours
- FDA approved
- Other voltages available
- Motors may be mounted in any orientation

IEC frame, 180 VDC washdown permanent magnet, TEFC

Motor power kW	Base speed RPM	IEC Frame size	Catalogue No.	Body No.	Full load A	Length 'L' mm §	Shipping Weight kg
IEC B14 face mounting							
0.25	1750	D71C	VPWD3416-14	3413P	1.6	330	14
0.37	1750	D71C	VPWD3426-14	3420P	2.5	397	16.8
0.75	1750	D80C	VPWD3455-14	3435P	5	419	19
IEC B5 flange mounting							
0.25	1750	D71D	VPWD3416D	3413P	1.7	330	14
0.37	1750	D71D	VPWD3426D	3420P	2.25	397	16.8
0.75	1750	D80D	VPWD3455D	3435P	5	419	24



These motors are identical to the B5 face- or B14 flange-mounting DC permanent magnet motors described earlier with the exception of weight, which is noted in the table.

Catalogue No's with shaded cells are stocked in Europe

IEC frame, DC shunt wound motors

- B3 foot, B5 flange and B14 face mountings available
- IP54 protection
- Continuous duty
- Class F insulation
- 20:1 speed range with constant torque
- 1750 or 3000 RPM versions
- Rated for thyristor drives

IEC frame, 180VDC Armature, 200/100 VDC field, shunt wound, TEFC

Motor power kW	Base speed RPM	IEC Frame size	Catalogue No.	Body No.	Armature full load A	Field full load A	Length 'L' mm §	Shipping Weight kg
0.18	1750	D71D	VD3426D	3413D	1.3	0.25	335	11
0.25	1750	D71D	VD3434D	3413D	1.9	0.25	335	11
0.37	1750	D71D	VD3451D	3420D	2.6	0.25	373	13.2
0.56	1750	D80D	VD3476D	3428D	3	0.3	380	16
0.75	1750	D80D	VD5318D	3535D	5	0.3	500	23.5
1.1	1750	D112D	VD6215D	3636D	7.8	0.4	437	42
1.5	1750	D112D	VD6202D	3646D	11	0.5	528	48
2.2	1750	D132D	VD7503D	7544D	14.5	0.4	569	75



§ Length and all nominal dimensions are specified against frame size in IEC quick reference chart on page 26

Catalogue No's with shaded cells are stocked in Europe

Tacho's and mounting kits for IEC permanent magnet and shunt wound motors

DC MOTORS

BTG1000 series tacho's

- Life lubricated and sealed ball bearings
- Flange or foot mounting
- Permanent magnet fields
- Silver graphite brushes for long life and best performance

This tacho may be retrofitted to Baldor permanent magnet or shunt wound motors using the appropriate kit. The tacho generator supplies a DC voltage that is proportional to the motor rpm, and the polarity is changed with the direction of rotation. This type is both suitable for regulation within a very wide range of armature speeds, and for 4-quadrant control. It also has the advantage of generating a very low ripple-voltage, which results in good regulation at low motor rpm.



DC DRIVES

BTG 1000 tacho - specification and nominal dimensions

AC MOTORS

Specification	BTG1000
Voltage Gradient (V/1000rpm)	50
RMS Ripple	8%
Maximum Speed (rpm)	5000
Maximum Current (mA)	400
Armature Resistance - ohms (at 25°C)	52
Armature Inductance (mH)	124
Armature Inertia (kg.cm ²)	1.175
Maximum Terminal Voltage (VDC)	250
Reversing Error	2%
Shaft Diameter (mm)	7.94
Mounting Spigot Diameter (mm)	63.5
Mounting Holes (mm) & PCD	4 @ 101.6
Weight approx. (kg)	2.7

AC DRIVES

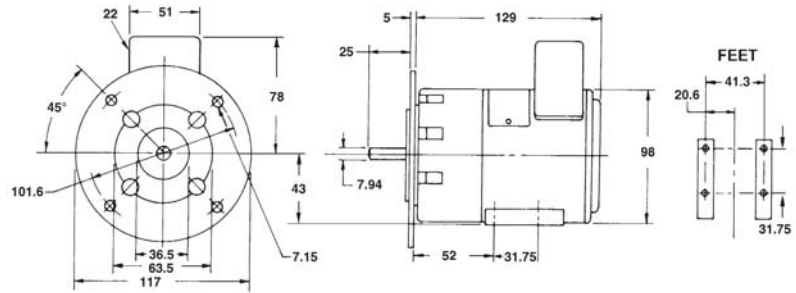

BTG 1000 tacho - mounting kits

For TEFC DC motors to 5.5kW. The kit to mount the tacho generator consists of a fan cover, shaft extension, and tacho adaptor bracket with miscellaneous hardware to connect these parts. Once the kit is in place all that is required to drive the tacho generator is a coupling between the motor shaft and tacho generator shaft. This coupling is supplied with the mounting kit. Use the adjacent cross reference of Motor Body No. to select the appropriate kit.

Motor Body No.	Tacho Catalogue No.
33xxP	TK3300
34xxD or P	TK3400
35xxD or P	TK3500
36xxD	TK3600
36xxP	TK3600PM
75xx	TK7500

Note: Catalogue No's with shaded cells are stocked in Europe

MISC.

NEMA frame, permanent magnet DC motors

- B3 foot and C face mountings available
- 1750 or 3450 RPM
- IP54 protection
- TEFC and TENV options
- Continuous duty
- Class F insulation
- 20:1 speed range with constant torque
- Rated for thyristor drives
- 90 & 180 VDC versions

NEMA frame, 90 & 180 VDC, permanent magnet

Motor power		Base speed RPM	NEMA Frame size	Catalogue No.	Body No.	Body style ‡	Voltage	Full load	Length 'C'	Shipping Weight
kW	Hp						VDC	A	inch §	kg
0.05	0.06	1725	**	AP233021	30AB-0¶	TENV	180	0.4	**	**
0.09	0.13	1725	**	AP7401*	74AP-0¶	TENV	90	1.3	**	**
0.09	0.13	1725	**	AP7421*	74AP-0¶	TENV	180	0.7	**	**
0.18	0.25	3450	**	AP7402*	74AP-0¶	TENV	90	2.6	**	**
0.18	0.25	3450	**	AP7422*	74AP-0¶	TENV	180	1.3	**	**
0.25	0.33	1750	56C	CDP3320	3327P	TENV	90	3.2	13.19	12.3
0.25	0.33	1750	56C	CDP3316	3327P	TENV	180	1.6	13.19	12.3
0.37	0.5	1750	56C	CDP3330	3336P	TENV	90	4.8	14.94	14.5
0.37	0.5	1750	56C	CDP3326	3336P	TENV	180	2.5	14.94	14.5
0.56	0.75	1750	56C	CDP3440	3428P	TEFC	90	7.0	14.59	17.3
0.56	0.75	1750	56C	CDP3436	3428P	TEFC	180	3.7	14.59	17.3
0.75	1.0	1750	56C	CDP3445	3435P	TEFC	90	10.0	15.46	20
0.75	1.0	1750	56C	CDP3455	3435P	TEFC	180	5.0	15.46	20
1.5	2.0	1750	145TC	CDP3585	3548P	TEFC	180	9.6	17.38	33.7



‡ TENV/TEFC: totally enclosed non-ventilated/totally enclosed fan-cooled

§ Length and all nominal dimensions are specified against frame size in NEMA quick reference chart on page 27

* Does not conform to IP54 if base removed

¶ Made to Imperial dimensions, but does not conform to NEMA

** Mechanical details available on request

Catalogue No's with shaded cells are stocked in Europe

IEC DC motors 460/360VDC (armature/field) - 6.9kW to 187kW

- Ratings to 550kW possible
- Low rotor moment of inertia for fast response
- Designed for full thyristor control variable speed drives
- Rated for continuous duty (S1)
- High overload capabilities
- Class 'H' Insulation
- Force ventilated
- A wide variety of options and special designs are available

Motor power kW	Nominal speed RPM	Motor frame/type	Catalogue No.	Current armature A	Current field A	Blower	Shipping Weight kg
6.9	1690	B132-219	D4206	18.3	0.97	LM3	126
11.4	1761	B132-2112	D4211	28.7	1.03	LM3	166
18.5	1709	B160-2513	D4318	46.0	1.32	LM3	315
29.4	1694	B180-2810	D4429	71.7	1.95	LM4	341
33.6	1800	B180-2813	D4433	81.0	2.0	LM4	414
40.3	1613	B200-329	D4540	97.0	1.88	LM6	417
50.7	1645	B200-329	D4550	122.6	1.88	LM6	417
74.6	1801	B200-3212	D4574	175	2.37	LM6	448
93.2#	1870	B225-368	D4693	216	2.20	LM6	487
112.0#	1810	B225-368	D46112	260	2.30	LM6	487
149.0#	1810	B225-3610	D46150	346	2.20	LM9	503
187.0#	1710	B250-4011	D46187	427	3.38	LM9	935

Motors marked with # are 4 Pole 'Stabilised Shunt Wound'. These motors must be derated by 5% if stabilised field not connected.

Stabilised shunt motors should be connected as SHUNT ONLY when used with reversing controllers.

Other motors are 4 Pole 'Straight Shunt Wound'.

All motors are – IP23 – Force Ventilated IC06. All motors are foot mounted IM1001.

Nominal dimensions are specified against frame size in IEC quick reference chart on page 26



DC permanent magnet gearmotors

- Right angle orientation with reversible output shaft
- Foot mounting
- Hardened steel worm, replaceable
- Precision hobbled bronze gear, replaceable
- Synthetic oil filled gearbox (oil mobilith SHC634)
- Internal expansion bladder on Type BA, CB and JK gearboxes to accommodate pressure build-up
- Suitable for horizontal or vertical mounting
- Reversible
- IP54 protection
- Continuous duty
- Baked Enamel Finish

JK style, 180 VDC right angle gearmotors

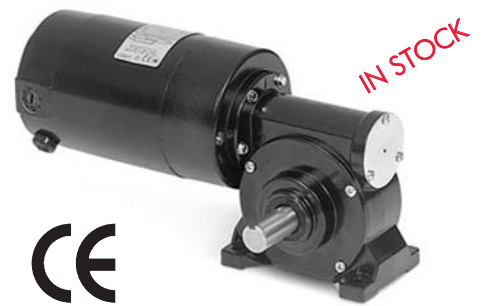
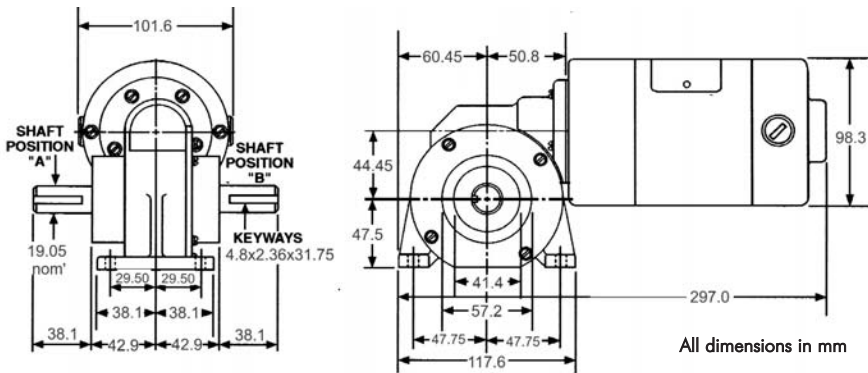

Motor input power kW	Output base speed RPM	Gear ratio	Max. safe torque Nm	Catalogue No.	Body No.	Full load current A	Armature resistance Ω	Inertia kg cm ²	Overhung load kg	Axial load kg	Weight kg
0.09	30	58:1	13.8	GP7424	74-JK-0	0.65	29	3.17	56.8	45.4	6.3
0.09	38	45:1	12.5	GP7423	74-JK-0	0.65	29	3.17	56.8	45.4	6.3
0.15	50	45:1	13.6	GP7428	74-JK-0	1.1	21	3.17	56.8	45.4	6.3
0.09	52	33:1	8.5	GP7422	74-JK-0	0.65	29	3.17	56.8	45.4	6.3
0.18	68	45:1	15.3	GP7425	74-JK-0	1.3	11	3.17	56.8	45.4	6.3
0.18	76	45:1	11.3	GP7427	74-JK-0	1.3	8	3.17	56.8	45.4	6.3
0.09	78	22.5:1	8.1	GP7421	74-JK-0	0.65	29	3.17	56.8	45.4	6.3
0.18	104	33:1	8.4	GP7426	74-JK-0	1.3	8	3.17	56.8	45.4	6.3
0.09	173	11:1	3.6	GP7420	74-JK-0	0.65	25	3.17	56.8	45.4	6.3

Catalogue No's with shaded cells are stocked in Europe

EB style, 180 VDC right angle gearmotors

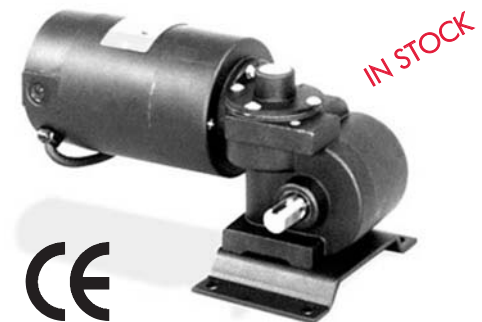
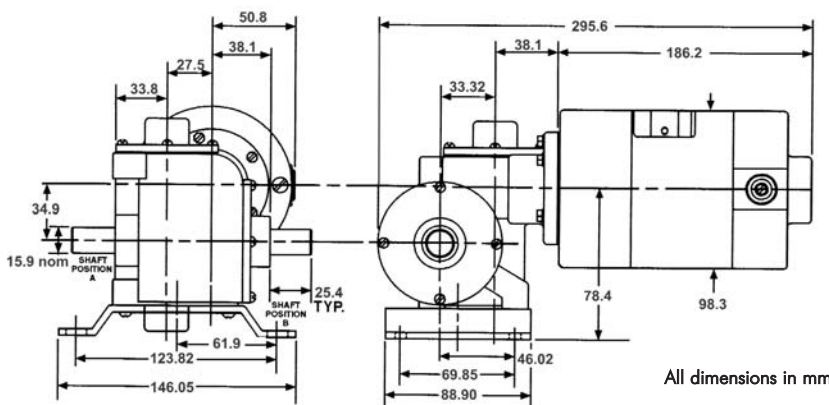

Motor input power kW	Output base speed RPM	Gear ratio	Max. safe torque Nm	Catalogue No.	Body No.	Full load current A	Armature resistance Ω	Inertia kg cm ²	Overhung load kg	Axial load kg	Weight kg
0.18	20	180:1	19.8	GP7429	74-EB-0	1.0	8.3	3.17	43.2	17.2	6.8

Catalogue No's with shaded cells are stocked in Europe

DC permanent magnet gearmotors

- Parallel shaft gearmotors
- Hardened steel helical gears, replaceable
- Diecast alloy housing & flange mount face
- Suits horizontal or vertical mounting
- Synthetic Oil Filled Gearbox (Mobilith SHC007)
- Reversible
- IP54 protection
- Continuous duty
- Baked Enamel Finish

Parallel shaft gearmotors, 180 VDC

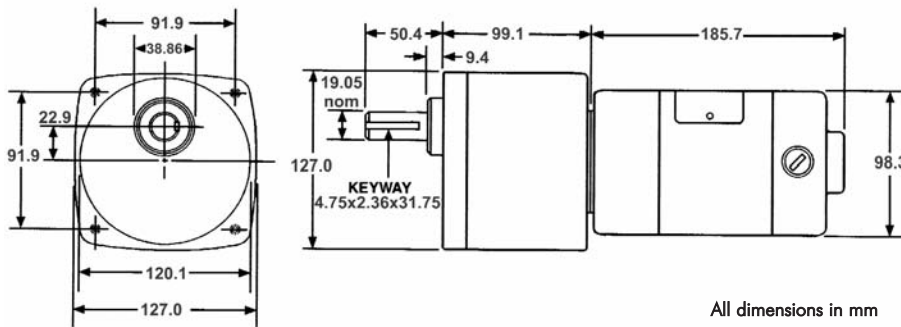

Motor input power kW	Output base speed RPM	Gear ratio	Max. safe torque Nm	Catalogue No.	Body No.	Full load current A	Armature resistance W	Inertia kg cm ²	Overhung load kg	Axial load kg	Weight kg
0.18	14	180:1	38.4	GPP7478	74-PSL-0	0.9	14	3.17	90.9	18.2	8.2
0.18	21	120:1	33.9	GPP7477	74-PSL-0	0.6	14	3.17	90.9	18.2	8.2
0.18	42	60:1	30.5	GPP7476	74-PSL-0	1.1	14	3.17	90.9	18.2	7.2
0.18	62	40:1	20.33	GPP7475	74-PSL-0	1.2	14	3.17	90.9	18.2	7.2
0.18	83	30:1	15.25	GPP7474	74-PSL-0	1.1	14	3.17	90.9	18.2	7.2
0.18	125	20:1	10.17	GPP7473	74-PSL-0	1.2	14	3.17	90.9	18.2	7.2
0.18	165	15:1	7.34	GPP7472	74-PSL-0	1.0	14	3.17	54.5	18.2	7.2
0.18	250	10:1	5.08	GPP7471	74-PSL-0	1.2	14	3.17	27.2	18.2	7.2
0.18	500	5:1	2.8	GPP7470	74-PSL-0	1.26	14	3.17	27.2	18.2	7.2
"B" Steel foot mount.				B92	Bolts to bottom of PSM gearbox						
"L" Type Mounting Bracket				LB74	To mount PSL gearmotors. Securely mounts to gear face in 90° locations for floor, wall or ceiling mount.						1.0

Catalogue No's with shaded cells are stocked in Europe

DC motors - spare brushes, capacitors and spring assemblies

When calling for spare parts, please find the part numbers you require by using the table below.

All Baldor motors in this catalogue require one brush kit except for VD7503D which requires two.



Motor No.	Brush kit	Holder	Brush caps	
AP3021	BP5066P01SP	BBR1100SP	BP4530	
AP7421—22	BP5052BN01SP	BP4529		
BTG1000	BP5060BD02	BP4517	BP4515	
CDP3316	BP5011AB01SP	Spring assy. BP5012A04SP	-	
CDP3320	BP5011T01SP			
CDP3326	BP5011AB01SP			
CDP3330	BP5011T01SP			
CDP3411—36	BP5000AW14SP			
CDP3440—45	BP5000BK08	BP5201A11SP	BP4511A01SP	
CDP3455	BP5000AW14SP			
CDP3575—85	BP5000T15SP	BP5201A14SP		
VD3426D—76D	BP5000H03SP	BP5201A10SP		BP4509A01SP
VD5318D	BP5000P07SP	BP5201A14SP		BP4511A01SP

Motor No.	Brush kit	Holder	Brush caps
VD6202D—15D	BP5001P01SP	Spring assy. BP2000A01SP	-
VD7503D	BP5002A02SP	Spring assy. BP2002A01SP	-
YP3311D—26D	BP5011AB01SP	Spring assy. BP5012A04SP	-
VP3411D—68D	BP5000AW14SP	BP5201A11SP	BP4511A01SP
VP3575D—88D	BP5000T15SP	BP5201A14SP	
VP3603D	BP5031A01SP	Spring assy. BP5030	-
VP3605D	BP5027A01SP	Spring assy. BP5028	-
VP7424D	BP5052P01	BP4529	BP4530
VPWD3426D—85D	BP5000AW14SP	BP5201A11SP	BP4511A01SP
GPP7470—79	BP5052BN01SP	BP4529	BP4530
GP233020—29	BP5060BF02SP	BP4517	BP4515
GP7420—33	BP5052BN01SP	BP4529	BP4530

Drives for DC permanent magnet motors

VersaFlex DC and Regen DC motor controls

- VersaFlex series 29 DC control provides unidirectional (single quadrant) digital control
- VersaFlex series 30 Regen control provides bidirectional (4 quadrant) regenerative control
- 220 to 500V line input (+/- 10%) and 50 or 60 Hz input for world-wide use
- Operator keypad is remote mountable to 3m for optimum ergonomic placement
- Expansion boards provide connection to RS485, Modbus and Profibus-DP networks
- UL & cUL

Baldor's VersaFlex DC controls combine digital motor control with reliable SCR power devices to provide advanced motor control.

On-board operator control allows easy programming of operating parameters and optional feedback expansion enhance drive capabilities with AC or DC tachometer or incremental encoder feedback.

Controls from 35Amp to 1580Amp continuous, include built in line contactor, control logic supply and fuses.

Other options include internally mounted blower, motor starter and communications boards.

Versaflex DC and Regen controls can be configured using Baldor's windows based program - Workbench-D.



BC 140 standalone drive & BC 142 OEM drive

- Full wave SCR control with free wheeling diode (NEMA type K)
- Field power supply allows use with shunt wound DC motors as well as permanent magnet motors
- Adjustable accel, decel, current limit, IR comp, min and max speed
- Current limit indicating LED
- 5K speed pot for speed control
- Anti-demag circuit protects PM motors and helps protect the SCR power bridge against direct shorts
- Noise rejection circuit eliminates false starts and blown SCR's
- UL and cUL recognised
- Washdown version of BC140 available from stock

BC140



IN STOCK



A ready to use single-quadrant SCR drive, provided in a compact wall-or panel-mounting NEMA1 enclosure. The drive is optimised for motors using the appropriate plug-in resistors (see table opposite). The correct line and armature fuses are provided with this resistor, ensuring safe, reliable operation. The drive may be used with 115 or 230VAC mains for 90 or 180V DC motors, and features adjustable acceleration/deceleration, MOV transient protection, IR compensation, high-speed anti-demagnetisation, and current limiting circuitry; the latter function includes an indicating LED. Approved by UL and CSA, the unit is also fully CE compliant when operated with an add-on powerline filter.

BC142



IN STOCK



This is a variant of the BC140 drive, provided in the form of a low-cost chassis-mounting module for OEM and repair applications. It offers all the circuitry features of the BC140 drive above, but can control a higher 2.25kW, 230V load when used with an optional heatsink (ref. BC143). It also includes a built-in tach feedback facility.

DC drive accessories

Plug-in resistor fuse kits for BC140 and 142

Choose the resistor needed to configure the drive by selecting the appropriate armature voltage row for your motor.

Motor power (kW)		Required resistor Ω	Motor current A (approx.)	Armature fuse A (AC)	Line fuse A (AC)	Catalogue No.
Arm. voltage 90-130VDC	Arm. voltage 180VDC					
0.007	0.015	1	-	0.5	12	BR1000
0.015	0.030	0.51	-	0.5	12	BR0510
0.025	0.050	0.35	0.33	0.5	12	BR0350
0.037	0.075	0.25	0.5	0.75	12	BR0250
0.050	0.095	0.25	0.65	1.0	12	BR0251
0.060	0.125	0.18	0.85	1.25	12	BR0180
0.125	0.18	0.1	1.3	2	12	BR0100
0.125	0.25	0.1	1.7	2.5	12	BR0101
0.18	0.37	0.05	2.5	4	12	BR0050
0.25	0.55	0.35	3.3	5	12	BR0035
0.37	0.75	0.025	5	8	12	BR0025
0.55	1.2	0.015	7.5	12***	12	BR0015SP
0.75*	1.5*	0.01	10	15	25	BR0010SP
1.2**	2.25**	0.006	15	25***	25	BR0006

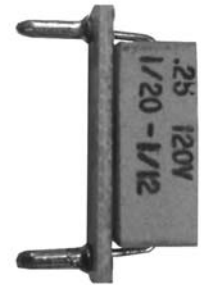

* external heatsink required

** chassis mount only with external heatsink

*** also used as AC line fuse

Catalogue No's with shaded cells are stocked in Europe

Heatsink, powerline filter and other accessories for BC140 and BC142

Drive accessory	Catalogue. No.	Weight kg (approx.)
for BC140/142		
External heatsink (for 2.25 kW load)	BC143	0.1
Fwd./brk./rev. switch	BC144	0.2
Signal isolator board	BC145	0.2
Current sensing relay overload protection	BC146	0.2
Barrier terminal board	BC147	0.1
Potentiometer kit	BC148	0.1
Knob dial kit	BC149	0.1
Powerline EMC filter	KBRF200	0.2

Dimensions for BC140 and BC142

BC140

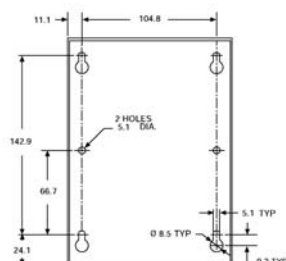
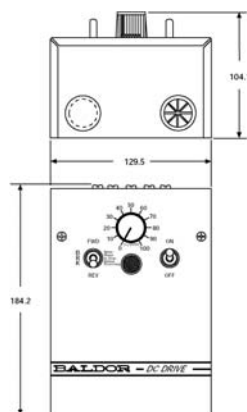

BC142 shown with optional BC143 heatsink

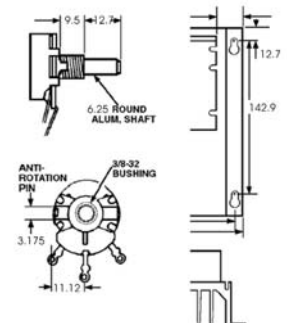
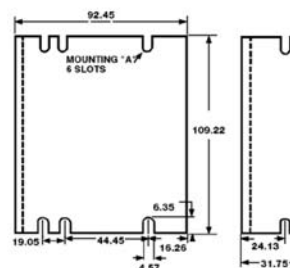

Dimensions are for reference only. All dimensions in mm

AC three phase motors - IEC and NEMA frame sizes - European stock range

Baldor produce the worlds largest range of AC three phase motors in both IEC and NEMA frame sizes

IEC frame three phase motors

Baldor Metric-E™ series IEC frame motors are designed to IEC34/IEC72 standards and offer outstanding performance and reliability with a standard totally-enclosed fan-cooled (TEFC) enclosure complying with IP55.



- Aluminium frames on sizes 63 to 112
- Cast iron frames on sizes 132 to 200
- IEC frame B5 flange, B14 face and B3 footmount versions
- Precision balance (grade N)
- Phase insulation ensures long life when used with inverters.
- Stocked motors comply with CEMEP EFF2 efficiency levels.
- Available from stock
- Brake motor variants are available.
- Comprehensive options available

IEC frame, washdown duty three phase motors

Baldor IEC frame washdown duty motors are specifically designed for applications where the motor is subjected to brutal, high pressure washdown in order to maintain a bacteria free operating environment.

For most washdown applications, the original Baldor Washdown motor, with its durable FDA approved epoxy coating, is the only solution.



- IEC frame B5 flange, B14 face and B3 footmount versions
- Designed for food processing and other applications where the motor is constantly exposed to an environment requiring high pressure wash down to maintain cleanliness
- ISR® (Inverter Spike Resistant®) 200°C magnet wire, full Class F insulation system.
- Double sealed bearings lubricated with moisture resistant grease for longer life in wet environment
- All stainless steel hardware to prevent rust for longer useful life
- Baldor "Paint Free" or "All Stainless" washdown motors provide additional durability.

General purpose NEMA frame three phase motors

Baldor's extensive line of NEMA general purpose motors are available in open drip-proof and TEFC construction in both single and three phase. Power sizes available from stock range from 1/12Hp to 600Hp. Designed for "general purpose" use means that these motors can be used in applications which include compressors, pumps, fans, conveyors, material handling, machine tools and many others.

This European catalogue covers a wide selection of motors that are primarily aimed at European manufacturers who export their machines to the USA and its markets.



- Wide range of single and three phase NEMA frame motors manufactured in the USA.
- Most Preferred USA supplier of NEMA frame motors
- Manufactured to EPC compliance certification CC010A
- ISR® (Inverter Spike Resistant®) 200°C magnet wire, full Class F insulation system
- Super-E Premium Efficiency (EFF1) versions available
- Meets UL, CSA and NEMA MG1 specifications.

Baldor's complete range of AC motors - US stock range

Baldor manufactures a very wide range of single and three phase industrial AC motors and drives from 0.18kW to over 2MW. The following overview covers a small selection of our full range.

Our full range is covered by applicable UL, CSA and CE approvals and a warranty you would expect from a World-Class manufacturer.

For full details of our complete range of industrial motors, controls and generators, contact your local Baldor representative, see our full featured 501 catalogue, our 501 CD-ROM or visit www.baldor.com

Super-E®- Premium Efficiency motors

Super-E Motors are designed to conserve energy over extended time periods. These premium efficiency designs are available in both Totally Enclosed Fan Cooled and Open Drip Proof construction. All three phase motors are Inverter Ready per NEMA Standard MG1, Part 31.4.4.2.

This means the motors in 230 and 460 volts meet NEMA's corona inception voltage requirements, and can withstand peak voltages of up to 1600 volts. Motors having premium efficiency are also available in single phase designs

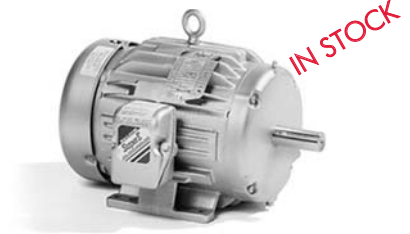

Severe duty and hostile environment motors

Chemical Processing motors are available from 1 Hp to 500 Hp. These products are especially designed for those applications requiring protection of the motors from severe environmental operating conditions.

Typical applications include:

- Petro-chemical plants
- Mines
- Foundries
- Pulp and paper plants
- Waste management facilities
- Rock
- Chemical plants.



Explosion proof motors

Baldor's Explosion-proof motors are ideal for a wide variety of applications where hazardous fumes or dust may be present. The motors are available in three phase and single phase with ratings, in stock, from 1/4 Hp to 300 Hp.



Pump motors

Our pump line of motors includes single or three phase jet pump motors, square flange motors, close-coupled pump motors, and P-Base vertical solid shaft pump motors. The motors are stocked in totally enclosed fan cooled, open drip proof, and many explosion proof ratings.

Horse powers range in size from 0.37 kW to 55kW.

Typical applications include:

- Swimming pool pumps
- Medium and high thrust in-line
- Pumps used in water treatment plants



Baldor's complete range of AC motors - US stock range

Stainless Steel and Paint Free - Washdown duty AC motors

Baldor's extensive range of washdown duty motors extends to all stainless steel and paint free models where all exterior motor surfaces, shaft and hardware are totally stainless steel.

Our Paint Free range has no exterior paint and has a specially cast iron flange/endplate on the drive end.

These special purpose motors include 200°C 'ISR' spike resistant magnet wire with moisture resistant class F insulation.

All motors are totally enclosed non-

ventilated and have excellent heat dissipation characteristics making them ideal for variable speed applications.

The range is designed for:

- Food processing
- Applications where the motor is constantly exposed to an environment requiring high pressure wash down to maintain cleanliness



Heating, ventilating and air conditioning motors

Baldor's line of heating, ventilation, and air conditioning motors are designed with dynamically balanced rotors for reduced vibration and quiet operation. The motors range in size from 0.18kW to 55kW and include heavy duty industrial designs as well as designs for commercial applications.

These applications include

- Ventilators
- Direct drive fans
- Belted fans
- Exhaust fans
- Unit heaters
- Air conditioning units
- Commercial refrigeration condensers
- Applications involving variable torque electronic controls used to conserve electricity.



Commercial duty motors

The new Baldor commercial duty motor line brings Baldor's reputation for high quality designs to commercial applications with a cost-effective offering. This definite purpose product line is designed for certain applications requiring NEMA 48 and 56 motors rated between 1/4Hp to 1 Hp, in both single and three phase ratings.

Typical applications include:

- Jet pumps
- Heating and cooling motors
- Ventilation motors
- Air conditioning motors
- Blowers
- Direct drive fans
- Condenser fans
- Pedestal fans.



Other Baldor motors include:

- 200V and 575V motors
- Farm duty motors
- F-2 Mounting motors
- Brake motors
- Custom motors
- Elevator motors

IEC frame, three phase AC motors

- B3 foot, B5 flange and B14 face mountings available
- Ratings from 0.07 to 37 kW
- 2, 4, 6 and 8 pole
- 3 phase, 230-400V 50Hz / 277-480V 60Hz
- IEC Frame sizes 63 to 200
- Efficiency class EFF2
- IP55 enclosure



Metric-E - 2-pole, 3000 RPM

Catalogue No. <small>(B3 Foot Mount—see note on page 16 for B5 & B14 mount)</small>	kW	Motor type	F.L. RPM	Nominal efficiency			Power factor			Current 400V	Torque			Rotor inertia kgm ²	Length 'L' mm §	Weight kg
				Eff @ 1/2	Eff @ 3/4	Eff @ F.L.	P.F. @ 1/2	P.F. @ 3/4	P.F. @ F.L.		FLT Nm	POT Nm	LRT Nm			
MM50612-57	0.18	63 A2	2800	56.0	60.0	61.1	0.50	0.58	0.71	0.6	0.614	2.10	2.10	0.00016	220	3.6
MM50622-57	0.25	63 B2	2800	49.0	60.0	63.4	0.55	0.64	0.76	0.75	0.853	2.20	2.20	0.00016	220	3.9
MM50632-57	0.37	63 C2	2760	52.0	63.0	66.8	0.55	0.64	0.80	1.0	1.281	3.20	3.20	0.00020	220	4.1
MM50712-57	0.37	71 A2	2810	59.0	64.0	65.3	0.53	0.67	0.78	1.05	1.258	3.40	3.10	0.00032	253	5
MM50722-57	0.55	71 B2	2810	62.0	67.5	68.5	0.57	0.69	0.80	1.45	1.870	5.50	5.10	0.00041	253	6
MM50812-57	0.75	80 A2	2800	69.4	72.0	74.1	0.73	0.84	0.86	1.7	2.559	6.30	6.30	0.00064	282	9
MM50822-57	1.1	80 B2	2800	75.1	77.6	77.0	0.72	0.81	0.86	2.4	3.753	11.3	11.2	0.00083	282	10
MM50912-57	1.5	90 SA2	2850	78.1	80.2	78.8	0.73	0.82	0.86	3.2	5.028	12.5	11.0	0.0013	305	11.5
MM50922-57	2.2	90 LA2	2840	77.9	81.9	81.6	0.74	0.83	0.86	4.5	7.401	20.3	18.7	0.0017	330	15
MM51012-57	3	100 LA2	2860	81.4	83.0	82.8	0.66	0.77	0.84	6.2	10.02	24.0	23.3	0.0030	373	21
MM51112-57	4	112 MB2	2880	83.6	84.9	84.4	0.77	0.82	0.84	8.1	13.27	36.5	34.0	0.0051	390	31
MM51312-58	5.5	132 SA2	2890	86.0	86.0	85.8	0.72	0.82	0.86	10.8	18.18	58	51	0.0097	468	38.5
MM51322-58	7.5	132 SB2	2890	87.0	87.5	87.3	0.72	0.82	0.85	14.6	24.79	79	70	0.0126	468	44.5
MM51612-58	11	160 MA2	2920	87.0	87.3	86.5	0.91	0.93	0.94	19.5	35.99	108	108	0.0422	602	116
MM51622-58	15	160 MB2	2930	87.0	88.6	88.5	0.90	0.92	0.93	26.3	48.91	158	158	0.0422	602	116
MM51632-58	18.5	160 LA2	2930	87.2	88.8	88.7	0.90	0.92	0.93	32.4	60.32	190	190	0.0501	646	133
MM51812-58	22	180 LA2	2950	89.6	91.0	91.6	0.91	0.93	0.95	36.7	71.25	203	195	0.0855	706	186
MM52012-58	30	200 LA2	2940	89.0	91.0	89.2	0.89	0.93	0.94	52.0	97.49	285	280	0.0890	731	200
MM52022-58	37	200 LB2	2940	89.0	91.0	89.7	0.89	0.92	0.93	64.1	120.2	360	350	0.1002	731	214

Metric-E - 4-pole, 1500 RPM

Catalogue No. <small>(B3 Foot Mount—see note on page 16 for B5 & B14 mount)</small>	kW	Motor type	F.L. RPM	Nominal efficiency			Power factor			Current 400V	Torque			Rotor inertia kgm ²	Length 'L' mm §	Weight kg
				Eff @ 1/2	Eff @ 3/4	Eff @ F.L.	P.F. @ 1/2	P.F. @ 3/4	P.F. @ F.L.		FLT Nm	POT Nm	LRT Nm			
MM50614-57	0.12	63 A4	1330	47.0	55.0	55.1	0.47	0.55	0.70	0.45	0.862	2.10	2.10	0.00018	220	3.4
MM50624-57	0.18	63 B4	1350	50.0	56.0	61.1	0.44	0.56	0.71	0.6	1.274	3.60	3.60	0.00026	220	4.1
MM50634-57	0.22	63 C4	1350	59.5	66.2	64.2	0.37	0.52	0.66	0.75	1.557	4.40	4.40	0.00030	220	4.5
MM50644-57	0.30	63 D4	1350	63.0	69.0	64.5	0.37	0.50	0.64	1.05	2.123	6.60	6.60	0.00034	220	4.8
MM50714-57	0.25	71 A4	1400	50.0	62.6	69.5	0.42	0.57	0.65	0.8	1.706	4.30	4.30	0.00066	253	5.0
MM50724-57	0.37	71 B4	1400	65.3	69.0	71.5	0.45	0.57	0.68	1.1	2.525	6.70	6.70	0.00066	253	6.0
MM50734-57	0.55	71 C4	1360	65.0	69.2	68.8	0.46	0.61	0.70	1.65	3.864	9.20	9.20	0.00081	253	7.0
MM50744-57	0.65	71 D4	1350	68.0	72.0	68.1	0.45	0.60	0.69	2.0	4.600	10.0	8.9	0.00091	253	7.5
MM50814-57	0.55	80 A4	1400	62.4	68.9	67.8	0.45	0.57	0.69	1.7	3.753	9.00	7.80	0.00101	282	9.0
MM50824-57	0.75	80 B4	1400	70.5	72.5	73.5	0.45	0.58	0.67	2.2	5.118	13.0	12.5	0.00133	282	10.0
MM50834-57	0.9	80 C4	1390	72.2	74.5	74.7	0.40	0.49	0.67	2.6	6.186	17.6	17.6	0.00149	282	11.0
MM50914-57	1.1	90 SA4	1400	75.0	77.5	76.5	0.55	0.68	0.77	2.7	7.507	18.8	17.0	0.0021	305	11.5
MM50924-57	1.5	90 LA4	1400	79.2	81.2	80.3	0.51	0.66	0.75	3.6	10.24	28.0	27.2	0.0029	330	14.0
MM50934-57	1.85	90 LB4	1400	80.1	81.0	80.7	0.52	0.66	0.77	4.3	12.63	37.5	33.5	0.0034	330	15.5
MM51014-57	2.2	100 LA4	1415	80.0	81.8	81.5	0.60	0.73	0.78	5.0	14.85	37.0	35.8	0.0047	373	19
MM51024-57	3	100 LB4	1415	81.0	83.5	83.0	0.59	0.72	0.80	6.5	20.26	62.0	57.9	0.0062	373	25
MM51114-58	4	112 MB4	1410	86.0	86.2	84.8	0.66	0.78	0.84	8.1	27.10	73.0	70.0	0.0108	390	32
MM51314-58	5.5	132 SB4	1430	85.5	86.0	85.8	0.70	0.77	0.82	11.3	36.75	87.0	87.0	0.0213	468	44.5
MM51324-58	7.5	132 MA4	1435	86.8	87.5	87.2	0.70	0.80	0.84	14.8	49.93	125	125	0.0287	506	55
MM51614-58	11	160 MB4	1460	89.2	88.8	88.5	0.71	0.81	0.85	21.2	71.98	210	210	0.0566	602	116
MM51624-58	15	160 LA4	1460	86.8	89.3	87.5	0.74	0.83	0.87	28.5	98.16	265	265	0.0754	646	133
MM51814-58	18.5	180 LA4	1460	88.5	89.4	89.1	0.82	0.87	0.89	33.7	121.1	350	350	0.1388	706	186
MM51824-58	22	180 LB4	1460	91.3	92.0	89.5	0.71	0.80	0.85	41.8	144.0	360	360	0.1388	706	187
MM52014-58	30	200 LB4	1455	89.6	89.3	88.2	0.75	0.83	0.87	56.5	197.0	490	490	0.1623	731	214

Catalogue No's for B3 motors with shaded cells are stocked in Europe

Please check stock availability for B5 and B14 motors with your local Baldor office

IEC frame, three phase AC motors

Metric-E - 6-pole, 1000 RPM

Catalogue No. <small>(B3 Foot Mount—see note below for B5 & B14 mount)</small>	kW	Motor type	F.L. RPM	Nominal efficiency			Power factor			Current 400V	Torque			Rotor inertia kgm ²	Length 'L' mm §	Weight kg
				Eff @ 1/2	Eff @ 3/4	Eff @ F.L.	P.F. @ 1/2	P.F. @ 3/4	P.F. @ F.L.		FLT Nm	POT Nm	LRT Nm			
MM50616-57	0.09	63 C6	890	30.6	38.5	46.4	0.41	0.49	0.56	0.5	0.966	2.60	2.60	0.00030	220	4.5
MM50626-57	0.12	63 D6	870	30.0	41.0	48.2	0.36	0.46	0.60	0.6	1.318	3.10	3.10	0.00034	220	4.8
MM50716-57	0.18	71 A6	875	54.2	59.8	61.1	0.49	0.62	0.71	0.6	1.965	3.20	2.90	0.00082	253	5.5
MM50726-57	0.25	71 B6	900	58.7	64.1	63.6	0.50	0.61	0.71	0.8	2.654	4.60	4.50	0.00107	253	6.0
MM50816-57	0.37	80 A6	910	56.4	64.0	63.8	0.40	0.52	0.67	1.25	3.885	10.5	10.0	0.00197	282	9.0
MM50826-57	0.55	80 B6	900	62.6	66.4	64.9	0.45	0.59	0.68	1.8	5.839	13.2	12.8	0.00252	282	10.0
MM50916-57	0.75	90 SA6	910	66.3	69.8	69.3	0.44	0.58	0.68	2.3	7.874	16.1	16.1	0.00339	305	11.0
MM50926-57	1.1	90 LA6	910	70.1	73.3	72.1	0.42	0.56	0.68	3.2	11.55	25.9	25.9	0.00452	330	13.5
MM51016-57	1.5	100 LA6	930	76.7	78.2	77.1	0.47	0.60	0.71	3.9	15.41	35.3	35.3	0.0086	373	20.5
MM51026-57	1.85	100 LB6	920	74.4	78.2	78.0	0.42	0.57	0.68	5.0	19.21	50.0	49.4	0.0104	373	25
MM51116-58	2.2	112 MB6	945	75.1	80.3	77.4	0.63	0.72	0.79	5.2	22.24	55.0	38.0	0.0167	390	32
MM51316-58	3	132 SB6	960	81.5	83.5	83.7	0.62	0.74	0.78	6.6	29.86	91.0	75.0	0.0288	468	44.5
MM51326-58	4	132 MA6	960	81.8	83.8	84.0	0.63	0.75	0.81	8.5	39.81	110	90	0.0344	506	55
MM51336-58	5.5	132 MB6	960	82.0	84.0	83.3	0.65	0.77	0.83	11.5	54.74	133	109	0.0411	506	66
MM51616-58	7.5	160 MB6	965	86.2	86.6	86.3	0.58	0.72	0.79	15.9	74.25	210	160	0.0845	602	112
MM51626-58	9.2	160 LA6	970	88.1	89.6	89.7	0.62	0.74	0.81	18.3	90.62	270	205	0.1145	646	133
MM51636-58	11	160 LB6	970	86.7	90.0	87.8	0.60	0.72	0.80	22.7	108.3	340	270	0.1145	646	145
MM51816-58	15	180 LB6	970	85.7	89.3	87.8	0.67	0.78	0.84	29.4	147.7	460	340	0.1740	706	187
MM52016-58	18.5	200 LA6	970	85.4	85.7	85.7	0.69	0.77	0.82	38.1	182.2	520	400	0.2029	731	200
MM52026-58	22	200 LB6	965	85.9	86.0	86.0	0.70	0.79	0.85	43.5	217.8	540	420	0.2029	731	214

Metric-E - 8-pole, 750 RPM

Catalogue No. <small>(B3 Foot Mount—see note below for B5 & B14 mount)</small>	kW	Motor type	F.L. RPM	Nominal efficiency			Power factor			Current 400V	Torque			Rotor inertia kgm ²	Length 'L' mm §	Weight kg
				Eff @ 1/2	Eff @ 3/4	Eff @ F.L.	P.F. @ 1/2	P.F. @ 3/4	P.F. @ F.L.		FLT Nm	POT Nm	LRT Nm			
MM50618-57	0.07	63 D8	650	20.5	26.0	30.0	0.46	0.51	0.62	0.55	1.029	2.50	2.50	0.00034	220	4.8
MM50718-57	0.08	71 A8	660	30.0	39.0	42.0	0.40	0.47	0.53	0.6	1.158	2.10	2.10	0.00051	253	5.5
MM50728-57	0.11	71 B8	660	30.0	37.0	40.0	0.42	0.49	0.55	0.8	1.592	2.80	2.80	0.00066	253	6
MM50818-57	0.18	80 A8	675	38.3	45.5	50.0	0.43	0.52	0.59	0.95	2.548	5.30	4.90	0.00197	282	9
MM50828-57	0.25	80 B8	675	43.0	50.0	52.0	0.41	0.51	0.62	1.25	3.539	7.00	7.00	0.00252	282	10
MM50918-57	0.37	90 SA8	680	51.0	57.4	59.4	0.38	0.49	0.60	1.5	5.199	11.6	10.6	0.00341	305	11
MM50928-57	0.55	90 LA8	690	52.0	59.0	64.5	0.37	0.46	0.56	2.2	7.616	16.0	15.8	0.00452	330	13.5
MM51018-57	0.75	100 LA8	700	62.2	67.7	68.0	0.37	0.47	0.58	2.75	10.24	20.6	20.6	0.0086	373	22
MM51028-57	1.1	100 LB8	700	60.0	66.6	65.7	0.36	0.46	0.59	4.1	15.01	40.0	38.3	0.0104	373	26
MM51118-58	1.5	112 MB8	705	66.8	69.2	73.7	0.38	0.50	0.60	4.9	20.33	55.0	40.3	0.0167	390	32
MM51318-58	2.2	132 SB8	720	69.0	76.0	78.0	0.52	0.64	0.72	5.3	29.20	72.0	58.0	0.0310	468	47
MM51328-58	3	132 MB8	720	70.0	78.0	80.0	0.53	0.65	0.72	7.3	39.80	99.0	79.0	0.0400	506	65
MM51618-58	4	160 MA8	725	76.1	81.1	83.1	0.51	0.64	0.72	9.6	52.71	150	120	0.0950	602	116
MM51628-58	5.5	160 MB8	725	77.4	83.3	83.5	0.49	0.61	0.70	13.6	72.48	210	170	0.0950	602	120
MM51638-58	7.5	160 LA8	725	77.5	83.5	83.8	0.49	0.61	0.70	18.6	98.84	290	230	0.1287	646	135
MM51818-58	11	180 LB8	730	82.3	85.4	85.2	0.50	0.62	0.72	25.9	144.0	380	280	0.2151	706	194
MM52018-58	15	200 LA8	730	83.5	85.4	85.8	0.56	0.69	0.77	32.8	196.3	460	370	0.2595	731	214

Notes for ordering B5 and B14 motors:

For B5 flange mount motor, replace first 2 letters (MM) of the catalogue number with MVM and add a D before the hyphen (-). MM51812-58 becomes MVM51812D-58

For B14 face mount motor, replace first 2 letters (MM) of the catalogue number with MVM and add a C before the hyphen (-). MM50818-57 becomes MVM50818C-57

B14 face mount motors are only available up to frame size 132

For pricing of B5 and B14 motor types, consult your local Baldor office

§ : Length and all nominal dimensions are specified against frame size in IEC quick reference chart on page 26

IEC frame, three phase AC brake motors 90W...45kW

- Brake motors are available in 2, 4, 6 and 8 pole designs
- B3 foot, B5 flange and B14 face mountings available
- BA series - AC powered braking assembly
- BM series - DC powered braking assembly
- Dual speed also available
- No axial sliding of shaft - equal braking torque in both directions
- Double brake models are available on request



Metric-E brake motors - 4-pole, 1500 rpm

Motor Frame	BM series - DC powered braking		BA series - AC powered braking	
	Max. braking torque Nm	Brake reaction time (normal/quick) ms	Max. braking torque Nm	Brake reaction time ms
56	2	70/30	N/A	N/A
63	5	70/30	N/A	N/A
71	9	80/20	14	7
80	15	80/20	18	7
90	30	80/20	38	7
100	42	80/30	50	9
112	60	80/30	80	9
132	120	85/30	150	12
160	155	85/30	190	12
180	180	90/30	300	12
200	180	90/30	300	12

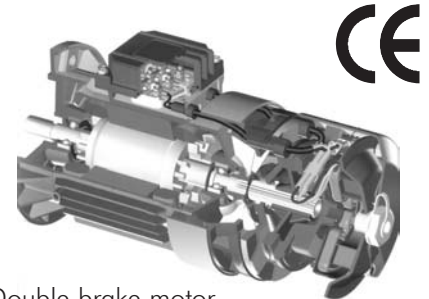

Double brake motor

Specifications for Metric-E brake motors are as our standard Metric-E motors on pages 14 and 15. For complete details contact your Baldor representative.

Certain models available from European stock - call for details

IEC frame, washdown duty AC motor range

- B3 foot, B5 flange and B14 face mountings available
- Stainless steel shafts and hardware
- Corrosion resistant rotor
- Extra protection provides moisture resistant windings
- Special epoxy paint gives five times more corrosion resistance
- Withstands ASTM, B117 salt spray test for over 500 hours
- FDA approved
- Motors may be mounted in any orientation

COMPLETE STAINLESS STEEL MOTORS AVAILABLE,
Call for details

IEC frame, washdown duty motors

Catalogue No. <small>(B3 Foot Mount—see notes below for B5 & B14 mount)</small>	Motor power kW	Base speed RPM	Motor type	Voltage (50Hz) VAC	Nominal length § mm	Weight kg (approx'.)
WDMM3538-50	0.37	1425	D71	230-400 volt 3 Phase	281	15
WDMM3546-50	0.75	1440	D80	230-400 volt 3 Phase	308	19
WDMM3554-50	1.1	1440	D90	230-400 volt 3 Phase	329	23
WDMM3558-50	1.5	1425	D90	230-400 volt 3 Phase	339	21
WDMM3611-50	2.2	1425	D100	230-400 volt 3 Phase	420	32
WDMM3615-50	4	1450	D112	400 volt 3 Phase	406	37
WDMM3710-50	5.5	1460	D132	400 volt 3 Phase	455	58
WDMM3714-50	7.5	1450	D132	400 volt 3 Phase	484	63



B3 Foot

§ Length and all nominal dimensions are specified against frame size in IEC quick reference chart on page 26

Notes for ordering B5 and B14 motors:

For B5 flange mount motor, replace the third and fourth letters (MM) of the catalogue number with MVM and add a D before the hyphen (-).
WDMM3538-50 becomes WDMVM3538D-50

For B14 flange mount motor, replace the third and fourth letters (MM) of the catalogue number with MVM and add a C before the hyphen (-).
WDMM3538-50 becomes WDMVM3538C-50

Catalogue No's with shaded cells are stocked in Europe, B5 and B14 variants are also stocked.

NEMA frame, three phase AC motors

- B3 foot, B5 (D) flange and C face mountings available
- Most preferred USA supplier of NEMA frame motors
- EPAAct compliance certification CC010A
- ISR® (Inverter Spike Resistant®) magnet wire, full Class F insulation system
- Meets UL, CSA and NEMA MG1 specifications.
- IP54 protection



B3 - 2 pole 3 phase 230/460V 60Hz 1.15 Service Factor TEFC

Catalogue No.	Hp	RPM at 60hz	Voltage	Nema Frame	Dim 'C' §	Baldor Type	Frame	FL Efficiency	Weight kg
M3457	1/3	3450	230/460	48	10.73	3410M	48	72	9.0
M3460	1/2	3450	230/460	48	12.25	3410M	48	68	8.6
M3541	3/4	3450	230/460	56	11.35	3413M	56	74	9.5
M3545	1	3450	230/460	56	11.35	3416M	56	75.5	10.5
M3550T	1.5	3450	230/460	143T	12.31	3520M	143	82.5	16.8
M3555T	2	3450	230/460	145T	13.31	3526M	145	84	19.5
M3559T	3	3460	230/460	145T	14.91	3542M	145	85.5	28.2
M3613T	5	3450	230/460	184T	16.55	3630M	184	87.5	33.2
M3616T	7 1/2	3450	230/460	184T	18.05	3640M	184	88.5	40.5
M3709T	7 1/2	3450	230/460	213T	18.56	3640M	213	88.5	42.7
M3711T	10	3500	230/460	215T	17.91	3732M	215	89.5	57.3
M3713T	15	3450	230/460	215T	20.52	3750M	215	90.2	76.4
M2394T	15	3450	230/460	254T	21.09	0750M	254	90.2	107.7
M4106T	20	3450	230/460	256T	28.01	0750M	256	90.2	118.2
M4118T	25	3510	230/460	256T	23.16	0942M	256	91	127.7
M4107T	25	3510	230/460	284TS	26.39	0942M	284	91	164.1
M4108T	30	3510	230/460	286TS	26.39	0954M	286	91	173.6
M4109T	40	3540	230/460	324TS	28.78	1240M	324	91.7	220.9
M4114T	50	3540	230/460	326TS	28.90	1244M	326	92.4	261.4
M4310T	60	3550	230/460	364TS	30.72	1450M	364	93	334.5
M4313T	75	3550	230/460	365TS	30.72	1456M	365	93	352.3
M4402T-4	100	3550	460	405TS	35.06	1652M	405	93.6	473.2
M4412T-4	125	3560	460	444TS	40.49	1860M	444	94.5	574.5
M4413T-4	150	3560	460	445TS	40.50	1856M	445	94.5	722.7
M4416T-4	200	3560	460	445TS	40.50	1876M	445	95	840.9
M44252T-4	250	3560	460	449TS	48.90	1888M	449	95.2	825.9
M44302T-4	300	3560	460	449TS	48.90	18104M	449	95	645.9
M44352T-4	350	3560	460	449TS	48.90	18148M	449	95.4	1045.5
M44402T-4	400	3545	460	449TS	48.90	18160M	449	95.8	1276.4

C Face - 2 pole 3 phase 230/460V 60Hz 1.15 Service Factor TEFC

Catalogue No.	Hp	RPM at 60hz	Voltage	Nema Frame	Dim 'C' §	Baldor Type	Frame	FL Efficiency	Weight kg
KM3457	1/3	3450	230/460	56C	11.35	3410M	48	72	9.0
VM3537	1/2	3450	230/460	56C	11.35	3410M	48	68	8.6
VM3541	3/4	3450	230/460	56C	11.35	3413M	56	74	9.5
VM3545	1	3450	230/460	56C	11.35	3416M	56	75.5	10.5
VM3550T	1	3450	230/460	143TC	12.04	3424M	143	82.5	16.8
VM3555T	2	3450	230/460	143TC	12.92	3528M	145	84	19.5
VM3559T	3	3460	230/460	145TC	13.31	3528M	145	85.5	28.2
VM3613T	5	3450	230/460	184TC	16.55	3628M	184	87.5	33.2
VM3616T	7 1/2	3450	230/460	184TC	18.05	3640M	184	88.5	40.5
VM3711T	10	3500	230/460	215TC	18.64	3735M	215	89.5	57.3
VM3713T	15	3450	230/460	215TC	19.77	3744M	215	90.2	76.4
VM4106T	20	3450	230/460	256TC	20.33	0750M	256	90.2	118.2
VM4107T	25	3510	230/460	284TSC	26.39	1032M	284	91	164.1
VM4108T	30	3510	230/460	286TSC	26.39	1038M	286	91	173.6

§ Dimension 'C' is nominal length and all other nominal dimensions are specified against frame size in NEMA quick reference chart on page 27

Catalogue No's with shaded cells are stocked in Europe

NEMA frame, three phase AC motors

IN STOCK

B3/C Face - 2 pole 3 phase 230/460V 60Hz 1.15 Service Factor TEFC

Catalogue No.	Hp	RPM at 60hz	Voltage	Nema Frame	Dim 'C' §	Baldor Type	Frame	FL Efficiency	Weight Kg
CM3537	1/2	3450	230/460	56C	11.35	3410M	48	68	8.6
CM3541	3/4	3450	230/460	56C	11.35	3413M	56	74	9.5
CM3545	1	3450	230/460	56C	11.35	3416M	56	75.5	10.5
CM3550T	1	3450	230/460	143TC	13.31	3520M	143	82.5	16.8
CM3555T	2	3450	230/460	145TC	13.31	3526M	145	84	19.5
CM3559T	3	3460	230/460	145TC	14.19	3542M	145	85.5	28.2
CM3613T	5	3450	230/460	184TC	16.55	3630M	184	87.5	33.2
CM3616T	7 1/2	3450	230/460	184TC	18.05	3640M	184	88.5	40.5
CM3709T	7 1/2	3450	230/460	213TC	19.28	3640M	213	88.5	42.7
CM3711T	10	3500	230/460	215TC	18.64	3732M	215	89.5	57.3
CM3713T	15	3450	230/460	215TC	21.25	3750M	215	90.2	76.4
CM4106T	20	3450	230/460	256TC	23.66	0750M	256	90.2	118.2
CM4107T	25	3510	230/460	284TSC	26.39	1036M	284	91	164.1
CM4108T	30	3510	230/460	286TSC	26.39	1040M	286	91	173.6
CM4109T	40	3540	230/460	324TSC	28.78	1234M	324	91.7	220.9
CM4114T	50	3540	230/460	326TSC	28.78	1244M	326	92.4	261.4
CM4310T	60	3550	230/460	364TSC	30.72	1444M	364	93	334.5
CM4313T	75	3550	230/460	365TSC	30.72	1456M	365	93	352.3

B3 - 4 pole 3 phase 230/460V 60Hz 1.15 Service Factor TEFC

Catalogue No.	Hp	RPM at 60hz	Voltage	Nema Frame	Dim 'C' §	Baldor Type	Frame	FL Efficiency	Weight kg
M3353	1/8	1725	230/460	42	9.31	3313M	42	44	7.3
M3355	1/6	1725	230/460	42	9.31	3316M	42	62	7.7
M3454	1/4	1725	230/460	48	10.73	3410M	48	64	8.2
M3534	1/3	1725	230/460	56	11.35	3413M	56	68	9.5
M3538	1/2	1725	230/460	56	11.35	3416M	56	74	10.0
M3542	3/4	1725	230/460	56	11.35	3420M	56	75.5	11.8
M3546	1	1725	230/460	56	12.00	3426M	56	78.5	14.1
M3546T	1	1740	230/460	143T	12.31	3518M	143	82.5	16.4
M3554T	1 1/2	1740	230/460	145T	13.31	3524M	145	84	18.6
M3558T	2	1740	230/460	145T	13.31	3528M	145	84	20.5
M3611T	3	1750	230/460	182T	16.52	3546M	182	87.5	30.9
M3615T	5	1750	230/460	184T	16.55	3634M	184	87.5	35.9
M3710T	7 1/2	1760	230/460	213T	17.91	3735M	213	89.5	58.6
M3714T	10	1760	230/460	215T	19.03	3740M	215	89.5	63.2
M3774T	10	1760	230/460	215T	18.47	0740M	215	89.5	85.0
M2333T	15	1760	230/460	254T	23.19	0756M	254	91	110.9
M2334T	20	1760	230/460	256T	23.16	0938M	256	91	122.3
M4103T	25	1760	230/460	284T	27.76	0956M	284	92.4	180.0
M4104T	30	1760	230/460	286T	25.94	0964M	286	92.4	196.8
M4110T	40	1765	230/460	324T	30.28	1068M	324	93	235.0
M4115T	50	1760	230/460	326T	30.28	1080M	326	93	248.6
M4314T	60	1775	230/460	364T	32.84	1454M	364	93.6	339.5
M4316T	75	1775	230/460	365T	32.84	1476M	365	94.1	378.6
M4400T	100	1780	230/460	405T	38.06	1682M	405	94.5	508.2
M4410T-4	125	1780	460	444T	44.24	1868M	444	94.5	700.0
M4406T-4	150	1780	460	445T	44.24	1884M	445	95	645.9
M4407T-4	200	1780	460	445T	44.24	18112M	445	95	755.5
M4408T-4	250	1785	460	447T	47.74	18136M	447	95	853.2
M44304T-4	300	1785	460	449T	52.65	18152M	449	95.8	1170.0
M44354T-4	350	1785	460	449T	52.65	18168M	449	95.8	1218.2
M44404T-4	400	1785	460	449T	52.65	18180M	449	95.8	1274.5

§ Dimension 'C' is nominal length and all other nominal dimensions are specified against frame size in NEMA quick reference chart on page 27

Catalogue No's with shaded cells are stocked in Europe

NEMA frame, three phase AC motors

IN STOCK

C Face - 4 pole 3 phase 230/460V 60Hz 1.15 Service Factor TEFC

Catalogue No.	Hp	RPM at 60hz	Voltage	Nema Frame	Dim 'C' §	Baldor Type	Frame	FL Efficiency	Weight kg
KM3454	1/4	1725	230/460	56C	11.35	3410M	48	64	8.2
VM3534	1/3	1725	230/460	56C	11.35	3413M	56	68	9.5
VM3538	1/2	1725	230/460	56C	11.35	3416M	56	74	10.0
VM3542	3/4	1725	230/460	56C	11.35	3420M	56	75.5	11.8
VM3546	1	1725	230/460	56C	12.00	3426M	56	78.5	14.1
VM3546T	1	1740	230/460	143TC	12.06	3426M	143	82.5	16.4
VM3554T	1 1/2	1740	230/460	145TC	12.31	3520M	145	84	18.6
VM3558T	2	1740	230/460	145TC	13.31	3528M	145	84	20.5
VM3611T	3	1750	230/460	182TC	15.18	3535M	182	87.5	30.9
VM3615T	5	1750	230/460	184TC	16.55	3634M	184	87.5	35.9
VM3710T	7 1/2	1760	230/460	213TC	18.65	3729M	213	89.5	58.6
VM3714T	10	1760	230/460	215TC	19.77	0750M	215	89.5	85.0
VM2333T	15	1760	230/460	254TC	20.33	0744M	254	91	110.9
VM2334T	20	1760	230/460	256TC	23.66	0938M	256	91	122.3
VM4103T	25	1760	230/460	284TC	27.76	1034M	284	92.4	180.0
VM4104T	30	1760	230/460	286TC	27.76	1040M	286	92.4	196.8

B3/C Face - 4 pole 3 phase 230/460V 60Hz 1.15 Service Factor TEFC

Catalogue No.	Hp	RPM at 60hz	Voltage	Nema Frame	Dim 'C' §	Baldor Type	Frame	FL Efficiency	Weight kg
CM3534	1/3	1725	230/460	56C	11.35	3413M	56	68	9.5
CM3538	1/2	1725	230/460	56C	11.35	3416M	56	74	10.0
CM3542	3/4	1725	230/460	56C	11.35	3420M	56	75.5	11.8
CM3546	1	1725	230/460	56C	12.00	3426M	56	78.5	14.1
CM3546T	1	1740	230/460	143TC	13.31	3518M	143	82.5	16.4
CM3554T	1 1/2	1740	230/460	145TC	13.31	3524M	145	84	18.6
CM3558T	2	1740	230/460	145TC	13.31	3528M	145	84	20.5
CM3611T	3	1750	230/460	182TC	16.56	3546M	182	87.5	30.9
CM3615T	5	1750	230/460	184TC	16.55	3634M	184	87.5	35.9
CM3710T	7 1/2	1760	230/460	213TC	18.64	3735M	213	89.5	58.6
CM3774T	10	1760	230/460	215TC	19.24	0740M	215	89.5	85.0
CM2333T	15	1760	230/460	254TC	21.57	0756M	254	91	110.9
CM2334T	20	1760	230/460	256TC	23.66	0938M	256	91	122.3
CM4103T	25	1760	230/460	284TC	25.94	0956M	284	92.4	180.0
CM4104T	30	1760	230/460	286TC	25.94	0964M	286	92.4	196.8
CM4110T	40	1765	230/460	324TC	30.28	1248M	324	93	235.0
CM4115T	50	1760	230/460	326TC	30.28	1080M	326	93	248.6
CM4314T	60	1775	230/460	364TC	32.84	1254M	364	93.6	339.5
CM4316T	75	1775	230/460	365TC	32.84	1462M	365	94.1	378.6
CM4400T	100	1780	230/460	405TC	38.06	1682M	405	94.5	508.2

§ Dimension 'C' is nominal length and all other nominal dimensions are specified against frame size in NEMA quick reference chart on page 27

Catalogue No's with shaded cells are stocked in Europe

Large frame AC motors to 1120kW (1500 Hp)

- IEC or NEMA frames
- Ruggedised cast iron construction
- TEFC motors in stock to 375kW
- Standard stock ratings are 460V and 2300/4160V
- Choice of high efficiency or Baldor Super-E Premium Efficiency (EFF1) windings
- ISR® (Inverter Spike Resistant®) magnet wire, full Class H VPI insulation system for long life
- Rated for inverter drives
- Low loss stator and rotor design
- Service factor 1.15
- If it's not in stock, we can build it for you on short lead times

Large frame AC motors - Range overview

Enclosure	kW ratings	Hp ratings	Voltage Supply 60Hz	Voltage Supply 50Hz
Totally Enclosed Forced Cooled	185...670	250 - 900	460, 575, 950, 2300, 3300, 4160 or 6600	380, 400, 415, 950, 2300, 4160 or 6000
Open Drip Proof	150...1120	200 - 1500		
ODP Weather Proof 1	375...1120	500 - 1500		
ODP Weather Proof 11	375...1120	500 - 1500		
Inverter/Vector	185...600	250 - 800	460, 575 or 6600	380, 400, 415 or 6000
Explosion Proof	185...260	250 - 350	460 or 575	380, 400 or 415



Inverter and vector drive motors

- B3 foot and B5 flange mountings available
- IEC Frame sizes 80 to 250
- Ratings from 0.75 to 75 kW
- 1000:1 constant torque speed range
- 3 phase, 230-400V 50Hz
- Force ventilated
- Fitted with 1024 PPR encoder
- Fitted with thermostats as standard
- ISR® (Inverter Spike Resistant®) magnet wire, full Class H non-hygroscopic insulation system

Catalogue No.	Motor kW	Synchronous/Max. RPM	Rated A	Inertia kg cm2	IEC Frame	Mounting style	Weight kg	Baldor type no.
ZDNMM3581	0.75	1500/6000	1.7	72	D80-B5	D90-B3 Foot	29	0528M
ZDNMM3669	1.5	1500/6000	3.0	110	D90-B5	D112-B3 Foot	48	0628M
ZDNMM3661	2.2	1500/6000	4.7	169	D100-B5	D112-B3 Foot	53	0640M
ZDMM3665	3.7	1500/6000	7.1	156	112M	B3 Foot	62	0640M
ZDMM3665D	3.7	1500/6000	7.1	156	112D	B5 Flange	65	0640M
ZDMM3770	5.5	1500/6000	11.4	308	132M	B3 Foot	92	0738M
ZDMM3770D	5.5	1500/6000	11.4	308	132D	B5 Flange	96	0735M
ZDMM3774	7.5	1500/6000	14.4	440	132M	B3 Foot	98	0750M
ZDMM3774D	7.5	1500/6000	14.4	440	132D	B5 Flange	102	0750M
ZDMM2333	11.0	1500/5000	21.0	885	160M	B3 Foot	127	0948M
ZDMM2333D	11.0	1500/5000	21.0	969	160D	B5 Flange	133	0948M
ZDMM2334	15.0	1500/5000	27.0	969	160L	B3 Foot	141	0952M
ZDMM2334D	15.0	1500/5000	27.0	969	160D	B5 Flange	142	0952M
ZDMM4103	18.5	1500/4000	33.5	1879	180M	B3 Foot	187	1056M
ZDMM4104	22.5	1500/4000	41.0	1955	180L	B3 Foot	216	1058M
ZDMM4110	30.0	1500/4000	53.0	3285	200L	B3 Foot	250	1258M
ZDMM4115	37.0	1500/4000	67.0	4591	225S	B3 Foot	306	1458M
ZDMM4314	45.0	1500/4000	78.0	4888	225M	B3 Foot	362	1462M
ZDMM4316	56.0	1500/4000	101	8546	250S	B3 Foot	465	1660M
ZDMM4400	75.0	1500/3000	128	11399	250M	B3 Foot	537	1680M



ZDMM motors are fitted with an encoder for vector drive applications

Inverter duty gearmotors

- Parallel shaft and right angle gearbox options
- Rated at 0.28 kW at 230 VAC, 60Hz, 3-phase
- Operating frequency range 10 - 90 Hz
- Broad range of gear ratios
- ISR, inverter spike resistant magnet wire for increased protection against voltage spikes and corona damage
- Designed for use with inverters
- UL recognised, CSA certified and CE compliant



Inverter duty gearmotors - 0.28 kW, 230 VAC, 60 Hz, 3-phase

Catalogue No.	RPM @ 60 Hz	Ratio	Frequency range	Speed range	Torque @ 10 Hz Nm	Torque @ 20 Hz Nm	Torque @ 60 Hz Nm	Torque @ 90 Hz Nm	Type
Parallel shaft									
IDGMP2505	55	30	10-90	8-82	29	39	39	26	2528M-PSL
IDGMP2503	83	20	10-90	12-123	19	26	26	17	2528M-PSL
IDGMP2501	165	10	10-90	23-246	10	13	13	9	2528M-PSL
IDGMP2500	330	5	10-90	43-490	5	6	6	4	2528M-PSL
Right angle									
IDGM2509	22	75	10-90	3.4-33	25	35	35	28	2528M-K
IDGM2508	28	60	10-90	4.5-41	22	28	28	26	2528M-K
IDGM2506	41	40	10-90	6.6-62	17	26	26	22	2528M-K
IDGM2503	83	20	10-90	12-123	13	15	15	13	2528M-K
IDGM2501	165	10	10-90	23-246	7	9	12	9	2528M-K
IDGM2500	330	5	10-90	43-490	4	5	8	4	2528M-K

Certain models available from European stock - call for details

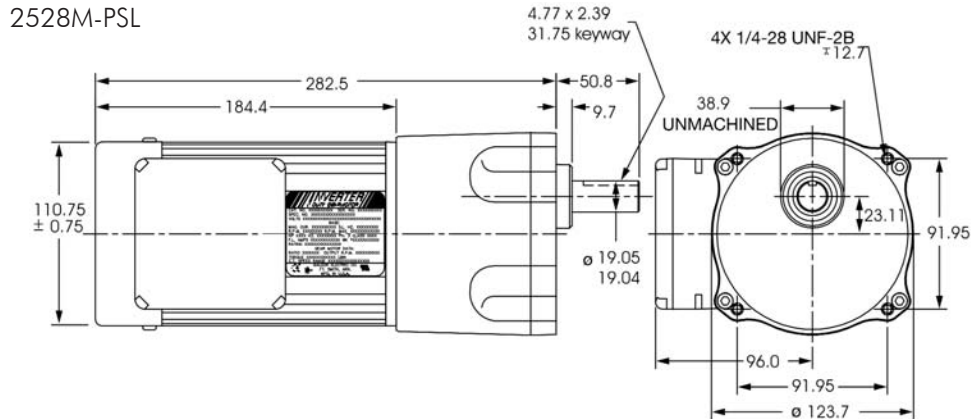

All dimensions in mm - for reference only

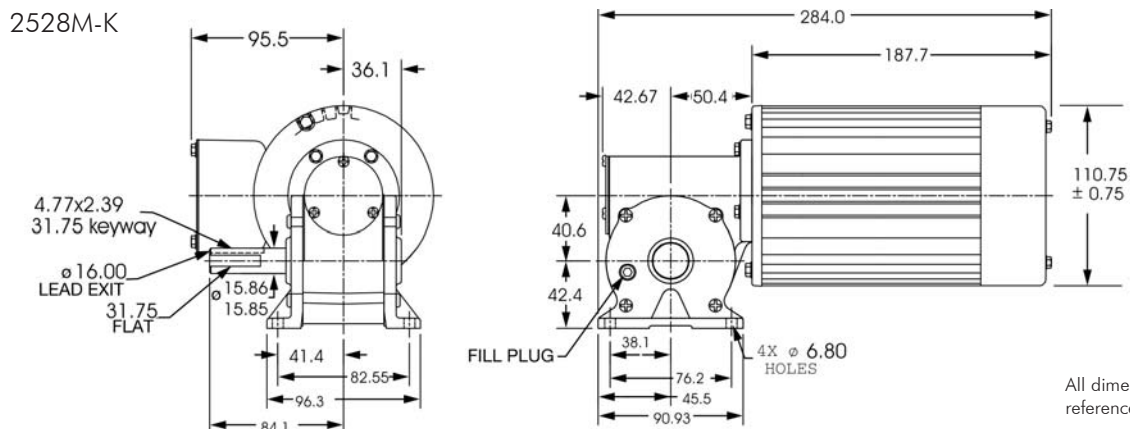

All dimensions in mm - for reference only

Baldor AC industrial drives overview

Baldor's VersaFlex range of AC drives complements our AC motor range. Available as frequency inverters, encoderless vector and vector drive configurations, in sizes up to 410kW, VersaFlex suits many applications. All drives are fitted with an easy to use keypad, that can also be remote mounted. The encoderless and vector drives have an optional Windows setup tool. Fieldbus communications are available on the VersaFlex vector drives for added flexibility.

VersaFlex inverter drive - series 35

- Output frequency 0-240Hz with 150% overload
- 0.25-7.5kW, 198-264/342-506VAC single/three phase
- Process follower 0-5VDC, 0-10VDC, 4-20mA, 0-20mA
- Selectable pre-set speeds and jog speed
- Analog meter and relay output
- DIN rail or panel mount

The VersaFlex inverter provides frequency control of AC motor speed in a form that is simple to apply. It comes with pre-programmed capability and a removable keypad for setup and control.

Choose the operating mode you want, and the drive can be ready for operation in minutes. Selectable features such as torque boost or V/Hz ratio, and skip frequencies increase versatility and extend the normal application range.



DC MOTORS

DC DRIVES

VersaFlex encoderless vector drive - series 37

- Encoderless vector control
- Power ratings up to 112kW
- Output frequency 0-240Hz with 150% peak overload
- Keypad or optional Windows set-up
- Optional built-in EMC filter for smaller units

The VersaFlex encoderless vector drive provides encoderless vector control for open loop induction motors. Closed loop current control, in

conjunction with a versatile control algorithm, regulates motor speed to precision levels. The drive can also be switched to traditional V/Hz control.

Control I/O configurations and application macros are easily created using the accompanying Windows based tool, Workbench-D. Pre-programmed applications such as PI control, or preset speeds can be set using the standard operator keypad.



AC MOTORS

AC DRIVES

VersaFlex closed loop vector drive - series 38

- Dynamic closed loop control
- May be used in encoderless or V/Hz mode
- Power ratings up to 410kW
- Encoder and I/O expansion options
- Fieldbus networking options
- Language selectable keypad

VersaFlex vector drive delivers the ultimate in AC motor adjustable speed control. A range of applications, from basic speed control, to tightly integrated multiple-drive systems can be easily achieved. Plug-in expansion modules provide the means to

connect VersaFlex vector drives into factory networks. Networks include DeviceNet, Modbus and Profibus.

The standard I/O is enough to support many sophisticated control and user interfaces. This I/O complement can be expanded with a factory installed module that adds additional encoder inputs, buffered encoder output, high speed digital I/O and high resolution analog inputs. VersaFlex is fully programmable using the accompanying Windows tool, Workbench-D.



MISC.

Baldor AC industrial drives overview

H - Series Inverter Drive

- NEMA 1 enclosure as standard
- Output frequency 0.25-120 Hz, optional 0.25- 400 Hz
- Peak overload to 200%
- Process follower 0-5 VDC, 0-10 VDC, 4-20 mA
- Free run or ramp stop
- Controlled reversing
- Selectable preset and jog speeds
- Dynamic braking and DC injection braking
- Analog meter outputs

Adjustable speed Inverter controls for AC Induction motors are available in a variety of ratings, input voltages, and enclosure styles. Whether you are automating equipment or preparing to save energy on fans and pumps Baldor has an easy to use motor control for all your needs.

From small mini inverters to floor mounted cabinets Baldor has stock ratings from 0.25 to 335kW. All units are UL and cUL listed and many are standard with ready to mount NEMA 1 enclosures and easy to use operator keypads.



SmartMotor™

- Totally Enclosed Fan Cooled (TEFC)
- Optional set-up and operate from Baldor's 32 character English-display keypad (order separately)
- NEMA standard motor frames
- Premium-efficiency motor designs
- NEMA Type 1 enclosure
- Dynamic braking built in

This breakthrough drive product combines adjustable speed control electronics with a Premium Efficiency industrial motor in one easy to install, easy to use package. The Baldor SmartMotor is available in 0.75 to 7.5kW covering NEMA frames from 56C to 215TC for standard and Washdown Duty designs.

Close Coupled Pump units in NEMA 143JM to 215JM frames are also available. UL / cUL Listing and C-Face with rigid mounting base is

standard and all models are available from stock. DC versions are also available.



DigiStart - Soft Starters

- For motor sizes 2.2 to 900kW
- 5 to 900A current rating
- Supply 230-460, 400-575 and 500-690V
- Automatic application set up Fan, Pump, Conveyor etc.
- Manual adjustment of Start and Stop times up to 255 seconds
- Start and Stop pedestals 10% to 60%
- Kick start for high break away torque applications

Baldor's soft starters eliminate downtime by removing mechanical stress. Available in two variants, the StartMaster, a low cost unit with 10 pre-programmed profiles and the MD series, with a keypad and English text display.

The MD series is available with a remote mountable keypad that can control up to 10 soft starters. A patented automatic energy optimiser with adjustable optimising response rate is available as standard.



IN STOCK
Call for details



Baldor AC industrial drives overview

H - Series Vector drives

- NEMA 1 enclosure as standard
- Digital speed control or torque control
- Full rated torque down to zero speed
- Auto tune capability
- Motor shaft orient to encoder marker or external switch closure
- Controlled reversing
- 15 preset speeds
- Dynamic braking
- Analog meter outputs

High performance Vector controls for AC Induction motors are available in a variety of ratings, and input voltages. Using Flux Vector control techniques and closed loop motor feedback the Baldor Vector control makes automating industrial equipment easy with the built in motor auto-tuning feature.

Baldor stocks ratings from 0.7 to 335 kW and has custom capabilities in larger horsepower sizes.

All units are UL and cUL listed and come standard with ready to mount NEMA 1 enclosures and easy to use Operator Keypads. Expansion capabilities for various I/O and Bus

Communications protocols are available with field installable expansion boards.



DC MOTORS

DC DRIVES

H - Series Vector line regen drives

- IGBT power devices for quiet operation
- Digital speed or torque control
- 16/32 Microprocessor controlled PWM output
- Output frequency 0-500 Hz
- Full rated torque down to zero speed
- Auto tune capability
- Motor shaft oriented to encoder marker or external switch closure
- 15 preset speeds

High performance Line Regen Vector controls for AC Induction motors are available in a variety of ratings, input voltages, and enclosure styles. Using Flux Vector control techniques and closed loop motor feedback the Baldor Line Regen Vector control adds even more capability in slowing a motor and saving energy at the same time.

No dynamic braking resistors are needed to bleed energy from the motor control. Near unity power factor and ability to meet IEEE-519 (1992) is easy with the built in sine wave input/output converter section.

Baldor has stock range ratings from 7.5 to 38kW and has custom capabilities in larger power sizes.

All units are UL and cUL listed and come standard with ready to mount NEMA 1 enclosures and easy to use operator keypads.



AC MOTORS

AC DRIVES

Washdown drives

- Inverter and Vector drives built to washdown standards
- All the features of our powerful Inverter and Vector drives with NEMA 4X enclosure as standard
- Available in standalone or built into SmartMotor™ integrated motor/drives

Baldor washdown duty adjustable motor controls are designed for applications where the equipment is subjected to brutal high-pressure washdown or exposed to elements of inclement weather. Inverter and Vector controls are available in NEMA 4X enclosures from 0.7 to 10kW.

All Washdown Duty controls are UL and cUL Listed. Inverter and Vector Duty motors are available in Paint Free and Epoxy Coated finishes from 1 to 10 Hp.

All Washdown Duty Inverter and Vector Drive Motors are UL recognised and meet NEMA MG1, Part 31.



IN STOCK
Call for details

MISC.

**COMPLETE STAINLESS STEEL
MOTORS AVAILABLE,
Call for details**

Other Baldor products

Baldor gearbox and speed reducer range

- Heavy duty cast iron housings with feet cast on top and bottom
- Forged bronze worm gears and Hardened steel worms
- Ball bearing on input shaft
- Tapered roller bearings on output shaft
- Integral heavy duty mounting
- Washdown and stainless steel version available

Baldor speed reducers are available with ratings up to 20kW. Our right angle speed reducers feature heavy-duty cast iron construction, chill cast bronze gears, precision ground worms and an internal expansion bladder that keeps the lubrication free of contaminants by eliminating the need to vent the gearbox. 900 Series speed reducers are dimensionally interchangeable with many other worm gear speed reducers and are factory filled with Mobil® SHC634 Synthetic oil.

Baldor also offers our 1000 Series in-line heavy-duty helical gear drives.

Models include double & triple reduction units in foot or flange mounted arrangements. Available in ratios from 1.5:1 to 250:1 and are factory filled with Mobil® SHC634 Synthetic oil. A wide range of Baldor speed reducers are available from stock from our European based warehouses.

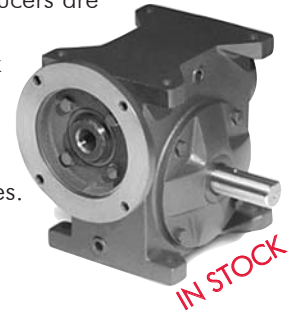

Baldor generators

Baldor manufacture a wide range of power generators for a wealth of power supply applications. The following is a brief overview, for more information visit www.baldor.com or contact your local Baldor representative.

generator sets to the state-of-the-art electronics and controls, these units are suited for all commercial, industrial and rental applications. Available from 25KVA/20kW to 175KVA/140kW.

8-25 kW ratings, these units continuously monitor the electrical current in your home or office and start up automatically if the utility power is interrupted.

Industrial Portables

Baldor portable generators are suitable for applications where portable power is needed. Available from 1300 to 11,000 watts these generators are designed for continuous operations. Portable generators are available in four models: full featured (Premier line); maximum value (Powerchief line); multi-fuel and diesel.



Open Industrial Standby

Industrial diesel engine-driven generator systems for industrial applications including agricultural confinement house operations, greenhouse facilities and dairy operations. Used also as power systems for Municipality services such as water treatment plants and emergency centres. Available in sizes 30kW to 150kW.

Industrial Standby / Prime Power

Baldor IDLC generators are at work all over the globe. For peak shaving duty, IDLC generators can supply prime power in parallel with the utility. In the standby mode, the IDLC gensets can supply emergency power to all critical loads and selected loads as desired. Every IDLC power system is designed, engineered, built and tested to the customer's specific specifications. Baldor's IDLC diesel generator sets include ratings from 30kW to 2000kW.



Industrial Towable Standby

Baldor's switchable/towable diesel generators are engineered for superior reliability, versatility, durability and safety. From the ultra quiet sound attenuated enclosures and precision

Automatic Emergency Standby

The Automatic Emergency (AE) generators have been engineered and built to meet the emergency power needs of the residential and light commercial customer. Available from

DC MOTORS

DC DRIVES

AC MOTORS

AC DRIVES

MISC.

IEC - quick reference chart

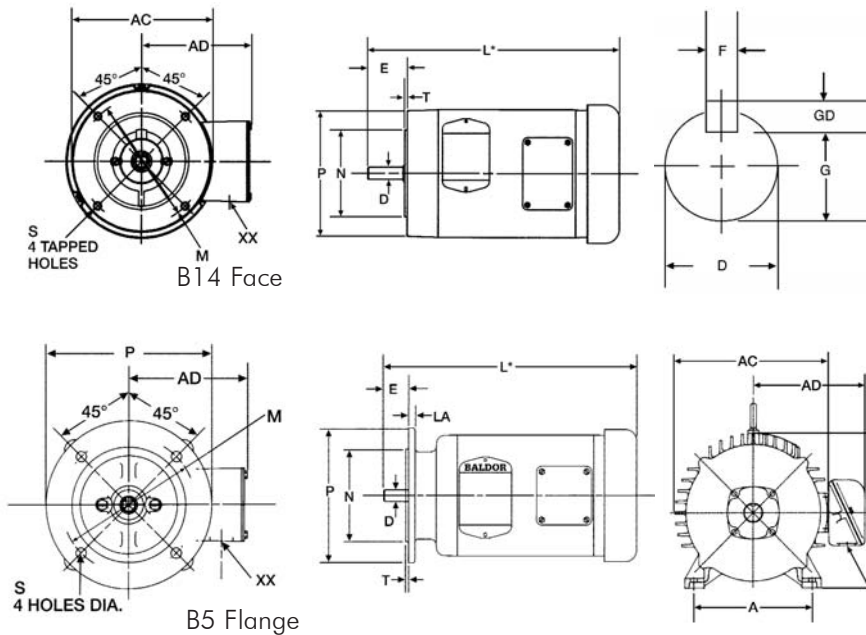

IEC Key and Keyseat dimensions									
FRAME	D	G	F	GD	FRAME	D	G	F	GD
63	11	8.5	4	4	160	37	42	12	8
71	14	11	5	5	180	48	42.5	14	9
80	19	15.5	6	6	200	55	49	16	10
90	24	20	8	7	225	60	53	18	11
100	28	24	8	7	250	70	67.5	20	12
112	28	24	8	7	280	80	71	22	14
132	38	33	10	8	315	85	76	22	14
					355	85	76	22	14

IEC Frame	Type	Foot mounting				Shaft		B5 flange				B14 face				General							
		A	B	C	H	D	E	LA	M	N	P	S	T	M	N	P	S	T	L	AC	AD	HC	XX
63	300	100	80	40	63	11	23	8	115	95	140	9	3	75	60	90	M5	2.5	*	119	102	121	13
71	300 400	112	90	45	71	14	30	8	130	110	160	10	3.5	85	70	105	M6	2.5	*	119 145d	102 102	136d 131	22d 18
80	400 500	125	100	50	80	19	40	13	165	130	200	11	3.5	100	80	120	M6	3	*	145 168d	115 130d	152 162d	22 21d
90	S L	140	100 125	56	90	24	50	13	165	130	200	12	3.5	115	95	140	M8	3	*	144d	107d	165d	21d
100	S L	160	112 140	63	100	28	60	14	215	180	250	14	4	130	110	160	M8	3.5	*	200	149	180	27
112	S M	190	114 140	70	112	28	60	14	215	180	250	14	4	130	110	160	M8	3.5	*	200	149	214	27
132	S M	216	140 178	89	132	38	80	14	265	230	300	14	4	165	130	200	M8	3.5	*	243	187	256	27
160	M L	254	210 254	108	160	42	110	20	300	250	350	19	5	215	180	250	M12	4	*	329	242	329	35
180	M L	279	241 279	121	180	48	110	20	300	250	350	19	5					*		395	333	372	51
200	L M	318	267 305	133	200	55	110	27	350	300	400	19	5					*		441	359	416	63
225	S M	356	286 311	149	225	60	140	19	400	350	450	19	6					*		495	383	483	63
250	S M	406	311 349	168	250	70	140											*		520	457	513	63
280	S M	457	368 419	190	280	80	170											*		616	497	581	63
315	S M	508	406 457	216	315	85	170											*		759	683	682	102
355	S L	610	500 630	254	355	85	170											*		759	683	719	102

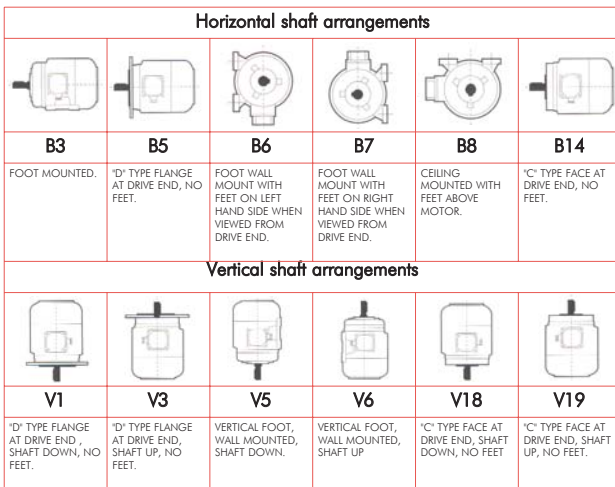

IP Protection Baldor Enclosures	
IP22	Open Drip Proof AC or DC Motors
IP54	All standard TEFC AC and DC Motors
IP55	All TEFC Chemical Processing, Dirty Duty, and Washdown Duty Motors

Summary of IP protection numbers		
First number Protection against solid objects	Second number Protection against liquids	
0 NO PROTECTION	0 NO PROTECTION	
1 Protection against solid objects up to 50 mm. (E.G. Accidental touch by hands.)	1 Protection against vertical drops of water. (E.G. Condensation.)	
2 Protection against solid objects up to 12 mm. (E.G. Fingers)	2 Protection against falling water up to 15 degrees from the vertical.	
3 Protection against solid objects over 2.5 mm. (E.G. Tools, Wires))	3 Protection against falling water up to 60 degrees from the vertical.	
4 Protection against solid objects over 1 mm. (E.G. Tools, Wires, and Small Wires)	4 Protection against splashing water from all directions, limited ingress.	
5 Protection against dust - limited ingress (No harmful deposits)	5 Protection against low pressure jets of water from all directions, limited ingress.	
6 Totally protected against all dust.	6 Protection against strong jets of water. (E.G. Use on shipdecks, limited ingress.)	
	7 Protection against immersion.	
	8 Protection against submersion.	

Drawings represent standard TEFC general purpose motors
*Dimensions are for reference only. All dimensions in mm

'L' dimension - see IEC motor sections in this catalogue for these dimensions or contact your local Baldor sales office

NEMA - quick reference chart

DC MOTORS

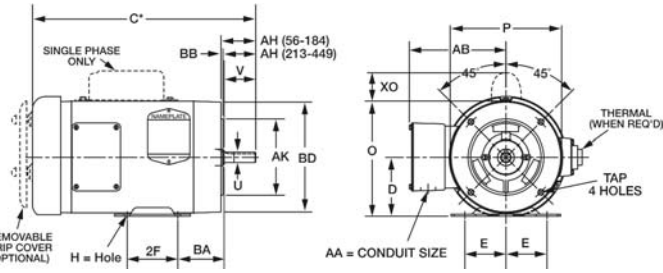

NEMA Keyseat details					
Shaft diameter	Keyseat dimensions		Shaft diameter	Keyseat dimensions	
	U	R		U	R
3/8	21/64	FLAT	1-7/8	1-19/32	1/2
1/2	29/64	FLAT	2-1/8	1-27/32	1/2
5/8	33/64	3/16	2-3/8	2-1/64	5/8
7/8	49/64	3/16	2-1/2	2-3/16	5/8
1-1/8	63/64	1/4	2-7/8	2-29/64	3/4
1-3/8	1-13/64	5/16	3-3/8	2-7/8	7/8
1-5/8	1-13/32	3/8	3-7/8	3-5/16	1

DC DRIVES

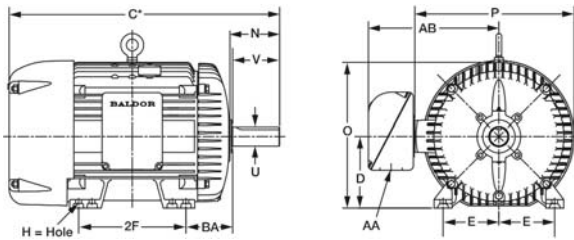

NEMA C-Face, BA dimensions	
NEMA Frame	BA
143-5TC	2-3/4
182-4TC	3-1/2
213-5TC	4-1/4
254-6TC	4-3/4

AC MOTORS

NEMA frame	D	E	2F	H	N	O	P	U	V	AA	AB	AH	AJ	AK	BA	BB	BD	XO	TAP
42	2-5/8	1-3/4	1-11/16	9/32 SLOT	1-1/2	5	4-11/16	3/8	1-1/8	3/8	4-1/32	1-5/16	3-3/4	3	2-1/16	1/8	4-5/8	1-9/16	1/4-20
48	3	2-1/8	2-3/4	11/32 SLOT	1-7/8	5-7/8	5-11/16	1/2	1-1/2	1/2	4-3/8	1-11/16	3-3/4	3	2-1/2	1/8	5-5/8	2-1/4	1/4-20
56 56H	3-1/2	2-7/16	3 5	11/32 SLOT 2-1/8	2-7/16 2-1/8	6-7/8	6-5/8	5/8	1-7/8	1/2	5	2-1/16	5-7/8	4-1/2	2-3/4	1/8	6-1/2	2-1/4	3/8-16
143T 145T	3-1/2	2-3/4	4 5	11/32	2-1/2	6-7/8	6-5/8	7/8	2-1/4	3/4	5-1/4	2-1/8	5-7/8	4-1/2	2-1/4	1/8	6-1/2	2-1/4	3/8-16
182 184 182T 184T	4-1/2	3-3/4	4-1/2 5-1/2 4-1/2 5-1/2	13/32	2-11/16 2-11/16 3-9/16 3-9/16	8-11/16	7-7/8	7/8	2-1/4 2-1/4 2-3/4 2-3/4	3/4	5-7/8	2-1/8 2-1/8 2-5/8 2-5/8	5-7/8 5-7/8 7-1/4 7-1/4	4-1/2 4-1/2 8-1/2 8-1/2	2-3/4	1/8 1/4 1/4	6-1/2 6-1/2 9 9	2-3/8	3/8-16 3/8-16 1/2-13 1/2-13
215 213 213T 215T	5-1/4	4-1/4	5-1/2 7 5-1/2 7	13/32	3-1/2 3-1/2 3-7/8 3-7/8	10-1/4	9-9/16	1-1/8 1-1/8 1-3/8 1-3/8	3 3 3-3/8 3-3/8	3/4	7-3/8	2-3/4 2-3/4 3-1/8 3-1/8	7-1/4	8-1/2	3-1/2	1/4	9	2-3/4	1/2-13
254U 256U 254T 256T	6-1/4	5	8-1/4 10 8-1/4 10	17/32	4-1/16 4-1/16 4-5/16 4-5/16	12-7/8	12-15/16	1-3/8 1-3/8 1-5/8 1-5/8	3-3/4 3-3/4 4 4	1	9-5/8	3-1/2 3-1/2 3-3/4 3-3/4	7-1/4	8-1/2	4-1/4	1/4	10	---	1/2-13
284U 286U 284T 286T 284TS 286TS	7	5-1/2	9-1/2 11 9-1/2 11 9-1/2 11	17/32	5-1/8	14-5/8	14-5/8	1-5/8 1-5/8 1-7/8 1-7/8 1-5/8 1-5/8	4-7/8 4-7/8 4-5/8 4-5/8 3-1/4 3	1-1/2	13-1/8	4-5/8 4-7/8 4-3/8 4-3/8	9	10-1/2	4-3/4	1/4	11-1/4	---	1/2-13
324U 326U 324T 326T 324TS 326TS	8	6-1/4	10-1/2 12 10-1/2 12 10-1/2 12	21/32	5-7/8 5-7/8 5-1/2 5-1/2 3-15/16 3-15/16	16-1/2	16-1/2	1-7/8 1-7/8 2-1/8 2-1/8 1-7/8 1-7/8	5-5/8 5-5/8 5-1/4 5-1/4 3-3/4 3-3/4	2	14-1/8	5-3/8 5-3/8 5 5	11	12-1/2	5-1/4	1/4	13-3/8	---	5/8-11
364U 365U 364T 365T 364TS 365TS	9	7	11-1/4 12-1/4 11-1/4 12-1/4 11-1/4 12-1/4	21/32	6-3/4 6-3/4 6-1/4 6-1/4 4 4	18-1/2	18-1/4	2-1/8 2-1/8 2-3/8 2-3/8 1-7/8 1-7/8	6-3/8 6-3/8 5-7/8 5-7/8 3-3/4 3-3/4	2-1/2	15-1/16	6-1/8 6-1/8 5-5/8 5-5/8	11	12-1/2	5-7/8	1/4	13-3/8	---	5/8-11
404U 405U 404T 405T 404TS 405TS	10	8	12-1/4 13-3/4 12-1/4 13-3/4 12-1/4 13-3/4	13/16	7-3/16 7-3/16 7-5/16 7-5/16 4-1/2 4-1/2	20-5/16	20-1/8	2-3/8 2-3/8 2-7/8 2-7/8 2-1/8 2-1/8	6-7/8 6-7/8 7 7 4 4	3	18	7	11	12-1/2	6-5/8	1/4	13-7/8	---	5/8-11
444U 445U 444T 445T 447T 449T 444TS 445TS 447TS 449TS	11	9	14-1/2 16-1/2 14-1/2 16-1/2 20 25 14-1/2 16-1/2 20 25	13/16	8-5/8 8-5/8 8-1/2 8-1/2 8-15/16 8-15/16 5-3/16 5-3/16 4-15/16 4-15/16	22-7/8 22-7/8 22-7/8 22-7/8 22-15/16 22-15/16 22-7/8 22-7/8 22-15/16 22-15/16	22-3/8 22-3/8 22-3/8 22-3/8 23-3/4 23-3/4 2-3/8 2-3/8 2-3/8 2-3/8	8-5/8 8-5/8 8-1/2 8-1/2 8-1/2 8-1/2 4-3/4 4-3/4 4-3/4 4-3/4	3	19-9/16 19-9/16 19-9/16 19-9/16 21-11/16 21-11/16 19-9/16 19-9/16 21-11/16 21-11/16	8-3/8 8-3/8 8-1/4 8-1/4 8-1/4 8-1/4 4-1/2 4-1/2 4-1/2 4-1/2	14	16	7-1/2	1/4	16-3/4	---	5/8-11	

AC DRIVES

MISC.

Drawings represent standard TEFC general purpose motors

*Dimensions are for reference only.

'C' dimension - See relevant NEMA sections of this catalogue

for these dimensions or contact your local Baldor sales office

Dimensions N, O, P, AB AND XO are specific to Baldor.

All dimensions are in inches.

Conversion tables and useful information

To convert from A to B, multiply by value in table

Rotary inertia

A \ B	gm-cm ²	oz-in ²	gm-cm-s ²	kg-cm ²	lb-in ²	oz-in-s ²	lb-ft ²	Kg-cm-s ²	lb-in-s ²
gm-cm ²	1	5.46x10 ⁻³	1.01x10 ⁻³	10 ⁻³	3.417x10 ⁻⁴	1.41x10 ⁻⁵	2.37x10 ⁻⁶	1.01x10 ⁻⁶	8.85x10 ⁻⁷
oz-in ²	182.9	1	0.186	0.182	0.0625	2.59x10 ⁻³	4.34x10 ⁻⁴	1.86x10 ⁻⁴	1.61x10 ⁻⁴
g-cm-s ²	980.6	5.36	1	0.9806	0.335	1.38x10 ⁻²	2.32x10 ⁻³	10 ⁻³	8.67x10 ⁻⁴
kg-cm ²	1000	5.46	1.019	1	0.3417	1.41x10 ⁻²	2.37x10 ⁻³	1.019x10 ⁻³	8.85x10 ⁻⁴
lb-in ²	2.92x10 ³	16	2.984	2.926	1	4.14x10 ⁻²	6.94x10 ⁻³	2.98x10 ⁻³	2.59x10 ⁻³
oz-in-s ²	7.06x10 ⁴	386.08	72	70.615	24.13	1	0.1675	7.20x10 ⁻²	6.25x10 ⁻²
lb-ft ²	4.21x10 ⁵	2304	429.71	421.40	144	5.967	1	0.4297	0.3729
kg-cm-s ²	9.8x10 ⁵	5.36x10 ³	1000	980.66	335.1	13.887	2.327	1	0.8679
lb-in-s ²	1.129x10 ⁶	6.177x10 ³	1.152x10 ³	1.129x10 ³	386.08	16	2.681	1.152	1

Torque

A \ B	oz-in	kg-cm	lb-in	Nm	lb-ft	kg-m
oz-in	1	7.200x10 ⁻²	6.25x10 ⁻²	7.061x10 ⁻³	5.208x10 ⁻³	7.200x10 ⁻⁴
kg-cm	13.877	1	0.8679	9.806x10 ⁻²	7.233x10 ⁻²	10 ⁻²
lb-in	16	1.152	1	0.112	8.333x10 ⁻²	1.152x10 ⁻²
Nm	141.612	10.197	8.850	1	0.737	0.101
lb-ft	192	13.825	12	1.355	1	0.138
kg-m	1.388x10 ³	100	86.796	9.806	7.233	1

Power

A \ B	Watts	Kilowatts	ft.lb/sec	in-lb/sec	Hp
Watts (W)	1	1 x 10 ⁻³	0.74	8.85	1.34 x 10 ⁻³
Kilowatts (kW)	1000	1	738	8850	1.34
ft-lb/sec	1.35	1.36 x 10 ⁻³	1	12	1.82 x 10 ⁻³
in-lb/sec	0.113	1.13 x 10 ⁻⁴	8.3 x 10 ⁻²	1	1.52 x 10 ⁻⁴
Hp	746	0.746	550	6600	1

Length

A \ B	Inch (in)	Feet (ft)	Micron (µm)	Millimetre (mm)	Metre (m)
Inch (in)	1	8.33 x 10 ⁻²	2.54 x 10 ⁴	25.4	2.54 x 10 ⁻²
Feet (ft)	12	1	3.05 x 10 ⁵	305	0.305
Micron (µm)	3.937 x 10 ⁴	3.28 x 10 ⁴	1	0.001	1.0 x 10 ⁻⁶
Millimetre (mm)	3.937 x 10 ²	3.28 x 10 ²	1000	1	0.001
Metre (m)	39.37	3.28	1 x 10 ⁶	1000	1

Mass

A \ B	oz-m	lb-m	gm	kg
oz-m	1	6.25 x 10 ⁻²	28.35	2.835 x 10 ⁻²
lb-m	16	1	453.6	0.453
gm	3.53 x 10 ⁻²	2.205 x 10 ⁻³	1	0.001
kg	35.274	2.205	1000	1

Force

A \ B	oz-f	lb-f	Newtons	gm-f	Kg-f
oz-f	1	6.25 x 10 ⁻²	0.278	28.35	2.835 x 10 ⁻²
lb-f	16	1	4.448	453.6	0.4535
Newtons	3.596	0.225	1	101.9	0.1019
gm-f	3.53 x 10 ⁻²	2.205 x 10 ⁻³	9.81 x 10 ⁻³	1	0.001
kg-f	35.3	2.205	9.81	1000	1

Linear speed

A \ B	in/sec	ft/sec	mm/sec	m/sec	inch/min	ft/min	m/min	km/hour	miles/hour
in/sec	1	0.083	25.4	2.54 x 10 ⁻²	60	5	1.524	0.091	5.7 x 10 ⁻²
ft/sec	12	1	304.8	0.3048	720	60	18.29	1.09	0.682
mm/sec	3.937 x 10 ²	3.3 x 10 ³	1	0.001	2.36	0.197	0.059	3.6 x 10 ³	2.24 x 10 ³
m/sec	39.37	3.281	1000	1	2362.2	197	60	3.6	2.24
inch/min	0.0167	1.39 x 10 ⁻³	0.42	4.2 x 10 ⁻⁴	1	8.33 x 10 ⁻²	2.54 x 10 ⁻²	1.52 x 10 ⁻³	9.5 x 10 ⁻⁴
ft/min	0.2	0.0167	5.08	5.08 x 10 ⁻³	12	1	0.3048	1.8 x 10 ⁻²	1.14 x 10 ⁻²
m/min	0.656	5.46 x 10 ⁻²	16.667	1.67 x 10 ⁻²	39.4	3.28	1	5.9 x 10 ⁻²	0.37
km/hour	10.936	0.911	277.8	0.2778	656	54.67	16.67	1	0.62
miles/hour	17.59	1.47	447	0.447	1056	88	26.8	1.609	1

Conversion tables and useful information

DC MOTORS

Material Densities (ρ)

	oz/in ³	lb/in ³	gm/cm ³
Aluminum	1.57	0.098	2.72
Brass	4.96	0.31	8.6
Bronze	4.72	0.295	8.17
Copper	5.15	0.322	8.91
Plastic	0.64	0.04	1.11
Steel	4.48	0.28	7.75

Mechanism Efficiencies %

Acme Screw (Bronze Nut)	40-65
Acme Screw (Plastic Nut)	50-85
Ball Screw	90-95
Helical Gear	96-98
Spur Gear	90
Timing Belt/Pulley	90-97
Worm Gears	60-85

DC DRIVES

Friction Coefficients (sliding)

Steel on Steel	0.58
Steel on Steel (Greased)	0.15
Aluminum on Steel	0.45
Copper on Steel	0.36
Brass on Steel	0.40
Plastic on Steel	0.20
Linear Bearings	0.001

Temperature

°F =	(1.8x °C) + 32
°C =	.555 (°F - 32)

Gravity (Acceleration Constant)

g = 386 in/s ²	= 32.2 ft/s ²	= 9.8 m/s ²
---------------------------	--------------------------	------------------------

Calculating power requirements - P

Rotational

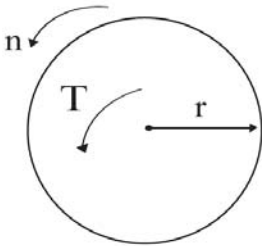

$$P \text{ (kW)} = \frac{T(\text{Nm}) \times n \text{ (rpm)}}{9549}$$

$$P \text{ (Hp)} = \frac{T(\text{lb ft}) \times n \text{ (rpm)}}{5252}$$

Lifting

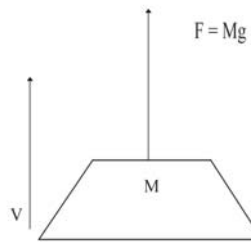

$$P \text{ (kW)} = \frac{M(\text{kg}) \times V \text{ (m/s)}}{102}$$

$$P \text{ (Hp)} = \frac{M(\text{lb}) \times V \text{ (ft/s)}}{550}$$

Linear

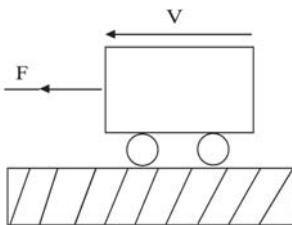

$$P \text{ (kW)} = \frac{F(\text{N}) \times V \text{ (m/s)}}{1000}$$

$$P \text{ (Hp)} = \frac{F(\text{lb}) \times V \text{ (ft/s)}}{550}$$

Calculating torque to accelerate in given time

$$T \text{ (Nm)} = \frac{J(\text{kgm}^2) \times \Delta N \text{ (rpm)}}{9.549 \times t \text{ (s)}}$$

Calculating Inertia

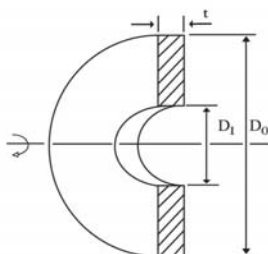

$$M = \frac{\pi \rho t}{4} \times (D_0^2 - D_1^2)$$

$$J = Mr^2 = \frac{\pi \rho t}{32} \times (D_0^4 - D_1^4)$$

$$J = Mr^2 = \frac{M}{8} \times (D_0^2 + D_1^2)$$

Units

D_0, D_1, t , in metres m

ρ in Kilograms / metre³ kgm³

M in Kilograms kg

J = Kilograms /metre² kgm²

AC MOTORS

AC DRIVES

MISC.

Notes

Notes

Visit www.baldor.com to request copies of these catalogues:

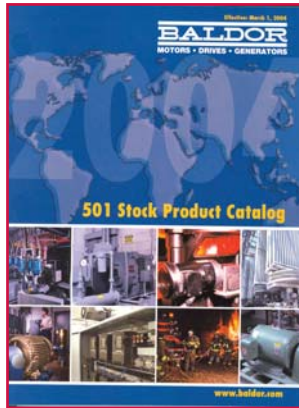

Stock Product Catalogue
BR 501

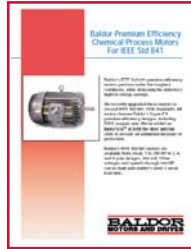

Chemical Process
Motors for IEEE 841
FL 420

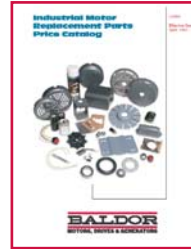

Industrial Motor
Replacement Parts
CA 506

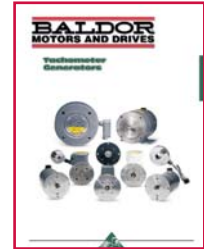

Tachogenerators
BR 602



Metric-E Motors
IBR 310



Total Power Solutions
BR 2405



Motion Control Products
Catalogue
BR 1202

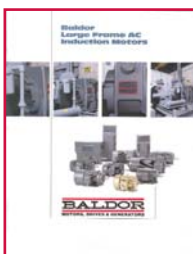

Large Frame AC Motors
BR 435

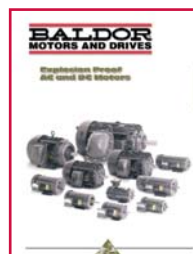

Explosion Proof Motors
BR 454

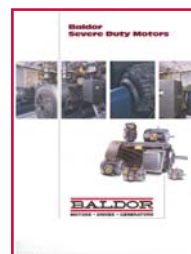

Severe Duty Motors
BR420



DC Motors
BR 600

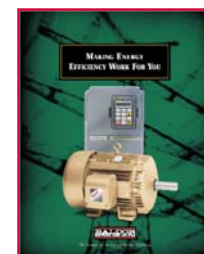

Energy Efficiency
BR 458

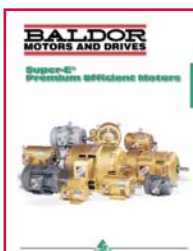

Super-E Motors
BR 457

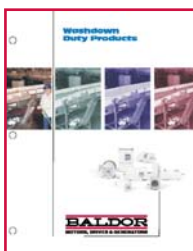

Washdown Duty
Products
BR 455



Versaflex AC & DC
Motor Controls
BR 735

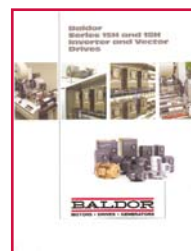

Series 15H & 18H
Inverter & Vector Drives
BR715



Inverter & Vector Drive
Motors
BR 400

AC and DC Industrial Motors and Drives

European Product Catalogue 501E

Baldor Value Formula

$$V_p = \frac{Q_p \times S_p}{C \times T}$$

Q = QUALITY S = SERVICE
C = COST T = TIME
P = PERCEIVED

The Baldor Value Formula is at the core of everything we do. From design to manufacturing, to sales and service, the Value Formula is the cornerstone from which we operate.

The formula illustrates the equal importance of four factors shaping our customers' perception of Value. We constantly make improvements in the Quality of our Products. We strive to improve the of Service to our customers, making their jobs easier. By improving Quality and Service while reducing the ownership Cost of our products and the Time it takes to deliver products to our customers, our Value (as perceived by the customer) continues to increase.... year after year.



Baldor's Mission Statement

To be the best (as determined by our customers) marketers, designers and manufacturers of industrial electric motors, drives and generators.



Baldor UK Ltd

Tel: +44 (0) 1454 850000
Fax: +44 (0) 1454 859002
email: sales.uk@baldor.com

Baldor ASR AG

Tel: +41 (0) 52 647 4700
Fax: +41 (0) 52 659 2394
email: sales.ch@baldor.com

Baldor ASR GmbH

Tel: +49 (0) 89 90508-0
Fax: +49 (0) 89 90508-491
email: sales.de@baldor.com

Baldor Italia S.R.L.

Tel: +41 91 640 99 50
Fax: +41 91 630 26 33
email: sales.it@baldor.com

Local Distributor: