

Data sheet

PCB Mounting Range

Range from 1.2-20va

1.2VA

Dimensions

Plan 30 x 32
 Height 24 above PC.B
 Pins 5 long x .8 dia.
 Weight 75g
 Regulation 12% typical

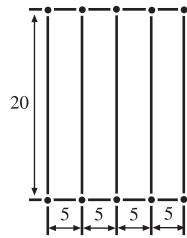

3VA

Dimensions

Plan 38 x 35
 Height 30 above PC.B
 Pins 5 long x .6 x .95
 Weight 130g
 Regulation 15% typical

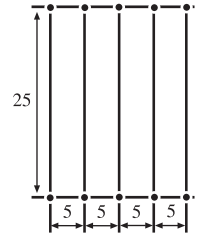

6VA

Dimensions

Plan 42 x 35
 Height 33 above PC.B
 Pins 5 long x .6 x .95
 Weight 170g
 Regulation 18% typical

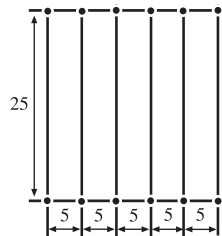

12VA

Dimensions

Plan 54 x 45
 Height 41 above PC.B
 Pins 5 long x .6 x .95
 Weight 350g
 Regulation 11% typical

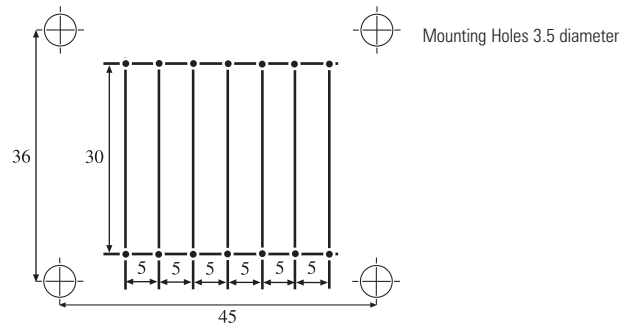

20VA

Dimensions

Plan 60 x 50
 Height 44 above PC.B
 Pins 5 long x .6 x .95
 Weight 480g
 Regulation 10% typical

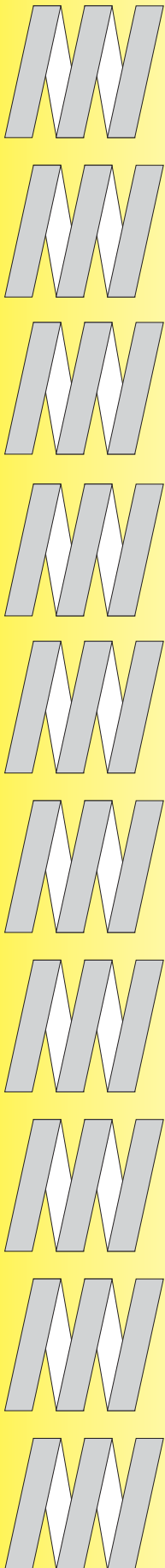
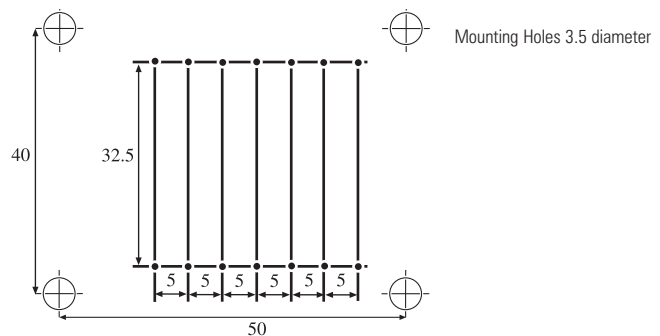

Data sheet

Clamp Constructions CP Range

Range from 5-100va

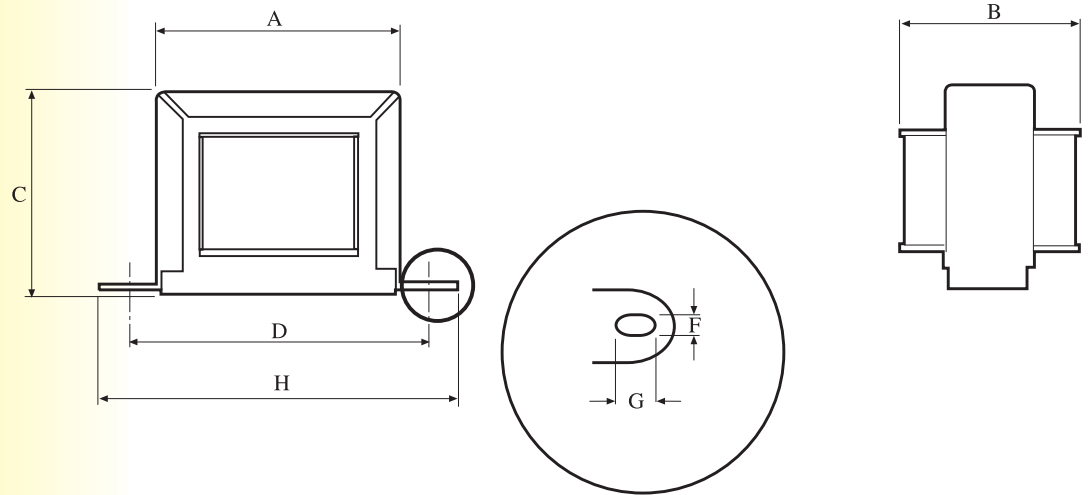

| Reference number | Outside dimensions (mm) | | | Fixing centres (mm) | | | Fixing slots (mm) | | Approx. weight kg |
|------------------|-------------------------|------|------|---------------------|-------|---|-------------------|------|-------------------|
| | A | B* | C | H | D | E | F | G | |
| CP18-9 | 45.0 | 32.5 | 37.5 | 66.7 | 54.0 | - | 3.97 | 6.35 | 0.20 |
| CP145-10 | 50.5 | 33.5 | 41.5 | 74.7 | 60.3 | - | 3.97 | 6.35 | 0.26 |
| CP74-11 | 55.0 | 36.0 | 46.0 | 81.0 | 68.3 | - | 4.76 | 8.73 | 0.34 |
| CP35-12 | 59.5 | 40.0 | 50.0 | 88.0 | 73.0 | - | 4.76 | 8.73 | 0.43 |
| CP35-16 | 59.5 | 46.5 | 50.0 | 88.0 | 73.0 | - | 4.76 | 8.73 | 0.54 |
| CP147-14 | 69.5 | 46.5 | 57.5 | 96.5 | 82.6 | - | 4.76 | 8.73 | 0.70 |
| CP147-16 | 69.5 | 50.0 | 57.5 | 96.5 | 82.6 | - | 4.76 | 8.73 | 0.75 |
| CP147-20 | 69.5 | 55.5 | 57.5 | 96.5 | 82.6 | - | 4.76 | 8.73 | 0.85 |
| CP29-16 | 79.0 | 60.5 | 66.5 | 105.0 | 92.1 | - | 4.76 | 9.52 | 0.95 |
| CP29-20 | 79.0 | 67.0 | 66.5 | 105.0 | 92.1 | - | 4.76 | 9.52 | 1.20 |
| CP196-18 | 88.0 | 67.0 | 73.0 | 118.0 | 102.0 | - | 4.76 | 9.52 | 1.40 |

* Note: Dimension B varies with construction
All dimensions in millimetres