

# **PRV** *Engineering Ltd*



Welcome to the fastest growing Engineering Company in Wales



**One Answer - Many Solutions**

Web. [www.prv-engineering.co.uk](http://www.prv-engineering.co.uk)  
Email. [sales@prv-engineering.co.uk](mailto:sales@prv-engineering.co.uk)



**Tel. +44 (0) 1495 769697**  
**Fax. +44 (0) 1495 769776**





PRV Engineering Ltd. was established in 1986, and since its inception, has expanded and developed its well-equipped 29000 sq. ft. facility in Pontypool, South Wales.

We manufacture for an expanse of industries from Food and Chemical Processing, Railway, Aircraft and Automotive to Pharmaceutical, Petrochemical, Defence and Construction to name but a few.

With disciplines such as General and CNC machining, Deep Hole Drilling, Welding and Fabrication, CAD/CAM links and Mechanical Installation Teams, we are able to provide a complex and diverse range of services and products to our customers and hopefully you as our new customer.

Quality is foremost on our agenda and all Products and Services offered by the company are completed in accordance with our Quality Standard **BS EN ISO 9001:2008** certification, which covers the following activities.

General and Precision Engineering producing Machined Components and Turned Parts, Wet Spray Painting and Powder Coating, Steelwork Fabrication, Installation and Maintenance

We manufacture from Own Design, Customer Drawings or OEM Samples depending on our customer's requirements, and if requested, provide complete drawings and stress analysis calculations.

Products in all materials from the very basic Mild Steels to the more exotics like, Monnel, Inconel Hastalloy and Titanium are produced. We cater for one off's, large batch production and Rapid Prototyping and supply a small stocking service to some of our customers enabling them to reduce their stock, and call off items as and when required.

At PRV Engineering we believe in providing you, the customer, with a comprehensive service to enable us to solve any problems you may have. Developing our working relationship so that you receive a higher quality service and product that will satisfy your requirements.

To this end we also offer a manufacturing development service to improve current products and production methods to attain a higher durability and more cost effective purchase. In short, if you want to make it better, we are here to help!!

The following pages outline some of our products, services and capacities. Please do not hesitate to contact us if you need further information, or would like to visit our facility, or have any current or future requirements.

Contact us on **Tel:** 01495 769697. **Fax:** 01495 769776.

Or visit our website at [www.prv-engineering.co.uk](http://www.prv-engineering.co.uk) or email us at [sales@prv-engineering.co.uk](mailto:sales@prv-engineering.co.uk)

Assuring you our best attention at all times,  
Yours Faithfully

Simon K Jones  
Managing Director





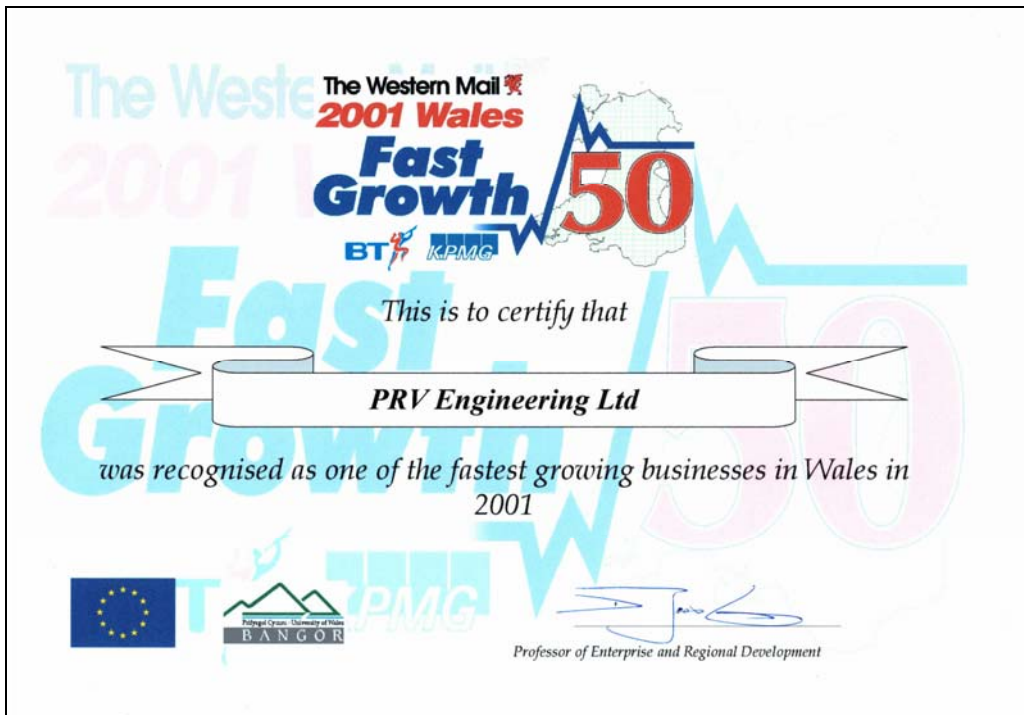

**Recognised as the 12<sup>th</sup> fastest growing Company in Wales in 2001  
And acknowledged as the 1<sup>st</sup> in the Manufacturing category**



## **MACHINING**

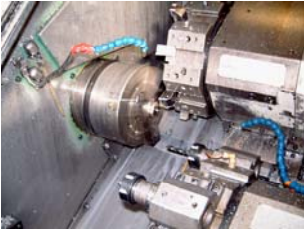

### *CNC Turning*

We have a large, well equipped CNC Department comprising 16 Machining Centres with a wide ranging capacity. Machining from the smallest of components up to 600mm Dia. over 2500mm in length and 1500 x 850 x 750 cube.



250 Dia. x 500 Long with simultaneous Dual Axis Machining.

350 Dia. x 500 Long with 70mm Dia. Bar Feed Capacity and Sub-Spindle Processing



350 Dia. x 500 Long with 70mm Dia. Magazine Bar Feed Capacity, 'Y' & 'C' Axis with Live Spindle Tooling



600 Dia. x 2600 long

All Turning centres have a CAD/CAM Link to enable the most complex of components to be programmed quickly and efficiently.

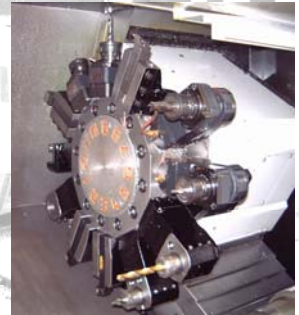

### *CNC Milling*

In our range of CNC machining centres we have up to (X) 1500mm (Y) 850mm (Z) 750mm with True 4<sup>th</sup> Axis capability (0.001 Deg. Resolution), Renishaw Probing, Helical Milling and Auto Pallet Change Facilities.



Horizontal Machining Centres with up to (X) 650mm (Y) 650mm (Z) 550mm and Auto Pallet Change Facility, Laser Tip Break Detection and Probing



As with Turning, all our Machining Centres also have CAD/CAM links with the addition of True 3D Modelling and an Engraving Facility for die sinking, pattern making and engraving of special purpose tooling and gauges.

Post Processing of extremely complex components from file Conversions such as IGS, STP, DXF, DGN, VDA & 3DM can be performed very quickly for rapid prototyping purposes.

## 5 AXIS MACHINING



PRV Engineering Ltd has developed through Acquisition and Constant Investment in new technology.

The latest addition to our Plant List is a Mazak VTC800/30SR seen above.

A Vertical Travelling Column Machining Center with full 5 Axis Synchronous Milling ability and a Large Machining Envelope enabling a wide variety of components to be manufactured.

(x) 3000mm x (y) 800mm x (z) 720mm and an 18000 rpm Spindle Speed.

5 Axis Machining is programmed with the aid of Edge Cam solid Modelling.

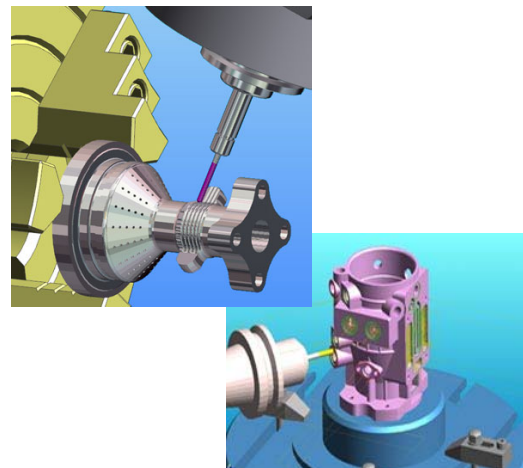
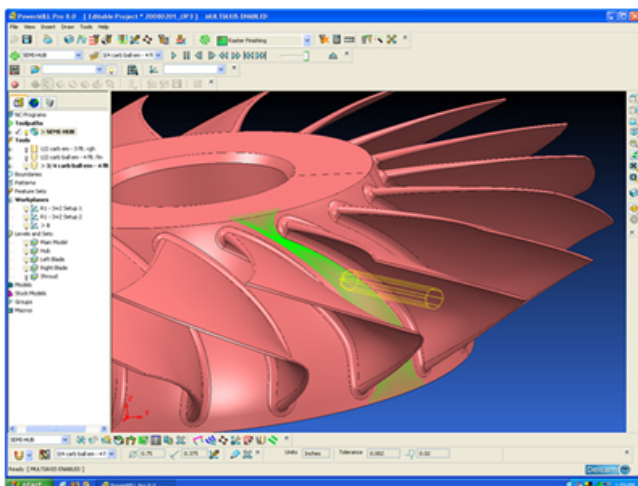



We manufacture from the Simplest of products, to more complicated items and assemblies for prototype Development and Testing.



**Conventional Turning**

520 Dia. x 2mtr Long  
 920 Dia. x 3mtr Long with 2mtr Taper Facility  
 1200 Dia. x 350 Long  
 200 Dia. x 3500 Long



**Milling**

(X) 1300 x (Y) 750 x (Z) 400 Universal  
 (X) 1500 x (Y) 850 x (Z) 700 Universal  
 (X) 1750 x (Y) 1000 x (Z) 750 Horizontal



**Grinding**

(Universal)  
 300 Dia. x 900 Long External 250 Dia. x 350 Long Internal

(Surface)  
 (X) 900mm x (Y) 400mm x (Z) 400mm



**Vertical Boring**

Webster & Bennett 3ft Borer  
 Webster & Bennett 4ft Borer with Mechanical Copy Facility



**Horizontal Boring**

2 x TOS Horizontal Borers (X) 2300 (Y) 2900 (Z) 2200  
 1 x Forges de Gilly (X) 1800 (Y) 2600 (Z) 1700

**Spark Erosion**

1 x AGIE Plunge Spark Erosion machine  
 (X) 400mm (Y) 300mm (Z) 300mm



To compliment the above we have also added part CNC/Manual Machines to our tool room facilities and all conventional equipment is fitted with Programmable Digital Readouts.

## **INSPECTION AND TESTING**

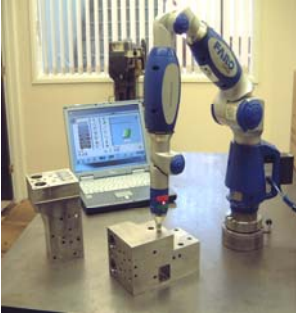

All Products manufactured are Inspected prior to delivery to Customers Drawings, Specifications and as per our ISO 9001:2000 Approval.

All Equipment used for both Processing and Inspection is Calibrated and Traceable by a NAMAS registered Body.



First Article Inspection Reports and Certificates of Conformity are available on request.

## **DEEP HOLE DRILLING**



Following the acquisition of a Deep Hole Drilling Company we have now added Ten Deep Hole Drilling Machines and various ancillary equipment and developed this service to encompass our complete range of processes.

We now offer services from Hole Drilling as a stand alone operation, or the complete manufacturing package, providing components processed to whatever stage our customers require.

Our capacities for this service are: ~

### **Non-cylindrical Components.**

\*Holes from 4mm up to 320mm Diameter in any position.  
Up to 2200mm Centres Dependent on Weight and Overhang.

### **Cylindrical Components.**

\*Holes from 4mm up to 320mm Diameter.  
Up to 6000mm in Length.

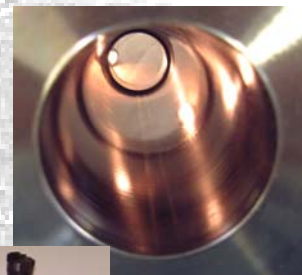

We have an extensive range of Gun Drills, Ejector Drills and Counter Boring Heads for the above capacities and offer Technical Assistance and On-site Drilling Services.

\*Dependent upon

- 1 Material Specification
- 2 Weight (Max 3 Tonnes)
- 3 Component Configuration

# **BUSBARS, CONDUCTORS, COPPER CONECTIONS, BRAIDS AND CONTACTS**

PRV Engineering specialise in the use of Copper to manufacture all manner of components for the Low, Medium and High Voltage Industries including Rail Rolling Stock and Trackside electrical components.

From Punching and Folding to Forging and Pressing, Complete Machined Castings and Stampings, Busbar Fabrication, Plating and Heat Shrink Sleeveing are all services provided for our Electrical Industry Customers.

Below are just a few of the many parts produced at our facility.



High Voltage Breaker Components

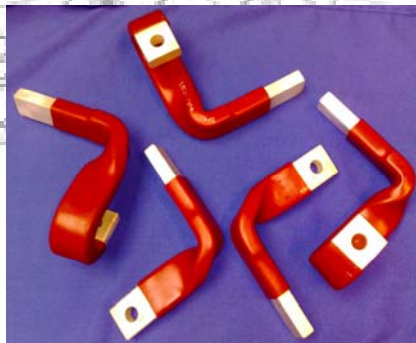

Swaged, Silver Plated and Heat Shrink Connection



Braids with Consolidated Ends



High Voltage Breaker Clusters



High Voltage Breaker Contacts



High Voltage Breaker Contacts



## **TOOLMAKING**



PRV Engineering was originally set up manufacturing Tamper Proof Lid Assemblies for the Metal Packaging Industry as its own product, and whilst we no longer perform this activity, we have retained the specialist knowledge to build and test Simple or Multi Tool Punch and Press Sets, from the very basic to the more complex progression tooling.

Our toolmakers now produce Punch, Press and Forming Tools, Die Sets and Tool Spares etc... on a sub-contract level for customer spares.

We have extended this service to the refurbishment of existing tooling, and offer our customers a service whereby we perform routine maintenance or emergency repair with a collection and delivery service enabling down times to be minimized.

## **FABRICATION**

We have developed an extensive fabrication department, capable of producing products and services from the very small to the larger products.

We specialise in the manufacture of Machinery Guarding, Conveyor Systems and Materials Handling Equipment, Access Platforms and Ladders, Architectural Balustrades and Balconies, in both Stainless and Mild Steel.

Machinery Guarding and Platforms,  
Balconies, Balustrades and Handrailing



We provide a High Quality Service to the Construction Industry, and have a comprehensive portfolio of Completed Projects, some of which are shown here. We enjoy excellent customer reviews for our Quality, Efficiency, Work Ethic and an Unblemished Health and Safety Record, and ensure at every level these key factors are constantly maintained and improved.

## **SPRAY PAINTING, POWDER COATING & SHOT BLASTING**



As part of our ongoing development, we were asked if we could provide a Quality Painted Finish by one of our customers, in consideration of this, we commissioned a Finishing Department made up of a 6 meter Shot Blast Room, Various Shot Blast Cabinets, Powder Coating Booth a Wet Paint Spray Room and a 2.2 meter cubic High Bake Oven.



In addition to the application techniques, we have also employed the means to test the finishes for depth and strength etc...

We now provide a high quality painted finish to very exacting standards for many of our customers.

## **DESIGN & DEVELOPMENT**

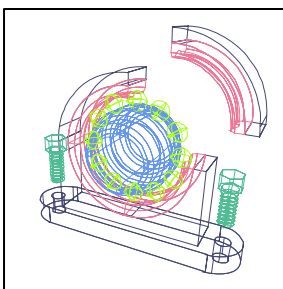

At PRV, we have the necessary skills and experience to Design and Develop products and services to meet your requirements, and with the use of Autocad, Autosketch, Bentley Microstation and Solid Edge, we can develop products in conjunction with our customers to achieve the most durable and cost effective solutions available.

We also provide Construction Industry Details, with the accompanying Stress Analysis Calculations.

To this end we contract for complete turnkey projects and delight in the opportunity to design, manufacture, install and maintain your requirements.

## **SITE WORK, INSTALLATION AND MAINTENANCE**

PRV Engineering offer an Installation and Maintenance Service of a very high standard indeed, installing both our own equipment and that of third parties, we have mechanically installed large plant for various companies providing transport, handling, lifting, welding and many other disciplines. We have developed an excellent reputation for both our work and safety ethic of which we are very proud, and will always endeavour to maintain and enhance this reputation.



As an Engineering and Fabrication company with a wide scope of services we are

able to offer a higher level of efficiency than our competitors, where some companies fail when a problem is found, waiting for customer intervention to assist or correct the problem, we are

invariably able to continue, solving and engineering the solution as we go relieving you of just another problem to worry about. This has proven to be an invaluable asset, and we have enjoyed excellent reviews regarding our efficiency.

Site Instructions, Method Statements, Risk Assessments and other relevant qualifications are provided for all work undertaken in accordance with the CDM regulations of 1994, and this is foremost in our approach to the safe and efficient provision of our services.

We currently provide Mechanical Installation, Site Fabrication and Maintenance Services to companies such as Du Pont and Astra Zeneca Pharmaceuticals on an ongoing basis

Thank you for the time taken in reading this brochure, I do hope it is of interest to you and your company, and that you will consider PRV Engineering Ltd for any current or future requirements you may have.

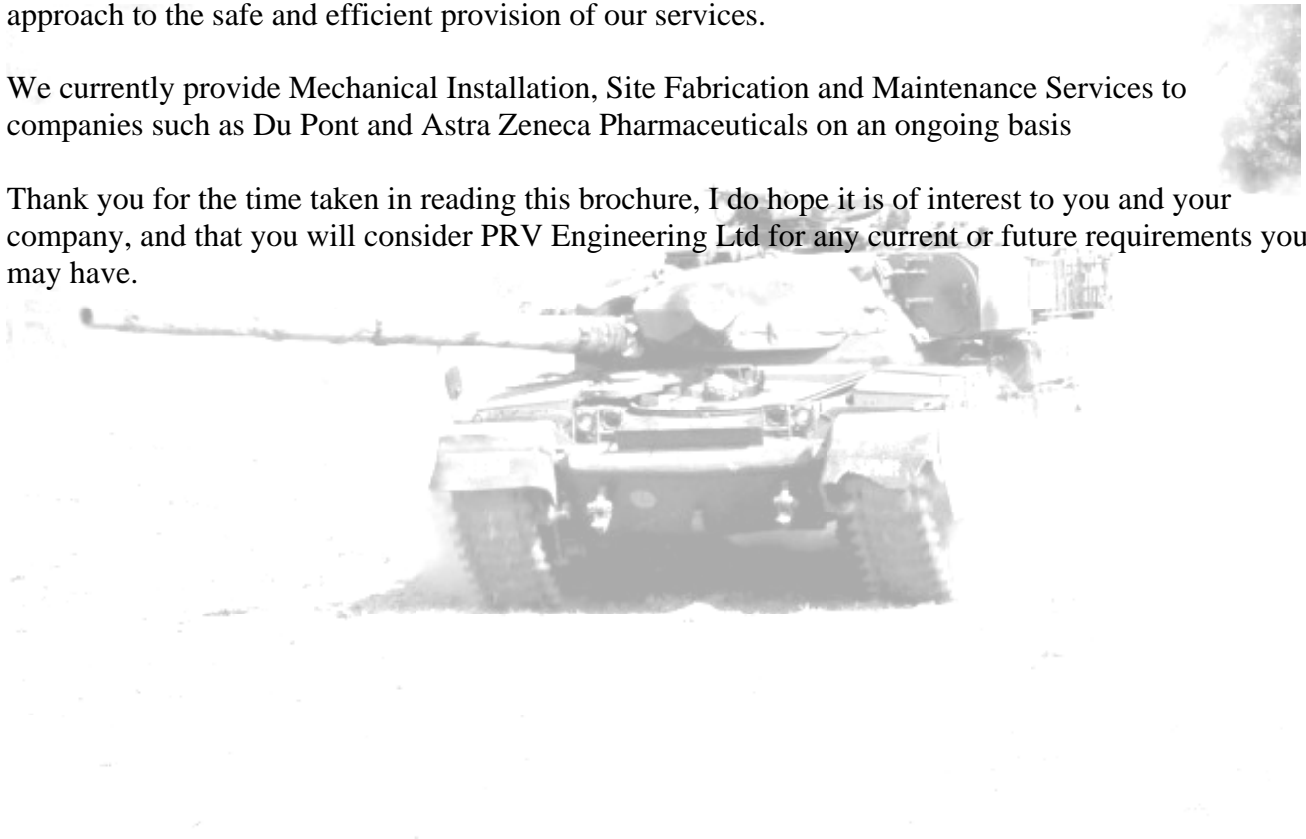



**SOME OF THE PRODUCTS AND SERVICES WE OFFER.**

**SERVICES**

**General and Precision Engineering.**  
**CNC Machining with True 4th Axis Capability.**  
**CNC Machining with Live Tooling.**  
**Full 5 Axis Synchronous CNC Machining.**  
**Deep Hole Drilling.**  
**CAD/CAM Post Processing.**  
**High & Low Volume Turned Parts.**  
**Sheet Metal Work & Fabrication.**  
**Shot Blasting.**  
**Prototype Development and Testing.**  
**Complete Turnkey Requirements.**  
**Press Tool Manufacture and Refurbishment.**  
**Mechanical Installation.**  
**Maintenance.**

**PRODUCTS**

**Material Handling Equipment.**  
**Conveyor Systems.**  
**OEM Spares.**  
**Custom Signs.**  
**Special Purpose Tooling.**  
**Gauges.**  
**Busbars.**  
**Electrical Conductors and Contacts.**  
**Machinery Guarding.**  
**Architectural Railings.**  
**Balustrades and Balconies.**  
**Complete Machined Castings.**  
**Rail and Track Products.**  
**Manufacturers of Valves and Valve Parts.**  
**Access Platforms and Ladders.**

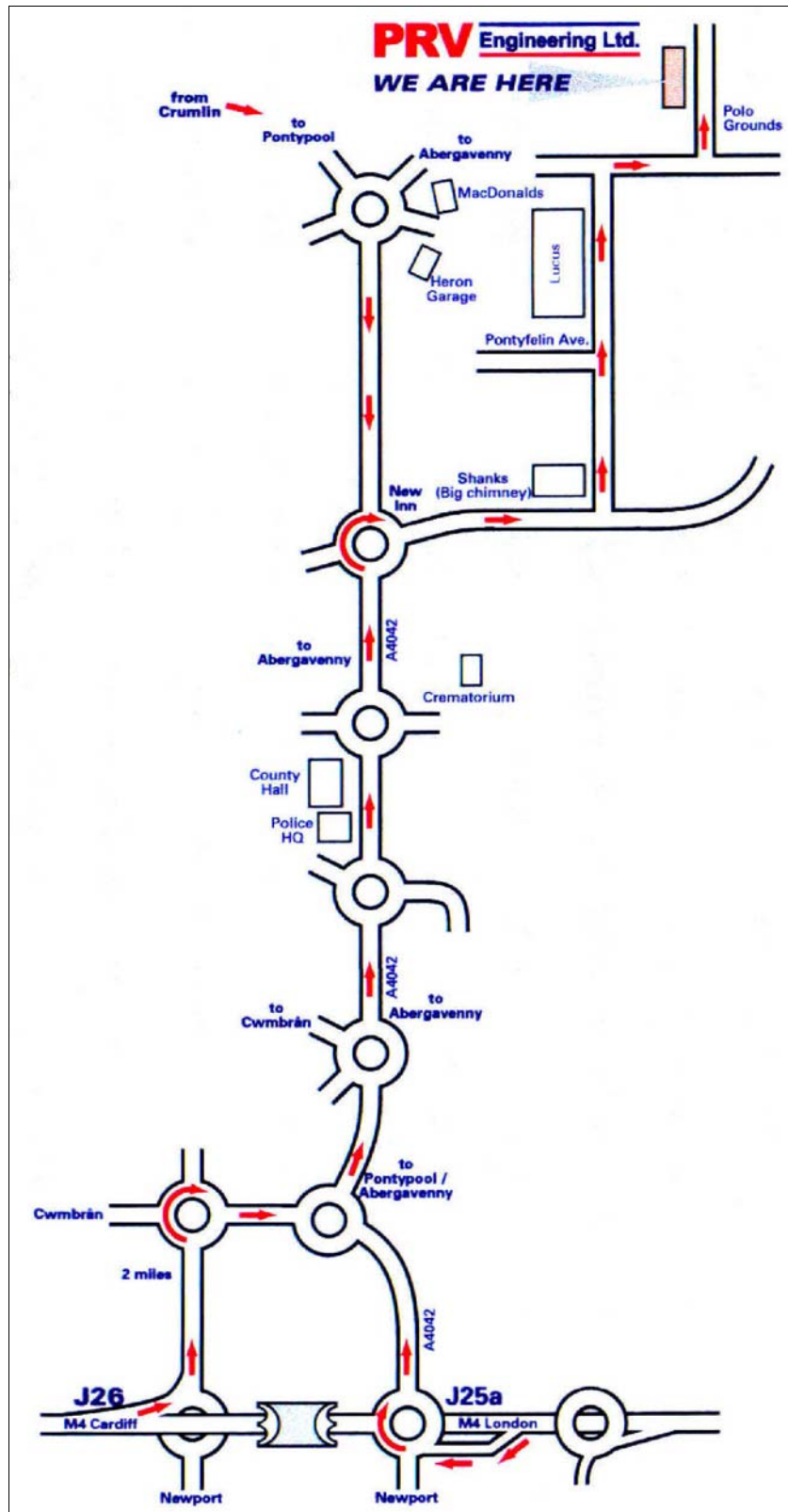

PRV Engineering Ltd  
 Pegasus House  
 Polo Grounds  
 New Inn  
 Pontypool  
 South Wales NP4 0TW

Tel: 01495 769697  
 Fax: 01495 769776  
 Email: [sales@prv-engineering.co.uk](mailto:sales@prv-engineering.co.uk)  
 Web: [www.prv-engineering.co.uk](http://www.prv-engineering.co.uk)  
 Co. Reg: 2075421  
 Vat: GB 927 1732 20