



Caterbox[®]

Pack. Protect. Store.



Contents

Correx Glass & Cup Boxes	4-5
Solid Glass & Cup Boxes	6-7
Ventilated Glass & Cup Crates	8-9
Conveyor Glass & Cup Crates	10-11
Conveyor Racks	12-13
Dishwasher Racks	14-17
Dishwasher Baskets & Accessories	18
Glasswasher Racks & Baskets	19
Solid Glasswear Boxes	20
Cutlery Storage	21
Plate Boxes	22-23
Solid Euro Containers & Cases	24-25
Stackable Storage Containers	26-27
Box Dividers	28
Bespoke Storage Boxes	29
Transport Trolleys & Palletisation	30



Pack. Protect. Store.



Fries UK distributor



Product knowledge



Top quality products



Everything under one roof

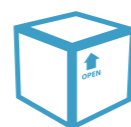

Quick turnaround

Thermo Transfer Print & Vinyl Labels



Thermo Transfer Print

Thermal transfer print is a high-quality well-presented branding option that will leave a lasting impression on your clients and their guests. A permanent and durable print is made directly on to the box using thermal technology, suitable for dishwashing & conveyor washing. Our thermal transfer print can be applied to all types of boxes and crates, used widely by caterers, event hire & glass loan companies. Look professional and prevent your boxes from being misplaced, getting mixed up or going walkabout. In addition to identifying your belongings, your branded boxes will continue to promote your business.

Print suitable for:

- Solid Euro Containers
- Solid Euro Cases
- Euro Container Lids
- Ventilated Euro Crates
- Conveyor Racks
- Dishwasher Racks
- Attached Lid Containers
- Crockery Transport Boxes

Thermo Transfer Print Options

- Logo printing
- Text/Number printing
- Bar Code printing
- QR Code printing
- Black or White printing
- Colour printing



Vinyl Labels

Personalising your storage boxes and other belongings is easy with our in-house vinyl print service. High tack vinyl labels can be applied to most surfaces, including plastic, wood & metal. Using a state of the art Rowland printer, we can print and cut any shape, size and colour label to suit your needs. Great for personalising storage boxes and other equipment, as well as creating an eye-catching, professional look that you and your customers will love.

Suitable for use on:

- Correx Boxes
- Correx Box Lids
- Bespoke Storage Boxes
- Solid Euro Containers
- Solid Euro Cases
- Euro Container Lids
- Ventilated Euro Crates
- Attached Lid Containers
- Crockery Transport Boxes

AVAILABLE TO PURCHASE SEPARATELY

NO SET UP FEES

Vinyl Label Print Options

- Logo printing
- Text/Number printing
- Bar Code printing
- QR Code printing
- Black or White printing
- Colour printing



Base Size: L510 x W360mm

Made from 4mm Corrugated Plastic 650gsm

Colours: ■ ■ ■

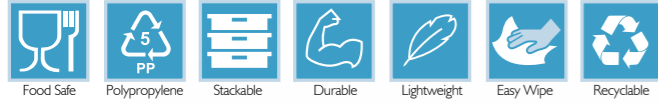

BEST SELLER



Height Options



Lid

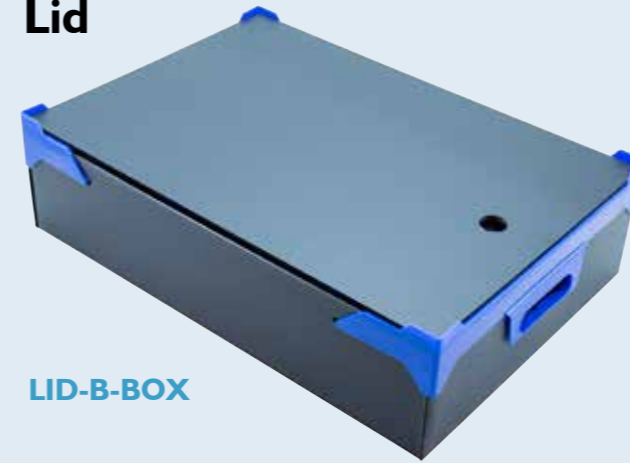

LID-B-BOX

Transport Trolley



TD600-R

Branding

Vinyl Labels

Print Options:



Colours:



Compartment Options

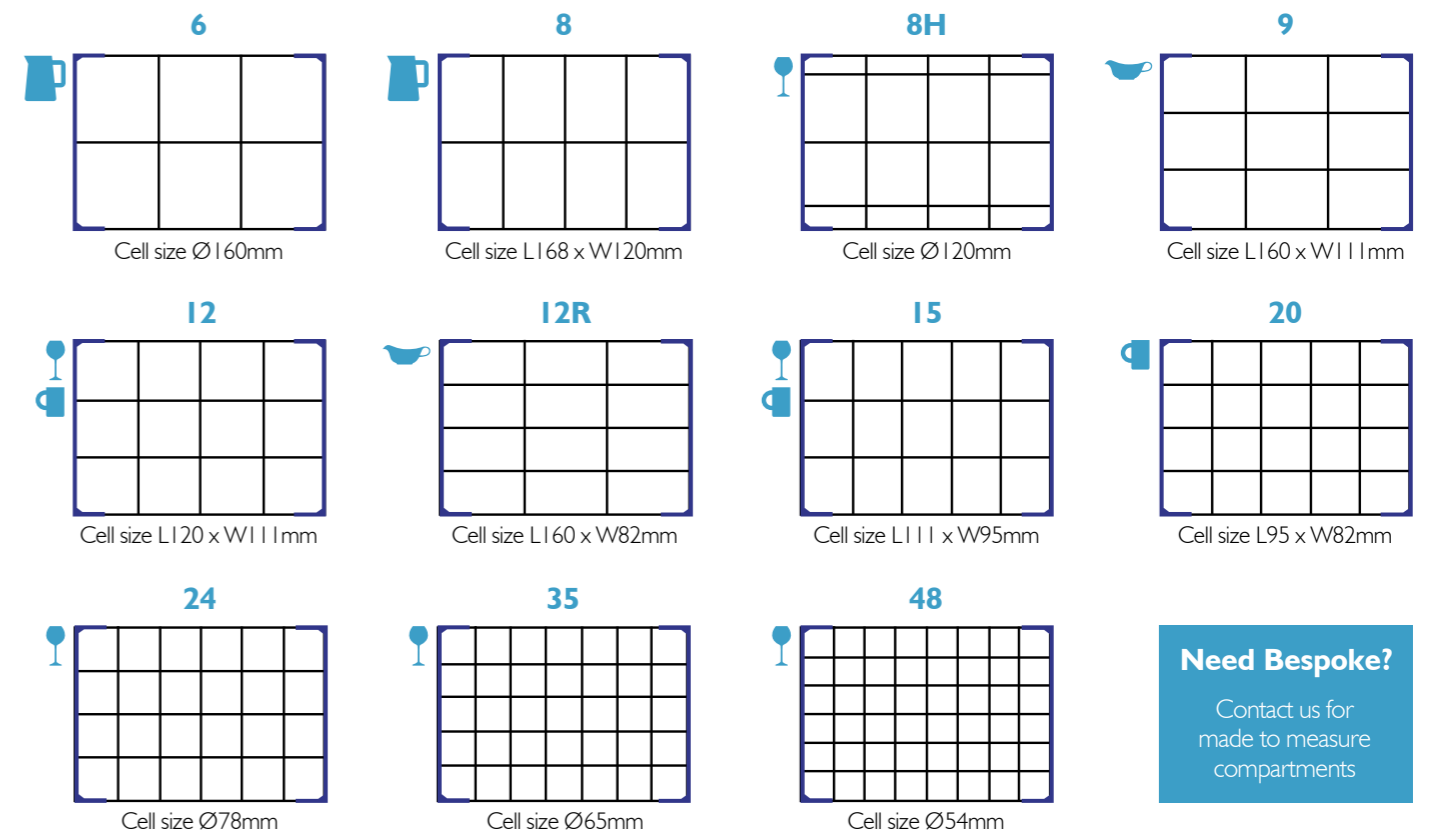

Need Bespoke?

Contact us for made to measure compartments





Base Size: L600 x W400mm



FOR PALLETISATION BENEFITS SEE PAGE 30



BEST SELLER



Reinforced Base



Height Options

S60 60mm L600 x W400 x H75mm	S100 100mm L600 x W400 x H120mm	
S150 150mm L600 x W400 x H175mm	S200 200mm L600 x W400 x H220mm	S250 250mm L600 x W400 x H280mm
S290 290mm L600 x W400 x H320mm	S320 320mm L600 x W400 x H420mm	S380 380mm L600 x W400 x H420mm

Lid Options



LID-64-P Place on Lid
LID-64-H Hinged Lid
LID-64-C Hook on Lid



TD600-R

Branding

Thermal Transfer Print

Print Options: Logo **Abc 123** Text Bar Code QR Code

Colours: Black & White



Compartment Options

6 Cell size Ø175mm	8 Cell size L175 x W135mm	8H Cell size Ø136mm	9 Cell size L183 x W116mm
10 Cell size L175 x W107mm	12 Cell size L137 x W117mm	12R Cell size L183 x W87mm	15 Cell size L117 x W109mm
16 Cell size L137 x W87mm	20 Cell size L110 x W87mm	24 Cell size Ø87mm	28 Cell size Ø77mm
30 Cell size L90 x W69mm	40 Cell size Ø67mm	60 Cell size Ø53mm	

Need Bespoke?
Contact us for made to measure compartments





Base Size: L600 x W400mm



FOR PALLETISATION BENEFITS SEE PAGE 30



GET THIS CRATE BRANDED SEE PAGE 3



Reinforced Base

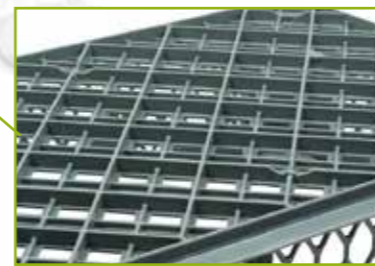

Height Options

V70 70mm L600 x W400 x H100mm			
V100 100mm L600 x W400 x H130mm	V120 120mm L600 x W400 x H150mm	V145 NEW 145mm L600 x W400 x H170mm	
V170 170mm L600 x W400 x H200mm	V195 NEW 195mm L600 x W400 x H220mm	V220 220mm L600 x W400 x H250mm	
V255 255mm L600 x W400 x H285mm	V290 NEW 290mm L600 x W400 x H350mm	V320 320mm L600 x W400 x H350mm	

Lid



LID-64-P

Transport Trolley



TD600-B

Antibacterial Net



Code: NET

Branding

Thermal Transfer Print

Print Options:

- Logo
- Text (Abc 123)
- Bar Code
- QR Code

Colours: Black & White



Compartment Options

6 Cell size Ø180mm	8 Cell size L180 x W138mm	8H Cell size Ø140mm	9 Cell size L187 x W121mm
10 Cell size L180 x W109mm	12 Cell size L140 x W121mm	12R Cell size L187 x W90mm	15 Cell size L121 x W111mm
16 Cell size L140 x W90mm	20 Cell size L111 x W90mm	24 Cell size Ø90mm	28 Cell size Ø79mm
30 Cell size L92 x W71mm	40 Cell size Ø69mm	60 Cell size Ø55mm	

Need Bespoke?
Contact us for made to measure compartments



Base Size: L600 x W400mm



FOR PALLETISATION BENEFITS SEE PAGE 30



NEW



Reinforced Base

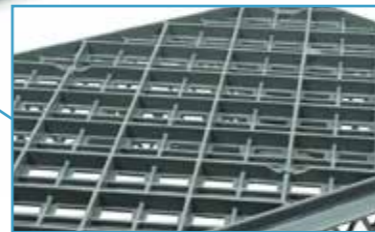

Height Options

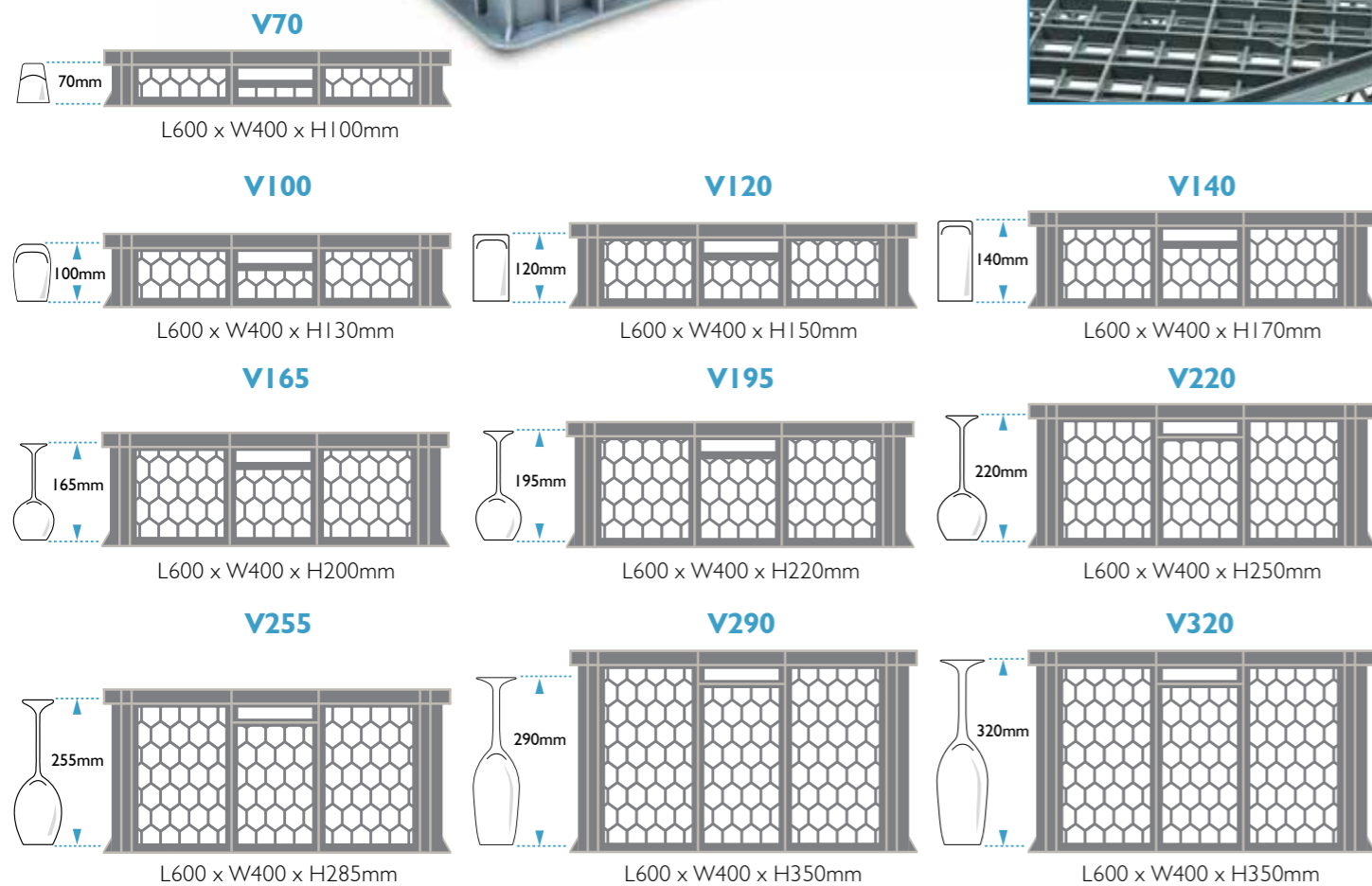

Lid



LID-64-P

Transport Trolley



TD600-B

Antibacterial Net



Code: NET

Branding

Thermal Transfer Print

Print Options:



Colours:



Compartment Options

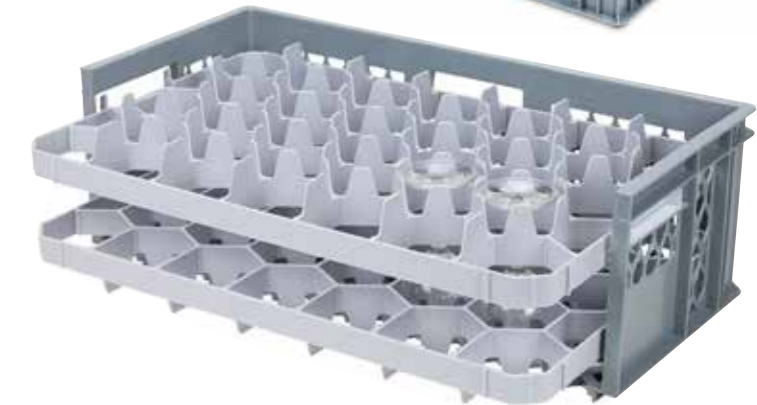
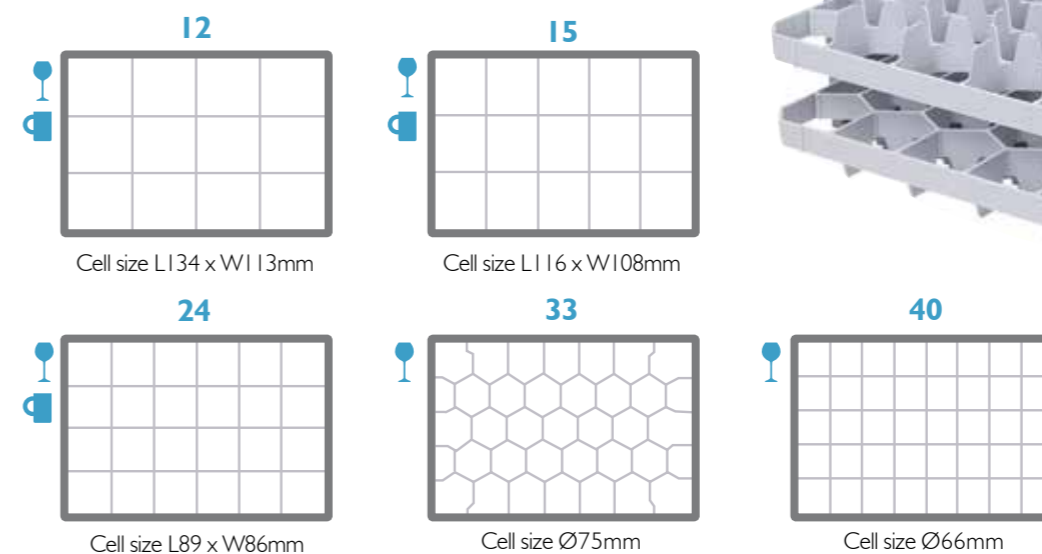



Base Size: L600 x W400mm



FRIES
rack
system

FOR
PALLETISATION
BENEFITS
SEE PAGE 30

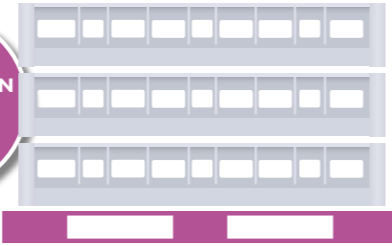

Choose the right rack with the Caterbox Measurement Chart



Height Options

CR600-73



L600 x W400 x H110mm

CR600-120



L600 x W400 x H160mm

CR600-140



L600 x W400 x H180mm

CR600-155

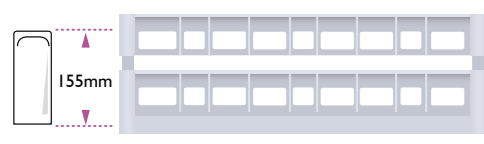

L600 x W400 x H195mm

CR600-170

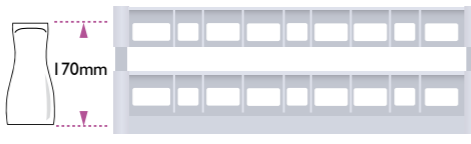

L600 x W400 x H210mm

CR600-185



L600 x W400 x H225mm

CR600-200



L600 x W400 x H240mm

CR600-215



L600 x W400 x H255mm

CR600-230



L600 x W400 x H270mm

TR600-245

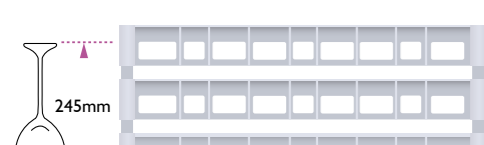

L600 x W400 x H285mm

TR600-260

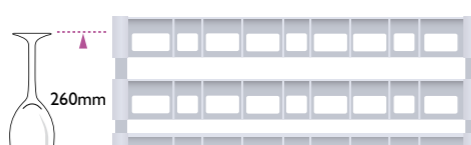

L600 x W400 x H300mm

TR600-285



L600 x W400 x H325mm

Colour Coding

Clips and Frames



Branding

Thermal Transfer Print

Print Options:



Colours:



Mono text only on clips



Compartment Options

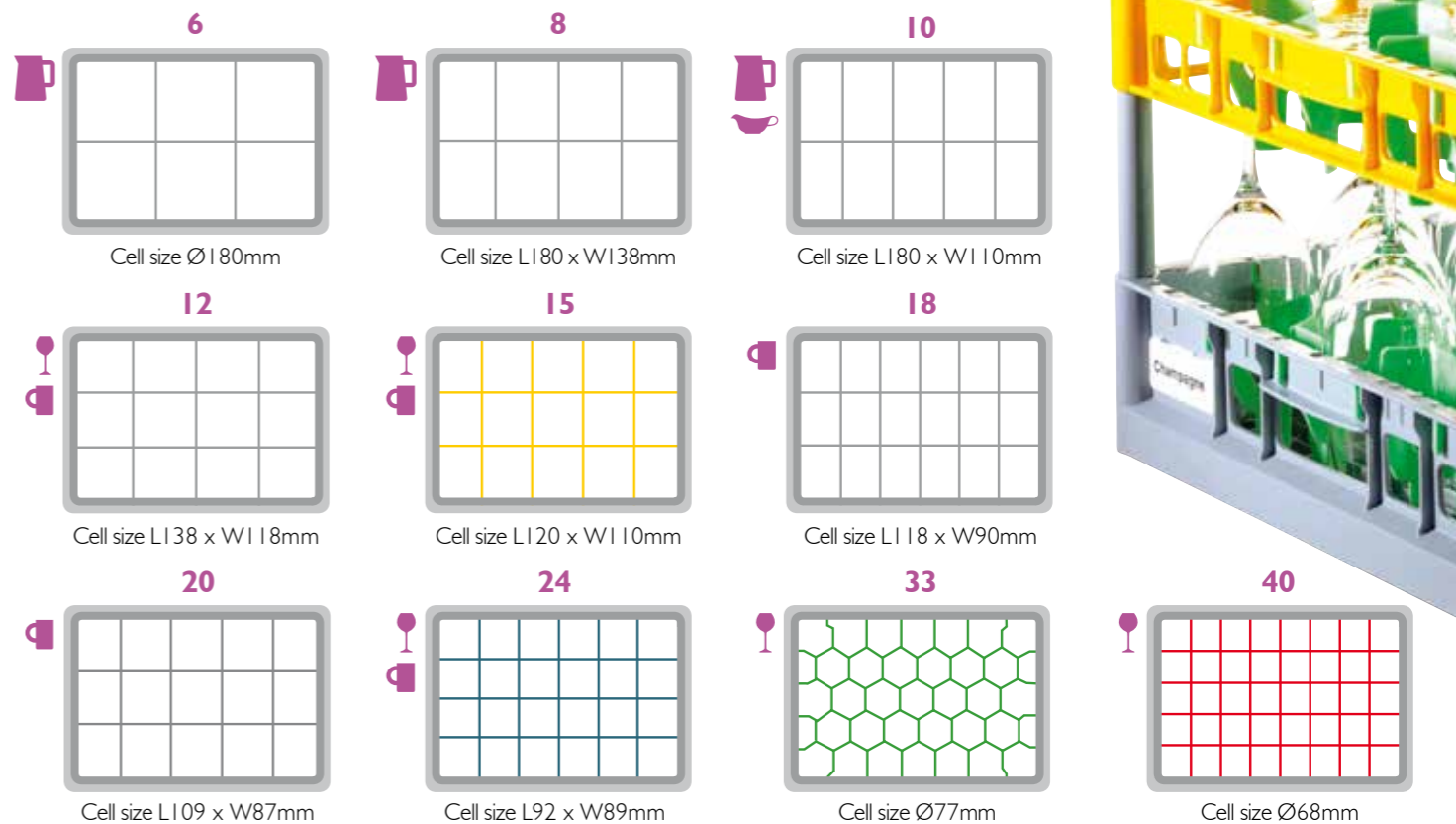



Base Size: L500 x W500mm



FOR
PALLETISATION
BENEFITS
SEE PAGE 30

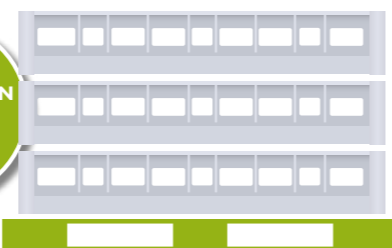

Choose the right rack with the Caterbox Measurement Chart

Height Options

CR500-73



L500 x W500 x H105mm

CR500-120



L500 x W500 x H163mm

CR500-140



L500 x W500 x H183mm

CR500-155



L500 x W500 x H198mm

CR500-170



L500 x W500 x H213mm

CR500-185



L500 x W500 x H228mm

CR500-200



L500 x W500 x H243mm

CR500-215



L500 x W500 x H258mm

CR500-230



L500 x W500 x H273mm

CR500-245



L500 x W500 x H288mm

TR500-260



L500 x W500 x H303mm

TR500-290



L500 x W500 x H333mm

AVAILABLE WITH MIDDLE FRAME

Colour Coding

Clips and Frames



Drip Tray



Champagne



AWAT

Branding

Thermal Transfer Print

Print Options:



Colours:



Mono text only on clips



Compartment Options

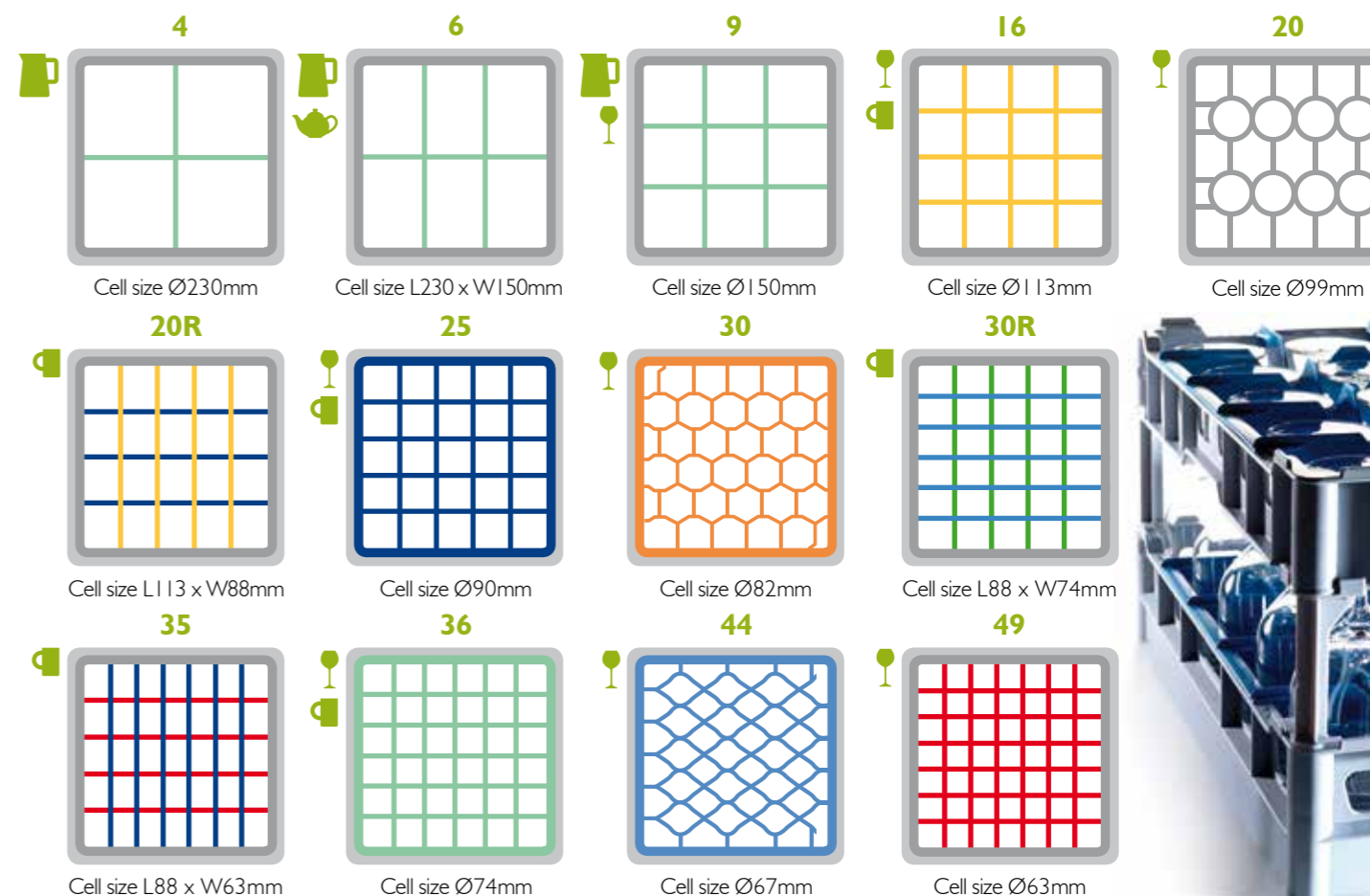



Base Racks (L500 x W500mm)



CR500
Wide mesh base rack for washing cups and similar items, Internal height 75mm

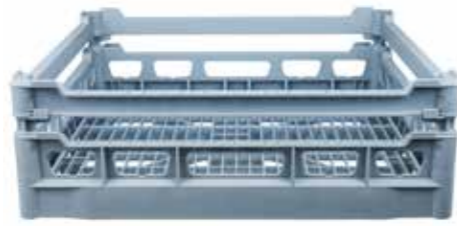

CR500-120
Wide mesh base rack for washing loose barware, Internal height 120mm



CR500-170
Raised base rack, Internal height 170mm other heights available up to 245mm



NK1
Wide mesh base rack with one open side



NK2
Wide mesh base rack with two open side



ADAPTER-RACK
Adaptor rack for 600 x 400mm racks to go through 500mm conveyor washing systems

Cup Racks (L500 x W500mm)

MORE HEIGHTS AVAILABLE



CR500-73/16
Base rack with compartments for 16 cups
Cell size: L113 x W113 x H73mm



CR500-73/20R
Base rack with compartments for 20 cups
Cell Size: L113 x W88 x H73mm



CR500-73/25
Base rack with compartments for 25 cups
Cell Size: L90 x W90 x H73mm



CR500-73/30R
Base rack with compartments for 30 cups
Cell Size: L88 x W74 x H73mm



Plastic coated wire inserts for tilting cups in 500mm base rack
TE3 3 Rows - 160mm layer
TE4 4 Rows - 100mm layer
TE5 5 Rows - 80mm layer



Stainless steel retaining grid prevents movement of lightweight items during washing and rinsing
NHG500
Sits on top of the rack
NHG460
Sits inside the rack

Plate Racks (L500 x W500mm)



PRB
For 18 flat plates or 12 deep plates

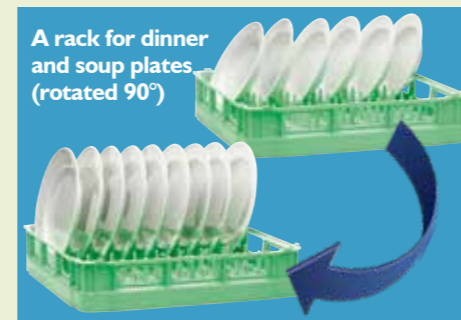

A rack for dinner and soup plates (rotated 90°)



UK
For 16 flat plates or 12 deep plates



BR500PTE
Base rack with removable plastic coated wire insert for 9 large plates



P15
With open base for 15 large plates from Ø180mm

Tray Racks (L500 x W500mm)



T-06-09
Single open sided rack for 9 oversize trays



UKT
Single open sided rack for 9 industrial trays, reinforced with stainless steel rail



NKI-T
Single open sided rack with removable plastic coated wire insert for 9 trays - Row width: 39mm



NK2-GNI/1
Double open sided rack with removable plastic coated wire insert for 9 trays.
Row size: L530 x W37mm



NKI-WHT4
Single open sided rack with removable stainless steel insert for 4 insulated meal trays.
Row width: 95mm



NKI-WHT5
Single open sided rack with removable stainless steel insert for 5 insulated meal trays.
Row width: 75mm



Dishwasher Baskets (L500 x W500mm)



R500
Glasswasher Basket
for washing loose glassware.
Internal size: L460 x W460 x H150mm

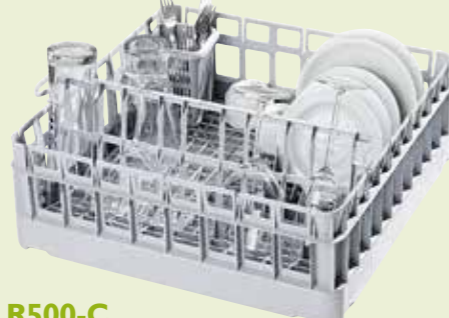

R500-C
Combination Dishwasher Basket
with plate insert, cutlery basket and reclined glass insert



R500-5GR
Glasswasher Basket
with 5 glass recliners, max glass diameter for row 1: 95mm, rows 2-5: 75mm

R500-4GR
Glasswasher Basket
with 4 glass recliners, max glass diameter for row 1: 110mm, rows 2-4: 95mm

Dishwasher Basket Accessories



GR500
Glass Reclining Insert for tilting glasses

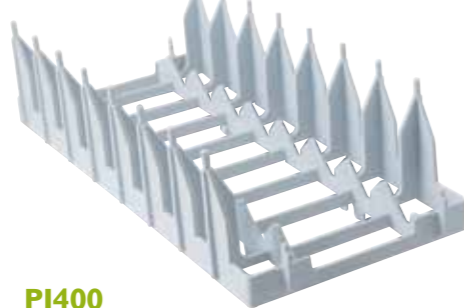

PI400
Plate Insert for 9 plates



AWAT
Drip Tray suitable for counters - can also be used as a cover. **Size:** 500 x 500mm

Cutlery Baskets



CTR
Cutlery Rack with narrow meshed base
Size: L500 x W500 x H105mm



CBS
Cutlery Basket
Size: L110 x W110 x H140mm



BKS
Cutlery Basket with 8 compartments
Size: L450 x W212 x H260mm



CBS4
Cutlery Basket with 4 compartments, available with handle
Size: L220 x W235 x H140mm



Glasswasher Racks

Base Size: L400 x W400mm



Height Options

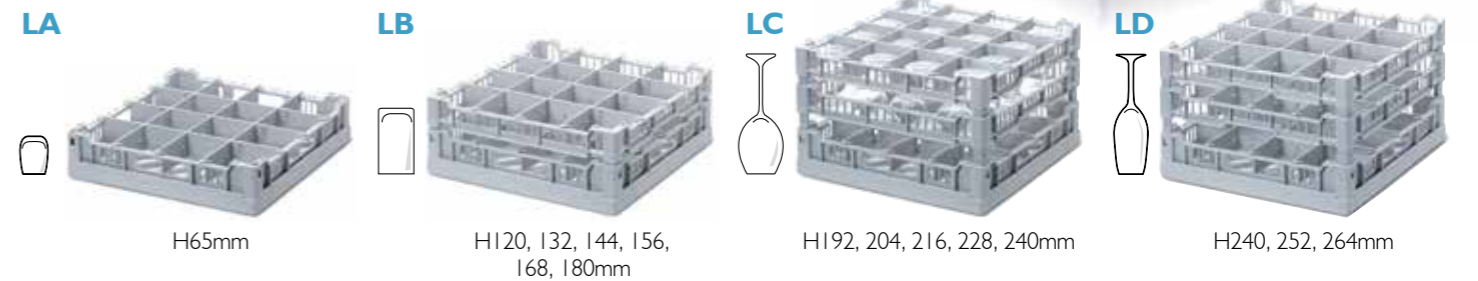

Drip Tray



AW 400
Drip Tray suitable for counters
Size: 400 x 400mm

Compartment Options

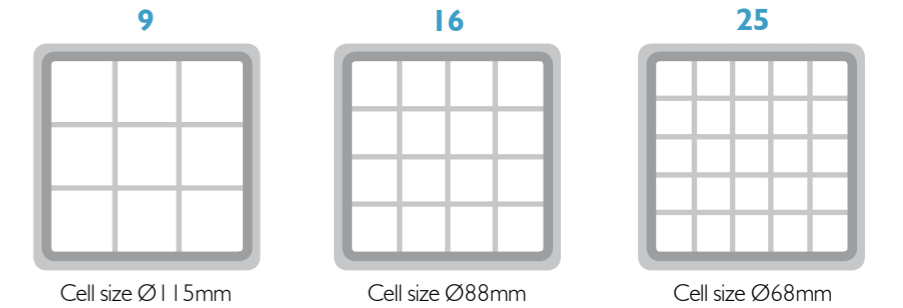

Glasswasher Baskets



R350 (L350 x W350mm)
Internal size: L320 x W320 x H105mm

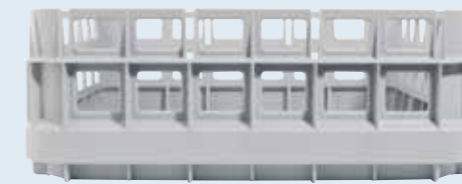

R390 (L390 x W390mm)
Internal size: L360 x W360 x H125mm



R396 (L396 x W396mm)
Internal size: L360 x W360 x H125mm

SETS AVAILABLE

Accessories



GR400
Glass Recliner Insert for tilting glasses (for R 390-400 only)

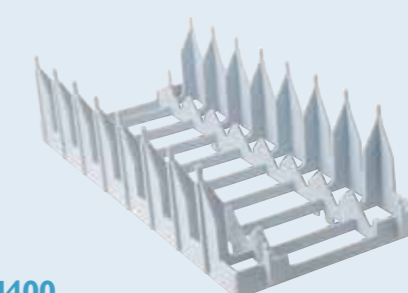

PI400
Plate Insert for 9 plates (for R 390-400 only)



CBS
Cutlery Basket



Base Size: L400 x W300mm



NEW

Reinforced Base

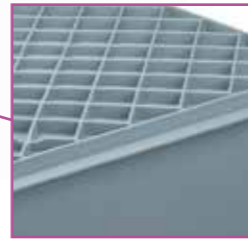

Height Options

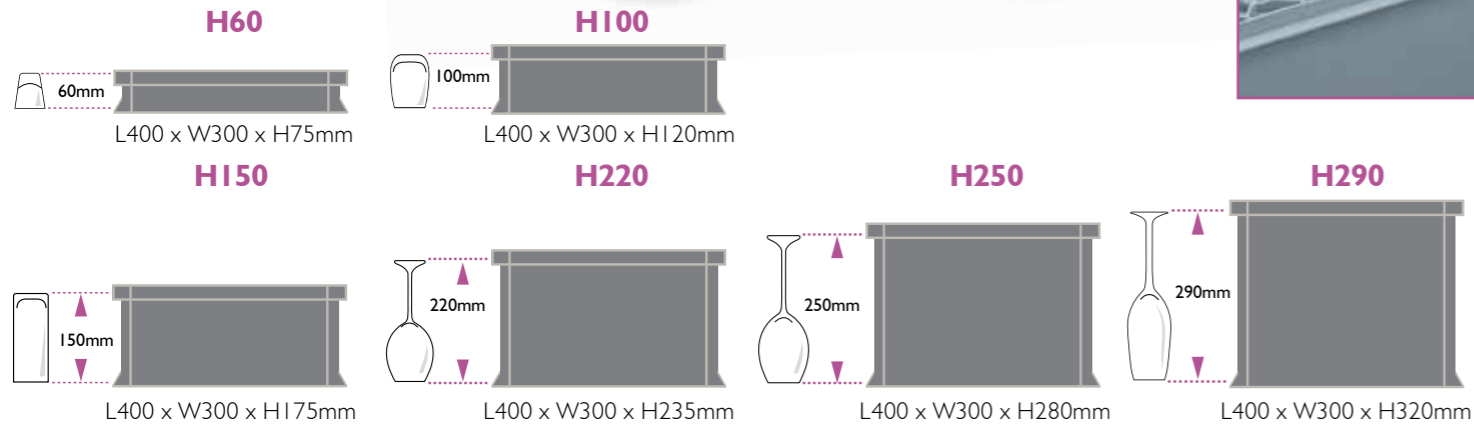

Compartment Options

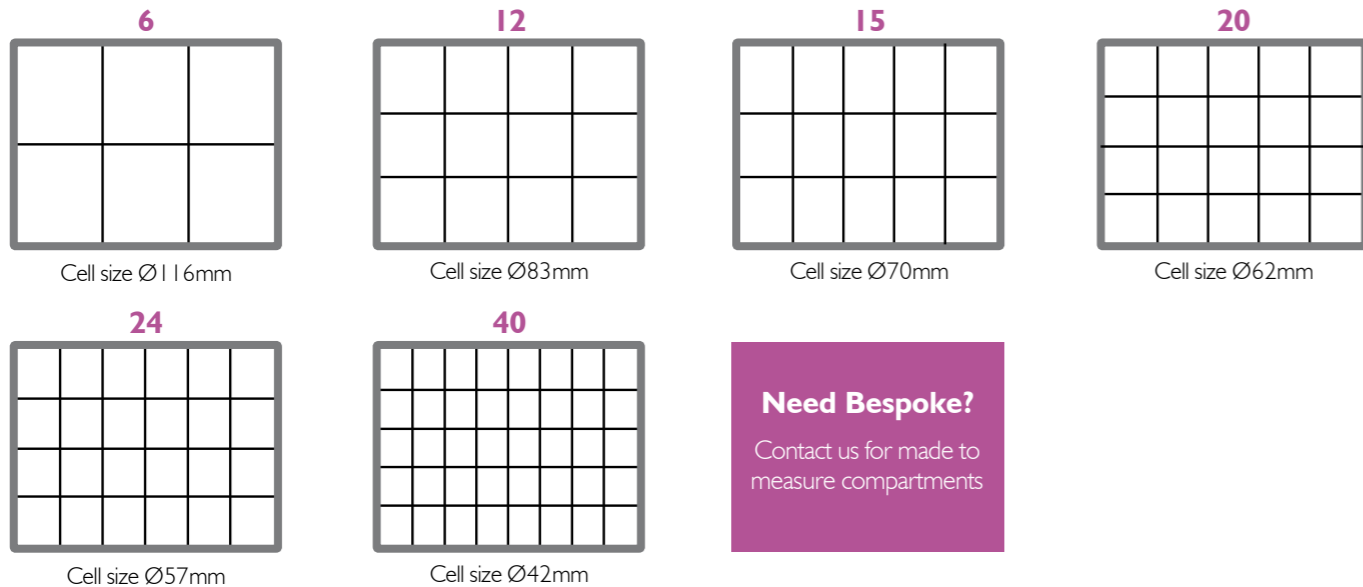

Need Bespoke?
Contact us for made to measure compartments

Cutlery Storage Tray



CT4-G
Cutlery Tray
Size: L530 x W320 x H100mm

Cutlery Storage Boxes



43120C
Small Cutlery Box
External Size: L400 x W300 x H120mm
Stacked Internal Size: L355 x W255 x H100mm



43175C
Medium Cutlery Box
External Size: L400 x W300 x H175mm
Stacked Internal Size: L355 x W255 x H160mm



43235C
Large Cutlery Box
External Size: L400 x W300 x H235mm
Stacked Internal Size: L355 x W255 x H220mm

Cutlery Storage Cases



32120-HL
Extra Small Cutlery Case
External Size: L300 x W200 x H135mm
Stacked Internal Size: L255 x W155 x H115mm



43120-HL-C
Small Cutlery Case
External Size: L400 x W300 x H135mm
Stacked Internal Size: L355 x W255 x H115mm



43175-HL-C
Medium Cutlery Case
External Size: L400 x W300 x H190mm
Stacked Internal Size: L355 x W255 x H170mm



43235-HL-C
Large Cutlery Case
External Size: L400 x W300 x H250mm
Stacked Internal Size: L355 x W255 x H230mm

400 x 300mm Box Lids



LID-43-P
Place on Lid



LID-43-H
Hinged Lid



LID-43-C
Hook on Lid

Branding

Thermal Transfer Print

Print Options:



Colours:





Circular Plate Storage Boxes (L600 x W400mm)



SI 15/08H
Saucer Box with 8 Cells
Plate Size: up to 140mm
Capacity: approx. 80 plates



SI 15/06
Bowl & Saucer Box with 6 Cells
Plate Size: 141 to 180mm
Capacity: approx. 60 plates



SI 15/03T
Side Plate Box with 3 Cells
Plate Size: 181 to 215mm
Capacity: approx. 30 plates



SI 15/02
Tableware Box with 2 Cells
Plate Size: 216 to 250mm
Capacity: approx. 20 plates



SI 15/02H
Dinner Plate Box with 2 Cells
Plate Size: 251 to 280mm
Capacity: approx. 20 plates



LID-64-P
Box Lid
Lid Size: L600 x W400mm

BEST SELLERS

OTHER COMPARTMENT VARIATIONS AVAILABLE

VENTILATED PLATE CRATES ALSO AVAILABLE



43235-O (L400 x W300mm)
Starter Plate Box
Stacked Internal Size: L355 x W255 x H225mm
Plate Size: up to 220mm
Capacity: approx. 40 plates



43280-RO (L400 x W300mm)
Small Dinner Plate Box
Stacked Internal Size: L355 x W255 x H255mm
Plate Size: 221 to 250mm
Capacity: approx. 40 plates

NEW



43320-RO (L400 x W300mm)
10" Plate Box
Stacked Internal Size: L355 x W255 x H295mm
Plate Size: 251 to 280mm
Capacity: approx. 30 plates



43400-RO (L400 x W300mm)
Large Charger Plate Box
Stacked Internal Size: L355 x W255 x H385mm
Plate Size: 281 to 360mm
Capacity: approx. 20 plates

NEW



24025 (L360 x W360mm)
12" Plate Box
Stacked Internal Size: L330 x W330 x H255mm
Plate Size: 281 to 330mm
Capacity: approx. 20 plates

BEST SELLER



CB36/24 (L390 x W390mm)
Charge Plate Box
Stacked Internal Size: L360 x W360 x H230mm
Plate Size: 331 to 360mm
Capacity: approx. 20 plates

Rectangular Plate Storage Boxes (L600 x W400mm)



SI 15/05R
Rectangular Plate Box with 5 Cells
Compartment Size: L300 x W110mm
Capacity: approx. 50 plates



SI 15/04R
Rectangular Plate Box with 4 Cells
Compartment Size: L300 x W138mm
Capacity: approx. 40 plates



SI 15/03R
Rectangular Plate Box with 3 Cells
Compartment Size: L300 x W185mm
Capacity: approx. 30 plates



SI 15/04
Small Plate Box with 4 Cells
Compartment Size: L280 x W180mm
Capacity: approx. 40 plates



SI 15/08
Small Plate Box with 8 Cells
Compartment Size: L180 x W138mm
Capacity: approx. 80 plates

Transport Trolley



TD600-B

WITH BRAKES

Crockery Transport Box

Base Size: L400 x W400mm



CTB4
Cup & Saucer Box with 4 Compartments
Plate Size: up to 160mm
Capacity: 56 stacking cups & saucers



CTB2
Starter Plate Box with 2 Tube Insert
Plate Size: 161 to 190mm
Capacity: 60 plates



CTB1
Plate Box with Tube Insert
Plate Size: 191 to 330mm
Capacity: 25 plates



CTB
Crockery & Food Box
Internal Size: L330 x W330 x H270mm
Capacity: 25 plates / 32L



FOR BOX
BRANDING
SEE PAGE 3



L400 x W300mm



43075
Ext: L400 x W300 x H75mm
Int: L355 x W255 x H72mm
Base Type: Smooth Base



43120
Ext: L400 x W300 x H120mm
Int: L355 x W255 x H117mm
Base Type: Smooth Base



43175
Ext: L400 x W300 x H175mm
Int: L355 x W255 x H172mm
Base Type: Smooth Base



43235
Ext: L400 x W300 x H235mm
Int: L355 x W255 x H232mm
Base Type: Smooth Base



43280
Ext: L400 x W300 x H280mm
Int: L355 x W255 x H265mm
Base Type: Reinforced Base



43320
Ext: L400 x W300 x H320mm
Int: L355 x W255 x H305mm
Base Type: Reinforced Base



43400
Ext: L400 x W300 x H400mm
Int: L355 x W255 x H385mm
Base Type: Reinforced Base



LID-43
Box Lid
Lid Size: L400 x W300mm



L400 x W300mm



43075-CASE
Ext: L400 x W300 x H90mm
Int: L355 x W255 x H72mm
Base Type: Smooth Base



43120-CASE
Ext: L400 x W300 x H135mm
Int: L355 x W255 x H117mm
Base Type: Smooth Base



43175-CASE
Ext: L400 x W300 x H190mm
Int: L355 x W255 x H172mm
Base Type: Smooth Base



43235-CASE
Ext: L400 x W300 x H250mm
Int: L355 x W255 x H232mm
Base Type: Smooth Base



43320-CASE
Ext: L400 x W300 x H335mm
Int: L355 x W255 x H305mm
Base Type: Reinforced Base



43400-CASE
Ext: L400 x W300 x H415mm
Int: L355 x W255 x H385mm
Base Type: Reinforced Base



L600 x W400mm



64075
Ext: L600 x W400 x H75mm
Int: L555 x W355 x H72mm
Base Type: Smooth Base



64120
Ext: L600 x W400 x H120mm
Int: L555 x W355 x H117mm
Base Type: Smooth Base



64175
Ext: L600 x W400 x H175mm
Int: L555 x W355 x H172mm
Base Type: Smooth Base



64220
Ext: L600 x W400 x H220mm
Int: L555 x W355 x H217mm
Base Type: Smooth Base



64280
Ext: L600 x W400 x H280mm
Int: L555 x W355 x H265mm
Base Type: Reinforced Base



64320
Ext: L600 x W400 x H320mm
Int: L555 x W355 x H305mm
Base Type: Reinforced Base



64420
Ext: L600 x W400 x H420mm
Int: L555 x W355 x H405mm
Base Type: Reinforced Base



LID-64
Box Lid
Lid Size: L600 x W400mm

L600 x W400mm



64075-CASE
Ext: L600 x W400 x H90mm
Int: L555 x W355 x H72mm
Base Type: Smooth Base



64120-CASE
Ext: L600 x W400 x H135mm
Int: L555 x W355 x H117mm
Base Type: Smooth Base



64175-CASE
Ext: L600 x W400 x H190mm
Int: L555 x W355 x H172mm
Base Type: Smooth Base



64220-CASE
Ext: L600 x W400 x H235mm
Int: L555 x W355 x H217mm
Base Type: Smooth Base



64280-CASE
Ext: L600 x W400 x H295mm
Int: L555 x W355 x H265mm
Base Type: Reinforced Base



64320-CASE
Ext: L600 x W400 x H335mm
Int: L555 x W355 x H305mm
Base Type: Reinforced Base

Branding

Thermal Transfer Print

Print Options:



Colours:



Lid Options

Lid Sizes:
L400 x W300mm
L600 x W400mm



Place on Lid

Hinged Lid

Hook on Lid

Handles



Shell Handle

Open Handle

Smooth Base

Reinforced Base



FOR BOX
BRANDING
SEE PAGE 3



Ventilated Euro Crates

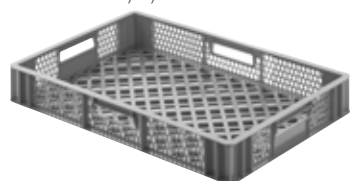

V70 ■ ■ ■
Ext: L600 x W400 x H100mm
Int: L567 x W367 x H85mm

V100 ■ ■ ■ ■
Ext: L600 x W400 x H130mm
Int: L567 x W367 x H115mm

V120 ■ ■ ■ ■
Ext: L600 x W400 x H150mm
Int: L567 x W367 x H135mm

V145 ■ ■ ■ ■
Ext: L600 x W400 x H170mm
Int: L567 x W367 x H155mm

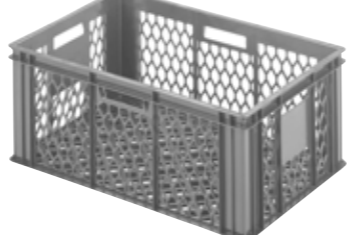
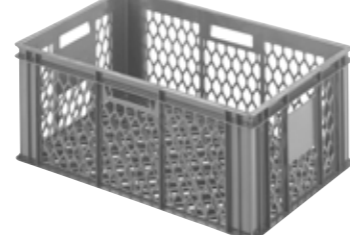
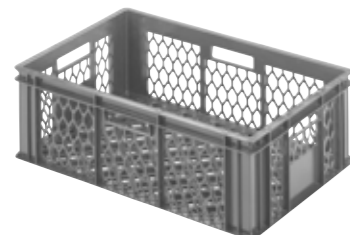

V170 ■ ■ ■ ■
Ext: L600 x W400 x H200mm
Int: L567 x W367 x H185mm

V195 ■ ■ ■ ■
Ext: L600 x W400 x H220mm
Int: L567 x W367 x H205mm

V220 ■ ■ ■ ■
Ext: L600 x W400 x H250mm
Int: L567 x W367 x H235mm

V255 ■ ■ ■ ■
Ext: L600 x W400 x H285mm
Int: L567 x W367 x H270mm

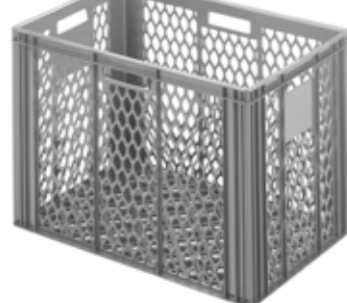
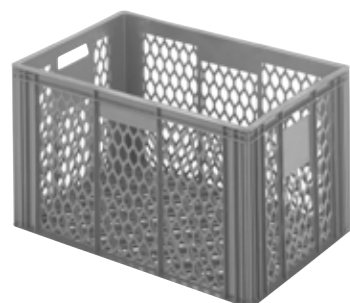

V320 ■ ■ ■ ■
Ext: L600 x W400 x H350mm
Int: L567 x W367 x H335mm

V380 ■ ■ ■ ■
Ext: L600 x W400 x H420mm
Int: L567 x W367 x H405mm

LID-64-P ■ ■ ■ ■
Box Lid
Lid Size: L600 x W400mm

Folding Crates

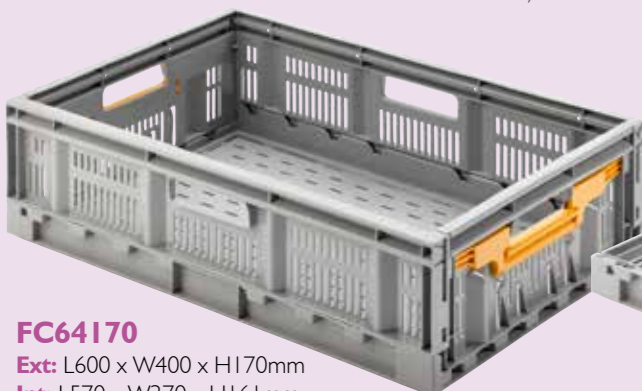

FC64170
Ext: L600 x W400 x H170mm
Int: L570 x W370 x H161mm



FC64220
Ext: L600 x W400 x H220mm
Int: L570 x W370 x H211mm

40mm

Correx Boxes



B80 ■ ■ ■ ■
Ext: L510 x W360 x H100mm
Int: L490 x W340 x H80mm

B120 ■ ■ ■ ■
Ext: L510 x W360 x H145mm
Int: L490 x W340 x H120mm

B160 ■ ■ ■ ■
Ext: L510 x W360 x H180mm
Int: L490 x W340 x H160mm

B190 ■ ■ ■ ■
Ext: L510 x W360 x H215mm
Int: L490 x W340 x H190mm

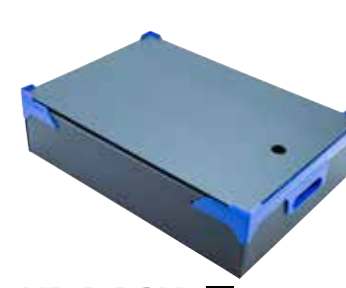

B220 ■ ■ ■ ■
Ext: L510 x W360 x H250mm
Int: L490 x W340 x H220mm

B260 ■ ■ ■ ■
Ext: L510 x W360 x H280mm
Int: L490 x W340 x H260mm

B300 ■ ■ ■ ■
Ext: L510 x W360 x H330mm
Int: L490 x W340 x H300mm

LID-B-BOX ■ ■ ■ ■
Box Lid
Lid Size: L510 x W360

Attached Lid Containers

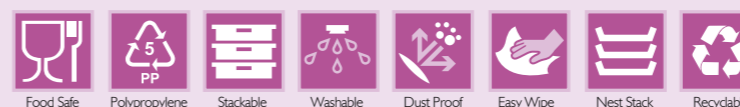

D425
Ext: L400 x W300 x H250mm
Int: L370 x W270 x H230mm

D435
Ext: L400 x W300 x H350mm
Int: L370 x W270 x H330mm



D625
Ext: L600 x W400 x H265mm
Int: L548 x W370 x H245mm

D635
Ext: L600 x W400 x H365mm
Int: L570 x W370 x H345mm





MADE TO MEASURE DIVIDERS AVAILABLE



Max Box Size: L970 x W970mm

Minimum Order: 10 Boxes

Made from 4mm ridged fluted plastic, 10mm PVC foamex frames, reinforced with metal corners and steel rivets.



Branding
Vinyl Labels



SEE BRANDING OPTIONS PAGE 3

Correx Box Dividers

Material: 4mm Corrugated Plastic 650gsm. **Divider Size:** L490 x W340mm

Divider Height Options

80mm	120mm	160mm	190mm	220mm	260mm
300mm					

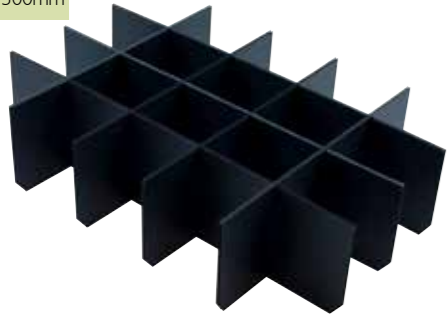

Compartments		
	Length	Width
6	168mm	160mm
8	168mm	120mm
8H	120mm	120mm
12	120mm	111mm
15	111mm	95mm
18	111mm	78mm
20	95mm	82mm
24	82mm	78mm
35	66mm	65mm
48	58mm	54mm

Ventilated Crate Dividers

Material: 2mm & 5mm Polypropylene. **Divider Size:** L563 x W363mm

Divider Height Options

70mm	100mm	120mm	145mm	170mm	195mm
220mm	255mm	290mm	320mm	380mm	

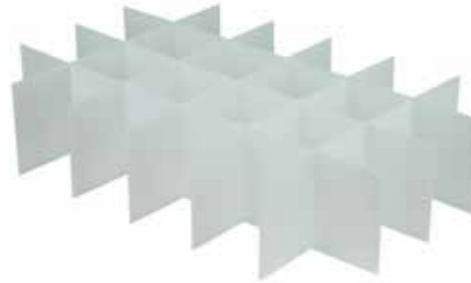

Compartments		
	Length	Width
6	185mm	180mm
8	180mm	138mm
12	140mm	121mm
15	121mm	111mm
20	111mm	90mm
24	92mm	90mm
28	90mm	79mm
30	92mm	71mm
35	79mm	71mm
40	71mm	69mm
60	59mm	55mm

600x400 Euro Container Dividers

Material: 2mm & 5mm Polypropylene. **Divider Size:** L553 x W353mm

Divider Height Options

60mm	100mm	115mm	150mm	200mm	250mm
290mm	320mm	380mm			

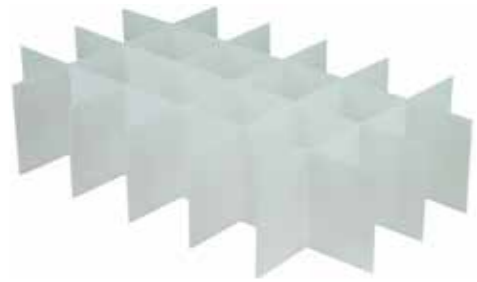

Compartments		
	Length	Width
6	180mm	175mm
8	175mm	135mm
12	137mm	117mm
15	117mm	109mm
20	110mm	87mm
24	90mm	87mm
28	87mm	77mm
30	90mm	69mm
40	69mm	67mm
60	57mm	53mm

400x300 Euro Container Dividers

Material: 2mm & 3mm Polypropylene. **Divider Size:** L353 x W253mm

Divider Height Options

60mm	100mm	150mm	220mm	250mm	290mm
360mm					



Compartments		
	Length	Width
6	126mm	116mm
12	87mm	83mm
15	83mm	70mm
20	69mm	62mm
24	62mm	57mm
40	49mm	42mm
48	42mm	40mm

Top & Bottom Crate Dividers

Material: Mould Injected Polypropylene
For use in Caterbox 600x400 Ventilated Crates



Compartments		
	Length	Width
12	134mm	113mm
15	116mm	108mm
24	89mm	86mm
33	75mm	75mm
40	66mm	66mm

Divider Strips

Material: 3mm Polypropylene
Snap to size to fit any box, slot for every 14mm



Compartments		
Code	Height	Length
STRIP-45	45mm	1100mm
STRIP-88	88mm	1100mm
STRIP-150	150mm	1100mm
STRIP-190	190mm	1100mm



Bespoke Box Options



Box Only



Box with Dividers



Box with Place On Lid



Box with Hinged Lid

Ideal for storing Martini Vases, Lily Vases or any Glass Vases, Candelabras, Chandeliers, Candlesticks, Chafing Dishes, Catering Equipment and any other oversized Event Hire Equipment such as Lanterns, Plinths, Trays, Ice Buckets, Seat Pads and even Water-Boilers.



Transport Trolleys



TD500
Transport Trolley with four castors.



ROL500
Transport Trolley with removable drip tray and four castors.



TD600-R
Transport Trolley with four castor wheels



TD600-B
Transport Trolley with four castor wheels and two brakes



ROLB500
Transport Trolley with push bar, removable drip tray and four castors.



DROLB500
Rack Cart with two push bar, removable drip trays and two brakes.

Efficient Storage

We stock an extensive range of boxes with most ranges offering a different height for every 15mm that's 1.5cm! In hand with this our box dividers are just as extensive helping you get as many glasses in a box as possible. Less boxes are needed freeing up unnecessary occupied storage space.



Palletisation



Suitable for 600 x 400mm Boxes and Racks



Suitable for 500 x 500mm Dishwasher Racks

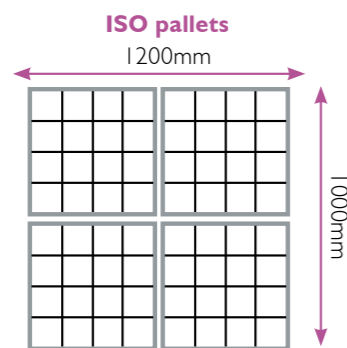
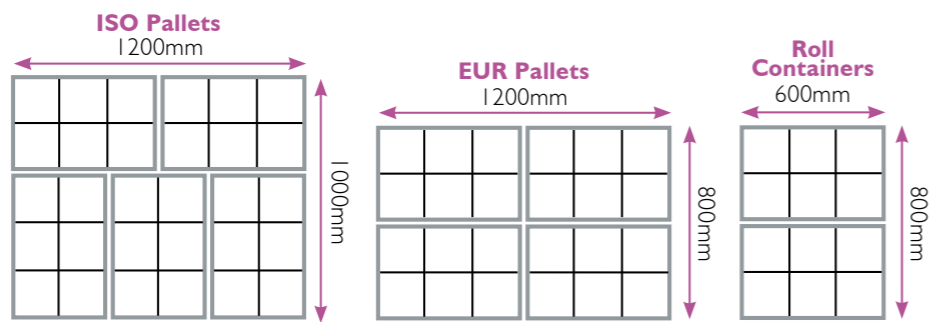

We know how important it is to be economical with glass and chinaware storage and transportation, that's why all our storage boxes are of European standard sizes make logistics a breeze.

Glass Measurement Guide

Step 1. Measure the height of the glass.



Step 2. Measure the width of the glass at the widest point.

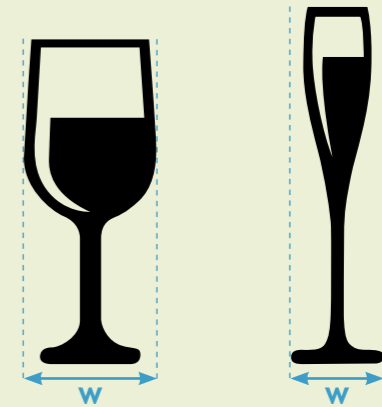

Cup Measurement Guide

Step 1. Measure the height of the cup.



Step 2. Measure the diameter of the cup

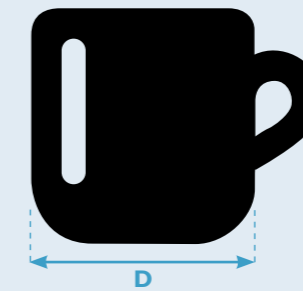

Step 3. Measure the width of the cup including the handle.

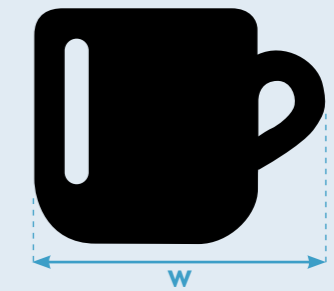
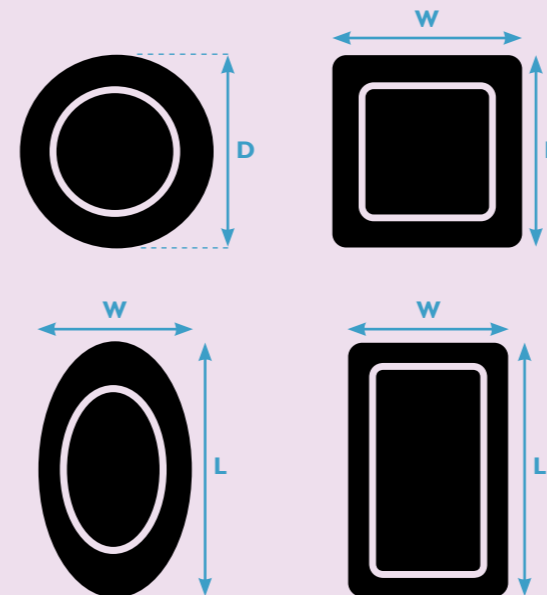
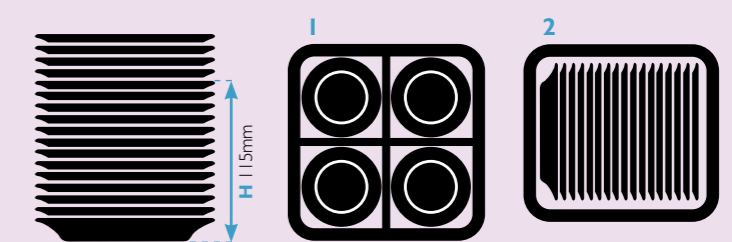

Plate Measurement Guide

Step 1. Measure the diameter on circular plates or the length and width on other plates.



Step 2. To find out the box capacity, take note of the internal space available and how the plates can be stored in your chosen box.



Example 1
This box stores plates flat. Take note of the internal height of the compartment, then measure a stack of plates up to that point. Multiply the number of plates by the number of compartments of the box.
For example, the compartment is 115mm high, measure a stack of plates up to 115mm, counting the plates below this point. Then multiply that number by the 4 compartments.

Example 2
This box stores plates on the rim lengthways. Take note of the internal length of the box, then measure a stack of plates up to that point.
NOTE: Some boxes store plates widthways so the internal width will be needed.



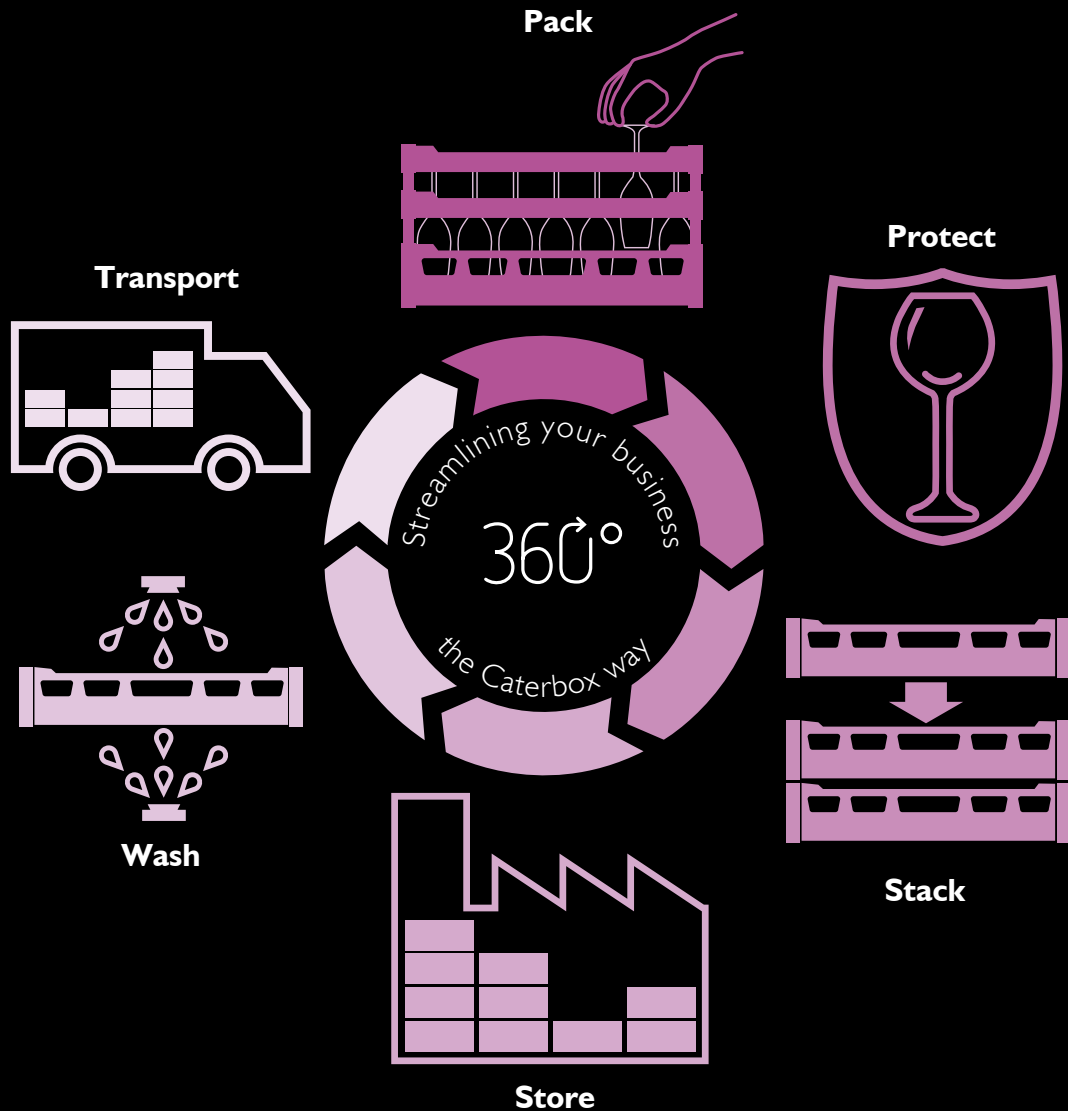

Caterbox[®]
Pack. Protect. Store.

☎ 01962 711007

✉ sales@caterbox.co.uk

🌐 www.caterbox.co.uk

📍 **Caterbox** Unit 16b, Hazeley Road,
Twyford, Winchester, UK, SO21 1QA

