

ERack 3[®]

cp cases 

- 30 years of design evolution and compliant to MIL-STD-810
- Designed and manufactured in our own factory
- Hundreds of application options – customisation is our forte
- Short lead times and fast track delivery



Introducing ERack 3

Customers rely on our ruggedised ERack transit enclosures to protect their 19" rack mounted electronics in extreme conditions. Design improvements embodied in our new ERack bring further advantages to this successful product, most importantly the ability to economically customise and introduce application features for specific customer requirements.

With the product made completely in-house, the full efficiency of self-controlled design and manufacture brings short lead times and fully joined up communication from the initial enquiry to the final quality checks and delivery.

New ERack brings many customer advantages in terms of cost, lead times and design flexibility.

Index	
Overview	
Introducing ERack 3 and Showcase	1
Why Choose New ERack 3?	2
Easily Customised – from Start to Finish	8
Key New Features	10
Technical	
Size List	20
Sizes and Case Numbering System	21
Accessories	22
Other CP Products	24

Showcase



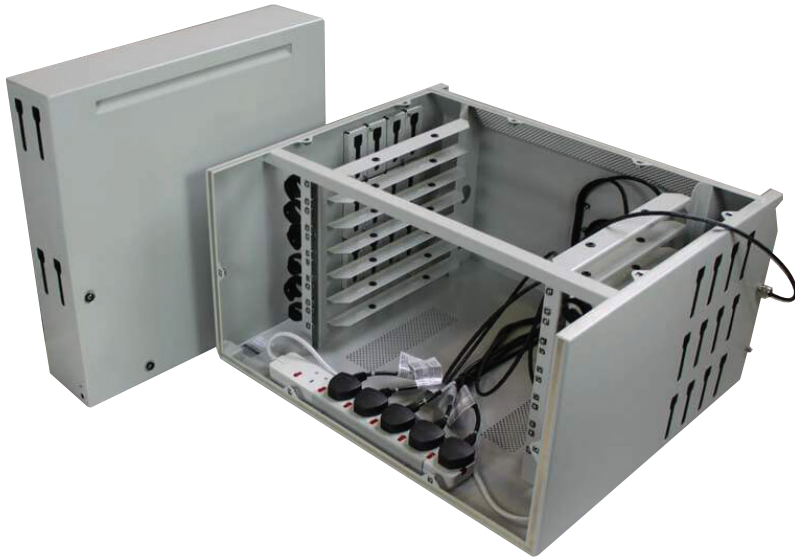

Armed Forces – Naval



Armed Forces – Land



Armed Forces - Air



Broadcast



Satellite Communications



Science and Research

Why Choose ERack 3?

This new innovative ERack builds on the successes of previous ERack designs and offers the user a wide range of benefits. Designed for both commercial and military applications, this 19" ruggedised electronic transit rack offers protection against physical, climatic and electromagnetic hazards and is constructed from high-tensile aluminium alloy, making ERack ideal where weight, strength and portability are critical issues.

Unique internal 19" chassis (frame) design

The unique design of the internal chassis is created from RoHS compliant, high-tensile, aluminium alloy and means that ERack delivers enhanced lightness, rigidity and durability.

ERack enclosures incorporate the innovative lightweight CV2 high tensile extruded 19" chassis – designed to give torsional rigidity and stiffness when under severe loads. Resistant to shock, drop, impact, and vibration; it is certified to MIL-STD-810.

The CV2 internal chassis is has exceptionally rigid torsional strength, achieved by unique (Patented) extrusion designs, incorporating multiple triangular hollow extruded sections from high tensile aluminium to achieve an extraordinarily high strength to weight ratio. Triangular hollow sections are the structural engineers preferred section of choice when it comes to beam strength applications (like bridge building).

Close tolerance CNC machined extrusions lock accurately together to give the assembled CV2 chassis repeatable dimensional accuracy meeting the many international 19" enclosure standards.

The thin sectional extrusions incorporate isosceles triangle geometry to give low weight/high strength ratios, and larger chassis sizes retain their lightweight advantage without compromise on rigidity or payload carrying capacities.

There are 60 standard sizes plus half rack options, all IEC compliant, and sizes from 2U to 18U and 5 standard depths of 350mm / 480mm / 610mm / 740mm and 870mm, with non standard U heights and chassis depths – available on request. CV2 chassis have been separately accredited to MIL-STD-810 drop and vibration testing – test reports are available on request.

Field-replaceable captive M6 stainless steel threaded cage nuts secure equipment and allow for easy switch-out of payload if required. Also available is the Patented stainless steel 'Supanut' which is secured to the chassis vertical members with a unique spring circlip, providing additional resistance to being 'pushed through' by heavy handed operators.



Rigid extruded internal 19" CV2 chassis

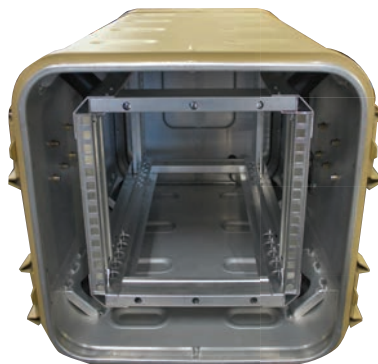

Half rack ERack sizes available in both U heights and chassis depths



Supanut and horseshoe spring circlip



Exceptional construction

ERack's patented monocoque design is constructed from 1.5mm high tensile aluminium alloy, delivering exceptional strength to weight ratio. The 2 part body is seam welded using the very latest synergic pulse TIG technology.

The lids are single aluminium pressings formed from deep drawn tooling, incorporating bonded male/female lid to body engagement with climatic and/or electromagnetic shielding gaskets that provide protection against climatic ingress, EMC and physical impact and vibration.

Calibrated anti-vibration mounts support a rigid internal floating chassis (19" frame) which provides the optimum resistance to physical damage. The increased sway space of >40mm allows the chassis excursion greater controlled movement, while the standard configuration using 8 or 16 elastomeric anti-vibration mounts can be tuned to accommodate various payload weights and varying Centre of Gravity positions.

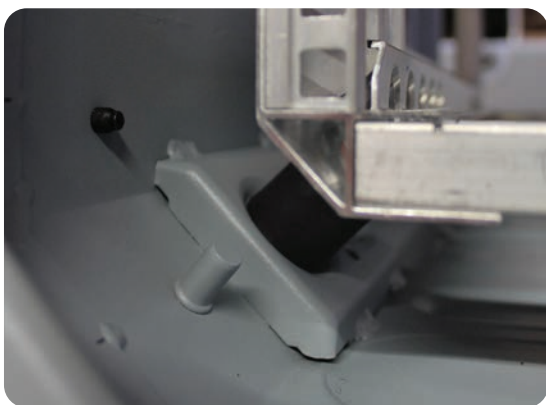

Internal CV2 chassis with **elastomeric AVM** and **welded anchor plate**

Protection against drop, shock and vibration

The robust design and special anti-vibration mounts ensure that electronic equipment is protected against shock, vibration and impact, regardless of orientation.

The floating inner rack chassis is mounted on eight elastomeric mounts, fixed to the outer body by robust anchor plates, which focus towards the centre of mass of the case. There is more than 40mm of sway space around the chassis. The >40mm sway space also provides considerable naturally aspirated 'air space' for ambient air cooling when the lids are removed.

A conductive Earth bond is achieved by attaching a braided metal strap or grounding wire between the chassis and a welded AVM anchor point.

The 45 degree angled elastomeric AVM's provide similar equipment protection characteristics regardless of the enclosure orientation, and are secured to the ERack outer body by welded anchor plates and M8 threaded studs.

ERack can accommodate payloads of up to 50kg in its standard configuration. However, heavier payloads may be accommodated by configuring double elastomeric AVMs or stainless-steel wire rope mounts (further info available on request).

ERack lid pressing prior to 5 axis laser trimming operation

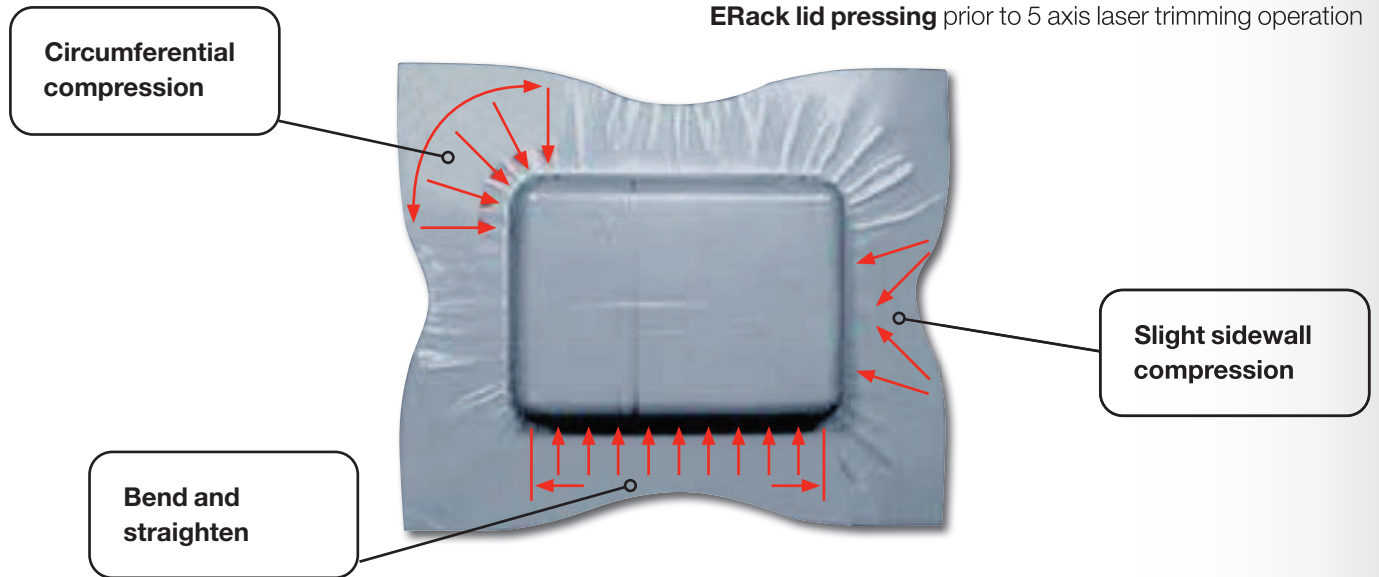

Innovative development – deep drawn lids

Considerable investment in specialised press tooling provides 1 piece lids for all body sizes from 2u to 18u, with non-standard fabricated sizes available. The advantages of a single part, press formed lid gives exceptional rigidity and resistance to torsional flex, there are no leak paths, and offer consistent dimensional accuracy.

ERack lids are manufactured from 1.5mm high tensile aluminium alloy, providing high performing mechanical properties and show very good atmospheric and seawater corrosion resistance. This alloy is used extensively in commercial, military, marine and offshore applications.

The precision tooling for each lid size incorporates removable inserts to accommodate lid options for both recessed rotary latches or non-recessed, side mounted cam operated latches. ERack lids also have low depression removable central insert(s) to maintain lid flatness and options to fit low profile connectors. Cold forming of the lids work hardens the structure giving enhanced stiffness and rigidity.

The flat blank is deep drawn to a depth of >70mm, and designed to maximise material thickness around the corners and drawn sides. Accurately trimming the drawn sides and cutting any holes (rotary latch spindles or connectors) is carried out on a 5-axis laser to maintain accuracy and repeatability.

Lids are press formed to give stiffness and enhanced rigidity as well as dimensional accuracy. CNC formed male / female extrusions are bonded to the body and lids to ensure a perfect 'mate' – providing the weatherproof silicon gasket with a repeatable compression set.

Removable inserts in lid tooling

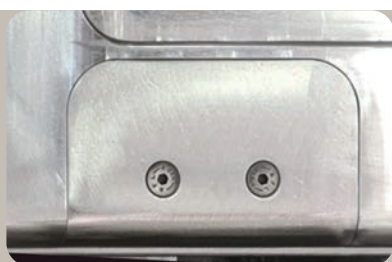

One piece lid forms with low depression stiffening inserts

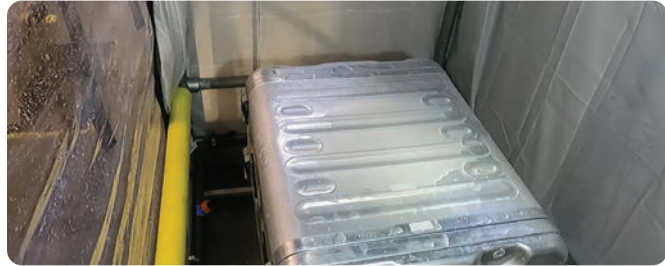

Water test rig delivering 300 Ltrs/min in conical and fantail jets



Internal inspection after water test

Designed and manufactured in-house

At CP Cases it's all about the quality and craftsmanship of the products. By keeping the process in-house, we can maintain a close watch at every stage of the process to give the customer what they expect.

Each customer tests our design and manufacturing capabilities and we are able to demonstrate our ability to understand their application to design and manufacture accordingly. From the customer initial enquiry, right through the design and manufacturing process, we have the engineering skills, the 3D design software and the CNC machinery to make ERack from 'end to end'.

Every part of the process is 'hands on' managed to facilitate accuracy, consistency and short lead times. CP Cases can achieve bespoke manufacturing agility which is especially beneficial to our customers, who can specify and customise their ERack enclosures to dovetail fit their individual application. Detailed discussions with our design team, factory visits during manufacture and pre-delivery inspection are all part of our customer service. We actively encourage our clients to engage with us throughout the manufacturing journey of their ERack enclosures as fully described on pages 8-9.

We continue to invest in material and process development, training young engineers in our unique products and showcasing our facilities in the UK and USA to our loyal customers.

In-house water testing

Every ERack goes through a 20 minute water test. High pressure jets of water are directed at multiple angles to emulate heavy rain conditions. The racks are then inspected to ensure there is no water ingress.

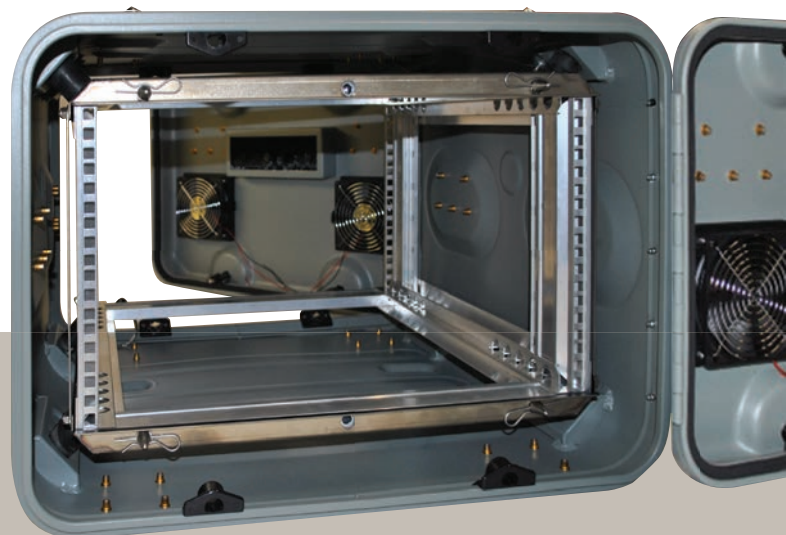

Options of **removable or hinged lids** at both front and rear

Quick release lids and convenient lid stowage

Options on ERack lid fasteners include front operated half turn rotary latches or side positioned surface mounted latches. Both options give the user rapid and easy access to the equipment at both the front and rear of the enclosure. The unique, Patented half turn latches feature fully recessed lobe knobs sculpted for easy grip even when wearing arctic gloves.

Rotary latch stainless steel spindles engage in nylon striker sleeves located in the rack body, pre-aligning them as the lid is placed in position. Helical cams inside the striker sleeves draw the lid evenly to the body, providing optimum guaranteed seal compression. Fully home, the latches are securely located in anti-vibration detents and an elastomer seal on the spindle prevents ingress of contaminants.

Secure lid stowage can be provided by a 'hook and eye' arrangement, whereby the stowed lids are hooked onto the side of the ERack body. Both front and rear lids can be accommodated, ensuring safe operational storage and easy lid removal and replacement.



Cable management

We understand our customers requirements on cabling and cable management. The need to allow space for restricted cable bend radii, cable looms and harness fixing locations within the ERack enclosure, without compromising the sway space or chassis excursion, and does not constrict any natural air venting or circulation.

Dedicated harness anchor points can be accommodated within the internal CV2 chassis and the ERack body to facilitate customers requirements, together with grounding termination points and earthing thumb screws for operator connectivity.

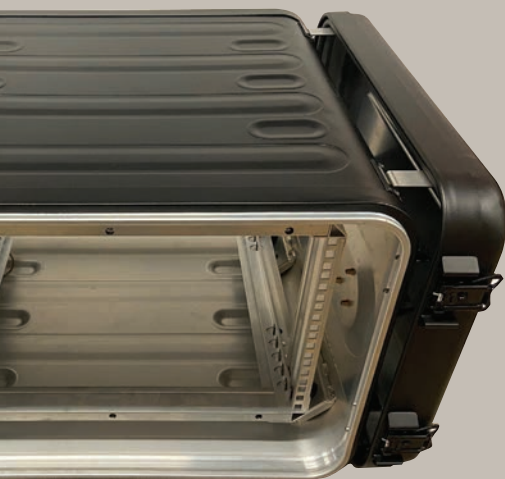

Convenient **lid stowage** each side of the rack body

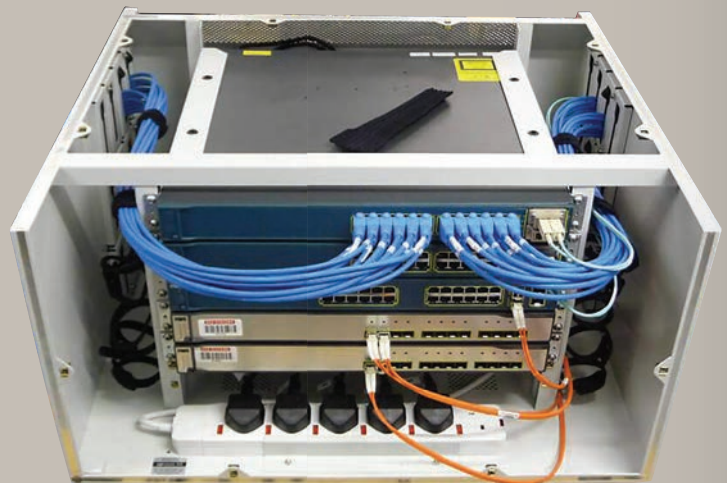

Complex **cabling and harness management** can be designed in to suit customers' specifications

Stacking multiple enclosures

Many applications require ERack enclosures to be stacked during both operation and transport scenarios.

Whilst observing the limitations of current health and safety, we recognise that ERack enclosures have to operate in confined and limited space conditions. This usually calls for them to be securely stacked on top of one another, without the risk of dislodging or becoming unstable.

Various ERack options are available to accommodate this requirement, including secure positive male/female stacking feet, mechanically interlocked stacked enclosures and/or webbing strap banding to secure the ERack stack to a floor or pallet.

With exceptionally heavy payloads, and when there could be 2 or more in a stack, the bottom ERack enclosure could be supporting hundreds of kilogrammes of compressive load. To ensure stability of the stack, and that the lower enclosure does not deform, additional stiffening sections can be added to the internal of the enclosure body to maintain mechanical integrity.



Shock and anti-vibration mount options

ERack can accommodate a payload of up to 50kg in its standard configuration. However, heavier payloads may be accommodated by double elastomeric or stainless-steel wire rope mounts. For example we offer 16 elastomeric AVMs – a variation on our standard 8 x AVM mount configuration – with options on elastomeric mount hardness from 45 shore to 70 shore. Wire rope mounts offer lifetime support, with many options available to accommodate various payload weights, shock and drop criteria and can be used in corrosive and hazardous atmospheres.

Fast-track delivery

We are able to meet promised short lead times of 6 week* delivery dates as the product is fully manufactured in-house.

*Subject to a final design sign off



Large moulded rubber **stacking feet** ensure positive location



A **palletised order** is ready for wrapping prior to delivery

Easily Customised – from Start to Finish

1

Initial client enquiry, through ensuring we fully understand the technical brief, the product performance and compliance requirements. Compiling a formal quotation, including specification, accreditation and reference engineering drawings – providing pricing and manufacturing lead times, and answering any subsequent questions.

2

Acknowledging receipt of the PO, confirming delivery date and destination details, and completing the product design and client sign off.

3

Generating full engineering drawings, compiling a full BOM and scheduling manufacturing and delivery information into our ERP system before issuing the manufacturing bundle of information to the production floor.

7

Extruding the hollow section male/female mating sections, and forming the 55mm radii (prior to age hardening) on hydraulic CNC forming machines, maintaining tight dimensional tolerances and planar flatness.

8

Jig cutting the formed hoops to size before fixture welding and fettling to form complete rings to dimensional and planar tolerances.

9

EMC specified ERack products, all ERack 3 body and lids are iridited / surface treated to enhance conductivity. Impregnated gaskets and metal-to-metal design ensure EMC compliance.

13

Close visual inspection is carried out after the painting process, including colour match, paint texture uniformity and masking detail.

14

Building the CV2 chassis from CNC machined components, secured with stainless steel rivnuts and carefully inspected for any residual FOD.

15

ERack final assembly to fully detailed drawings and build instructions – with step by step sign off.

One of ERack's main strengths is that it is cost-effective and rapidly customisable. The process chart below demonstrates the steps that are taken to make an ERack. Each enquiry is individually assessed and the ERack enclosure is customised to precisely meet the application requirements.

4

Purchasing any special (non-stock) components, commence kit mustering all parts and scheduling material, skills and machinery to meet the promised despatch date.

5

The ERack body manufactured from hi-tensile sheet aluminium, determining best material yield, laser cutting to size including all holes and other features, press forming the stiffening ribs, handle recesses and stacking feet and forming the 55mm edge radii using 'soft' urethane tooling. Seam welding the 2-part body (bottom deck to the upper body), stitch welding the 8 x AVM brackets using the ERack welding fixture which determines accurate positioning and combines cooling plates to eliminate distortion.

6

The ERack lids are deep drawn using press form tooling with removable inserts, on a 200-ton power press, trimming the lid edges on a 5-axis laser, and laser cutting rotary latch spindle and any connector holes as required. For non standard depth lids (exceeding 70mm) a full perimeter skirt is seam welded to create deeper lids.

10

Male/female formed and welded rings are then bonded to the body and lids using high performance, two-part acrylic adhesive that offers excellent shear, peel, and impact performance within temperature ranges from -40°C to +70°C.

11

Body and lids are then de-greased and etch primed before electrostatically applying a wear resistant polyester powder coating. A variety of RAL colours are readily available.

12

Other surface painting options are available including CARC, IRR (Infrared reflective) wet painting and alternative surface textures.

16

Visual, dimensional and physical review prior to final inspection sign off.

17

Craft paper wrapping is used for the initial wrap to protect the paint finish – prior to specific further packing instructions.

18

Packing for local delivery or palletising for National and Export delivery – every ERack enclosure is carefully and securely final packed. For long distance and export shipments, palletised products are covered with plywood sheets to prevent accidental knocks during transit and then clingfilm wrapped on our automatic pallet wrapping machine.

Key New Features

Moulded rubber stacking buffer – gives ability to positively stack with different depth ERack racks – and to stack with competitive racks

Stiffening ribs on top and bottom decks with outdented feet accommodate static stacking

CNC machined high tensile extruded CV2 chassis

Double hollow section CNC formed male / female extrusions – permanently bonded to lids and bodies and incorporating a climate gasket seal.

Press tooled one piece lid – no welds / no leak points with removable inserts to accommodate connector panels and / or recessed rotary latches

Central indent – to rigidise the flat lid front and offers options for connectors or debossed client branding

Customised connector panel and mounting ring (IP65 & EMC compliant) CARC painted with silk screen connector identification

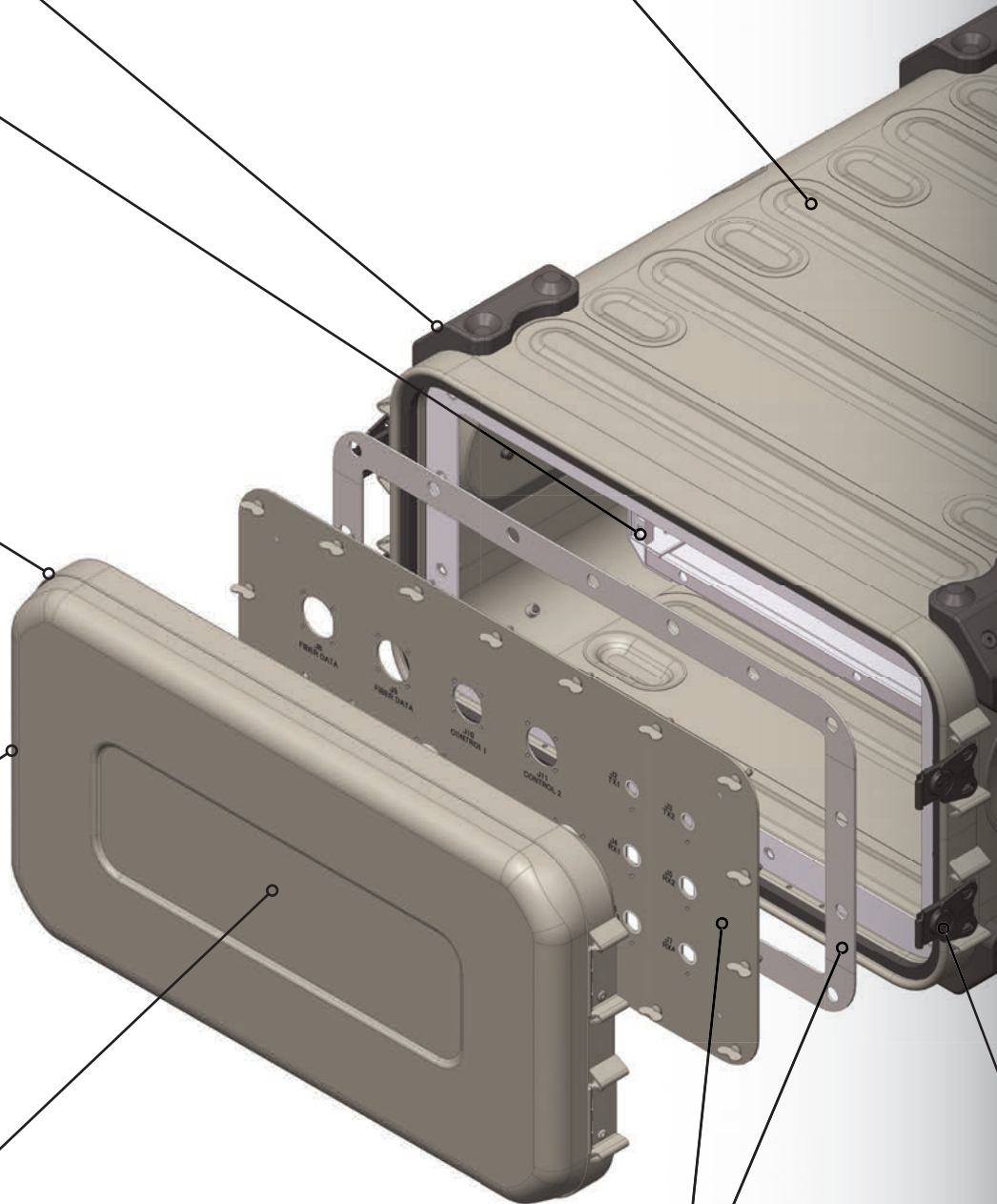

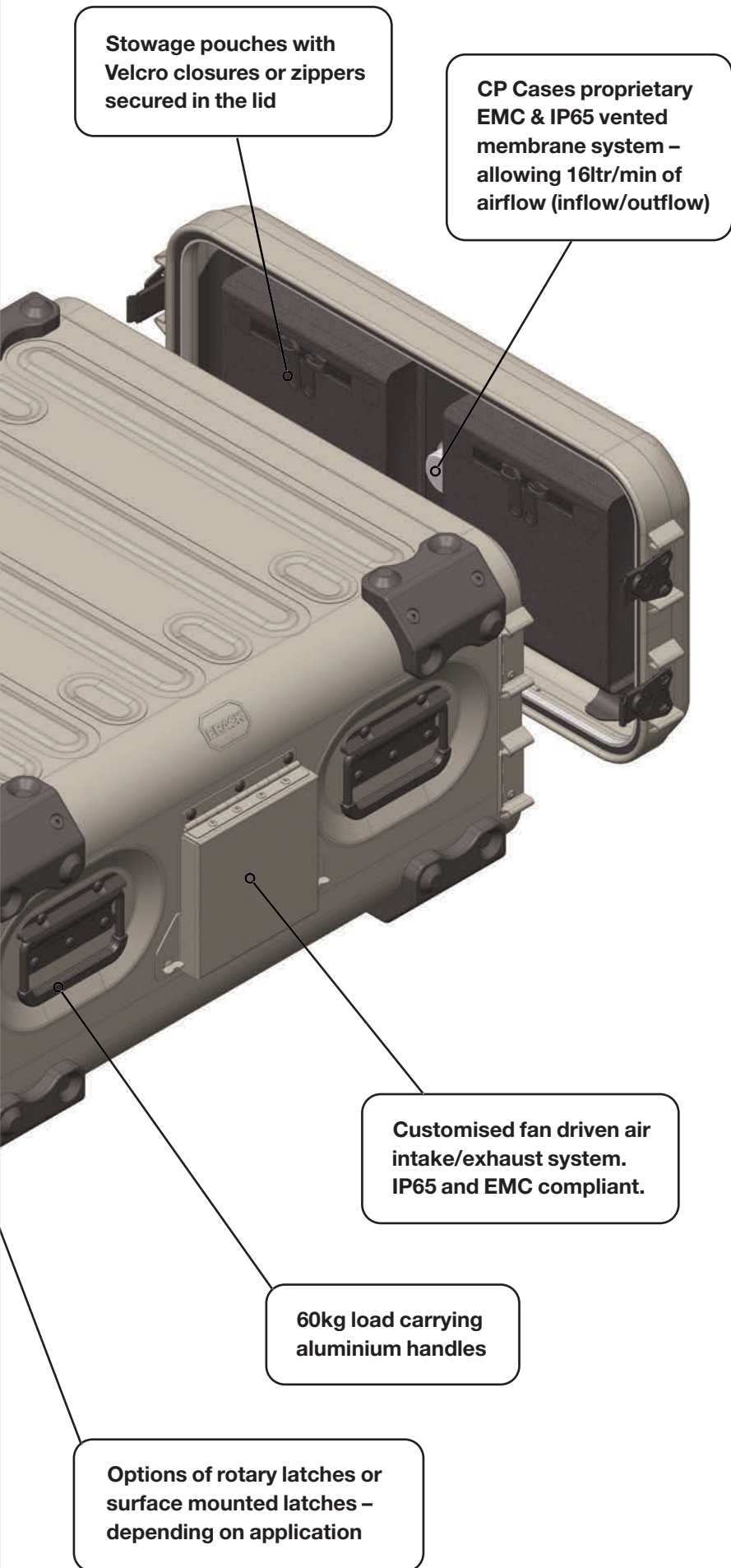

Stowage pouches with Velcro closures or zippers secured in the lid

CP Cases proprietary EMC & IP65 vented membrane system – allowing 16ltr/min of airflow (inflow/outflow)

Customised fan driven air intake/exhaust system. IP65 and EMC compliant.

60kg load carrying aluminium handles

Options of rotary latches or surface mounted latches – depending on application

ERack

As with all CP Cases' products, ERack is fully customisable to suit individual client requirements; CP Cases has extensive experience in designing and manufacturing ruggedised OEM cases and containers, and are able to provide practical solutions for unique applications, when a case or an extremely tough container is required for deployment, transport or storage.

ERack carries the following accreditations and standards:

MIL-STD-810G
 DEF STAN 00-35
 Ingress Protection rating IP65
 RoHS compliant
 NATO stock numbers (on request)
 CV2 chassis conforms to IEC 60297-3,
 DIN 41494 and EIA 310

- AI Aluminium** Rugged, 1.5mm high tensile aluminium alloy construction
- I Chassis Depth** Standard chassis depths: 350mm, 480mm, 610mm, 740mm and 870mm
- U Sizing** Available from 2U to 18U sizes
- HR Half Rack** designs also available
- Lightweight** The 6U 480mm deep version weighs less than 14.7kg including lids
- Pat. Patented** Unique patented design
- Secure Closure** Quick release latches (surface mounted or recessed rotary type) ensure mating lid/body give water and dust tight seal
- Lids** Precision manufactured and interchangeable
- Stackable** with inter-locating ribs on container top and bottom surfaces
- Temperature** Stable in temperatures from -40°C to +70°C
- Fast-track delivery** available

Venting, Vacuum, Pressure and Humidity

Always a consideration in sealed containers is the requirement to equalise any pressure differences between the inside and ambient outside of the enclosure. Whether it's natural venting, breathing membranes, special pressure relief valves (PRVs) or manual activated systems – the issue has to be addressed.

Maintaining an hermetically sealed enclosure with an air and water tight seal, when there is a difference in temperature (and therefore pressure) between the enclosure internal and the ambient external poses significant issues.

Allowing differential pressures to build causes the internal air to become either positively pressurised or conversely, to become a negative partial vacuum. This difference in pressure (Delta) most often comes about through transporting the enclosure – where either local climate temperature changes, and/or altitude changes bringing variances in external ambient. In either event, the pressure difference must be managed to maintain the enclosure seal and integrity.

This is accomplished by utilising either specialised open venting systems or regulated pressure relief valves with pre-determined open/close parameters. The selected device is incorporated into the enclosure design to ensure the dust and watertight seal, whilst allowing the enclosure to 'breathe'. Aggressive changes in pressure, such as rapid altitude ascent or decent, is managed by establishing the volume of the enclosure, calculating the rate of air transmission required to maintain the seal, and siting the appropriate valve(s) in the required positions.

Managing this becomes even more of a challenge when the enclosure is EMC shielded – where venting has to also incorporate an EMC screen to prevent the emission or intrusion of electromagnetic interference. This is accomplished by adopting the Faraday Cage principles of introducing a mesh or metallic gauze within the venting or pressure relief system.

Managing humidity in an hermetically sealed enclosure requires understanding the moisture content at any given time. This can be accomplished by incorporating a Humidity Indicator into the build specification, pre-set and colour coded to various Rh levels. When it is apparent that the humidity levels exceed permitted levels, then 'drying out' the enclosure can be achieved by the introduction of a desiccant cartridge. CP Cases offers various designs of these – some being replaceable from the outside of the enclosure – especially useful when the enclosure / container is being used for long term storage.

If the enclosure is climate controlled with a COOL A/C unit – then attention is given to prevent the potential accumulation of condensate.



IP65 breather valve incorporating membrane vent allowing in / out air movement. Available in light grey (RAL-7035) as standard – other colours on request



Automatic **pressure relief valve** (PRV) with options on 'crack pressure'



Humidity indicator showing various RH levels

Fan mounting plate EMC gasket

Hinged stay

Tray

Fan mounting plate with thumb screws

Fan cover gasket neoprene sponge

Fan cover

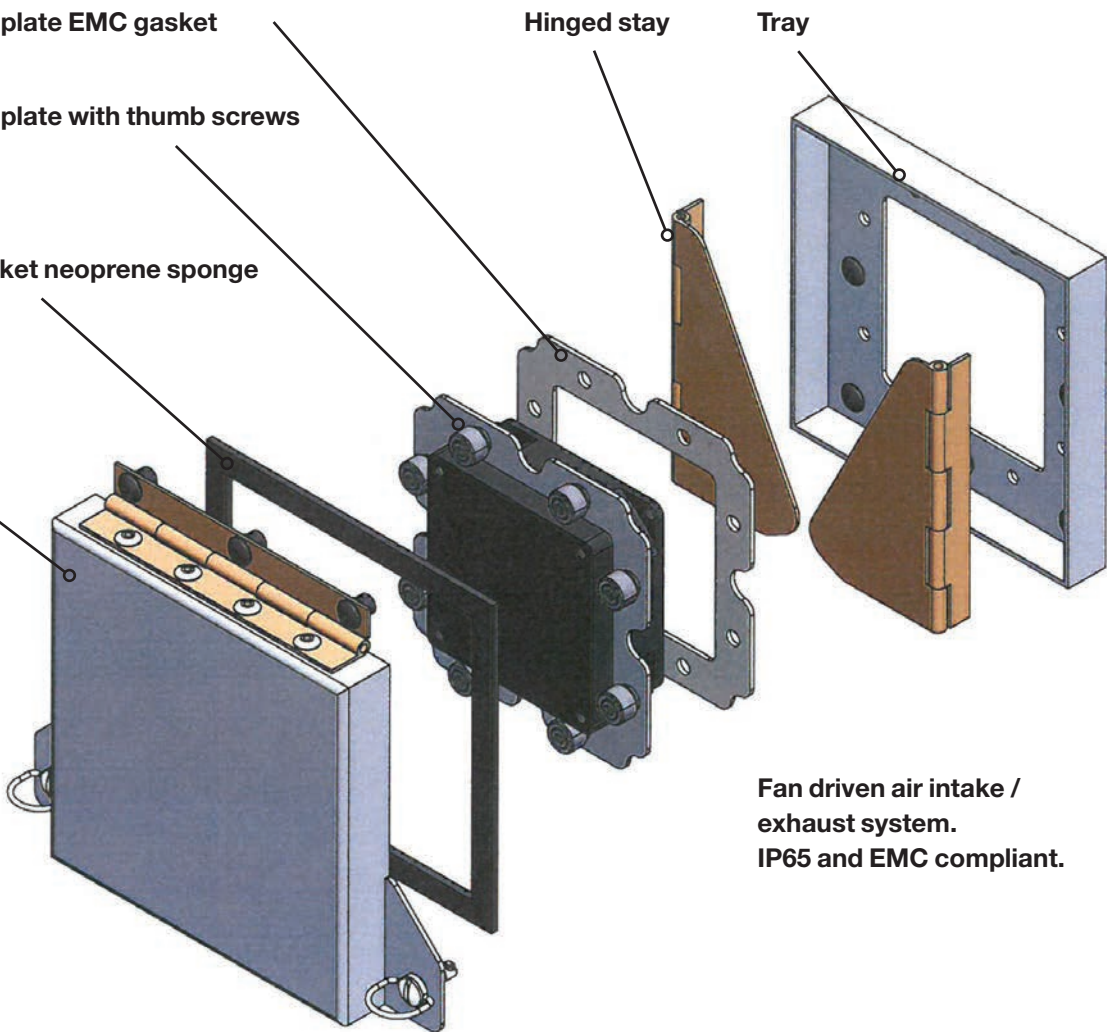

Fan driven air intake / exhaust system. IP65 and EMC compliant.



Internal axial fan to give forced air cooling. IP55 rated fans available on request.

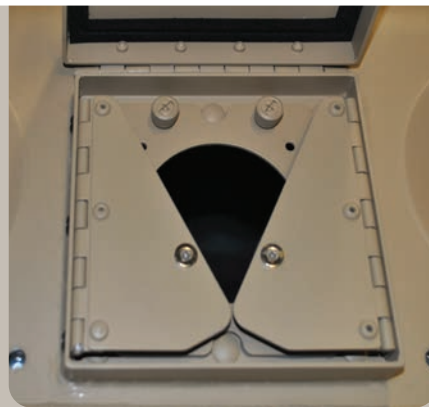

Above Hinged flap stays in closed position

Right Fan cover with stays open at 29 degrees, the optimum angle to prevent rain ingress.

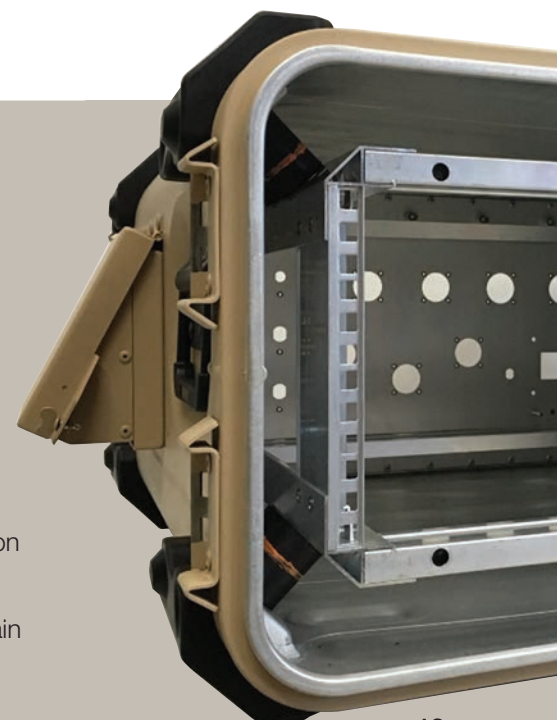

Hinged doors...

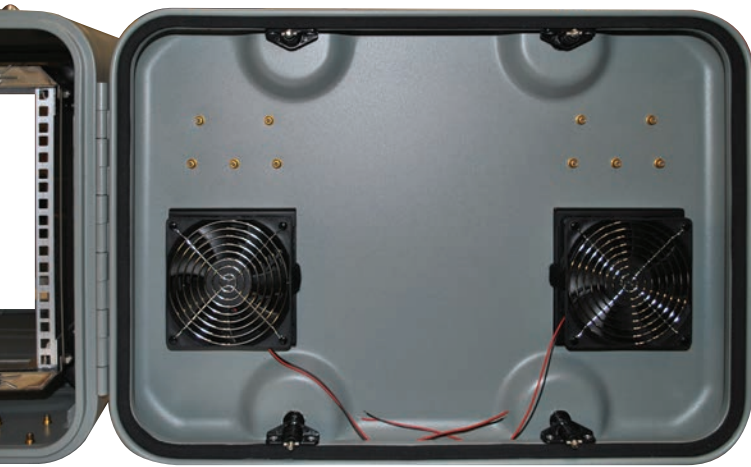

Aluminium / Stainless Steel **piano hinges** to maintain a climate seal

or Removable Lids



Lid handles can be included where restricted access passageways and in-vehicle applications demand

Latch options

Rotary latch

- **Surface mounted**, side activated latches
- **New design rotary latch** lever offers better grip with gloved hands
- **Simple 'push and turn'** effects easy closure every time
- **Rotary latch** will not open under extreme vibration, drop or shock
- **Stainless steel spindle and interlocking nylon tapered guides** ensure lid and body align and mate every time
- **Twin hollow sections of male and female extrusions** offers resistance against torsional twisting and provides beam strength

Butterfly latch

Surface mounted, side activated **butterfly latch**, cam operated completed with glide-buffer.



Bonding

ERack employs high performance, two-part acrylic adhesive that offer excellent shear, peel, and impact performance. These tough adhesive products provide improved adhesion to plastics and metals, and feature a fast cure rate; providing structural strength in minutes. These bonding techniques are used in other high performance engineering applications such as aerospace, automotive and Formula 1. Tested for surface flammability, smoke, toxic gas generation, and caloric content. Conforms to ASTM E162, ASTM E662, ASTM E1354, Bombardier SMP 800-C, and Boeing BSS 7239 test methods. DP8405NS.

CNC formed extrusions bonded (shown in green below) to rack body / lids incorporating skinned silicon sponge gasket (shown in red below) giving a water and dust tight seal.

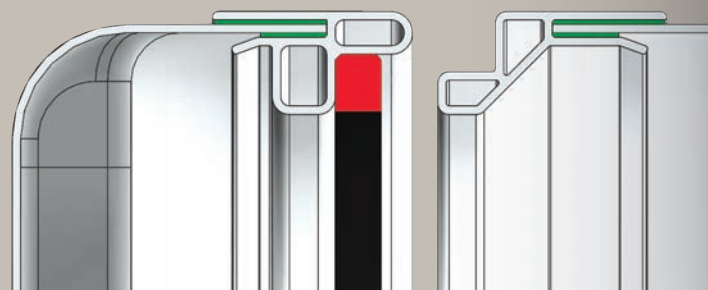

Security



There are several solutions to securing ERack lids against tamper and intrusion during transit and storage. Above, **double eye** to accommodate padlock.

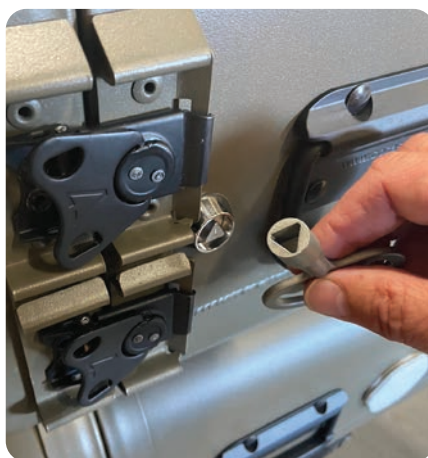

Tamper proof key lock to prevent the casual intruder

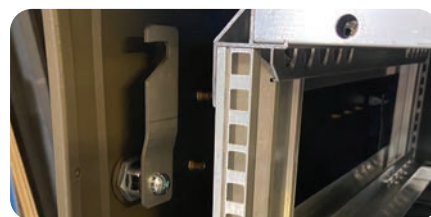

Key operated lock latch in open and closed positions

Wheelboards



Standard

Two types of ERack **wheelboards** are available, both allowing heavy loads and stacked enclosures to be easily manoeuvred. Supported by 4 x 100mm diameter swivel castors (2 of which incorporate swivel and wheel brakes) with elastomeric solid tyres, the stacked enclosures are mechanically fastened to the wheelboard to prevent any slippage. Loads up to 300kg can be accommodated.



Heavy Duty

Enclosures that are configured with COOL A/C refrigerated systems can also be transported on **larger wheelboards**, with the option of fork lift slots.



Low Profile

The ERack **low profile wheelboard** can be mechanically attached to the ERack body to provide a semi permanent base.

Connector panels

Customising your connector panel requirements is a standard feature for us. Whether the panel is in the ERack lid(s) or body, whether they are fixed or removable, whether they require EMI shielding, and/or climatic seals – we ensure we work with your engineers and provide exactly what the application demands. Using CNC laser to cut connector holes, any connector aperture can be accommodated with accuracy.

We can provide a variety of fixings options for removable panels, including captive threaded fasteners and quick release quarter fasteners. Panels can be painted to your specification with connector apertures fully masked to ensure EMI connectivity and connector legends can also be silk screened onto the painted panel.

Removable panels allow easy access to the interior of racks by means of quarter turns latches.

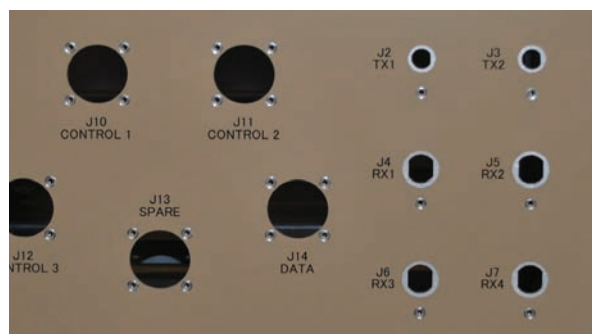

Fully customised **connector panels** manufactured to client specification – including connector cut outs, earth studs, iriditing, painting (all specs) and silk screen printing.



Tie downs / lifting rings

Stainless steel triangular bale allows for centralised lashing to truck flat beds, ship decks and exposed outdoor applications. The sprung 8mm SS bale can move through 180 degrees to act as lifting points.



Black powder-coated stainless steel tie-down and lifting ring for when a freight solution is required.



Welding

Custom-made **welding fixtures** are used to ensure all rack components are welded to predetermined dimensions and tolerance. Our codified skilled welders use Pulsed Synergic TIG welding technology in the manufacture of ERack.

Welds are systematically inspected, and tested for quality.



EMC / EMI Shielding



Panel ring with EMC oriented wires gasket in silicone

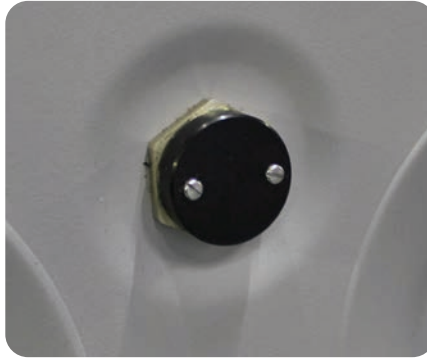

EMC compliant **PRV**

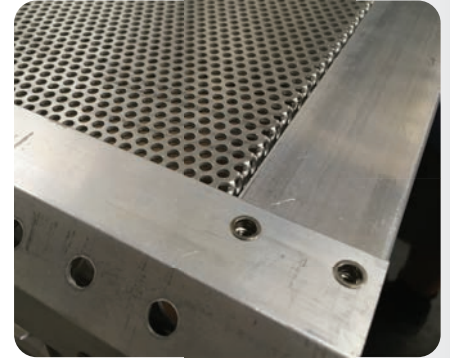

Perforated **SS cage** around the 19" chassis

With the growing requirement for secure communications and protection from cyber-attack, electromagnetic screening is more often required. EMI compliant ERack enclosures incorporate a variety of specialised impregnated and conductive gaskets to ensure connectivity between the lids and the enclosure body.

Specialist conductive gaskets, use of wire mesh braid, embedded wire and Faraday cage features are incorporated into the ERack designs to offer customers various levels of EMC solutions.

EMI screening is also considered for all possible electromagnetic leak paths – which could include connector panels (especially removable ones), venting and pressure equalisation devices and humidity indicators.

Achieving the right solution for every individual application is accomplished by a deep understanding between our engineers and your project management team, to overcome any potential technical challenges.

Another option (subject to design parameters) is to secure perforated aluminium sheets around the CV2 chassis, providing a Faraday Cage to inhibit ingress or egress of EM interference.

CP Cases enjoys a long relationship with a third party accredited test facility, and are able assist customers in determining EMI performance levels for ERack enclosures and associated equipment.

Pressing



Press forming the high-tensile aluminium sheets using a 200 ton power press, followed by trimming using a 5-axis laser cutter

Insulation



Closed cell foam interiors provide thermal and / or acoustic insulation.

Branding



Client branding, corporate logos, barcoding, warning signage, instruction and ident labelling are all part of our unique turnkey service. We have the experience, skills and equipment in-house, including label printers, screen printing equipment, thermal impression printing and press tool debossing.

Climate control – sunshade mounts

Ambient temperatures in extreme climates need to be carefully managed to maintain the desired optimal working temperature inside the ERack enclosure – especially when COTS equipment is being used.

Outside air venting only works in temperate climates but when temperatures fall well below zero, or reach tropical levels,

then equipment usually requires climate control to continue working effectively.

Whether it be simple thermal insulation, shaded protection from direct solar loads, forced air cooling with thermostatically controlled fans, incorporating refrigerated cold air or providing pre-heating – all are part of the technical service that we offer.



Compressor based A/C with removable **sunshade** configuration including 125mm deep lids

Cool collar

CP Cases COOL™ Portable Air Conditioning units deliver air conditioning and climate control for use in 19" racks and can be applied either as a COOL-COLLAR™ or as an integrated unit, providing a one-stop-shop for rack mount cases to maintain equipment's optimal operating conditions.

All combinations of A/C and ERack enclosures are designed to meet NEMA 4 and NEMA 4X standards for indoor and outdoor applications.



Size List

Part Number	Height	Depth	Width	U-Height	Chassis Depth	Volume	Weight*	Handles	Catches
	External mm			U	mm	m ³	kg	No.	No.
RRV3 0248-0707	235	710	594	2	480	0.10	12.4	4	8
RRV3 0261-0707	235	840	594	2	610	0.12	13.5	4	8
RRV3 0274-0707	235	970	594	2	740	0.14	14.6	4	8
RRV3 0287-0707	235	1100	594	2	870	0.15	15.8	4	8
RRV3 0348-0707	280	710	594	3	480	0.12	13.1	4	8
RRV3 0361-0707	280	840	594	3	610	0.14	14.3	4	8
RRV3 0374-0707	280	970	594	3	740	0.16	15.5	4	8
RRV3 0387-0707	280	1100	594	3	870	0.18	16.7	4	8
RRV3 0448-0707	324	710	594	4	480	0.14	13.9	4	8
RRV3 0461-0707	324	840	594	4	610	0.16	15.1	4	8
RRV3 0474-0707	324	970	594	4	740	0.19	16.4	4	8
RRV3 0487-0707	324	1100	594	4	870	0.21	17.6	4	8
RRV3 0548-0707	375	710	594	5	480	0.16	14.7	4	8
RRV3 0561-0707	369	840	594	5	610	0.18	15.9	4	8
RRV3 0574-0707	369	970	594	5	740	0.21	17.2	4	8
RRV3 0587-0707	369	1100	594	5	870	0.24	18.5	4	8
RRV3 0648-0707	413	710	594	6	480	0.17	15.4	4	8
RRV3 0661-0707	413	840	594	6	610	0.21	16.8	4	8
RRV3 0674-0707	413	970	594	6	740	0.24	18.1	4	8
RRV3 0687-0707	413	1100	594	6	870	0.27	19.4	4	8
RRV3 0748-0707	457	710	594	7	480	0.19	16.2	4	8
RRV3 0761-0707	457	840	594	7	610	0.23	17.6	4	8
RRV3 0774-0707	457	970	594	7	740	0.26	18.9	4	8
RRV3 0787-0707	457	1100	594	7	870	0.30	20.3	4	8
RRV3 0848-0707	502	710	594	8	480	0.21	17.3	4	12
RRV3 0861-0707	502	840	594	8	610	0.25	18.7	4	12
RRV3 0874-0707	502	970	594	8	740	0.29	20.1	4	12
RRV3 0887-0707	502	1100	594	8	870	0.33	21.5	4	12
RRV3 0948-0707	546	710	594	9	480	0.23	18.1	4	12
RRV3 0961-0707	546	840	594	9	610	0.27	19.5	4	12
RRV3 0974-0707	546	970	594	9	740	0.31	21.0	4	12
RRV3 0987-0707	546	1100	594	9	870	0.36	22.4	4	12
RRV3 1048-0707	591	710	594	10	480	0.25	18.8	4	12
RRV3 1061-0707	591	840	594	10	610	0.29	20.3	4	12
RRV3 1074-0707	591	970	594	10	740	0.34	21.8	4	12
RRV3 1087-0707	591	1100	594	10	870	0.39	23.3	4	12
RRV3 1148-0707	635	710	594	11	480	0.27	19.6	4	12
RRV3 1161-0707	635	840	594	11	610	0.32	21.1	4	12
RRV3 1174-0707	635	970	594	11	740	0.37	22.7	4	12
RRV3 1187-0707	635	1100	594	11	870	0.42	24.2	4	12
RRV3 1248-0707	680	710	594	12	480	0.29	20.9	8	12
RRV3 1261-0707	680	840	594	12	610	0.34	22.5	8	12
RRV3 1274-0707	680	970	594	12	740	0.39	24.1	8	12
RRV3 1287-0707	680	1100	594	12	870	0.44	25.7	8	12
RRV3 1448-0707	769	710	594	14	480	0.32	22.4	8	12
RRV3 1461-0707	769	840	594	14	610	0.38	24.1	8	12
RRV3 1474-0707	769	970	594	14	740	0.44	25.8	8	12
RRV3 1487-0707	769	1100	594	14	870	0.50	27.5	8	12
RRV3 1548-0707	813	710	594	15	480	0.34	23.2	8	12
RRV3 1561-0707	813	840	594	15	610	0.41	24.9	8	12
RRV3 1574-0707	813	970	594	15	740	0.47	26.6	8	12
RRV3 1587-0707	813	1100	594	15	870	0.53	28.4	8	12
RRV3 1648-0707	858	710	594	16	480	0.36	23.9	8	12
RRV3 1661-0707	858	840	594	16	610	0.43	25.7	8	12
RRV3 1674-0707	858	970	594	16	740	0.49	27.5	8	12
RRV3 1687-0707	858	1100	594	16	870	0.56	29.3	8	12
RRV3 1848-0707	946	710	594	18	480	0.40	25.4	8	12
RRV3 1861-0707	946	840	594	18	610	0.47	27.3	8	12
RRV3 1874-0707	946	970	594	18	740	0.55	29.2	8	12
RRV3 1887-0707	946	1100	594	18	870	0.62	31.1	8	12

Sizes and Numbering System



Product numbering convention for (typically) 6U x 610 chassis depth with 2 x 70mm lids RRV3 0661-0707

RRV3	06	61	—	07	07
ERack3	U-height	Chassis Depth (cm)		Lid depth Front (cm)	Lid depth Rear (cm)

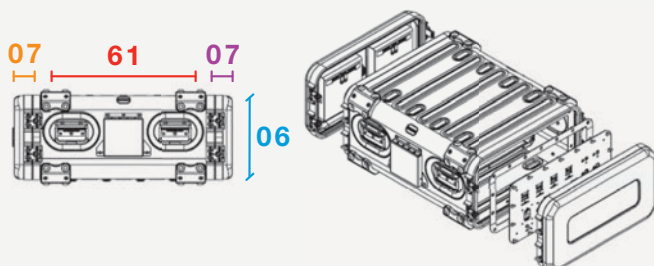

RRV3-1674-0712

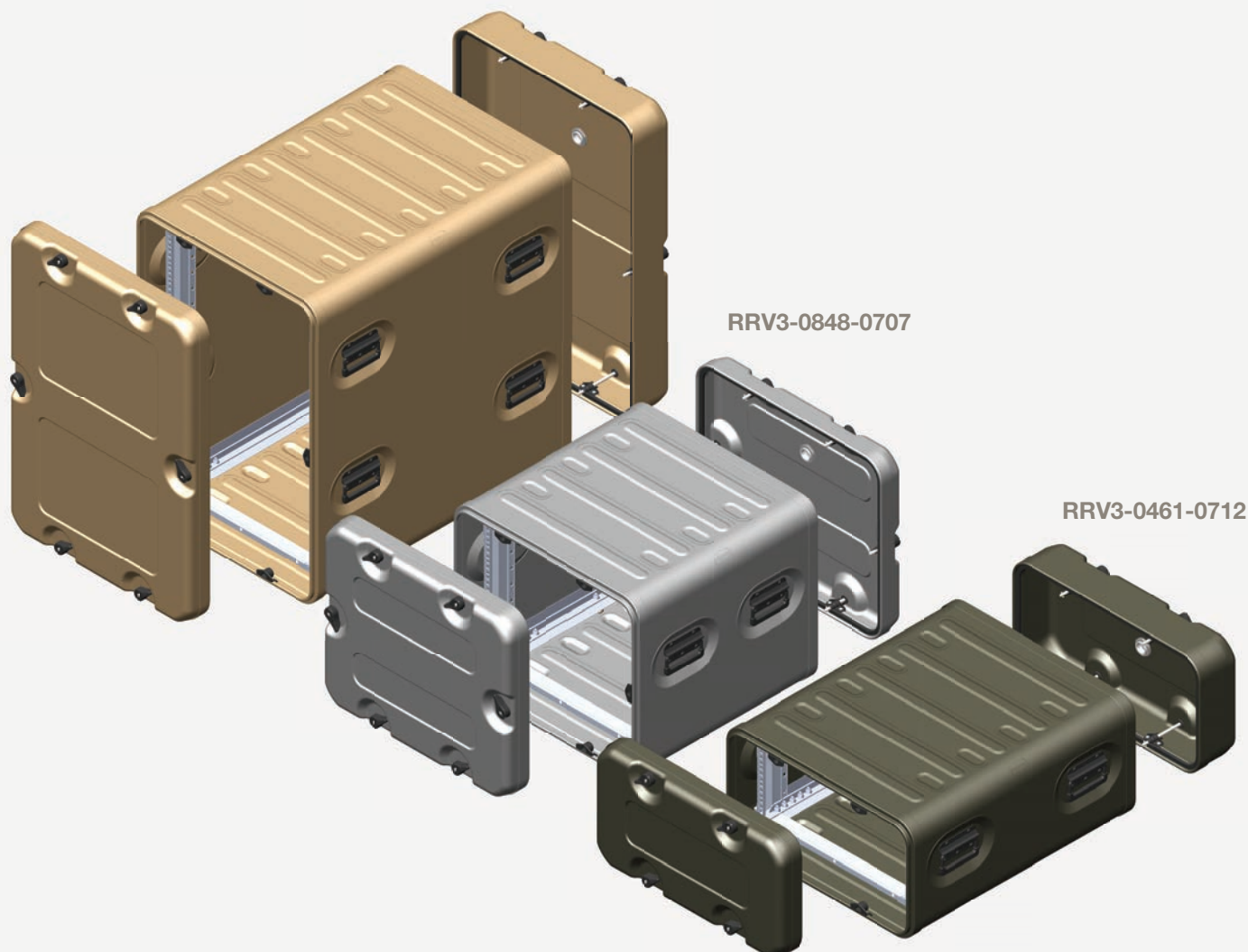

RRV3-0848-0707

RRV3-0461-0712

ERack Accessories

EasyGlide™

The **EZ3 EasyGlide system** allows quick and efficient removal of the internal 19" shock mounted chassis – often required for ‘in the field’ maintenance and to enable bench access when populating and wiring the equipment at the initial build stages.

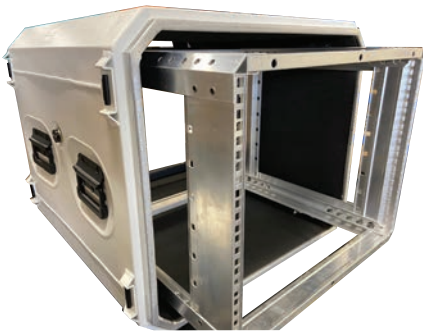

The EZG3 system comprises 4 x PTFE (polytetrafluoroethylene) coated glide channels, which mate with the chassis and allow almost frictionless movement between the two. The chassis is fitted with 4 x SS conical locator pins which ‘dock’ into the rear cross members of the EZG3 – providing accurate and secure location. The SS cones are locked into position by 4 x SS easily removable R Clips (no tools required) and are designed to withstand vibration, shock and drop.

Removable Chassis System

Removable ‘EasyGlide’ chassis frame option allows the complete withdrawal of the 19" inner frame in constricted spaces or semi-permanent installations, without loss of anti-vibration characteristics.

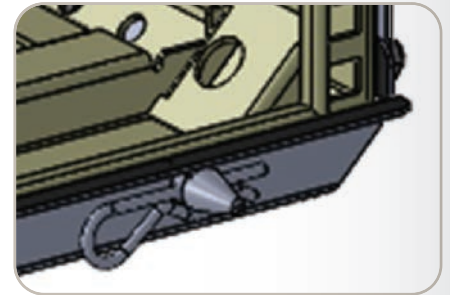

Stainless steel EZG3 system secures CV2 chassis with 4 x SS **cones** and SS removable ‘R’ **clips** – no tools required

Cable / Accessory Storage Pouches



2 x small **cable pouches** – either side of breathable vent

Designed and manufactured in our in-house textiles department, we offer a wide variety of **internal pocket lid pouches**. Special designs incorporate zip or Velcro closures, silk screen branding and can include transparent

windows and net pocketing. A zipped pouch can be secured in place in both shallow and deep rack lids for the storage of cabling and leads. Cable pouches can be retrofitted by users without the use of tools.



A4 document holder with see-through window



Zipped storage pouch with transparent window

ERack Jackets

For protection against abrasion, scratches and scuffing through rough handling, **ERack protective jackets** are available. Made from a three part sandwich of texturised nylon and closed cell polyethylene foam; they are extremely hard wearing with a non-rip finish and allow easy access to handles and tie downs. Jackets can be silk screen or embroidery branded with the client’s name and logo.



Protective Skirts

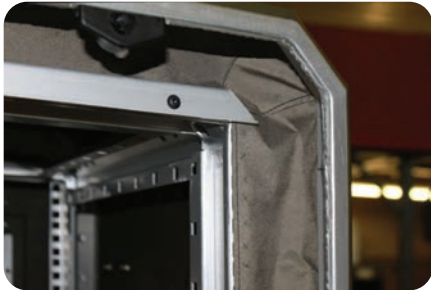

For protection against the ingress of rain under operational conditions where the lid(s) need to be removed, **flexible skirts** can be fitted between the outer enclosure body and the internal chassis. The weather resistant skirt(s) allow full excursion of the chassis during transit conditions, and are commonly used in A/C configured systems when it is important to maintain controlled temperature conditions inside the enclosure. When skirts are used, equipment front panels need to also be sealed to prevent the ingress of water or the escape of cold air.

High performance textile skirts are also available to maintain the EMC integrity of the rack, which feature nickel coated metalized fibres woven into the fabric.

Handles



E-Rack enclosures are fitted (as standard) with 4 x **sprung handles**. These handles are black powder coated and recessed into the side walls of the enclosure. The standard handles are rated at 60kg each and the bale width is wide enough to allow handling with arctic gloves.

A black powder coated **SS handle** is also available with an 8mm diameter SS bale with a rubber grip.

Earthing



Earthing wire braid to ground chassis to E-Rack body with thumb screw to facilitate quick release EZ Glide chassis removal.

Panel Fixings

M6 Stainless Steel Cage Nut, Pack(s) of 16 panel screws and cup washers included per 4U.



Insect Hoods

Removable close knit mesh net to protect equipment while still allowing visual access to the rack.



Support Shelf

Stainless steel full-width shelf to provide extra support for heavy payloads.



Other CP Products

Climate Control

CP Cases Climate Control offers air conditioning and climate control units for use in CP Cases' ERack.

Delivered either as a COOL-COLLAR™ or as an integrated unit, COOL PORTABLE A/C provides 19" rack mount cases with air conditioning systems to maintain equipment's optimal operating conditions. Available in thermoelectric and compressor based A/C variants, both with additional heating options and digital temperature control incorporated.

All CP Cases Climate Control units can be fitted with accessories including stowage pouches, wheel kits, pressure relief valves and humidity indicators.

COOL-COLLAR™

COOL-COLLAR™ is a removable A/C capability for 19" racks with an airtight and waterproof seal to allow the unit to function in extreme conditions. The unit is attached to an existing rack to maintain an optimum operation temperature for equipment.

Where a greater cooling requirement is needed, two COOL-COLLARs™ with AC units can be fitted to both the front and rear of the rack. Units are available up to 3500 watts of cooling.

Integrated Units

A/C can be built directly into the rack system. These climate control units provide cooling and heating, when required and automatically when temperature perimeters are met. Normally end-mounted, CP Cases offer the capability to integrate in a range of orientations to fit client requirements.



ERack Size Numbering System

Part Number*	Description	External mm			U	No.	No.	No.	kg
		H	W	D					
RRCC 0629-0707 TEU	COOL Collar 6U 2 x 70 mm lid	419	615	416	6	2	8	N	8.79 (E)
RRCC 0829-0707 TEU	COOL Collar 8U 2 x 70 mm lid	508	615	416	8	2	10	N	10.29 (E)
RRCC 0829-0707 VCC	COOL Collar 8U 2 x 70 mm lid	508	615	416	8	2	10	N	10.13 (E)
RRCC 1029-0707 TEU	COOL Collar 10U 2 x 70 mm lid	597	615	416	10	2	12	N	11.59 (E)
RRCC 1029-0707 VCC	COOL Collar 10U 2 x 70 mm lid	597	615	416	10	2	12	N	11.63 (E)
RRCC 1229-0707 TEU	COOL Collar 12U 2 x 70 mm lid	686	615	416	12	4	12	N	11.99 (E)
RRCC 1229-0707 VCC	COOL Collar 12U 2 x 70 mm lid	686	615	416	12	4	12	N	13.18 (E)

U-Height
Handles
Latches
Wheels
Weight

* TEU = Thermoelectric Unit
VCC = Vapour Compression Cycle
(E) = Estimated weight

Weight listed is for COOL-COLLAR only.
Please contact CP Cases for air conditioner weights.
(E) = Estimated weight

Foam Engineering



CNC routed foam housing part of a knee implant in sculptured high density closed cell foam.

Airship



Ultra lightweight **honeycomb sandwich construction** available in standard sizes or customised designs.

Customised Interiors



Rapid deployable Military **UAV fuselage** on a scissor jack platform – all inside an Amazon Container.

OB Camera Covers



Huge range of Outside Broadcast Camera **rain covers** – suitable for 'all weathers, any event'.

SatRack



One man portable lightweight **19" racks** and **half racks** available from 3U-8U and 5 chassis depths from 350mm-870mm.

Custom Rotomoulded Solutions



Design and manufacturing service providing cost effective **rotomoulding** solutions for small quantity specialist design requirements.



CP Cases Ltd

Unit 11 Worton Hall Industrial Estate | Worton Road | Isleworth | Middlesex | TW7 6ER | UK
Tel: +44 (0) 20 8568 1881 | Fax: +44 (0) 20 8568 1141
www.cpcases.com

**TRUSTED
WHEN IT
MATTERS**

About CP Cases

CP Cases designs and manufactures high-performance, protective cases and racks used for transport, operation and storage of essential equipment in commercial and military applications.

Many of our products are accredited to MIL-STD-810, rated IP65 and carry NATO stock numbers. With over 50 years' of expertise in producing cases, 19" rack solutions and rugged textile products, CP Cases has an unparalleled range of in-house skills and knowledge with materials and processes, including rotationally moulded products, plastic fabrication, aluminium, laminated plywood, HPP, textiles and CNC foam machining.

Full Capability Statement available on request.

