

SERIE

# SPIDER 13.80

SELF-PROPELLED AERIAL WORK PLATFORMS

Compact, Light and Easy to use

- Class leading stability when fully deployed.
- Super-compact stabilization foot print and zero tail-swing.
- The most stable drive when off-road.

## EASY MAINTENANCE

- Simple and friendly controls and on-board features.
- Light-weight for ease of transport



# PLA/TFORM

B A S K E T

# SERIE SPIDER 13.80

## BEST PERFORMANCES

### 1. Automatic and proportional side outreach

- This safety system automatically reduces the outreach by monitoring the stability and the cage overload.
- No jib restrictions with the max load in the basket.
- The system enables easy positioning of the basket in any working situation.



### 2. 360° rotation with no tail-swing

- The innovative design with telescopic boom and fly jib enables the free rotation without any protruding part.
- Cranked outriggers designed for increased ground clearance.



### 3. User friendly

- All designed to make the use simple.
- Wired remote control unit for drive.
- A multifunction manual operated control for stabilization.
- A 4 function remote control unit in the basket to operate the booms.
- All designed to operate the machine smoothly.



### 4. Uncomparable design and fabrication care.

- Process from steel to the product is carefully checked and followed.
- Fully protected by metal covers against falling objects.
- Easy access to maintenance compartments.
- Air/water and 230Vac outlets are available into the basket.



### 5. Standard with double drive speed.

- The model is particularly suitable for indoor use with electric power, therefore the double speed is essential to drive the model to the working site.
- Particularly useful when powered by batteries, enabling long drives with little power consumption.



### 6. Hydraulically extending under carriage

- On demand it is possible to order the machine with extending tracks to improve the drive stability.
- With this undercarriage and longer tracks the stability is guaranteed in any rough terrain.



### 7. Quick detach and interchangeable basket

- The designed allu basket enables a fast and easy removal.
- They're interchangeable basket for single or two persons.
- A single pin to remove and fit the basket plus a sensor to check the right installation is done by the operator.



### 8. The smallest tracked-lift offered in HYBRID version.

- In order to have a versatile machine different power solutions are available: The standard powered by engine and electric motor 230/110Vac mains. The electric one, powered by deep cycle batteries and electric motor 230/110Vac. The Hybrid one, the smallest spider powered by engine and batteries 24Vdc.



## OVERALL DIMENSIONS

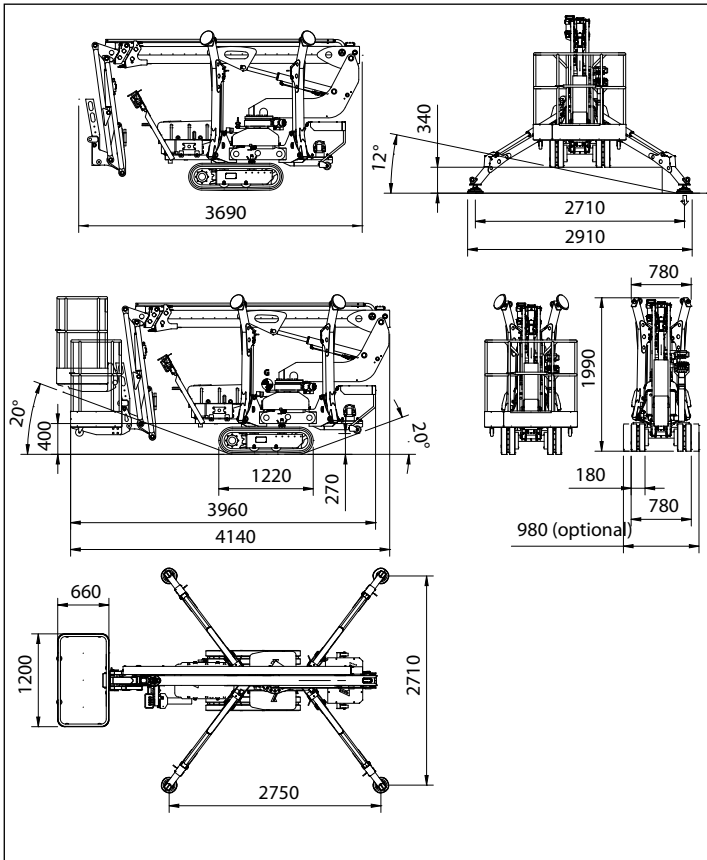

## WORKING ENVELOPE

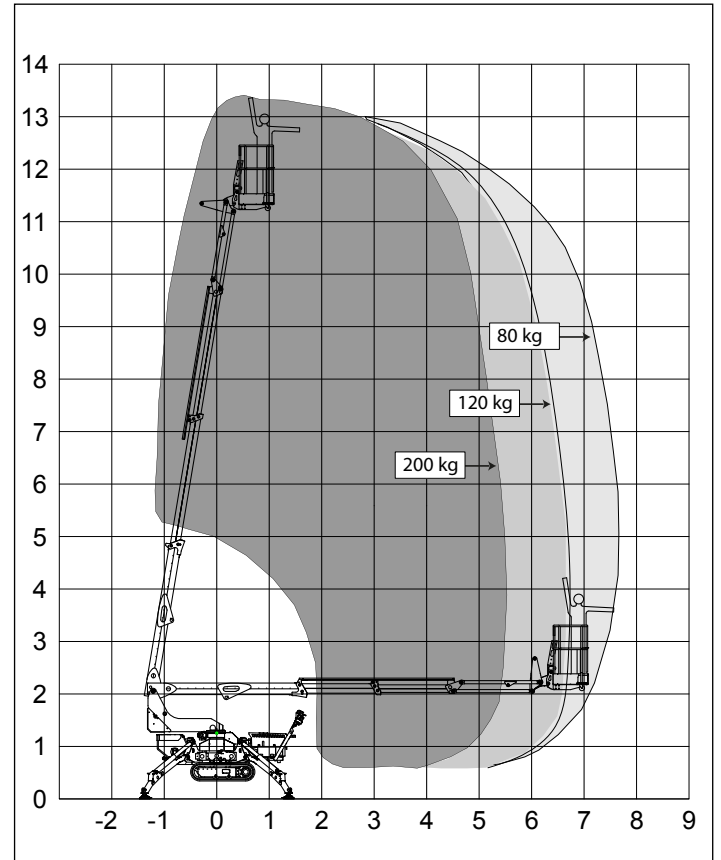

## EASY TRANSPORT

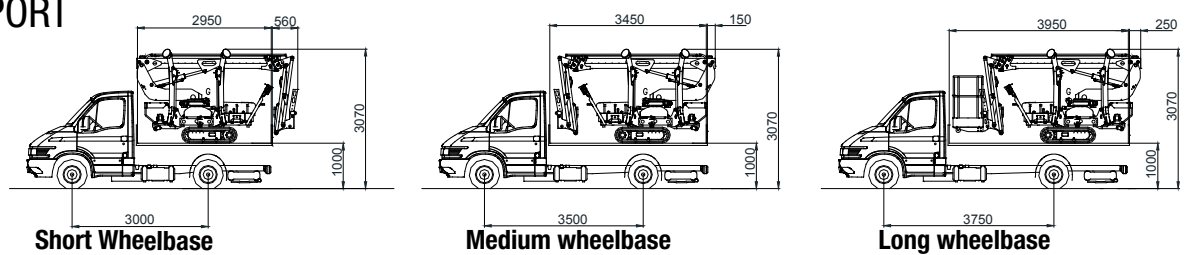







## OPERATIONS



# SERIE SPIDER 13.80

TECHNICAL DATA		VERSION		
		STD	E	ED
Max working height	m	13,40		
Max height basket floor	m	11,40		
Max side outreach	m	7,80		
Rotation angle	°	360		
Basket size (standard version)	m	1,20 x 0,70		
Basket rotation angle	°	ND		
Max basket capacity	Kg	200		
Lenght in stowed position (with detached basket)	m	4,20		
	m	3,55		
Min width in stowed position	m	0,78		
Min height in stowed position	m	1,98		
Stabilization footprint	m	2,80 X 2,80		
Max gradeability	deg. / %	16° (29%)		
Max side gradeability	deg. / %	12° (21%)		
Max drive speed	Km/h	3,50	1,70	3,50
WEIGHTS		STD	E	ED
Weight in working config.*	Kg	1500*	1500*	1650*
Ground pressure stowed machine (narrow tracking)	KN/m²	3,06		
Ground pressure when on stabilizers	KN/m²	2,26		
Max point load	KN	11,8		
POWER		STD	E	ED
Engine GX270 Honda (Petrol)	hp/rpm¹	8/3600	--	--
Engine 1B30 HATZ (diesel)	hp/rpm¹	7,2/3600	--	5,4 /3600
Electric motor 230 Vac	hp/KW	3 / 2,2	3 / 2,2	--
Electric motor 24 Vdc	hp/KW	--	5,5 / 4,0	5,5 / 4,0
Battery capacity 24Vdc Lead Acid	Ah	--	150	150
24Vdc Lithium-Ion	Ah	--	200	200
Battery charger (Lead/acid batt)	Ah	--	45	45
battery charger (Lithium/Ion)	Ah	--	100/50	100/50

\* Some weights may differ due to the chosen optionals

	+		<b>STD</b> - Combustion engine - Electric motor-pump single phase 230/110Vac
	+		<b>E - ELECTRIC</b> - Electric motor-pump 230/110Vac - Electric pump 24Vdc with deep cycle batteries
	+		<b>ED - HYBRID</b> - Combustion engine - Electric pump 24Vdc with deep cycle batteries

STANDARD EQUIPMENT	VERSION		
	STD	E	ED
Double telescopic boom with flying jib	•		
Combustion engine Honda petrol type	•	--	•
Smooth and multifunctions el.hydraulic controls	•		
Light allu basket and easy detachable	•		
Air/water and 230Vac outlets into the basket	•		
Stabilization with electronic levelling sensor (max 1,5°)	•		
Double drive speed hydraulic system (slow/fast)	•		
Wired remote control panel for drive	•		
All components are well protected against objects fall.	•		
Deep cycle batteries and electric-pump 24Vdc	--	•	•
Battery charger with double charging select. (10/23 Ah)	--	•	•
Single phase electric pump 230Vac/110Vac	•	•	--
Built-in fault messages diagnostic	•		
EXTRAS - ON DEMAND	STD	E	ED
Non marking rubber tracks particularly suitable for delicate floors.	•		
Honda iGX390 instead of Honda GX270 engine	•	--	•
Hatz Diesel instead of Honda GX270 engine	•	--	•
Lithium-Ion battery pack for longer working cycle	--	•	•
Oversized foot plates for soft ground.(diam.330mm)	•		
Oversized square 40x40cm nylon plates supplied with on-board housing frame.	•		
Single man basket	•		
Electric power pack for emergency descent (12Vdc).	•	•	--
Basket working light	•		
Arctic lubricants for cold climate	•		
Biodegradable hydraulic oil	•		
APPROVALS	EUROPE: EN280 - AUSTRALIA: AS1418 - CANADA: CS-B354		



**PLATFORM**  
BASKET



**PLATFORM BASKET**  
Via Montessori,1 - 42028 Poviglio - RE - Italy  
Tel. +39 0522 967666 - Fax +39 0522 967667  
info@platformbasket.com